

COMPONENTS

ILLUSTRATION

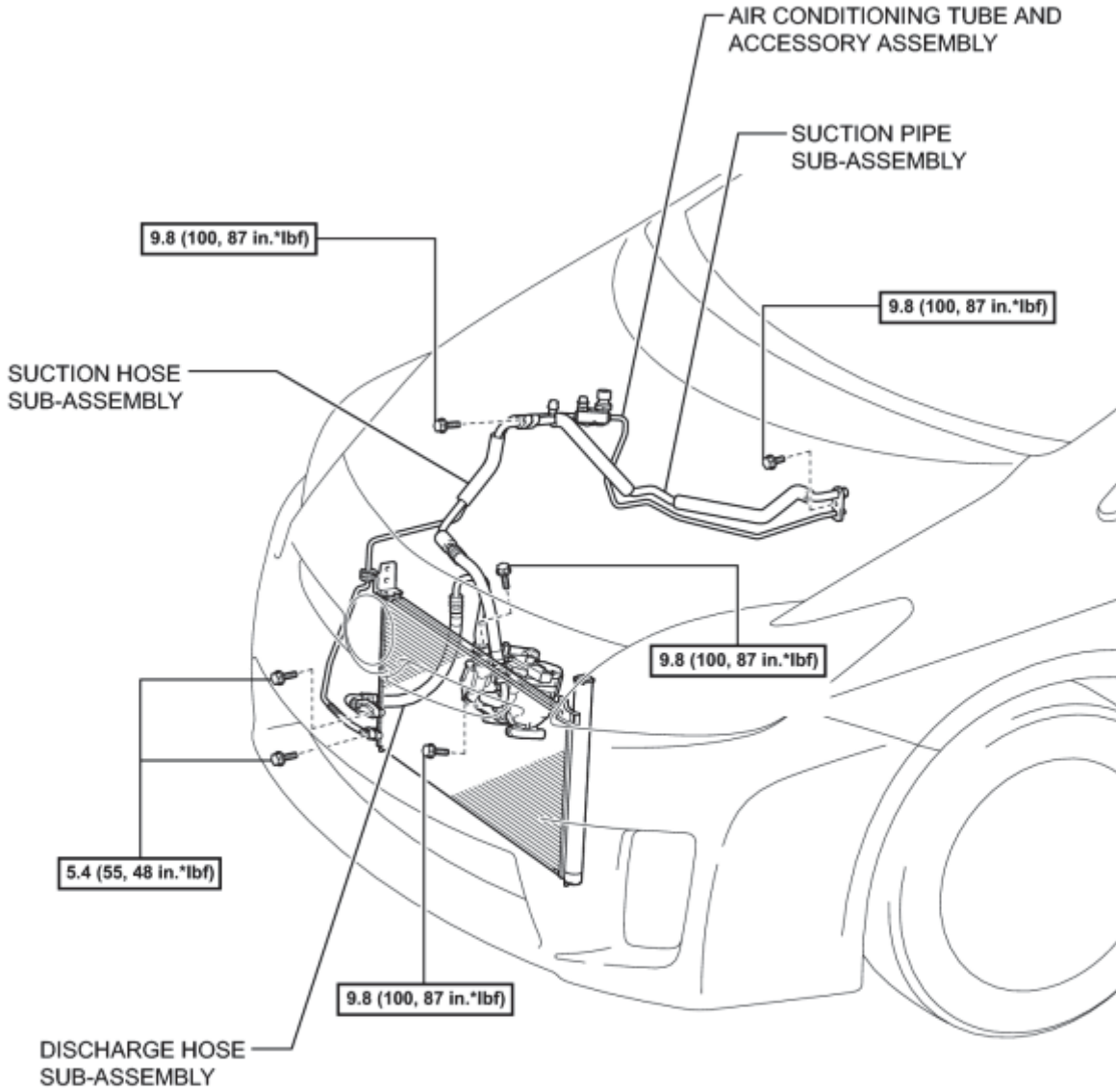

N*m (kgf*cm, ft.*lbf): Specified torque

P

ON-VEHICLE INSPECTION

1. INSPECT REFRIGERANT VOLUME

(a) Check the sight glass on the air conditioning tube and accessory.

(1) Prepare the vehicle according to the chart below.

Item	Condition
Vehicle door	Fully open
Temperature setting	MAX COOL
Blower speed	HI
A/C	on

(2) Compare the sight glass to the following chart.

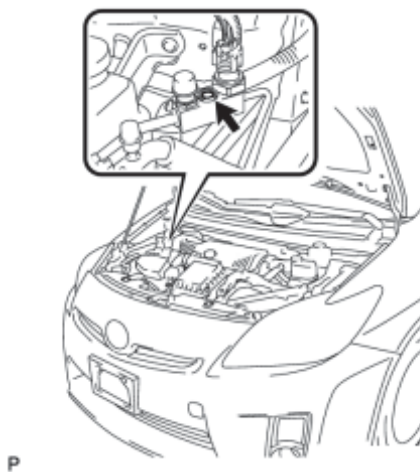

Item	Symptom	Amount of Refrigerant	Corrective Action
1	Bubbles exist	Insufficient*	<ol style="list-style-type: none"> 1. Check for gas leaks and repair if necessary 2. Recharge with a proper amount of refrigerant
2	No bubbles exist	Empty, insufficient, or excessive	Refer to 3 and 4
3	No temperature difference between compressor inlet and outlet	Empty or nearly empty	<ol style="list-style-type: none"> 1. Check for gas leaks and repair if necessary 2. Evacuate the AC system and recharge with a proper amount of refrigerant
4	Considerable temperature difference between compressor inlet and outlet	Proper or excessive	Refer to 5 and 6
5	Immediately after air conditioning is turned off, refrigerant remains clear	Excessive	<ol style="list-style-type: none"> 1. Recover refrigerant 2. Evacuate the AC system and recharge with a proper

			amount of refrigerant
6	Immediately after air conditioning is turned off, refrigerant foams and then becomes clear	Proper	-

*: Bubbles in the sight glass with the vehicle's interior temperature above 35°C (95°F) can be considered normal if cooling is sufficient.

2. INSPECT REFRIGERANT PRESSURE WITH MANIFOLD GAUGE SET

HINT:

This is a method where a manifold gauge set is used to help locate the problem.

(a) Read the manifold gauge pressure when the following conditions are met:

Test conditions:

- Temperature at the air inlet with the switch set at RECIRC is 30 to 35°C (86 to 95°F).
- The blower speed control switch position is at "HI".
- The temperature control dial position is at "COOL".
- The A/C switch is on.
- Doors are fully open.
- The power switch is in a position that enables the A/C compressor to run.

(1) Normally functioning refrigeration system

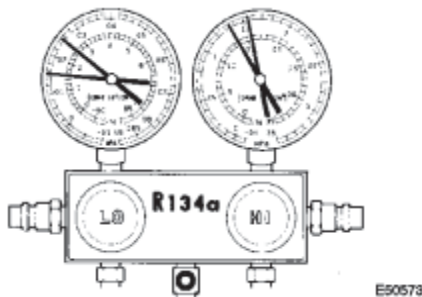

Gauge Reading

Pressure Side	Refrigerant Volume
Low	0.15 to 0.25 MPa (1.5 to 2.5 kgf/cm ² , 21 to 36 psi)
High	1.37 to 1.57 MPa (13.9 to 16.0 kgf/cm ² , 199 to 228 psi)

(2) Moisture is present in the refrigeration system.

Condition: Periodically cools and then fails to cool

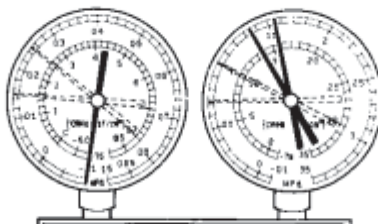

Symptom	Probable Cause	Diagnosis	Corrective Action
During operation, pressure on low pressure side cycles between normal and vacuum	<ul style="list-style-type: none"> Moisture in the AC system will freeze at the expansion valve orifice, causing the refrigeration cycle to temporarily stop After the system stops, and warms up again, the ice will melt and normal operation will be temporarily restored 	<ul style="list-style-type: none"> Cooler dryer (integrated into condenser tank) in oversaturated state Moisture in refrigeration system freezes at expansion valve orifice and blocks circulation of refrigerant 	<ol style="list-style-type: none"> Replace cooler dryer Remove moisture in system by repeatedly evacuating air Supply a proper amount of new refrigerant

(3) Insufficient cooling

Condition: Cooling system does not function effectively.

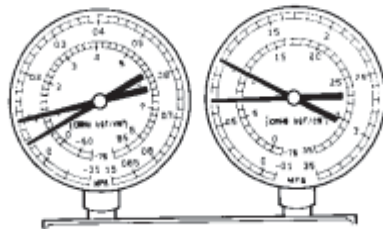

I22118

Symptom	Probable Cause	Diagnosis	Corrective Action
<ul style="list-style-type: none"> Pressure is low on both low and high pressure sides Bubbles are seen through sight glass continuously Insufficient cooling performance 	Gas leaks from the refrigeration system	<ul style="list-style-type: none"> Insufficient refrigerant Refrigerant leaking 	<ol style="list-style-type: none"> Check for gas leaks and repair if necessary Supply a proper amount of new refrigerant If the gauge indicates a pressure of close to 0, then it will be necessary to evacuate the system after repairing the leak

(4) Poor circulation of refrigerant

Condition: Cooling system does not function effectively.

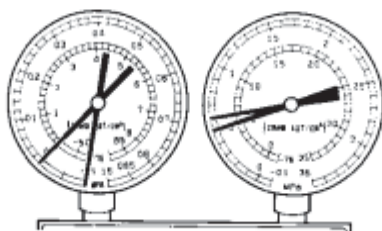

I22119

Symptom	Probable Cause	Diagnosis	Corrective Action
---------	----------------	-----------	-------------------

Symptom	Probable Cause	Diagnosis	Corrective Action
<ul style="list-style-type: none"> Pressure is low on both low and high pressure sides Frost exists on pipe from condenser to unit 	Refrigerant flow is obstructed by dirt inside the pipes of the condenser core	Receiver is clogged	Replace condenser

(5) Refrigerant does not circulate.

Condition: Cooling system does not function. (Sometimes it may function.)

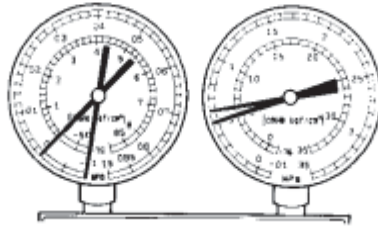

I22120

Symptom	Probable Cause	Diagnosis	Corrective Action
<ul style="list-style-type: none"> Vacuum is indicated on low pressure side and very low pressure is indicated on high pressure side Frost or condensation is seen on piping on both sides of receiver/drier or expansion valve 	<ul style="list-style-type: none"> Refrigerant flow is obstructed by moisture or dirt in refrigeration system Refrigerant flow is disrupted by gas leaks internally through the expansion valve 	Refrigerant does not circulate	<ol style="list-style-type: none"> Check expansion valve Replace expansion valve Replace condenser Evacuate air and supply a proper amount of new refrigerant For internal gas leaks at expansion valve, replace expansion valve

(6) Refrigerant is overcharged or cooling effectiveness of condenser is insufficient.

Condition: Cooling system does not function.

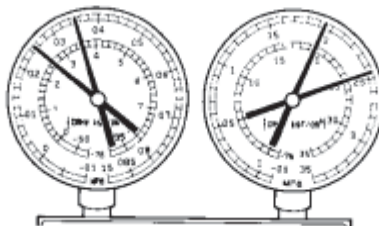

I22121

Symptom	Probable Cause	Diagnosis	Corrective Action
<ul style="list-style-type: none"> Pressure is too 	<ul style="list-style-type: none"> Unable to develop 	<ul style="list-style-type: none"> Excessive refrigerant 	<ol style="list-style-type: none"> Clean condenser

Symptom	Probable Cause	Diagnosis	Corrective Action
high on both low and high pressure sides <ul style="list-style-type: none"> No air bubbles are seen through sight glass even when compressor is on 	sufficient performance due to excessive use of refrigeration system <ul style="list-style-type: none"> Cooling effectiveness of condenser is insufficient 	in cycle → excessive refrigerant was added during recharging <ul style="list-style-type: none"> Condenser cooling effectiveness is insufficient → condenser fins are clogged at cooling fan 	<ol style="list-style-type: none"> Check the operation of the condenser cooling fan If 1 and 2 are normal state, check the amount of refrigerant and supply a proper amount of refrigerant

(7) Air is present in the refrigeration system.

Condition: Cooling system does not function.

NOTE: These gauge indications occur when the refrigeration system opens and the refrigerant is charged without vacuum purging.

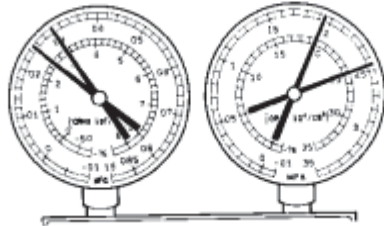

Symptom	Probable Cause	Diagnosis	Corrective Action
<ul style="list-style-type: none"> Pressure is too high on both low and high pressure sides The low pressure piping is too hot to touch Bubbles can be seen through sight glass 	Air in system	<ul style="list-style-type: none"> Air present in refrigeration system Insufficient vacuum purging 	<ol style="list-style-type: none"> Check compressor oil to see if it is dirty or insufficient Evacuate the system and recharge it with new or purified refrigerant

(8) Expansion valve malfunction

Condition: Insufficient cooling

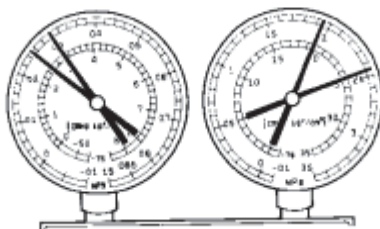

I22123

Symptom	Probable Cause	Diagnosis	Corrective Action
---------	----------------	-----------	-------------------

Symptom	Probable Cause	Diagnosis	Corrective Action
<ul style="list-style-type: none"> Pressure is too high on both low and high pressure sides Frost or a large amount of condensation on piping on low pressure side 	Expansion valve may be stuck	<ul style="list-style-type: none"> Excessive refrigerant in low pressure piping Expansion valve opened too wide 	Check expansion valve

(9) Insufficient compressor compression

Condition: Insufficient cooling

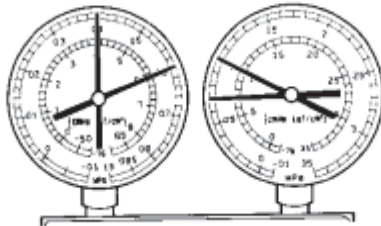

Symptom	Probable Cause	Diagnosis	Corrective Action
<ul style="list-style-type: none"> Pressure is too high on both low and high pressure sides Pressure is too low on high pressure side 	Internal leak in compressor	<ul style="list-style-type: none"> Low compression Leak from a damaged valve, or parts may be broken 	Replace compressor

Gauge readings (Reference)

Pressure on low pressure side

MPa (kgf/cm², psi)

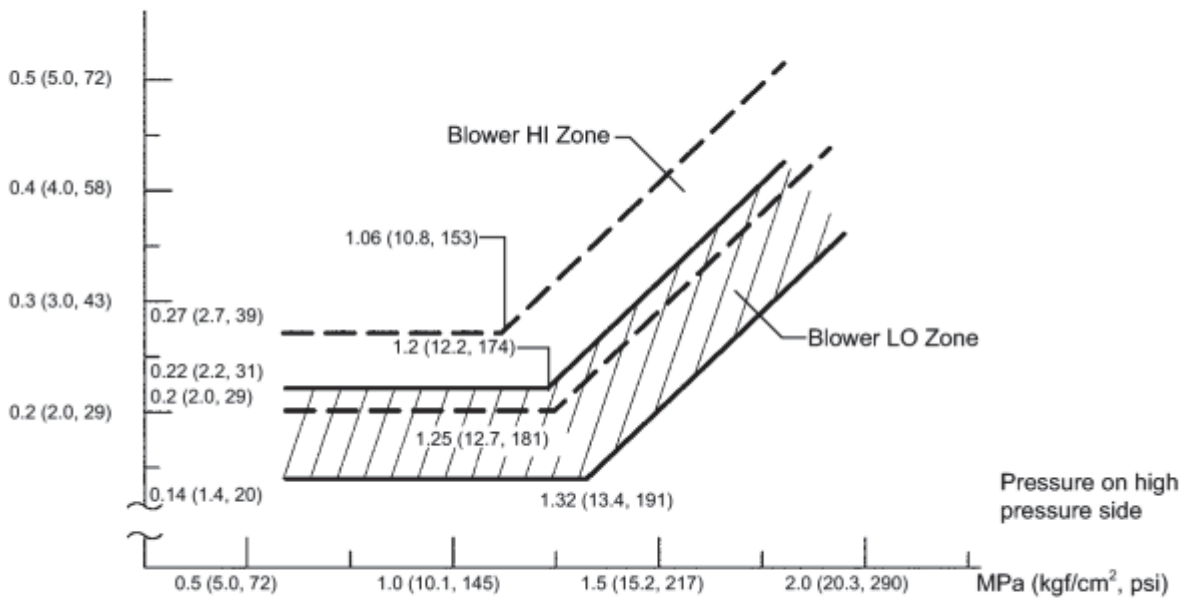

REPLACEMENT

1. RECOVER REFRIGERANT FROM REFRIGERATION SYSTEM

(a) Turn the A/C switch on.

(b) Operate the A/C with the setting temperature at 25°C (77°F) and the blower level at LO for 10 minutes to circulate the refrigerant. This causes most of the compressor oil from the various components of the A/C system to collect in the A/C compressor.

(c) Turn the power switch off.

(d) Recover the refrigerant from the A/C system using a refrigerant recovery unit.

2. CHARGE WITH REFRIGERANT

(a) Perform vacuum purging using a vacuum pump.

(b) Charge with refrigerant HFC-134a (R134a).

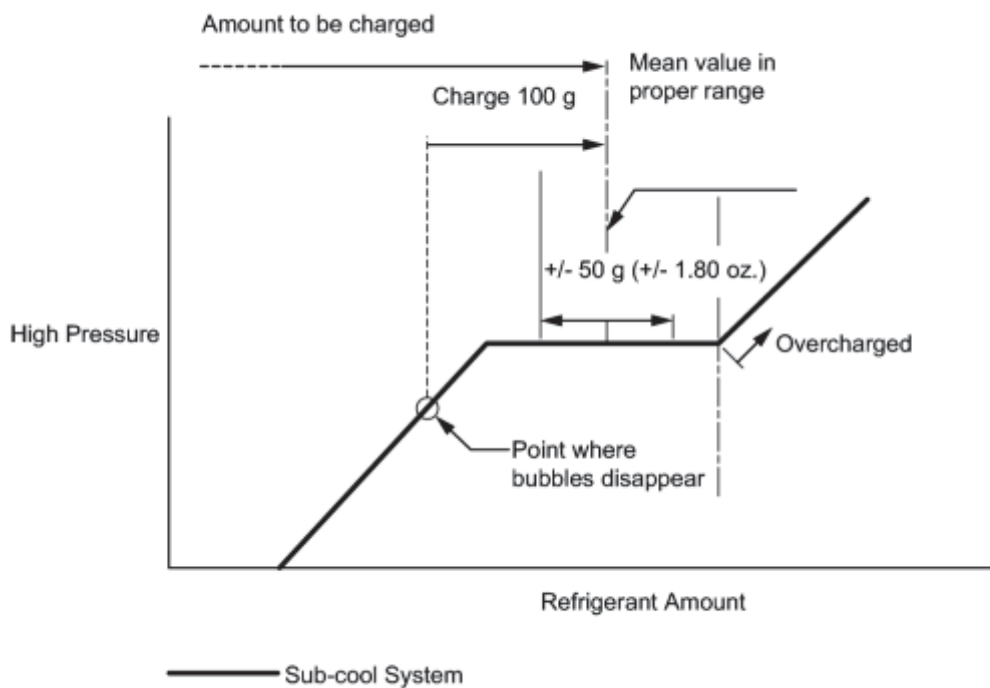

P

Standard:

470 g (16.6 oz.)

SST: 09985-20010

2010 Toyota Prius

Repair Manual

09985-02010

09985-02050

09985-02060

09985-02070

09985-02080

09985-02090

09985-02110

09985-02130

09985-02140

09985-02150

NOTICE:

- Do not turn the A/C on before charging with refrigerant. Doing so will cause the compressor to work without refrigerant, resulting in overheating of the cooler compressor.
- Approximately 100 g (3.53 oz.) of refrigerant may need to be charged after bubbles disappear. The refrigerant amount should be checked by quantity, not with the sight glass.
- Avoid using the gauge manifold set that had been used for vehicles with conventional compressor oil (ND-OIL11 or equivalent) as much as possible. This will cause compressor oil remaining in the manifold to enter the vehicle, resulting in insulation performance deterioration. A gauge manifold set that had been used 3 times or less can be reused if an appropriate one is not available.

HINT:

Ensure that sufficient refrigerant is available to recharge the system when using a refrigerant recovery unit. Refrigerant recovery units are not always able to recover 100% of the refrigerant from an A/C system.

3. WARM UP COMPRESSOR

- (a) Keep the A/C switch on for at least 2 minutes to warm up the compressor.

NOTICE:

Be sure to warm up the compressor when turning the A/C on after removing and installing the cooler refrigerant lines (including the compressor), to prevent damage to the compressor.

4. INSPECT FOR REFRIGERANT LEAK

- (a) After recharging with refrigerant, inspect for refrigerant leaks using a halogen leak detector.
- (b) Carry out the test under the following conditions:

- Turn the power switch off.
- Secure good ventilation (the halogen leak detector may react to volatile gases which are not refrigerant, such as evaporated gasoline and exhaust gas).
- Repeat the test 2 or 3 times.
- Make sure that there is some refrigerant remaining in the refrigeration system.

When the compressor is off: approx. 392 to 588 kPa (3.9 to 5.9 kgf/cm², 57 to 85 psi)

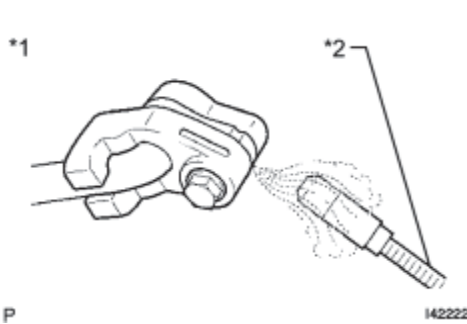

(c) Using a halogen leak detector, inspect for refrigerant leaks from the refrigerant lines.

Text in Illustration

*1	Inspect for Leak
*2	Halogen Leak Detector

(d) Bring the halogen leak detector close to the drain hose with the detector's power off, and then turn the detector on.

Text in Illustration

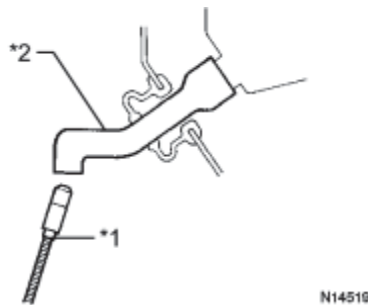

*1	Halogen Leak Detector
*2	Drain Hose

- After the blower motor has stopped, let the cooling unit stand for more than 15 minutes.
- Bring the halogen leak detector sensor under the drain hose.
- When bringing the halogen leak detector close to the drain hose, make sure that the halogen leak detector does not react to volatile gases. If it is not possible to avoid interference from volatile gases, the vehicle should be lifted up to allow testing.

(e) If a refrigerant leak is not detected from the drain hose, remove the blower motor control from the cooling unit. Insert the halogen leak detector sensor into the unit and perform the test.

(f) Disconnect the pressure switch connector and leave it for approximately 20 minutes. Bring the halogen leak detector close to the pressure switch and perform the test.