

**[N\*m (kgf\*cm, ft.\*lbf)]** : Specified torque

● Non-reusable part

← Lithium soap base glycol grease

c

## ILLUSTRATION

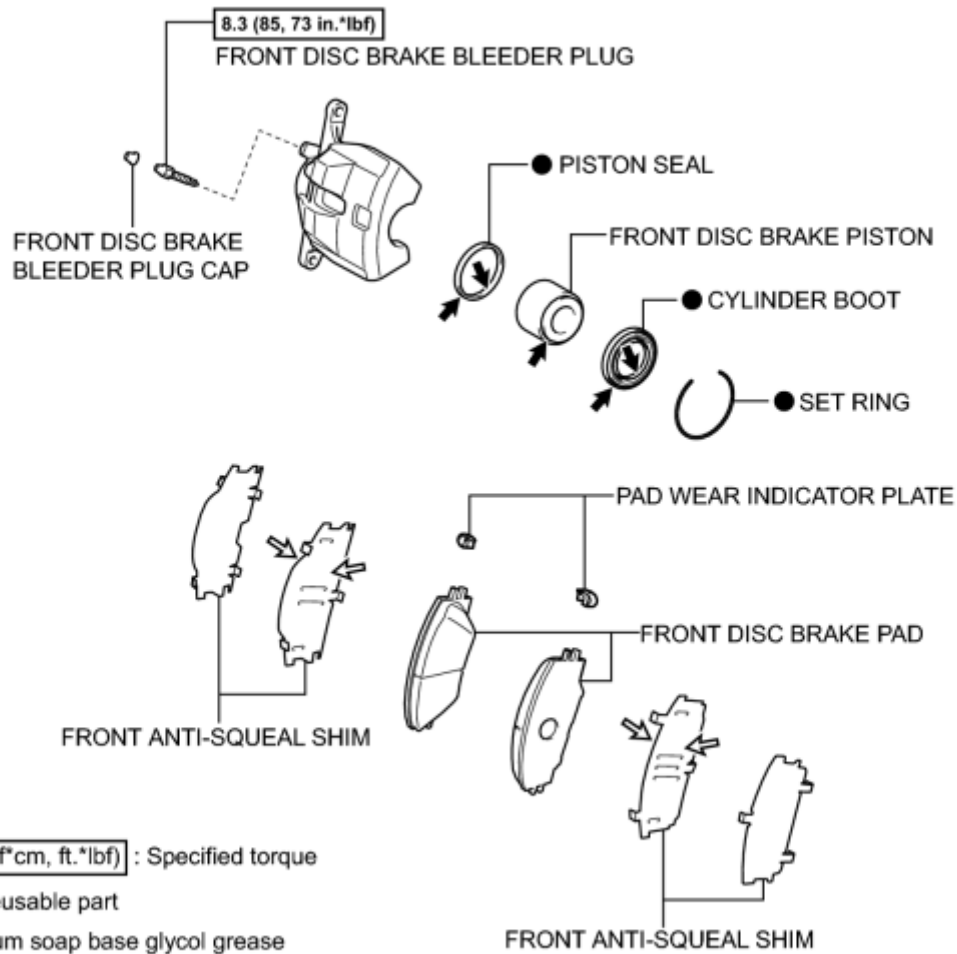

**N\*m (kgf\*cm, ft.\*lbf)** : Specified torque

● Non-reusable part

← Lithium soap base glycol grease

↶ Disc brake grease

c

# REMOVAL

## NOTICE:

When the brake pedal is first depressed after replacing the brake pads or pushing back the disc brake piston, DTC C1214 may be output. As there is no malfunction, clear the DTC.

## HINT:

- Use the same procedure for the LH side and RH side.
- The following procedure is for the LH side.

### 1. DISABLE BRAKE CONTROL INFO

### 2. REMOVE FRONT WHEEL

### 3. DRAIN BRAKE FLUID

## NOTICE:

If brake fluid leaks onto any painted surface, immediately wash it off.

### 4. SEPARATE FRONT FLEXIBLE HOSE

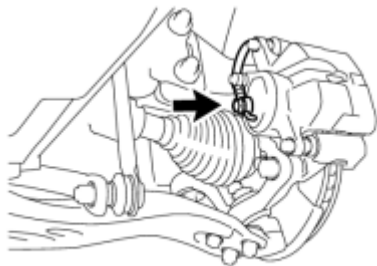

c

(a) Remove the union bolt and gasket, and separate the front flexible hose from the disc brake cylinder assembly.

### 5. REMOVE DISC BRAKE CYLINDER ASSEMBLY

(a) Hold the front disc brake cylinder slide pin, and remove the 2 bolts and disc brake cylinder assembly.

## Text in Illustration

\*1

Hold

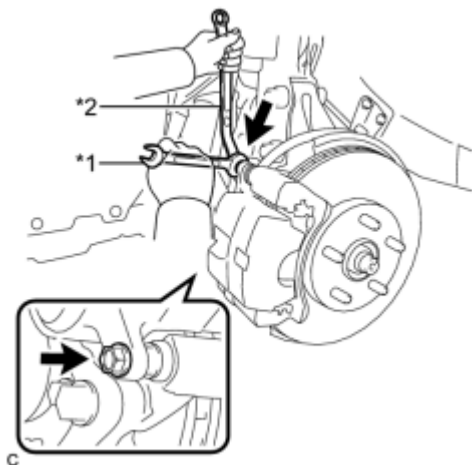

*2	Turn
----	------

## 6. REMOVE FRONT DISC BRAKE PAD

(a) Remove the 2 front disc brake pads from the front disc brake cylinder mounting.

## 7. REMOVE FRONT ANTI-SQUEAL SHIM

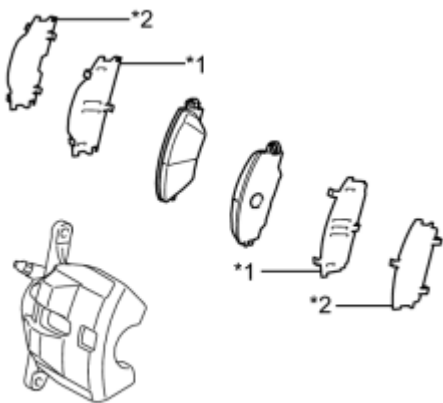

(a) Remove the front No. 1 anti-squeal shim and front No. 2 anti-squeal shim from each brake pad.

### Text in Illustration

*1	Front No. 1 Anti-squeal Shim
*2	Front No. 2 Anti-squeal Shim

(b) Remove the pad wear indicator plate from each front disc brake pad.

## 8. REMOVE FRONT DISC BRAKE PAD SUPPORT PLATE

(a) Remove the 2 front No. 1 disc brake pad support plates and 2 front No. 2 disc brake pad support plates from the front disc brake cylinder mounting.

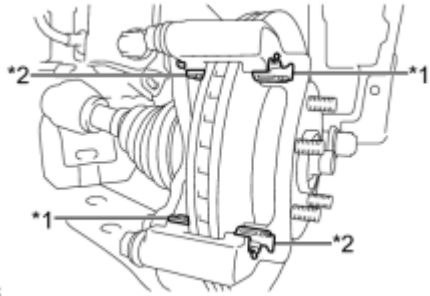

## Text in Illustration

*1	Front No. 1 Disc Brake Pad Support Plate
*2	Front No. 2 Disc Brake Pad Support Plate

### NOTICE:

Each front disc brake pad support plate has a different shape. Be sure to put an identification mark on each front disc brake pad support plate so that it can be reinstalled to its original position.

## 9. REMOVE FRONT NO. 1 DISC BRAKE CYLINDER SLIDE PIN

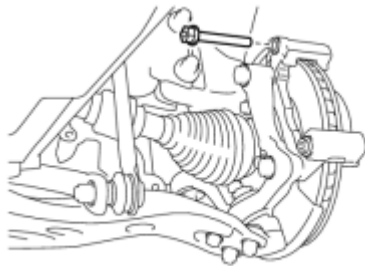

(a) Remove the front No. 1 disc brake cylinder slide pin from the front disc brake cylinder mounting.

## 10. REMOVE FRONT NO. 2 DISC BRAKE CYLINDER SLIDE PIN

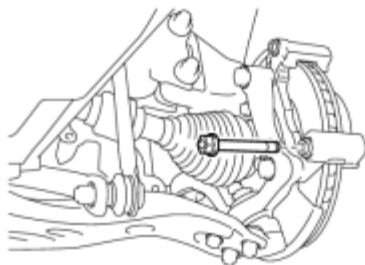

(a) Remove the front No. 2 disc brake cylinder slide pin from the front disc brake cylinder mounting.

## 11. REMOVE FRONT DISC BRAKE BUSHING DUST BOOT

(a) Remove the 2 front disc brake bushing dust boots from the front disc brake cylinder mounting.

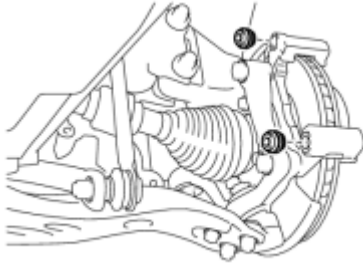

c

## 12. REMOVE FRONT DISC BRAKE CYLINDER MOUNTING

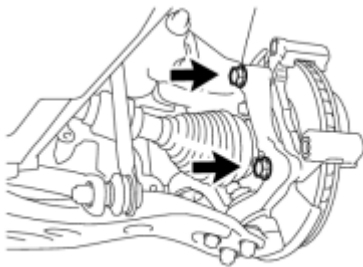

c

(a) Remove the 2 bolts and front disc brake cylinder mounting from the steering knuckle.

## 13. REMOVE FRONT DISC

(a) Remove the front disc.

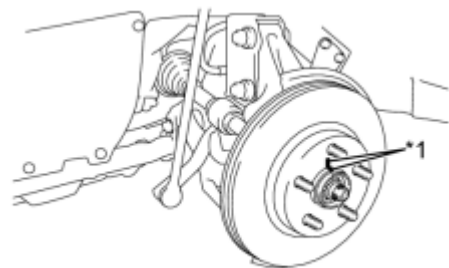

c

### **Text in Illustration**

*1	Matchmark
----	-----------

HINT:

Put matchmarks on the disc and the axle hub.

# DISASSEMBLY

## 1. REMOVE CYLINDER BOOT

(a) Using a screwdriver with its tip wrapped with vinyl tape, remove the set ring and cylinder boot from the disc brake cylinder assembly.

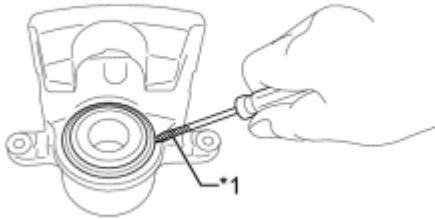

### Text in Illustration

*1	Vinyl Tape
----	------------

NOTICE:

Be careful not to damage the brake piston or cylinder.

## 2. REMOVE FRONT DISC BRAKE PISTON



(a) Place a piece of cloth between the front disc brake piston and disc brake cylinder assembly.

(b) Apply compressed air to remove the front disc brake piston from the disc brake cylinder assembly.

CAUTION:

Do not place your fingers in front of the piston when using compressed air.

NOTICE:

Do not allow any brake fluid to spatter.

## 3. REMOVE PISTON SEAL

(a) Using a screwdriver with its tip wrapped with vinyl

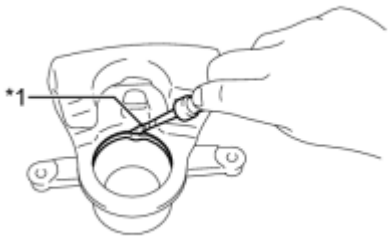

P

tape, remove the piston seal from the disc brake cylinder assembly.

## Text in Illustration

*1	Vinyl Tape
----	------------

NOTICE:

Do not damage the inner surface or piston seal groove of the cylinder.

4. REMOVE FRONT DISC BRAKE BLEEDER PLUG CAP

5. REMOVE FRONT DISC BRAKE BLEEDER PLUG



# INSPECTION

## 1. INSPECT BRAKE CYLINDER AND PISTON

(a) Check the cylinder bore and piston for rust and scoring. If necessary, replace the disc brake cylinder and piston.

## 2. INSPECT PAD LINING THICKNESS

(a) Using a ruler, measure the pad lining thickness.

### Text in Illustration

*1	Ruler
----	-------

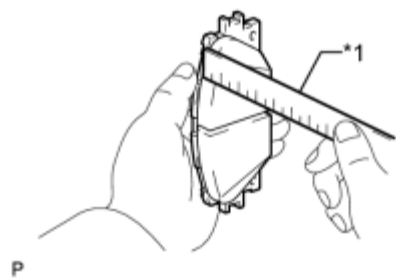

Standard thickness:

10.0 mm (0.394 in.)

Minimum thickness:

1.0 mm (0.0394 in.)

If the pad lining thickness is less than the minimum thickness, replace the disc brake pads.

HINT:

Be sure to check the wear of the front disc after replacing the brake pads with new ones.

## 3. INSPECT FRONT DISC BRAKE PAD SUPPORT PLATE

(a) Make sure that the front disc brake pad support plates have sufficient rebound, no deformation, cracks or wear, and that all rust and dirt are cleaned off. If necessary, replace the front disc brake pad support plates.

## 4. INSPECT DISC THICKNESS

(a) Using a micrometer, measure the disc thickness.

### Text in Illustration

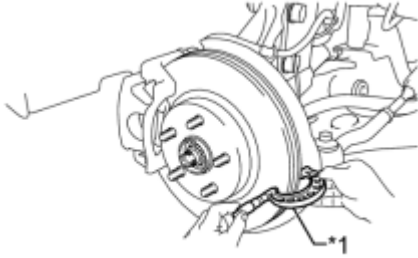

*1	Micrometer
----	------------

Standard thickness:

25.0 mm (0.984 in.)

Minimum thickness:

22.0 mm (0.866 in.)

If the disc thickness is less than the minimum, replace the front disc.

c

## 5. INSPECT DISC RUNOUT

(a) Inspect the front axle hub bearing looseness and front axle hub runout INFO.

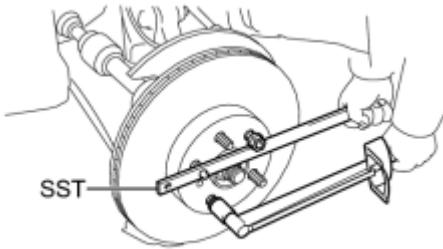

(b) Using SST to hold the disc, tighten the disc with the 5 nuts.

SST: 09330-00021

Torque: **103 N·m (1050 kgf·cm, 76ft·lbf)**

c

(c) Using a dial indicator, measure the disc runout 10 mm (0.394 in.) away from the outer edge of the front disc.

## Text in Illustration

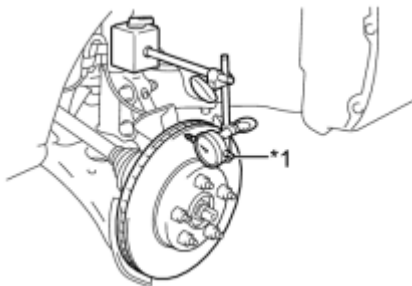

*1	Dial Indicator
----	----------------

Maximum disc runout:

0.05 mm (0.00197 in.)

NOTICE:

Keep the magnet of the dial indicator away from the axle hub and speed sensor.

c

If the runout exceeds the maximum value, change the installation position of the disc to minimize the runout. If the runout exceeds the maximum even when the installation position is changed, grind the disc. If the disc thickness is less than the minimum, replace the front disc.

(d) Remove the 5 nuts and front disc.

# REASSEMBLY

## 1. TEMPORARILY TIGHTEN FRONT DISC BRAKE BLEEDER PLUG

HINT:

Fully tighten the front disc brake bleeder plug after bleeding any air left in the system.

## 2. INSTALL FRONT DISC BRAKE BLEEDER PLUG CAP

## 3. INSTALL PISTON SEAL



(a) Apply a light layer of lithium soap base glycol grease to the entire circumference of a new piston seal.

 Lithium soap base glycol grease

c

(b) Install the piston seal to the disc brake cylinder assembly.

NOTICE:

Securely install the piston seal into the groove of the disc brake cylinder.

## 4. INSTALL FRONT DISC BRAKE PISTON

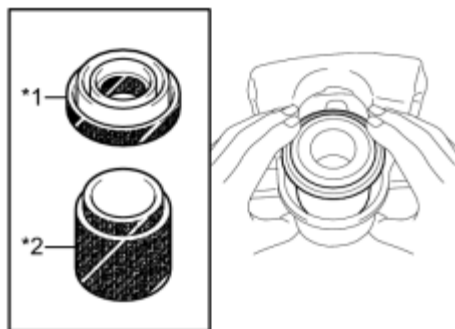

 Lithium soap base glycol grease

c

(a) Apply a light layer of lithium soap base glycol grease to the entire circumference of a new cylinder boot.

### Text in Illustration

*1	Cylinder Boot
*2	Front Disc Brake Piston

(b) Install the cylinder boot to the front disc brake piston.

(c) Apply a light layer of lithium soap base glycol grease to the contact surfaces of the front disc brake piston, and install it to the disc brake cylinder assembly.

NOTICE:

Do not install the piston forcibly in the disc brake cylinder assembly.

## 5. INSTALL CYLINDER BOOT

(a) Install the cylinder boot to the disc brake cylinder assembly.

### Text in Illustration

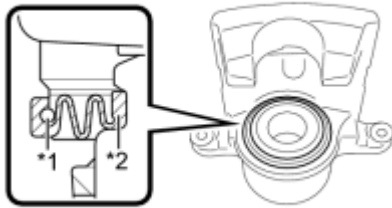

*1	Set Ring
*2	Cylinder Boot

NOTICE:

Securely install the cylinder boot to the groove of the disc brake cylinder assembly and front disc brake piston.

(b) Using a screwdriver with its tip wrapped with vinyl tape, install a new set ring.

### Text in Illustration

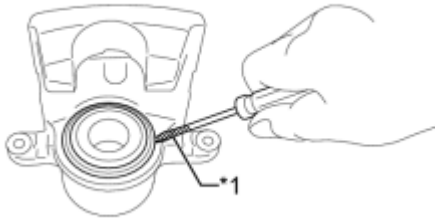

*1	Vinyl Tape
----	------------

- Securely install the set ring to the outer groove of the cylinder boot.
- Do not damage the cylinder boot.

# INSTALLATION

## HINT:

- Use the same procedure for the LH side and RH side.
- The following procedure is for the LH side.

### 1. INSTALL FRONT DISC

- (a) Align the matchmarks of the disc and axle hub, and install the disc.

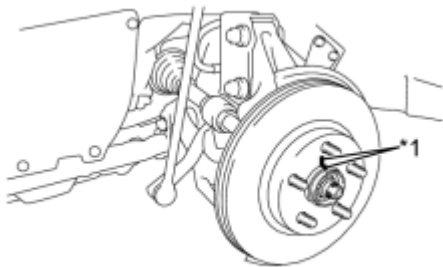

## Text in Illustration

*1	Matchmark
----	-----------

## NOTICE:

When replacing the disc with a new one, select the installation position where the front disc has minimal runout.

### 2. INSTALL FRONT DISC BRAKE CYLINDER MOUNTING

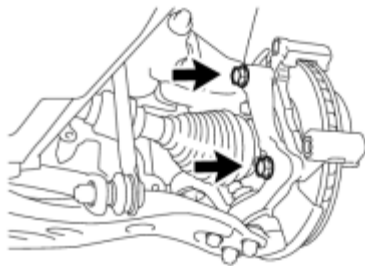

- (a) Install the front disc brake cylinder mounting to the steering knuckle with the 2 bolts.

**Torque: 137 N·m (1394 kgf·cm, 101ft·lbf)**

### 3. INSTALL FRONT DISC BRAKE BUSHING DUST BOOT

- (a) Apply a light layer of lithium soap base glycol grease to the entire circumference of 2 new front disc brake bushing dust boots.

## HINT:

Apply at least 0.3 g (0.01 oz.) of lithium soap base glycol

grease to each front disc brake bushing dust boot.

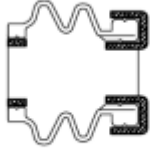

 Lithium soap base glycol grease

c

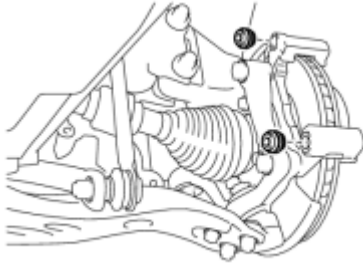

(b) Install the 2 front disc brake bushing dust boots to the front disc brake cylinder mounting.

c

#### 4. INSTALL FRONT NO. 2 DISC BRAKE CYLINDER SLIDE PIN



(a) Apply a light layer of lithium soap base glycol grease to the sliding part and the seal surface of the front No. 2 disc brake cylinder slide pin.

 Lithium soap base glycol grease

c

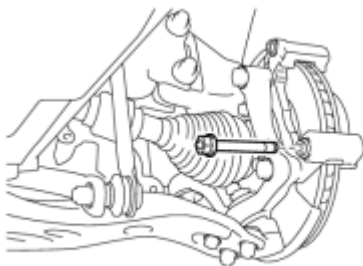

(b) Install the front No. 2 disc brake cylinder slide pin to the front disc brake cylinder mounting.

c

(c) Push the front No. 2 disc brake cylinder slide pin into the front disc brake bushing dust boot to align them.

#### 5. INSTALL FRONT NO. 1 DISC BRAKE CYLINDER SLIDE PIN



(a) Apply a light layer of lithium soap base glycol grease to the sliding part and the seal surface of the front No. 1 disc brake cylinder slide pin.

 Lithium soap base glycol grease

c

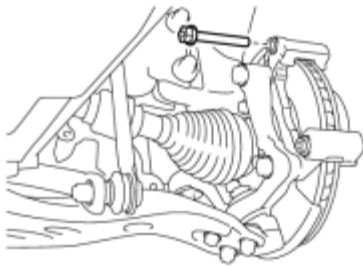

(b) Install the front No. 1 disc brake cylinder slide pin to the front disc brake cylinder mounting.

c

(c) Push the front No. 1 disc brake cylinder slide pin into the front disc brake bushing dust boot to align them.

## 6. INSTALL FRONT DISC BRAKE PAD SUPPORT PLATE

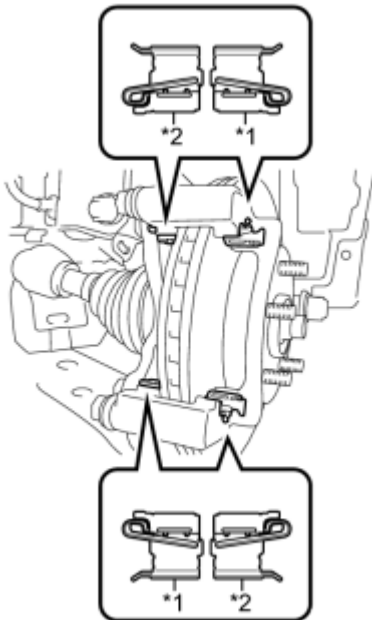

c

(a) Install the 2 front No. 1 disc brake pad support plates and 2 front No. 2 disc brake pad support plates to the front disc brake cylinder mounting.

### Text in Illustration

*1	Front No. 1 Disc Brake Pad Support Plate
*2	Front No. 2 Disc Brake Pad Support Plate

### NOTICE:

Be sure to install each front disc brake pad support plate in the correct position and direction.

## 7. INSTALL FRONT ANTI-SQUEAL SHIM



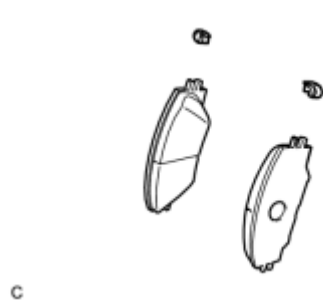

(a) Install the pad wear indicator plate to each front disc brake pad.

NOTICE:

Install each pad wear indicator plate in the correct position and direction.

Inner:

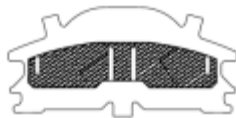

Outer:

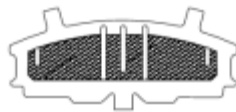

 Disc brake grease

(b) Apply disc brake grease to both sides of each front No. 1 anti-squeal shim as shown in the illustration.

- When replacing worn pads, the front anti-squeal shims must be replaced together with the pads.
- Apply disc brake grease to the area that contacts the anti-squeal shims.

(c) Install the front No. 1 anti-squeal shim and front No. 2 anti-squeal shim to each front disc brake pad.

### Text in Illustration

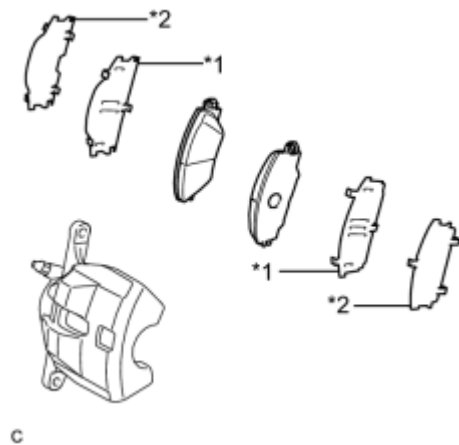

*1	Front No. 1 Anti-squeal Shim
*2	Front No. 2 Anti-squeal Shim

- Install the shims in the correct positions and directions.
- Disc brake grease can seep out slightly from the area where the anti-squeal shim is installed.
- Make sure that disc brake grease is not applied onto the lining surface.

## 8. INSTALL FRONT DISC BRAKE PAD

(a) Install the 2 front disc brake pads to the front disc brake cylinder mounting.

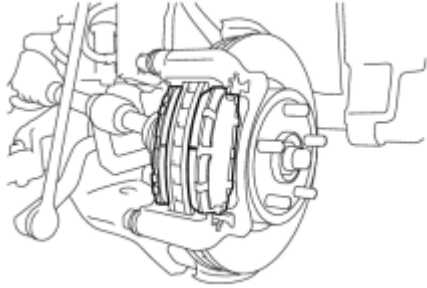

**NOTICE:**

There should be no oil or grease on the friction surfaces of the disc brake pads or the front disc.

c

**9. INSTALL DISC BRAKE CYLINDER ASSEMBLY**

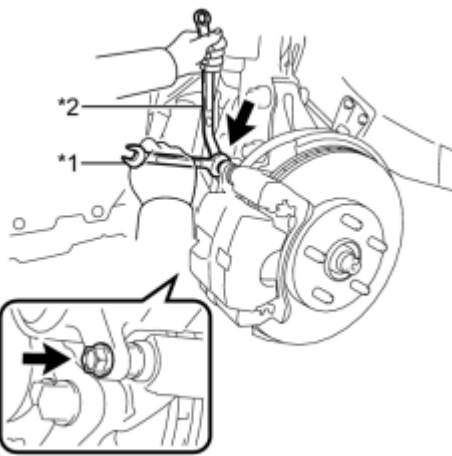

(a) Hold the front disc brake cylinder slide pin, and install the disc brake cylinder assembly to the front disc brake cylinder mounting with the 2 bolts.

**Text in Illustration**

*1	Hold
*2	Turn

**Torque: 34 N·m (347 kgf·cm, 25ft·lbf)**

c

**10. CONNECT FRONT FLEXIBLE HOSE**

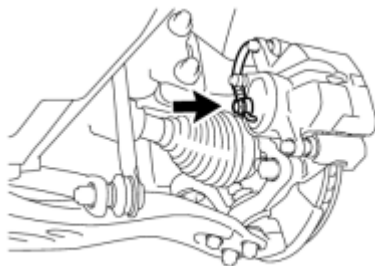

(a) Connect the front flexible hose to the disc brake cylinder assembly with a new union bolt and a new gasket.

**Torque: 33 N·m (340 kgf·cm, 25ft·lbf)**

**HINT:**

Install the flexible hose lock securely into the lock hole in the disc brake cylinder.

c

**11. BLEED BRAKE LINE** INFO

**12. PERFORM INITIALIZATION AND CALIBRATION OF LINEAR SOLENOID VALVE**

**HINT:**

If the brake control has been disabled, make sure to perform initialization and calibration of the linear solenoid valve .

### 13. INSTALL FRONT WHEEL

Torque: **103 N·m (1050 kgf·cm, 76ft·lbf)**

## COMPONENTS

## ILLUSTRATION

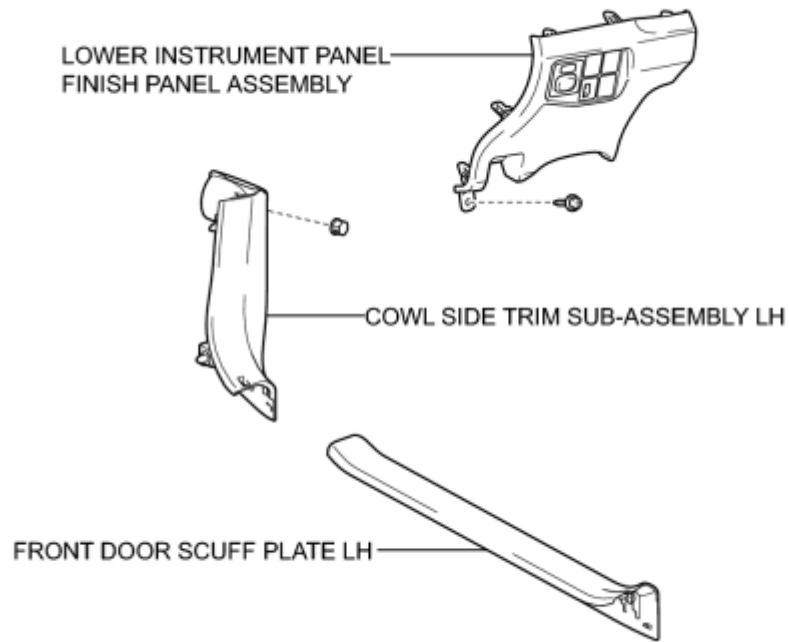

c

## ILLUSTRATION

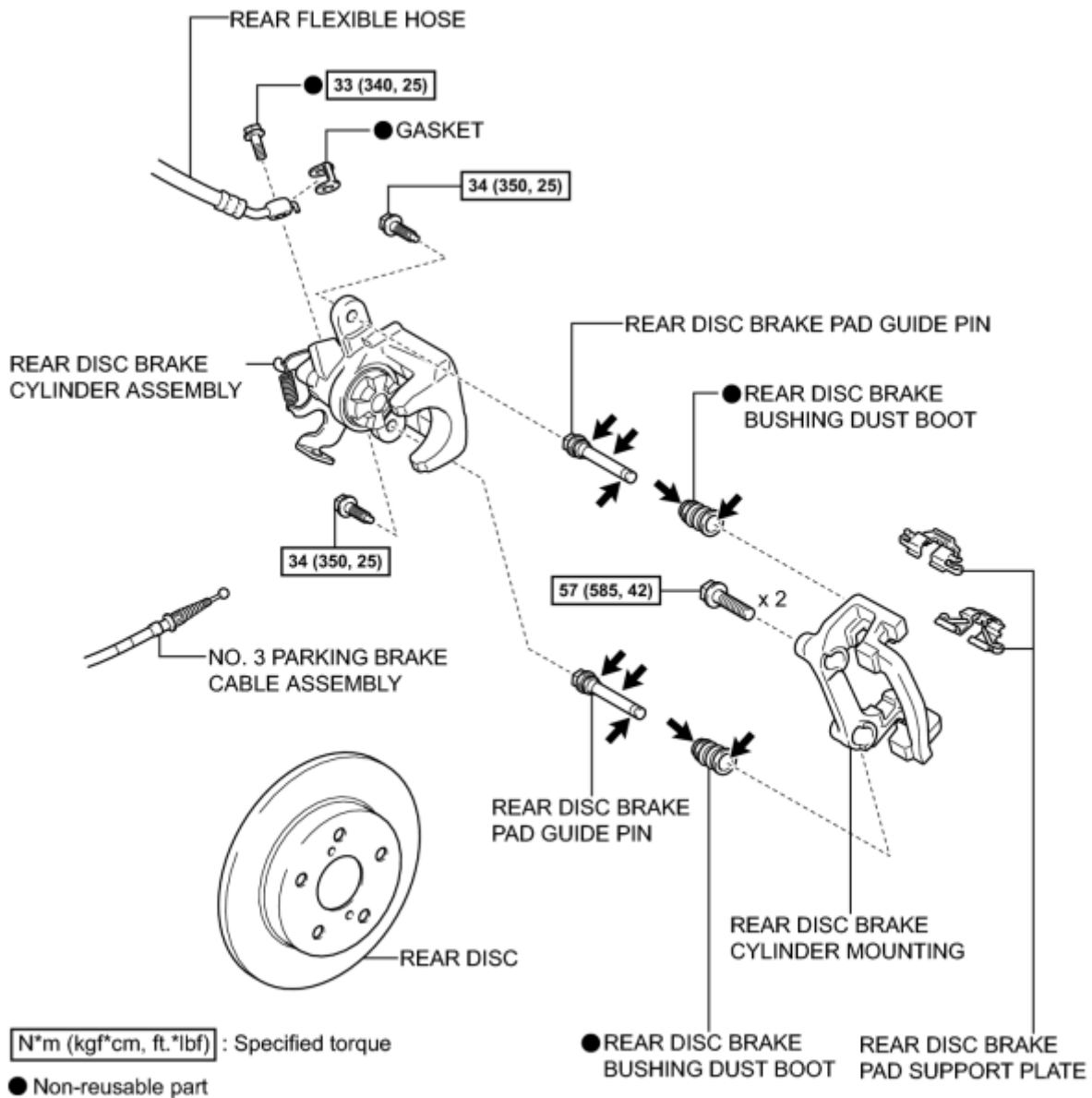

c

## ILLUSTRATION

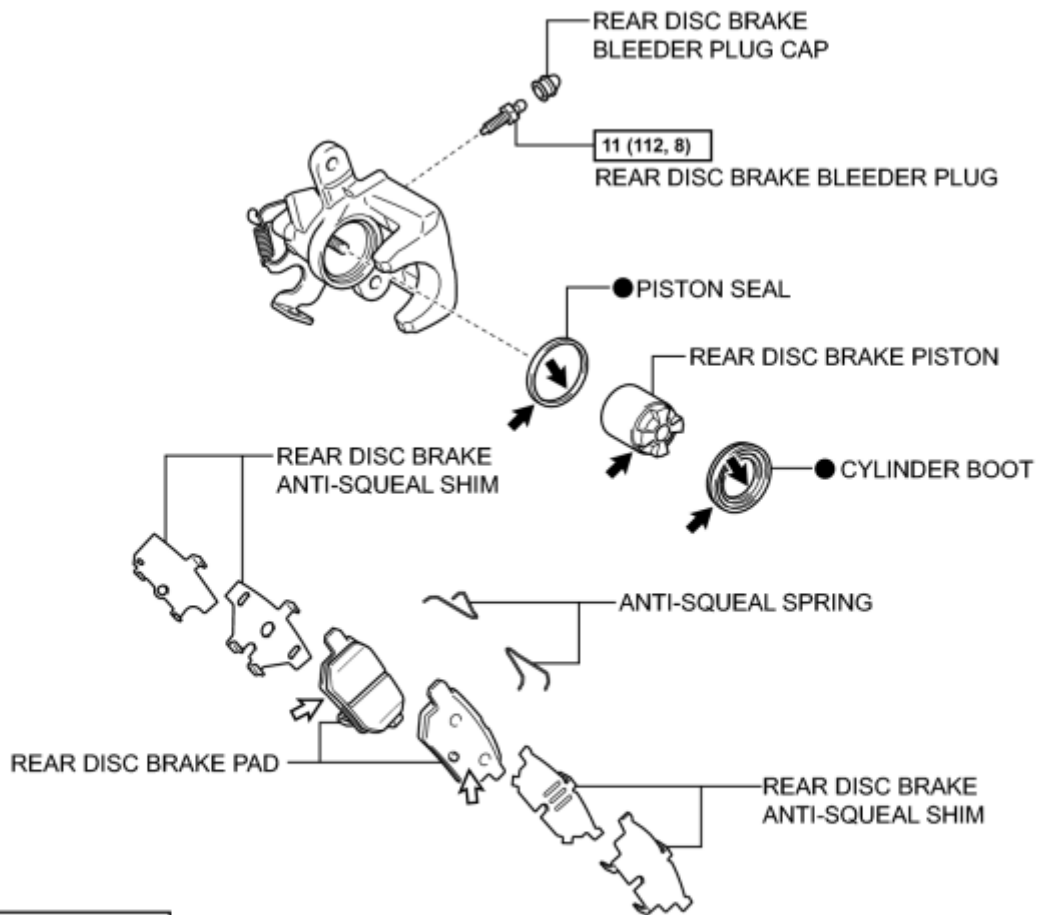

**N\*m (kgf\*cm, ft.\*lbf)** : Specified torque

● Non-reusable part

◀ Lithium soap base glycol grease

↔ Disc brake grease

c

# REMOVAL

## NOTICE:

When the brake pedal is first depressed after replacing the brake pads or pushing back the disc brake piston, DTC C1214 may be output. As there is no malfunction, clear the DTC.

## HINT:

- Use the same procedure for the LH side and RH side.
- The following procedure is for the LH side.

1. DISABLE BRAKE CONTROL INFO

2. REMOVE REAR WHEEL

3. DRAIN BRAKE FLUID

## NOTICE:

If brake fluid leaks onto any painted surface, immediately wash it off.

4. REMOVE FRONT DOOR SCUFF PLATE LH INFO

5. REMOVE COWL SIDE TRIM SUB-ASSEMBLY LH INFO

6. REMOVE LOWER INSTRUMENT PANEL FINISH PANEL ASSEMBLY INFO

7. LOOSEN PARKING BRAKE CABLE

(a) Completely release the parking brake pedal.

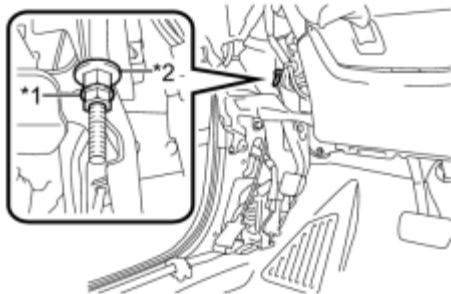

(b) Loosen the lock nut and adjusting nut to completely release the parking brake cable.

## Text in Illustration

*1	Lock Nut
*2	Adjusting Nut

8. DISCONNECT NO. 3 PARKING BRAKE CABLE ASSEMBLY

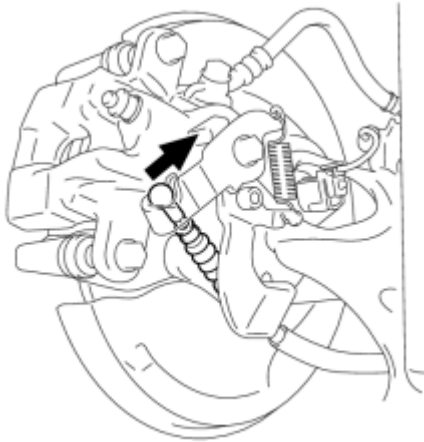

(a) Separate the No. 3 parking brake cable assembly from the rear disc brake cylinder assembly.

c

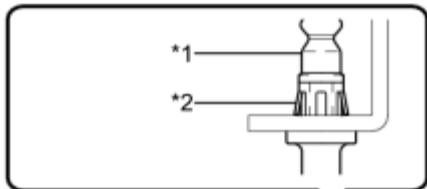

(b) Separate the No. 3 parking brake cable assembly from the rear disc brake cylinder assembly.

### Text in Illustration

*1	No. 3 Parking Brake Cable Assembly
*2	Clip
*3	Offset Wrench (14 mm)

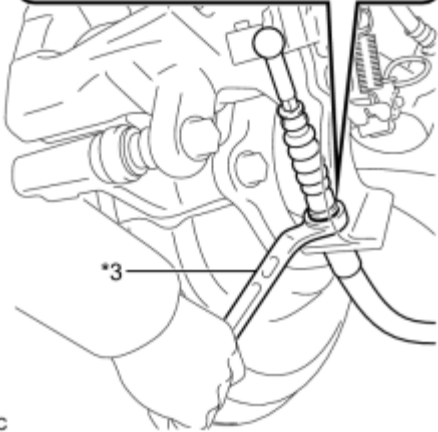

HINT:

Insert an offset wrench (14 mm) at the base of the No. 3 parking brake cable assembly as shown in the illustration to disengage the clip. Pull out the No. 3 parking brake cable assembly from the rear disc brake cylinder assembly.

c

## 9. SEPARATE REAR FLEXIBLE HOSE

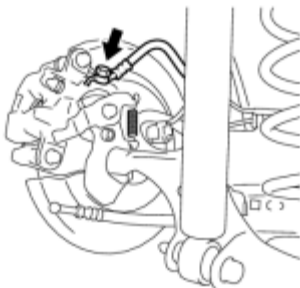

(a) Remove the union bolt and gasket, and separate the rear flexible hose from the rear disc brake cylinder assembly.

c



## 10. REMOVE REAR DISC BRAKE CYLINDER ASSEMBLY

(a) Hold the rear disc brake pad guide pin, and remove the 2 bolts and rear disc brake cylinder assembly.

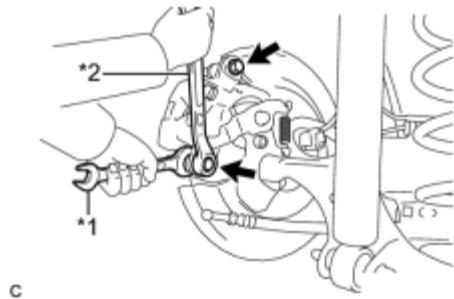

### Text in Illustration

*1	Hold
*2	Turn

#### NOTICE:

Remove the rear disc brake cylinder assembly while holding both of the rear disc brake pads because the anti-squeal springs may fall off the rear disc brake pads.

## 11. REMOVE REAR DISC BRAKE PAD

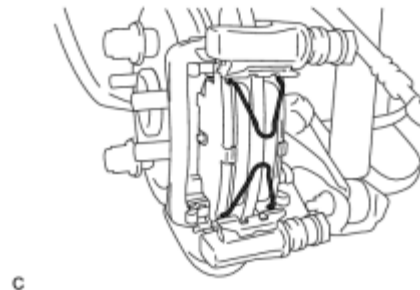

(a) Remove the 2 anti-squeal springs from the rear disc brake pads.

(b) Remove the 2 rear disc brake pads from the rear disc brake cylinder mounting.

## 12. REMOVE REAR DISC BRAKE ANTI-SQUEAL SHIM

(a) Remove the rear No. 1 disc brake anti-squeal shim and rear No. 2 disc brake anti-squeal shim from each rear disc brake pad.

### Text in Illustration

*1	Rear No. 1 Disc Brake Anti-squeal Shim
*2	Rear No. 2 Disc Brake Anti-squeal Shim

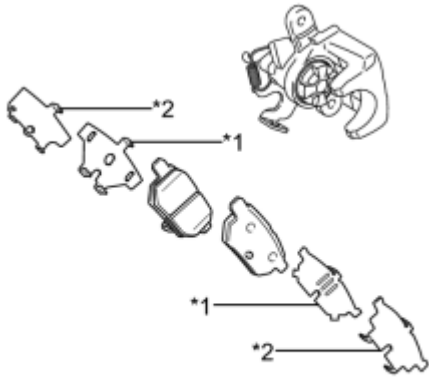

c

### 13. REMOVE REAR DISC BRAKE PAD SUPPORT PLATE

(a) Remove the 2 rear disc brake pad support plates from the disc brake cylinder mounting.

NOTICE:

Each rear disc brake pad support plate has a different shape. Be sure to put an identification mark on each rear disc brake pad support plate so that it can be installed to its original position.



y

### 14. REMOVE REAR DISC BRAKE PAD GUIDE PIN

(a) Remove the 2 rear disc brake pad guide pins from the rear disc brake cylinder mounting.

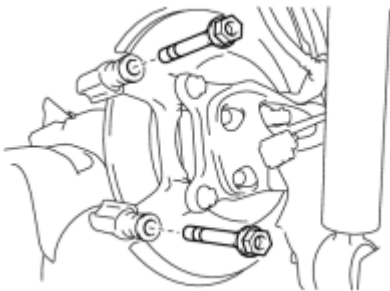

### 15. REMOVE REAR DISC BRAKE BUSHING DUST BOOT

(a) Remove the 2 rear disc brake bushing dust boots from the rear disc brake cylinder mounting.



16. REMOVE REAR DISC BRAKE CYLINDER MOUNTING

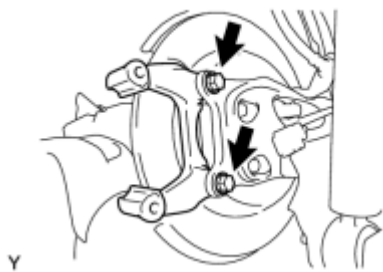

(a) Remove the 2 bolts and rear disc brake cylinder mounting from the axle beam.

17. REMOVE REAR DISC



(a) Remove the rear disc.

**Text in Illustration**

*1	Matchmark
----	-----------

HINT:

Place matchmarks on the disc and axle hub.

# DISASSEMBLY

## 1. REMOVE REAR DISC BRAKE PISTON

(a) Using SST, remove the rear disc brake piston by turning it counterclockwise.

SST: 09960-10010

09963-00400



- Do not damage the piston.
- Do not allow any brake fluid to spatter.

## 2. REMOVE CYLINDER BOOT

(a) Remove the cylinder boot from the rear disc brake piston.

## 3. REMOVE PISTON SEAL

(a) Using a screwdriver with its tip wrapped with vinyl tape, remove the piston seal from the rear disc brake cylinder assembly.

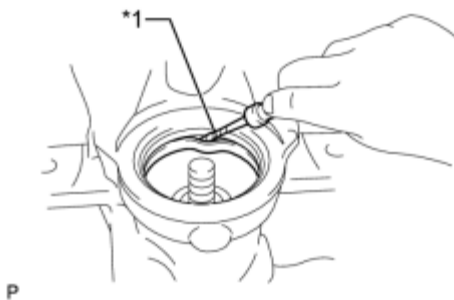

### Text in Illustration

*1	Vinyl Tape
----	------------

NOTICE:

Do not damage the inner surface or piston seal groove of the cylinder.

## 4. REMOVE REAR DISC BRAKE BLEEDER PLUG CAP

## 5. REMOVE REAR DISC BRAKE BLEEDER PLUG

# INSPECTION

## 1. INSPECT BRAKE CYLINDER AND PISTON

(a) Check the cylinder bore and piston for rust and scoring. If necessary, replace the disc brake cylinder and piston.

## 2. INSPECT PAD LINING THICKNESS

(a) Using a ruler, measure the pad lining thickness.

### Text in Illustration

*1	Ruler
----	-------

Standard thickness:

9.5 mm (0.374 in.)

Minimum thickness:

1.0 mm (0.0394 in.)

If the pad lining thickness is equal to the minimum thickness or less, replace the brake pads with a disc brake pad kit.

HINT:

Be sure to check the wear of the rear disc after replacing the brake pads with new ones.

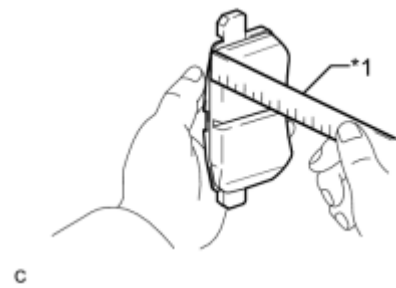

## 3. INSPECT REAR DISC BRAKE PAD SUPPORT PLATE

(a) Make sure that the rear disc brake pad support plates have sufficient rebound, no deformation, cracks or wear, and that all rust and dirt are removed. If necessary, replace the rear disc brake pad support plates.

## 4. INSPECT DISC THICKNESS

(a) Using a micrometer, measure the disc thickness.

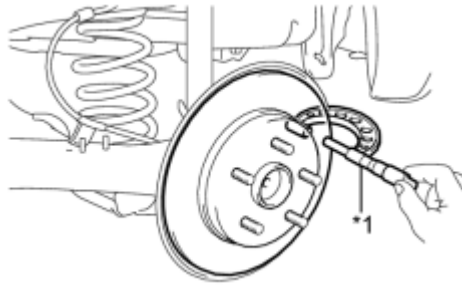

## Text in Illustration

*1	Micrometer
----	------------

Standard thickness:

9.0 mm (0.354 in.)

Minimum thickness:

7.5 mm (0.295 in.)

If the disc thickness is less than the minimum, replace the rear disc.

## 5. INSPECT DISC RUNOUT

(a) Inspect the rear axle hub bearing looseness and axle hub runout INFO.

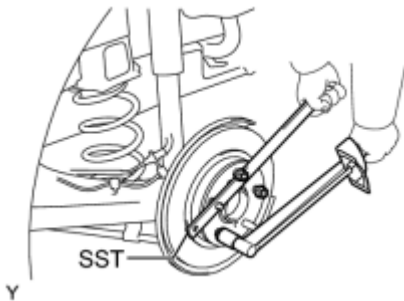

(b) While holding the disc using SST, tighten the disc with the 5 hub nuts.

SST: 09330-00021

Torque: **103 N·m (1050 kgf·cm, 76ft·lbf)**

(c) Using a dial indicator with magnetic base, measure the disc runout 10 mm (0.394 in.) away from the outer edge of the rear disc.

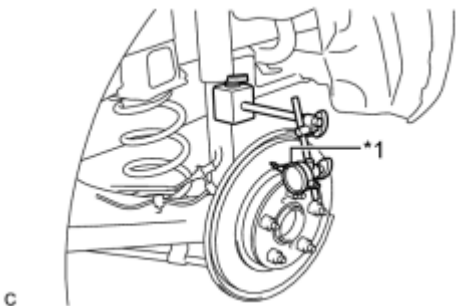

## Text in Illustration

*1	Dial Indicator
----	----------------

Maximum disc runout:

0.15 mm (0.00591 in.)

NOTICE:

Keep the magnet of the dial indicator away from the axle hub and speed sensor.

If the runout exceeds the maximum value, change the installation position of the disc to minimize the runout. If the runout exceeds the maximum even when the installation position is changed, grind the disc. If the disc thickness is less than the minimum, replace the rear disc.

(d) Remove the 5 nuts and rear disc.

## REASSEMBLY

### 1. TEMPORARILY TIGHTEN REAR DISC BRAKE BLEEDER PLUG

HINT:

Fully tighten the rear disc brake bleeder plug after bleeding any air left in the system.

### 2. INSTALL REAR DISC BRAKE BLEEDER PLUG CAP

### 3. INSTALL PISTON SEAL



(a) Apply a light layer of lithium soap base glycol grease to the entire circumference of a new piston seal.

 Lithium soap base glycol grease

c

(b) Install the piston seal to the rear disc brake cylinder assembly.

NOTICE:

Securely install the piston seal to the groove of the rear disc brake cylinder assembly.

### 4. INSTALL CYLINDER BOOT

(a) Apply a light layer of lithium soap base glycol grease to the entire circumference of the rear disc brake piston and a new cylinder boot.





(b) Install the cylinder boot to the piston as shown in the illustration.

NOTICE:

Do not install the cylinder boot after installing the piston into the disc brake cylinder.

#### 5. INSTALL REAR DISC BRAKE PISTON

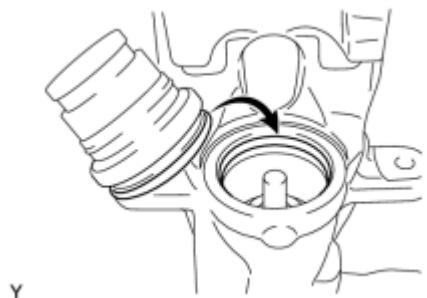

(a) Install the seal portion of the cylinder boot into the groove portion of the rear disc brake cylinder assembly.

NOTICE:

Securely install the cylinder boot to the groove of the rear disc brake cylinder assembly.

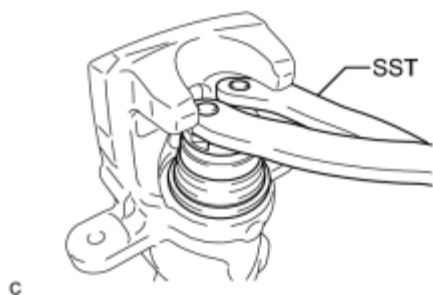

(b) Using SST, install the rear disc brake piston by turning it clockwise as far as possible.

SST: 09960-10010

09963-00400

- Securely install the cylinder boot to the groove of the piston.
- Do not damage the piston or cylinder boot.

(c) Using SST, slowly return the piston until the piston

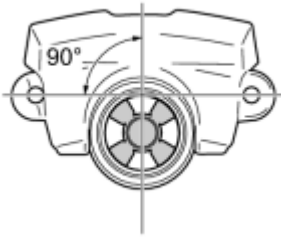

c

groove is positioned as shown in the illustration.

**HINT:**

When installing the rear disc brake cylinder assembly to the rear disc brake cylinder mounting, align the piston groove with the protrusion on the rear disc brake pad.



c

(d) Make sure that the cylinder boot is securely installed into the groove of the rear disc brake cylinder assembly and rear disc brake piston.

**Text in Illustration**

*1	Cylinder Boot
----	---------------

# INSTALLATION

## HINT:

- Use the same procedure for the LH side and RH side.
- The following procedure is for the LH side.

### 1. INSTALL REAR DISC

(a) Align the matchmarks of the disc and axle hub, and install the disc.

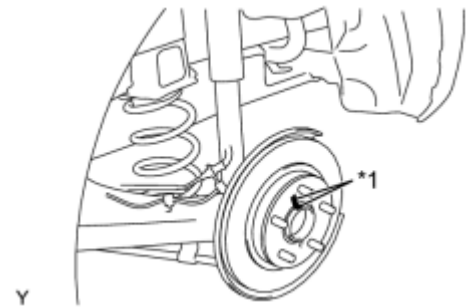

## Text in Illustration

*1	Matchmark
----	-----------

## NOTICE:

When replacing the disc with a new one, select the installation position where the rear disc has minimal runout.

### 2. INSTALL REAR DISC BRAKE CYLINDER MOUNTING

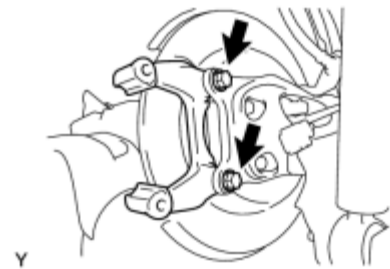

(a) Install the rear disc brake cylinder mounting to the axle beam with the 2 bolts.

Torque: **57 N·m (585 kgf·cm, 42ft·lbf)**

### 3. INSTALL REAR DISC BRAKE BUSHING DUST BOOT

(a) Apply a light layer of lithium soap base glycol grease to the entire circumference of 2 new rear disc brake bushing dust boots.

## HINT:

Apply at least 0.3 g (0.01 oz.) of lithium soap base glycol

grease to each rear disc brake bushing dust boot.

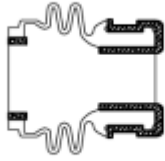

 Lithium soap base glycol grease

c

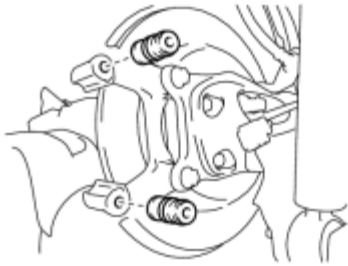

y

(b) Install the 2 rear disc brake bushing dust boots to the rear disc brake cylinder mounting.

#### 4. INSTALL REAR DISC BRAKE PAD GUIDE PIN



 Lithium soap base glycol grease

c

(a) Apply a light layer of lithium soap base glycol grease to the sliding and sealing surfaces of the 2 rear disc brake pad guide pins.

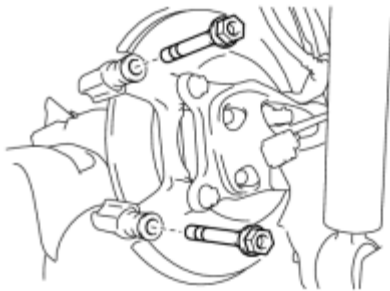

(b) Install the 2 rear disc brake pad guide pins to the rear disc brake cylinder mounting.

#### 5. INSTALL REAR DISC BRAKE PAD SUPPORT PLATE



(a) Install the 2 rear disc brake pad support plates to the rear disc brake cylinder mounting.

NOTICE:

Be sure to install each rear disc brake pad support plate in the correct position and direction.

c

## 6. INSTALL REAR DISC BRAKE ANTI-SQUEAL SHIM

Inner Pad:



Outer Pad:



 Disc brake grease

(a) Apply disc brake grease to the back plate of the rear disc brake pads.

(b) Install the rear No. 1 disc brake anti-squeal shim and rear No. 2 disc brake anti-squeal shim to each rear disc brake pad.

## Text in Illustration

*1	Rear No. 1 Disc Brake Anti-squeal Shim
----	--

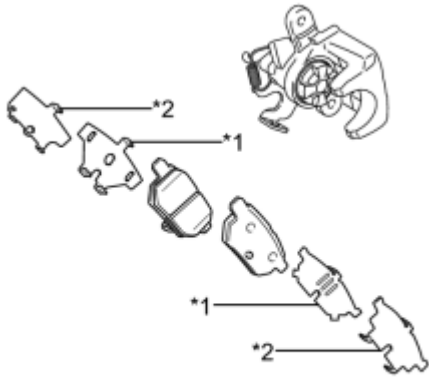

**\*2 Rear No. 2 Disc Brake Anti-squeal Shim**

- When replacing worn pads, the anti-squeal shims must be replaced together with the pads.
- Apply disc brake grease to the area that contacts the anti-squeal shim.
- Disc brake grease may seep out slightly from the areas where the anti-squeal shims are installed.
- Make sure that disc brake grease is not applied onto the lining surface.

c

**7. INSTALL REAR DISC BRAKE PAD**

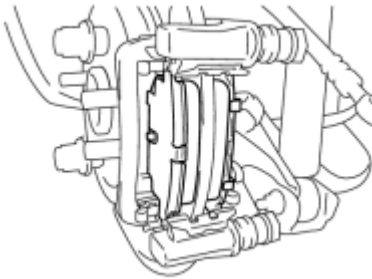

(a) Install the 2 rear disc brake pads to the rear disc brake cylinder mounting.

**NOTICE:**

There should be no oil or grease on the friction surfaces of the disc brake pads or the rear disc.

y

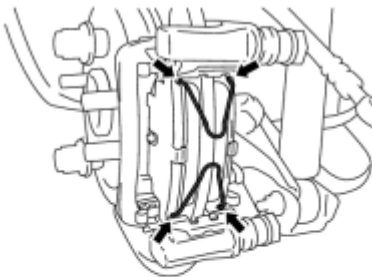

(b) Install the 2 anti-squeal springs to the rear disc brake pads.

- When replacing the rear disc brake pads with new ones, make sure to replace the anti-squeal springs at the same time.
- Be sure to install the anti-squeal springs into the rear disc brake pad installation holes as far as they will go.



c

**8. INSTALL REAR DISC BRAKE CYLINDER ASSEMBLY**

(a) To compensate for pad wear when reusing the pad, use SST to turn the piston to the position where the protrusion on the pad lines up properly with the piston groove.

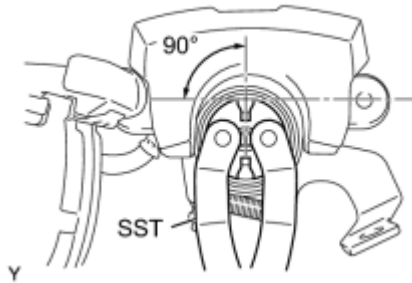

Retract	Extend
Clockwise	Counterclockwise

SST: 09960-10010

09963-00400

NOTICE:

Place the disc between the 2 brake pads and determine the piston return value.

(b) Hold the rear disc brake cylinder pad guide pin, and install the rear disc brake cylinder assembly to the rear disc brake cylinder mounting with the 2 bolts.

### Text in Illustration

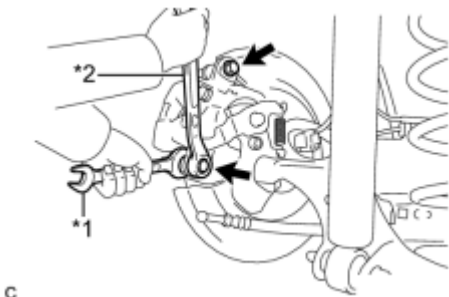

*1	Hold
*2	Turn

Torque: **34 N·m (350 kgf·cm, 25ft·lbf)**

- Install the rear disc brake cylinder assembly while holding both of the rear disc brake pads because the anti-squeal springs may fall off the rear disc brake pads.
- Be sure that the anti-squeal springs are installed to the rear disc brake pads.

## 9. CONNECT REAR FLEXIBLE HOSE

(a) Connect the rear flexible hose to the rear disc brake cylinder assembly with a new union bolt and a new gasket.

Torque: **33 N·m (340 kgf·cm, 25ft·lbf)**

HINT:

Install the flexible hose lock securely into the lock hole in

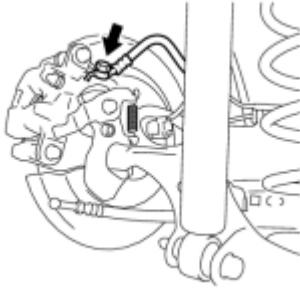

the disc brake cylinder.

c

## 10. CONNECT NO. 3 PARKING BRAKE CABLE ASSEMBLY

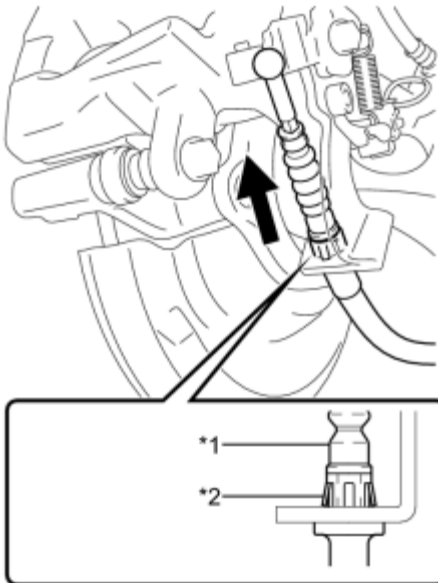

(a) Install the No. 3 parking brake cable assembly to the rear disc brake cylinder assembly.

### Text in Illustration

*1	No. 3 Parking Brake Cable Assembly
*2	Clip

HINT:

Be sure to engage the No. 3 parking brake cable assembly clip onto the rear disc brake cylinder assembly as shown in the illustration.

c

(b) Connect the No. 3 parking brake cable assembly to the rear disc brake cylinder assembly.



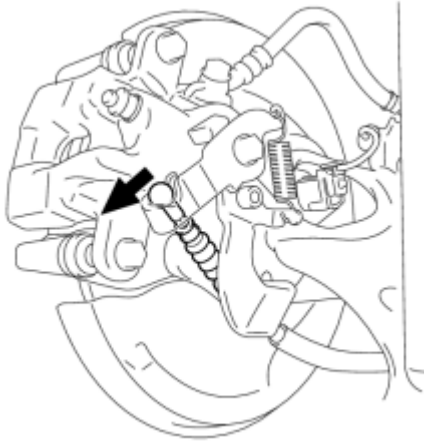

c

11. BLEED BRAKE LINE [INFO](#)

12. PERFORM INITIALIZATION AND CALIBRATION OF LINEAR SOLENOID VALVE

HINT:

If the brake control has been disabled, make sure to perform initialization and calibration of the linear solenoid valve [INFO](#).

13. ADJUST PARKING BRAKE

HINT: [INFO](#)

14. INSTALL LOWER INSTRUMENT PANEL FINISH PANEL ASSEMBLY [INFO](#)

15. INSTALL COWL SIDE TRIM SUB-ASSEMBLY LH [INFO](#)

16. INSTALL FRONT DOOR SCUFF PLATE LH [INFO](#)

17. INSTALL REAR WHEEL

Torque: **103 N·m (1050 kgf·cm, 76ft·lbf)**