

L37(A), L38(B), L39(C), L40(D), L41(E), L42(F), L45(G)
 Navigation Receiver Assembly
 L40(D), L41(E), L45(G)
 Radio Receiver Assembly

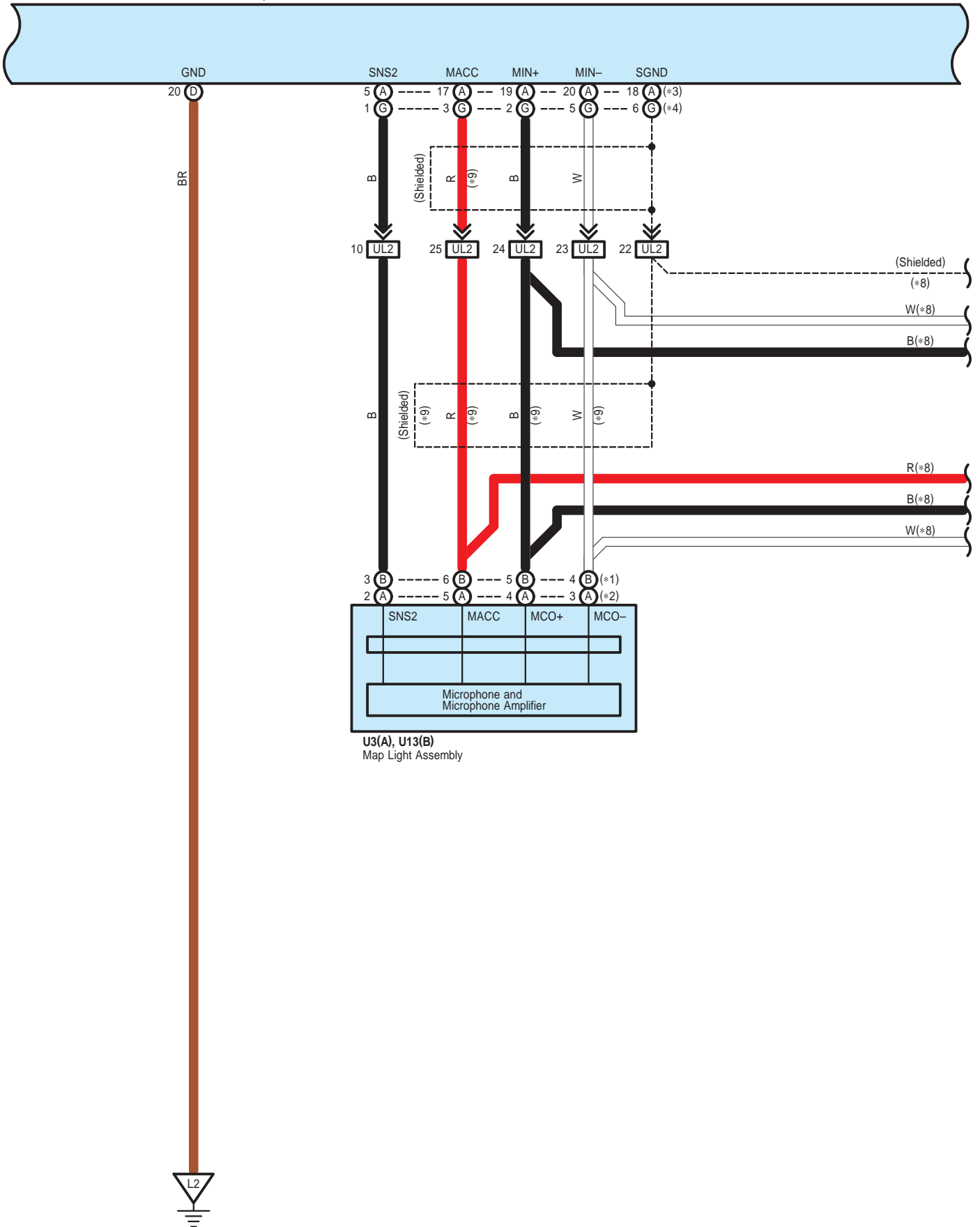

U3(A), U13(B)
 Map Light Assembly

L37(A), L38(B), L39(C), L40(D), L41(E), L42(F), L45(G)
 Navigation Receiver Assembly
 L40(D), L41(E), L45(G)
 Radio Receiver Assembly

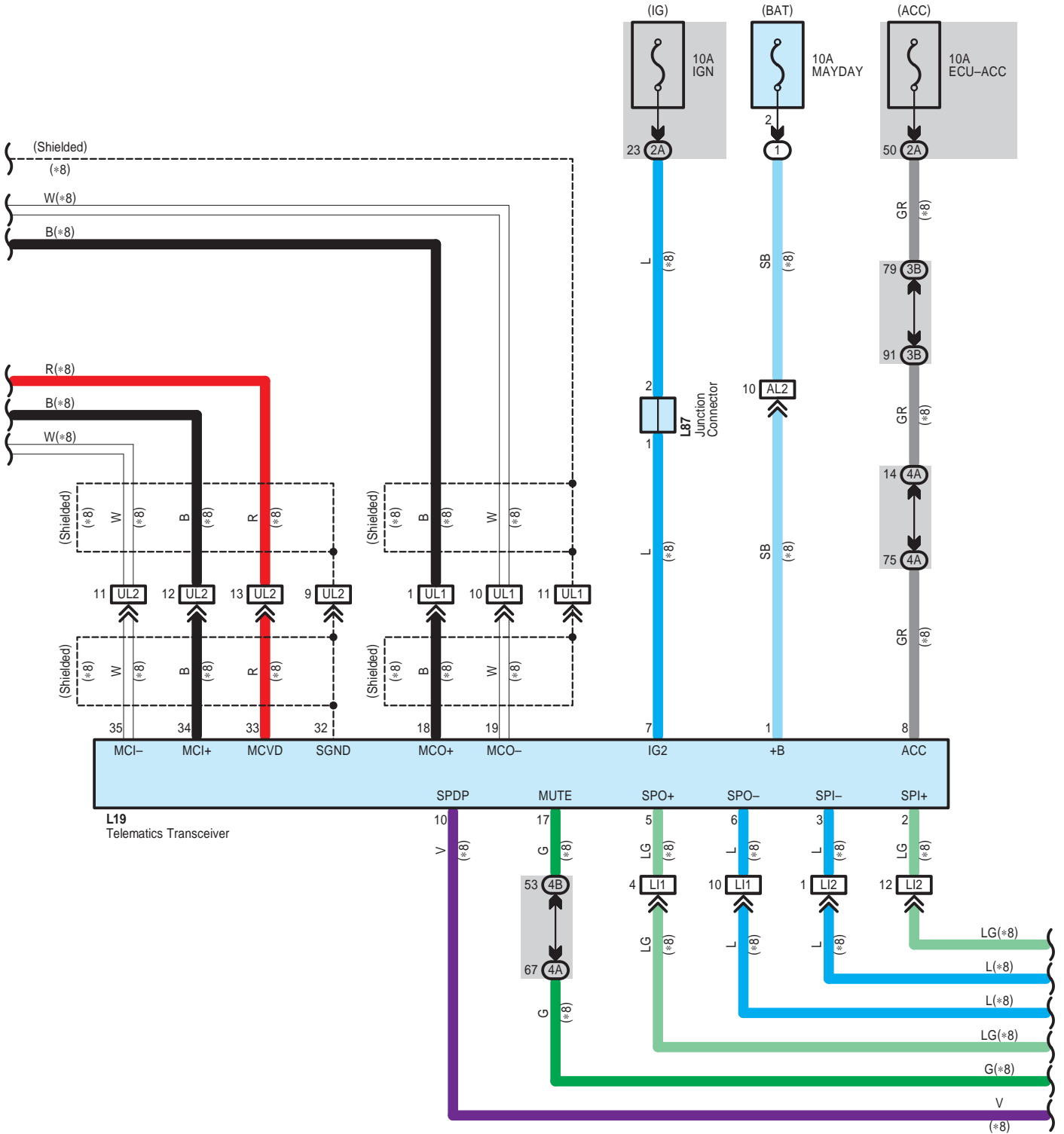

L37(A), L38(B), L39(C), L40(D), L41(E), L42(F), L45(G)
 Navigation Receiver Assembly
 L40(D), L41(E), L45(G)
 Radio Receiver Assembly

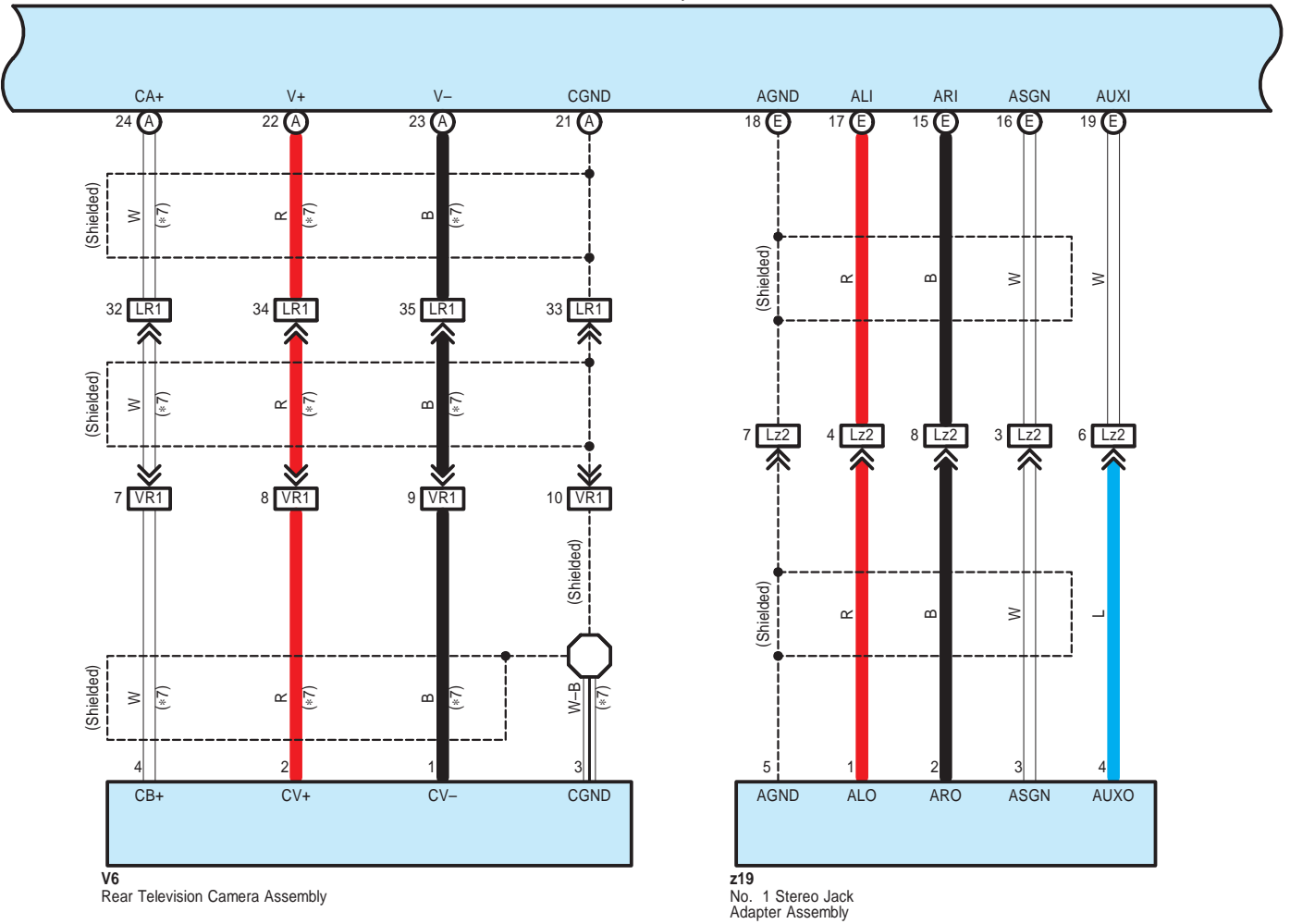

* 7 : w/ Rear View Monitor
 * 8 : w/ Safety Connect System



L37(A), L38(B), L39(C), L40(D), L41(E), L42(F), L45(G)
 Navigation Receiver Assembly
 L40(D), L41(E), L45(G)
 Radio Receiver Assembly

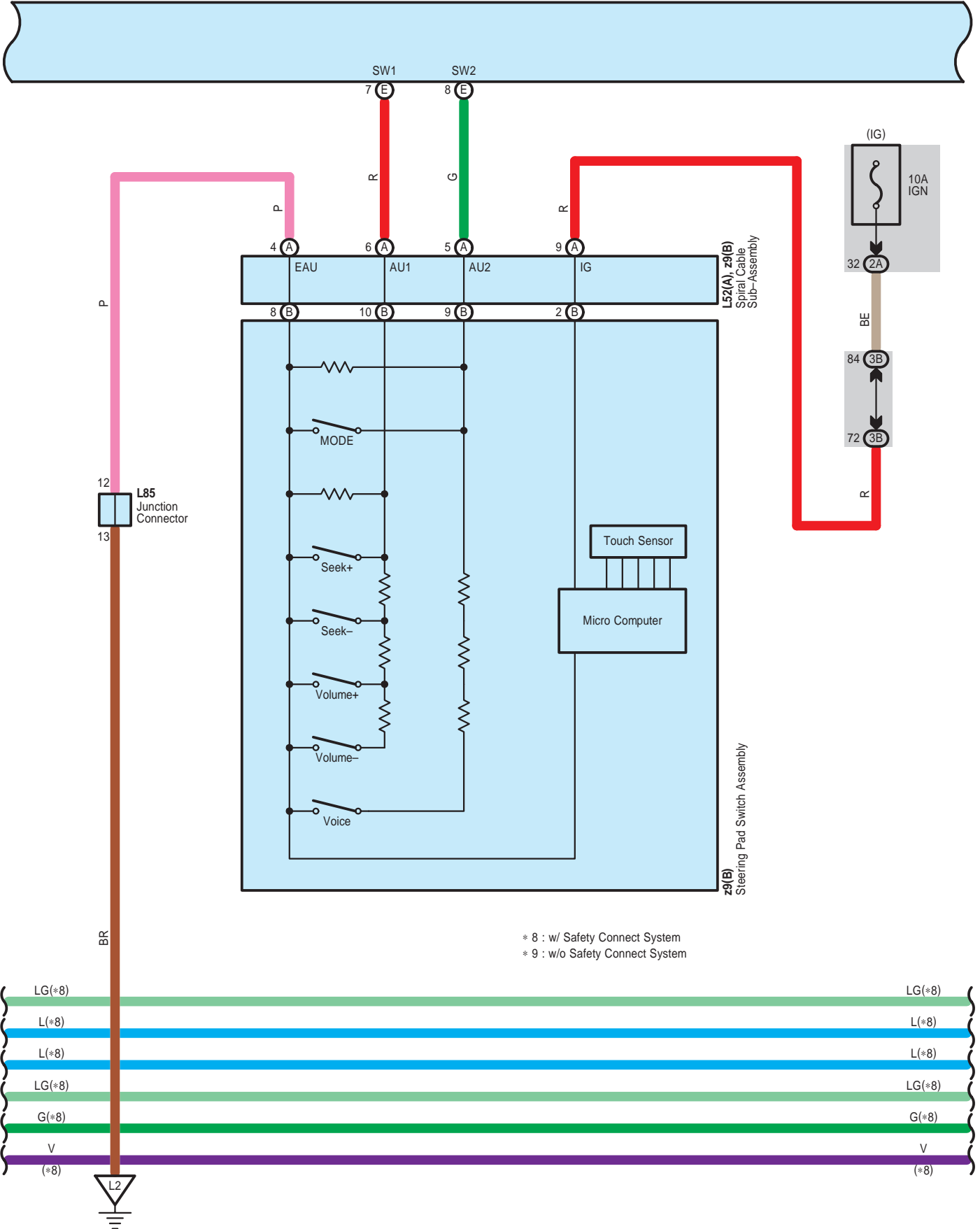

* 8 : w/ Safety Connect System
 * 9 : w/o Safety Connect System

L37(A), L38(B), L39(C), L40(D), L41(E), L42(F), L45(G)
 Navigation Receiver Assembly
 L40(D), L41(E), L45(G)
 Radio Receiver Assembly

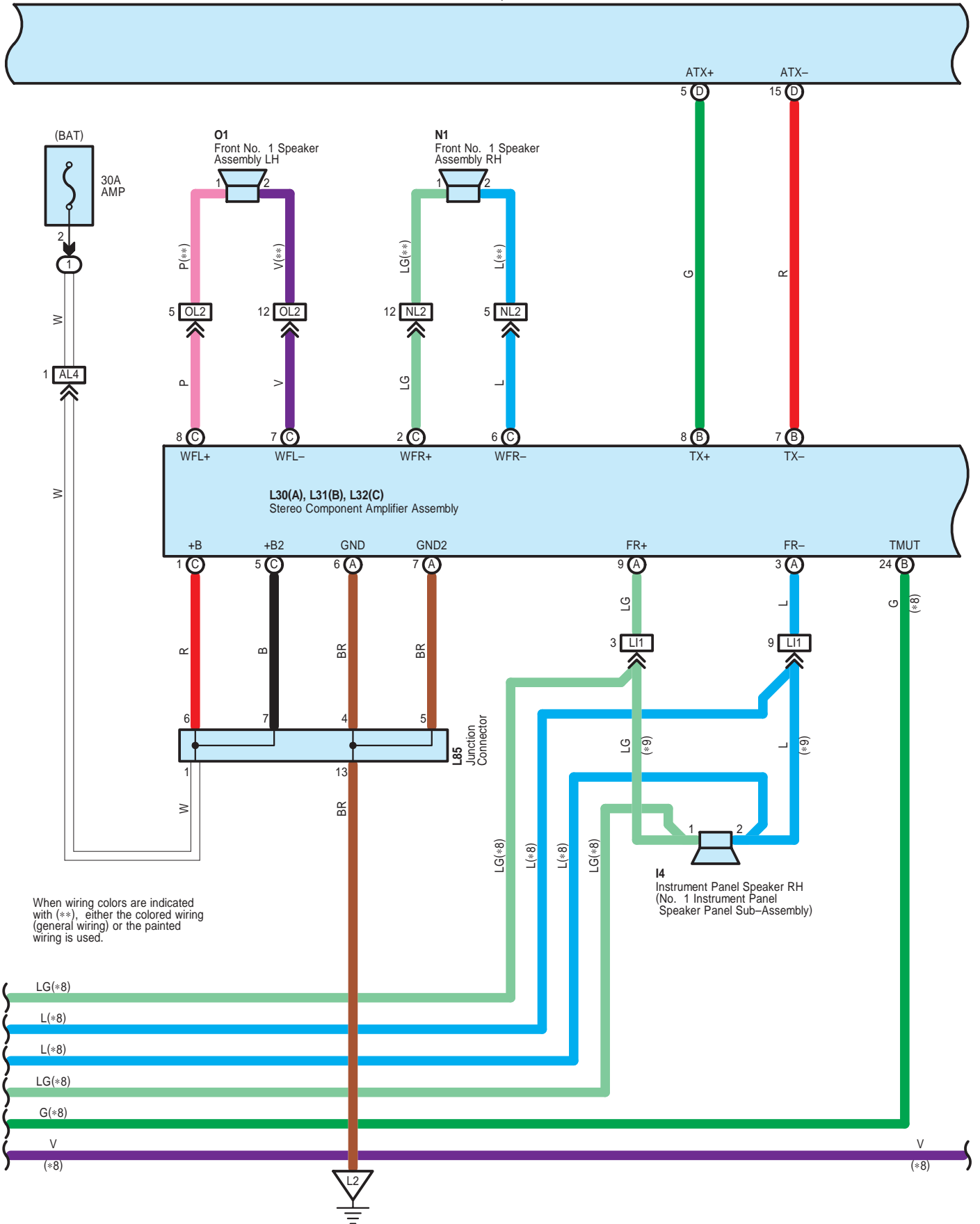

When wiring colors are indicated with (**), either the colored wiring (general wiring) or the painted wiring is used.

L37(A), L38(B), L39(C), L40(D), L41(E), L42(F), L45(G)
 Navigation Receiver Assembly
 L40(D), L41(E), L45(G)
 Radio Receiver Assembly

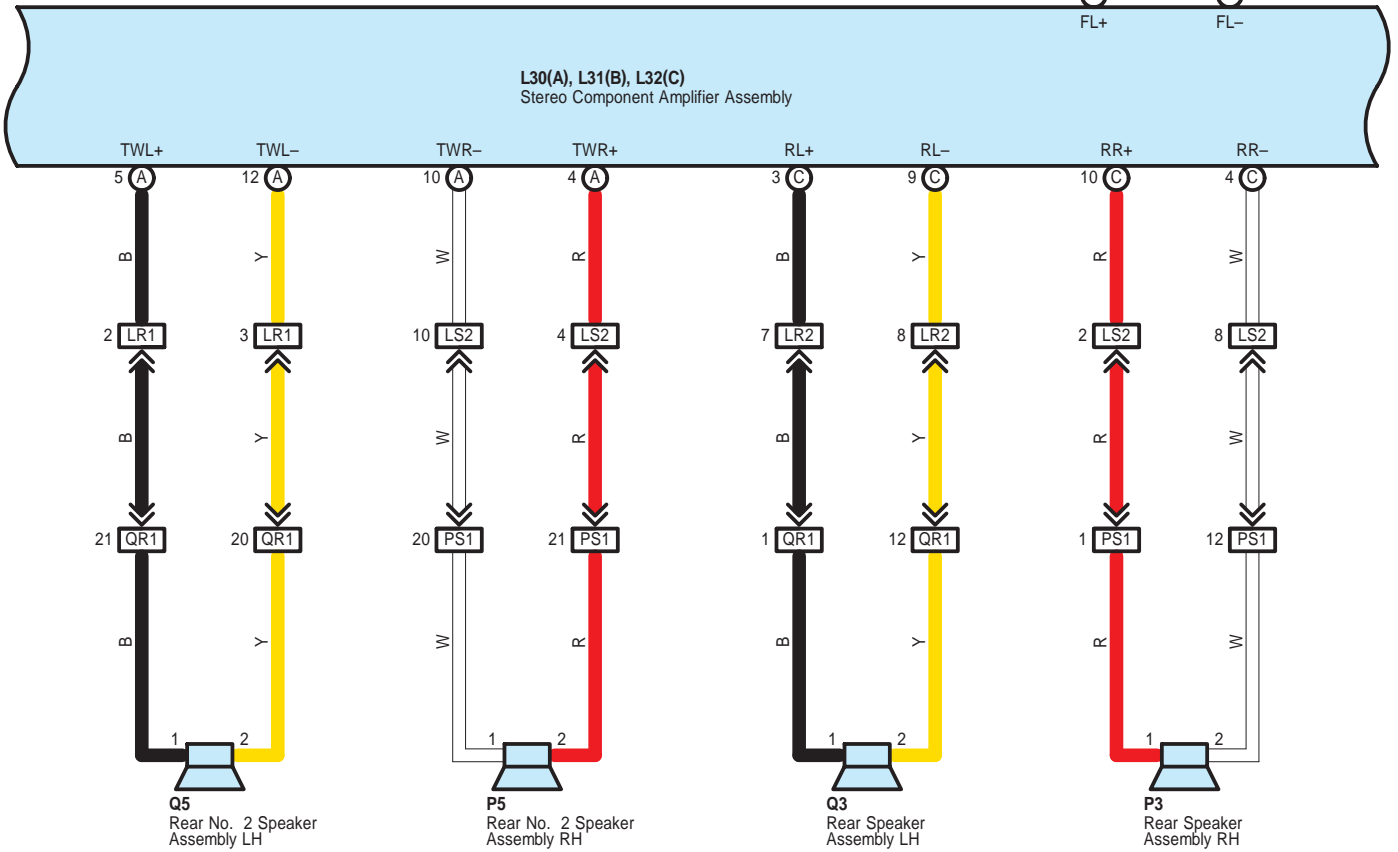
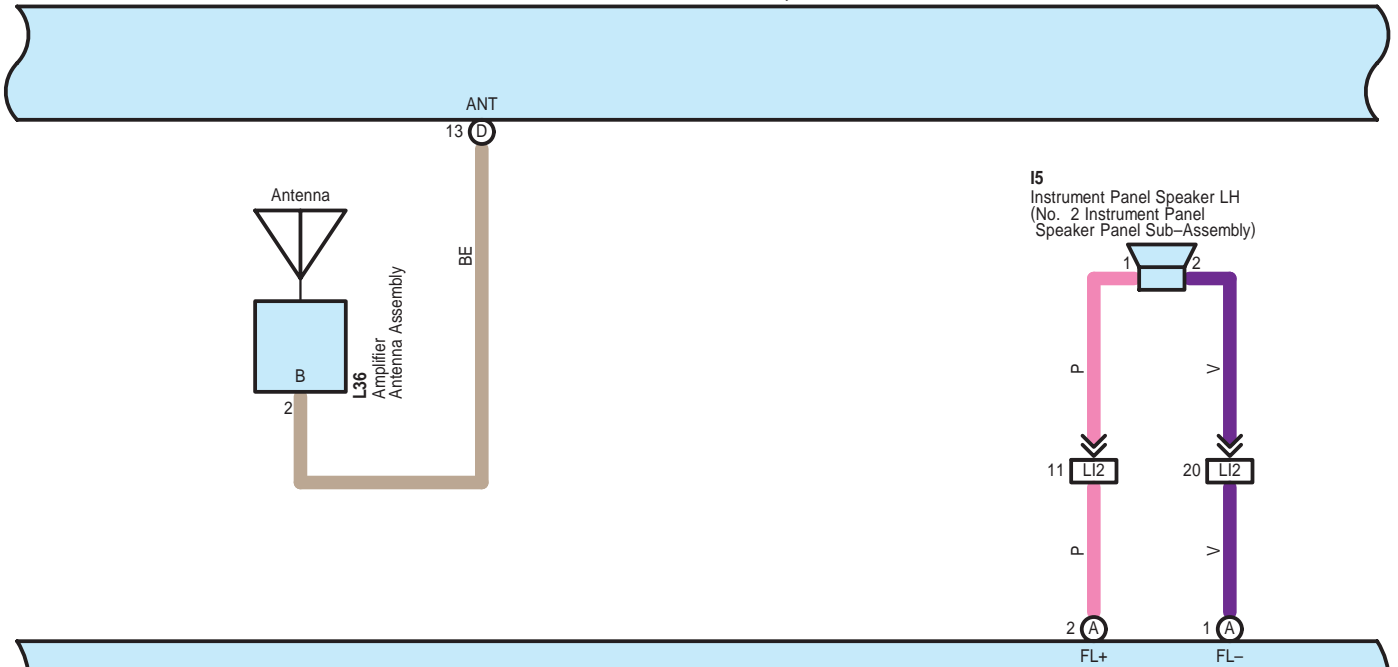

L37(A), L38(B), L39(C), L40(D), L41(E), L42(F), L45(G)
 Navigation Receiver Assembly
 L40(D), L41(E), L45(G)
 Radio Receiver Assembly

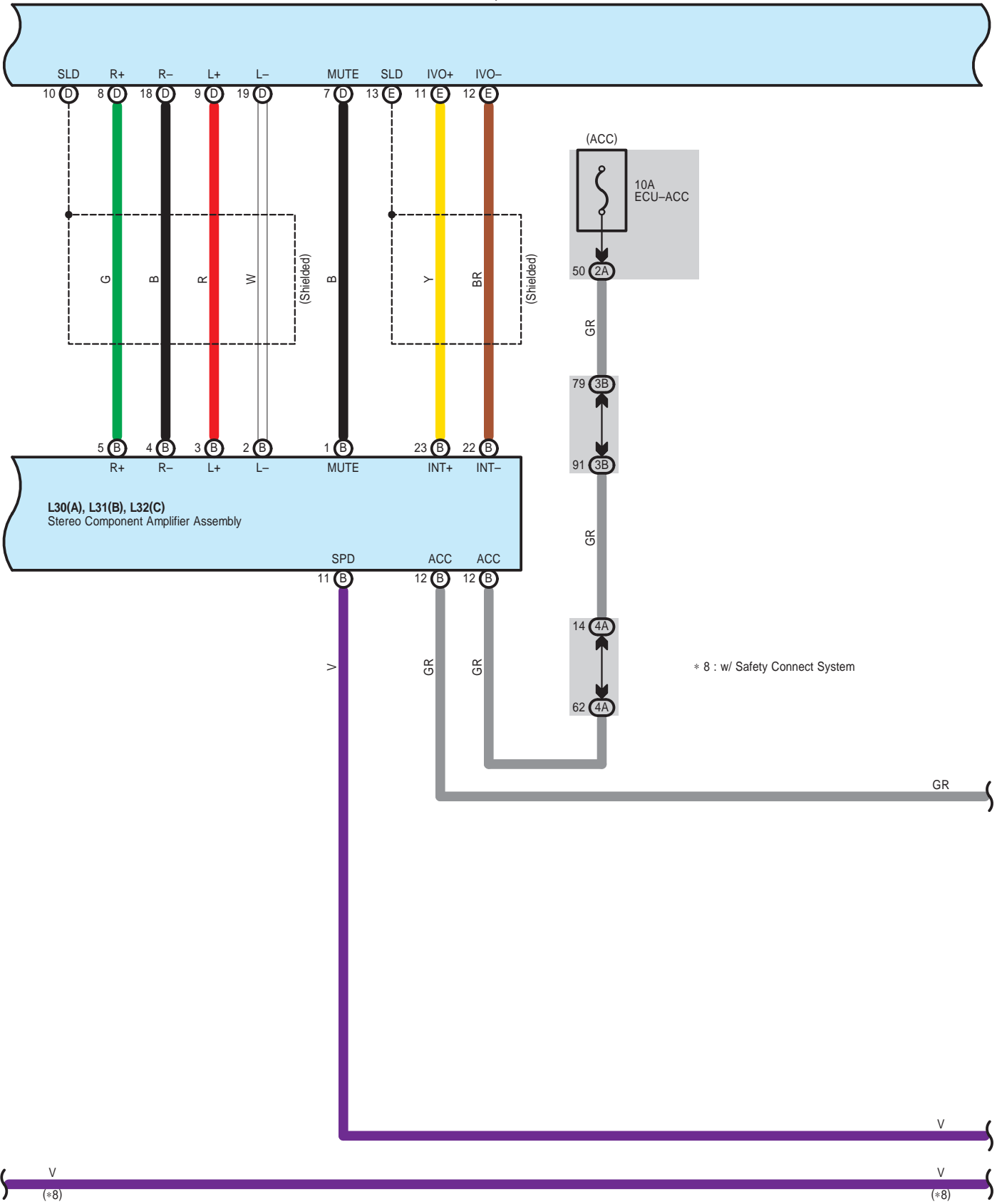

L37(A), L38(B), L39(C), L40(D), L41(E), L42(F), L45(G)
 Navigation Receiver Assembly
 L40(D), L41(E), L45(G)
 Radio Receiver Assembly

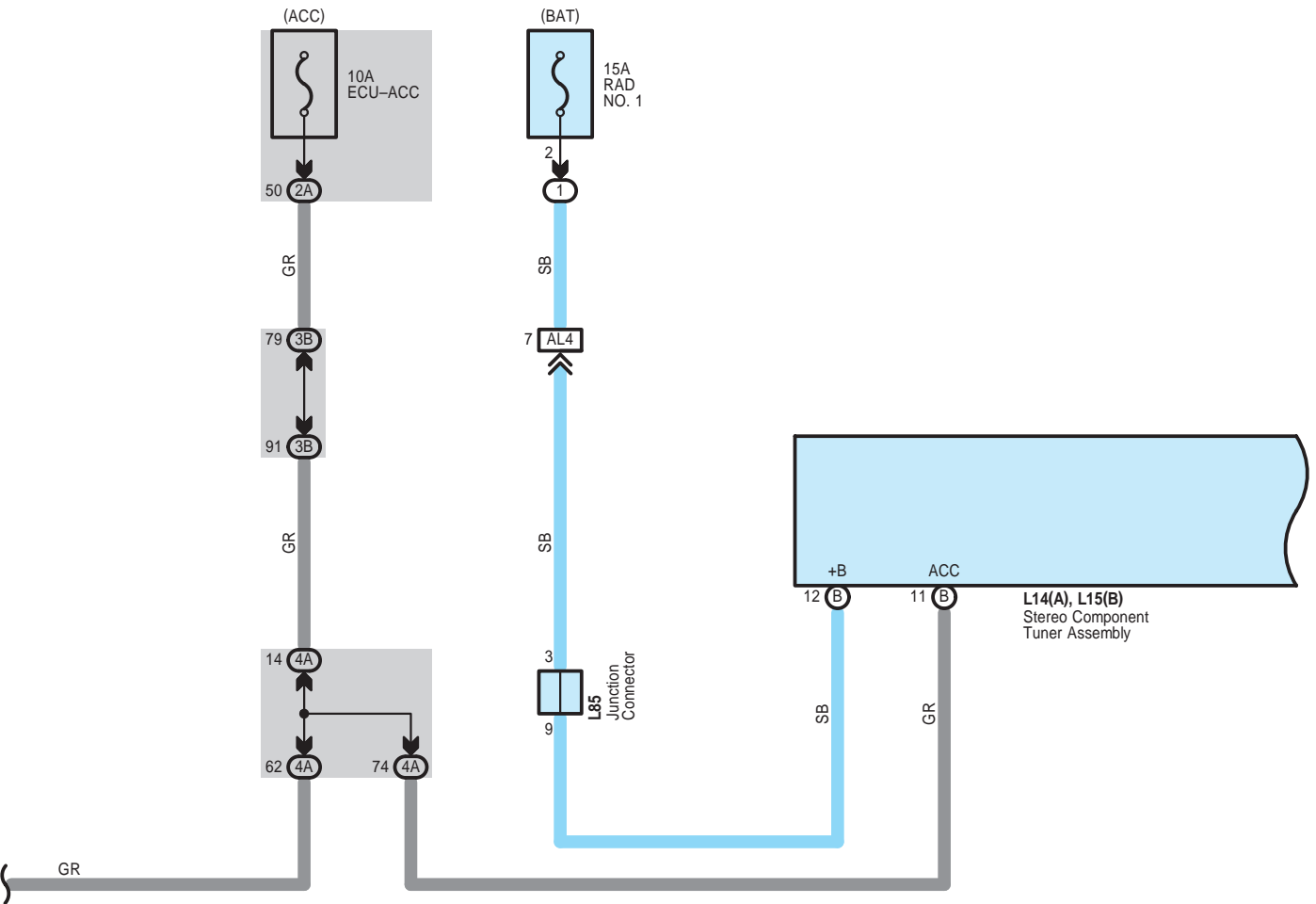
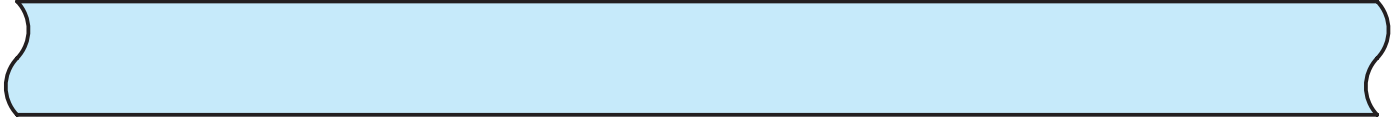

L37(A), L38(B), L39(C), L40(D), L41(E), L42(F), L45(G)
 Navigation Receiver Assembly
 L40(D), L41(E), L45(G)
 Radio Receiver Assembly

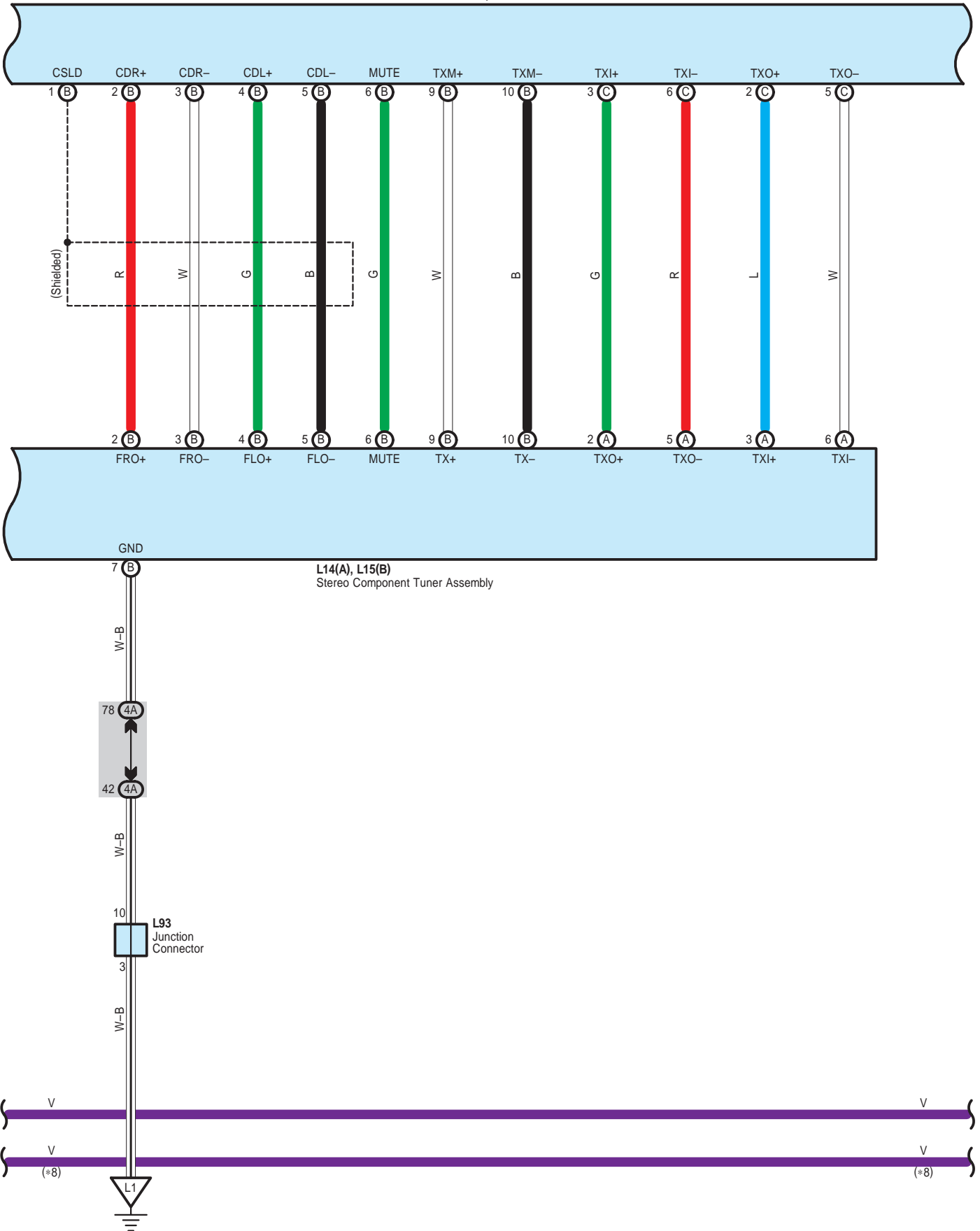

L37(A), L38(B), L39(C), L40(D), L41(E), L42(F), L45(G)
 Navigation Receiver Assembly
 L40(D), L41(E), L45(G)
 Radio Receiver Assembly

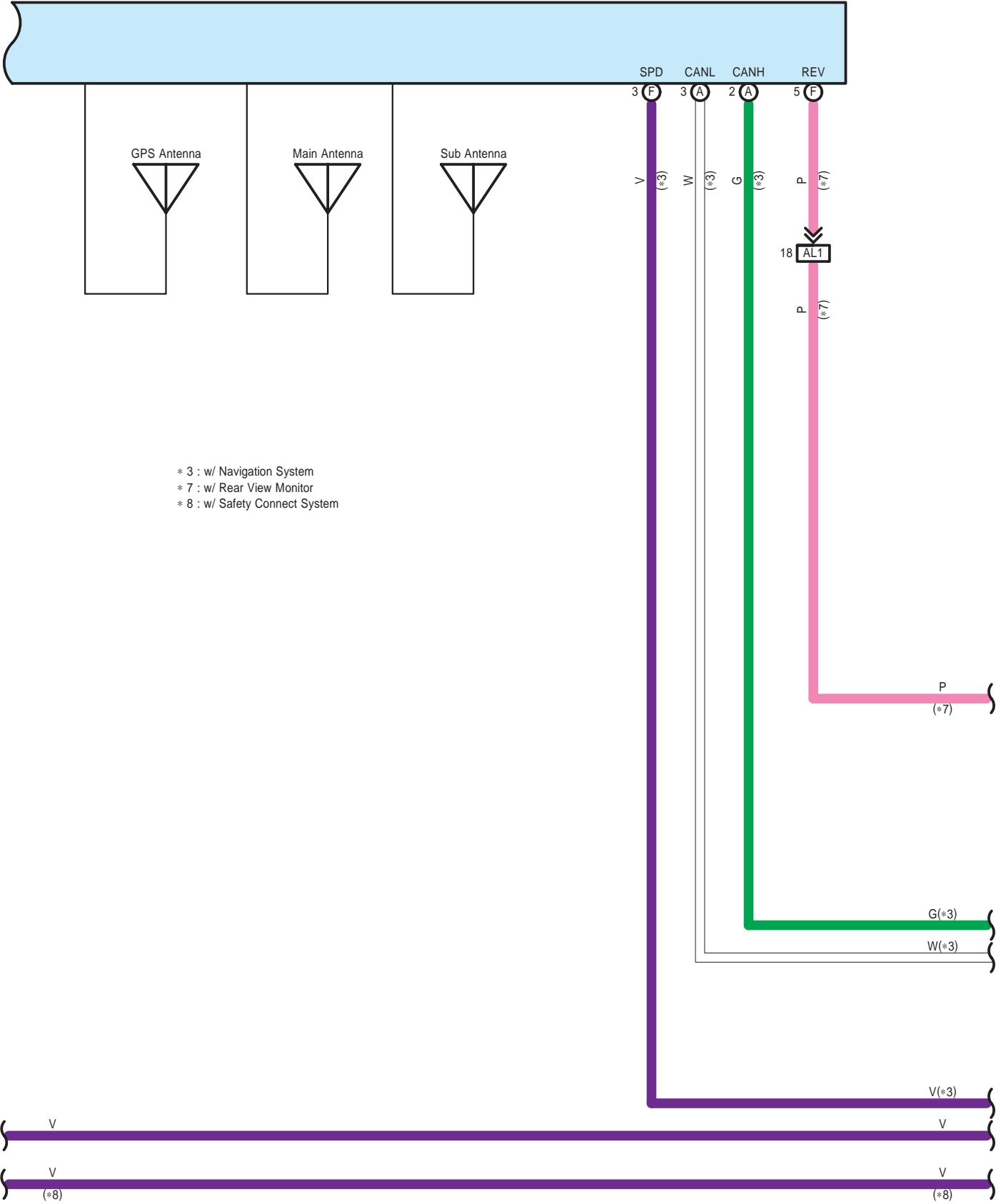

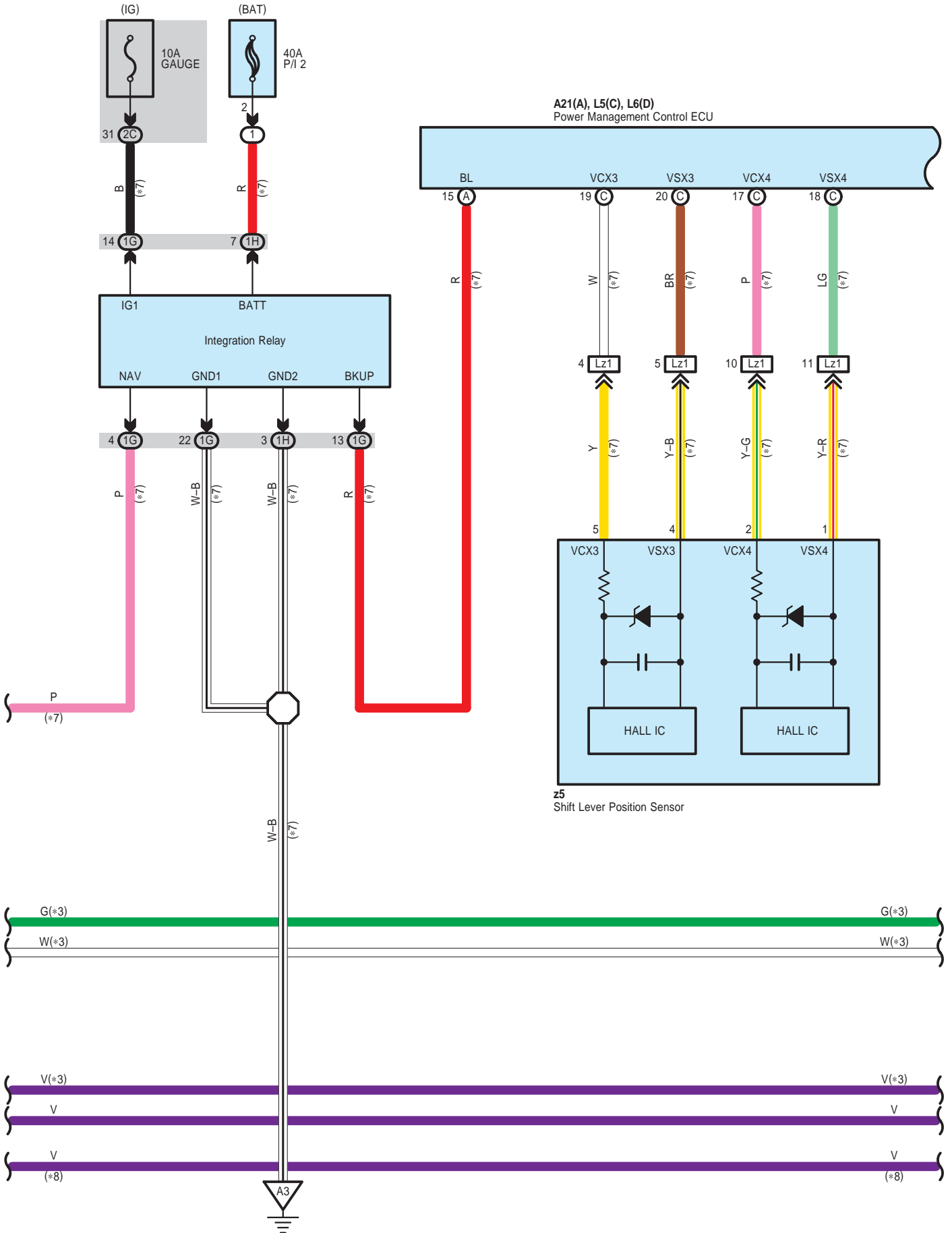

- * 3 : w/ Navigation System
- * 7 : w/ Rear View Monitor
- * 8 : w/ Safety Connect System

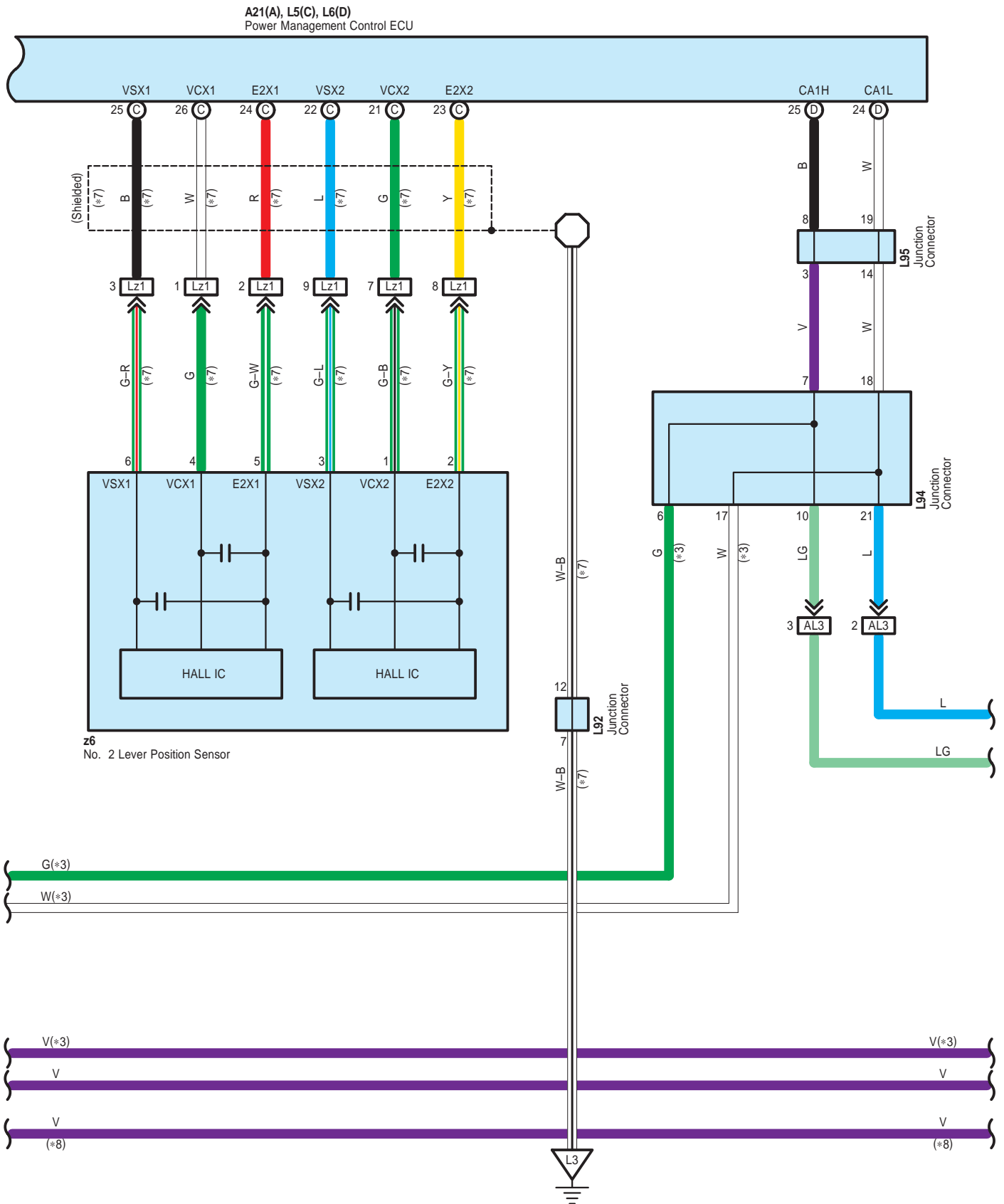

A58
Skid Control ECU with Actuator Assembly

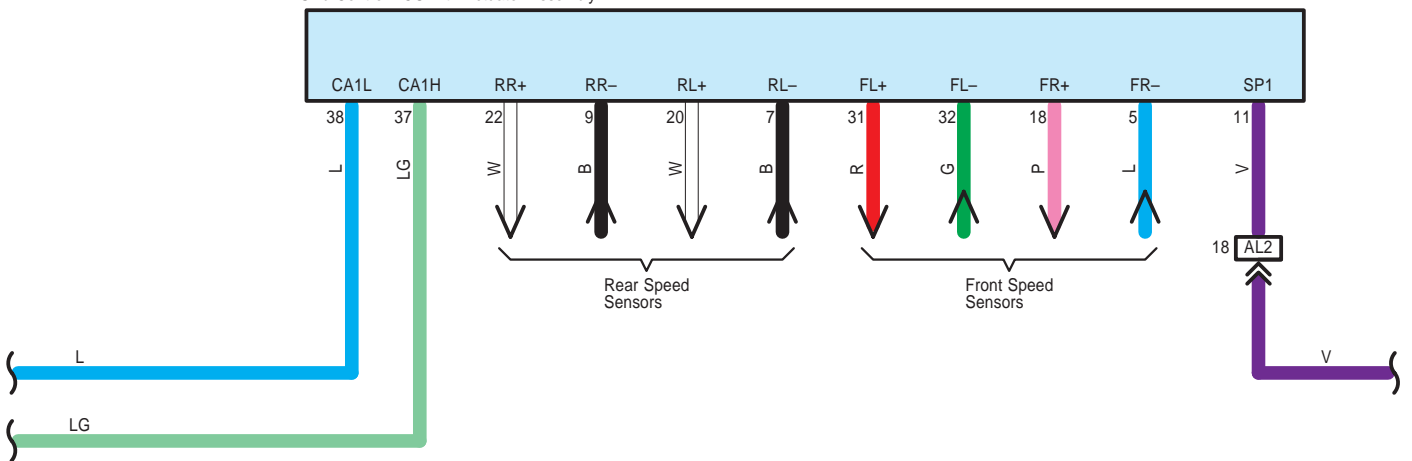

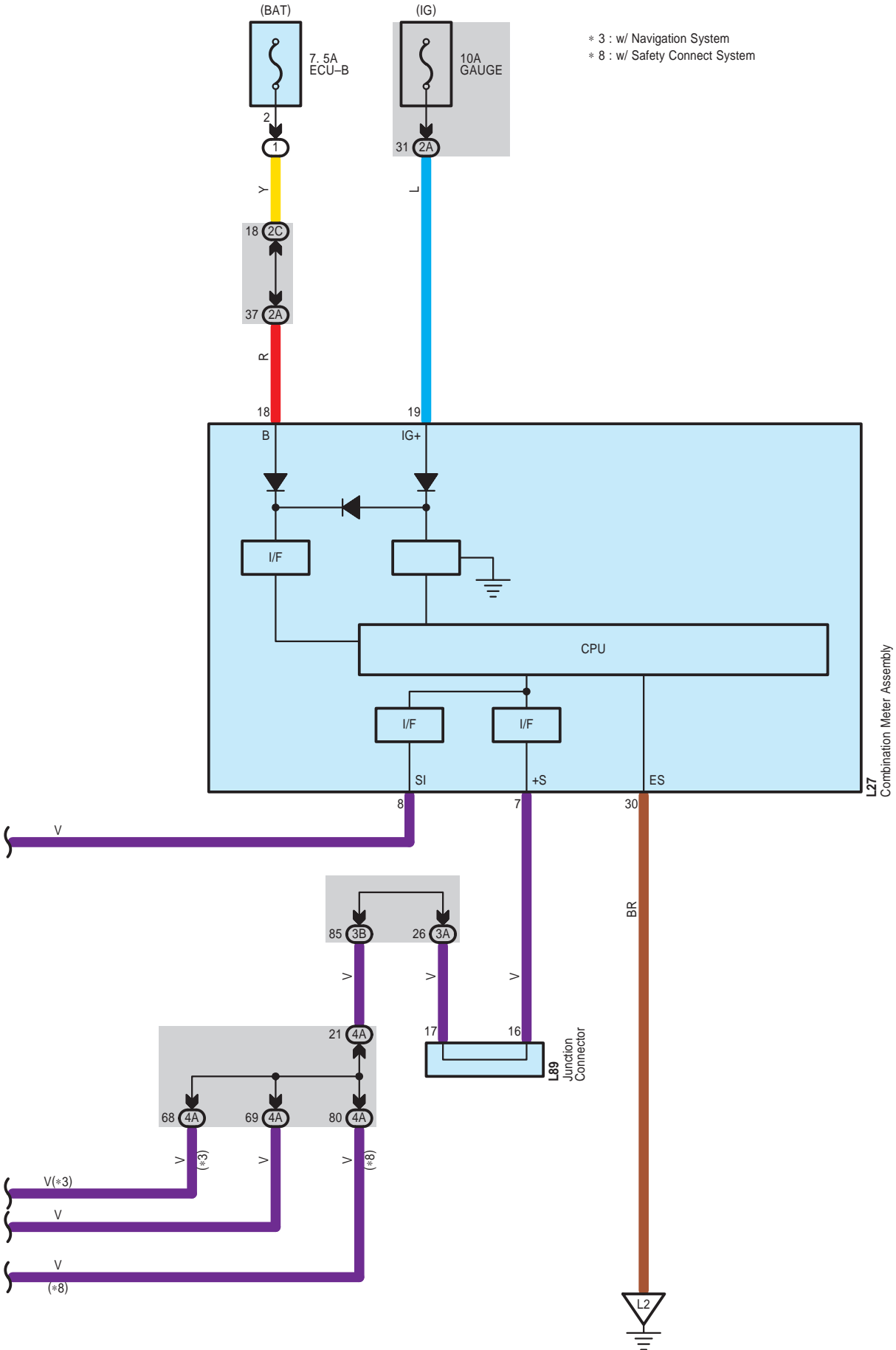

A 21
Gray

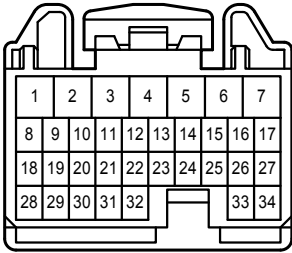

A 25
White



A 58
Gray

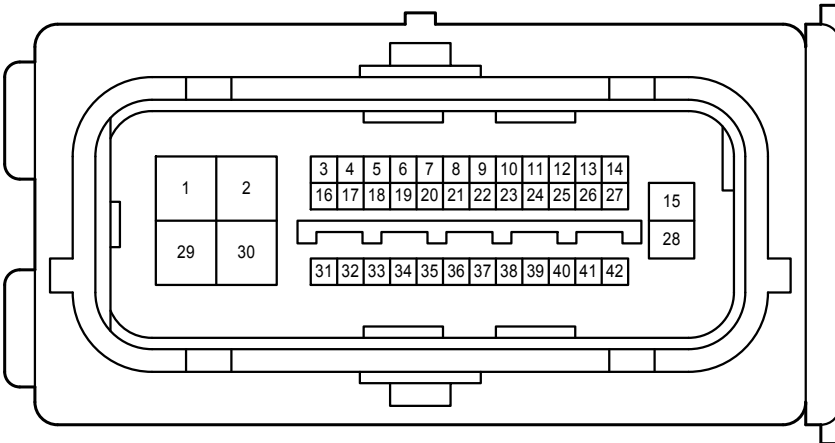

I 4
White

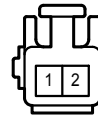

I 5
White

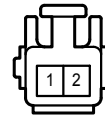

L 5
Gray

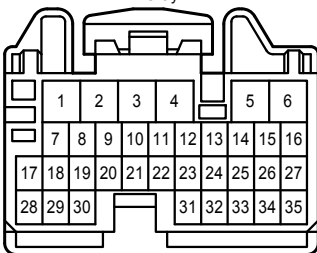

L 6
Gray

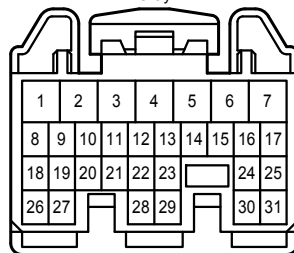

L 14
Blue

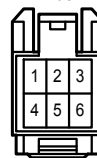

L 15
White

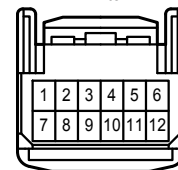

L 19
White

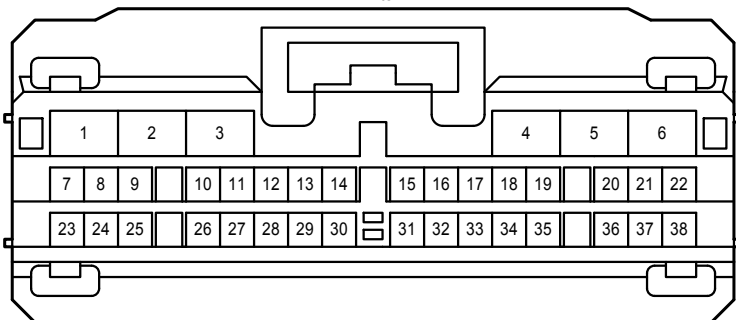

L 27
White

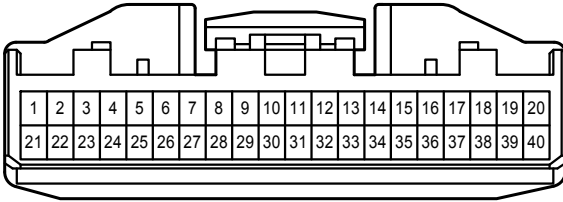

L 30
White

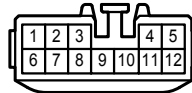

L 31
White

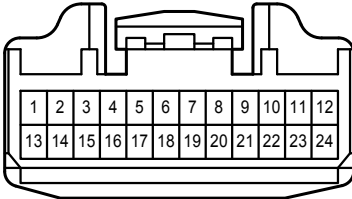

L 32
Blue

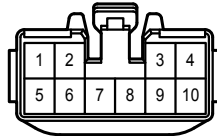

L 36
White



L 37
White

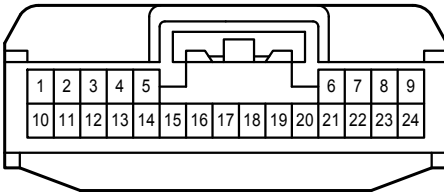

L 38
Black

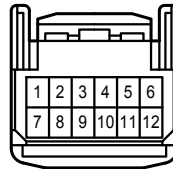

L 39
Blue

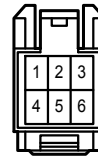

L 40
White

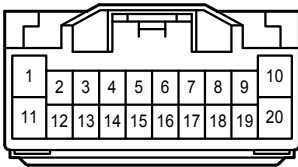

L 41
White

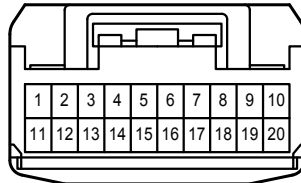

L 42
Gray

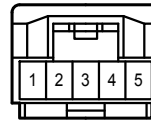

L 45
White

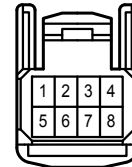

L 52
Black

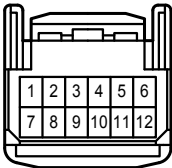

L 85
White

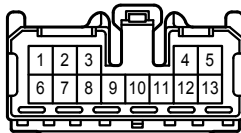

L 87
Black

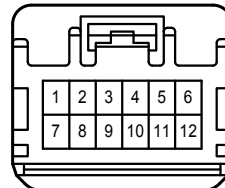

L 89
Black

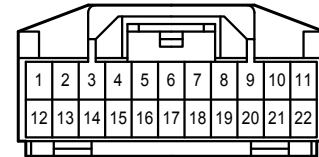

L 92
White

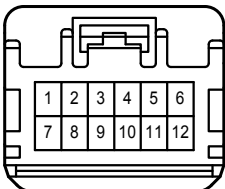

L 93
White

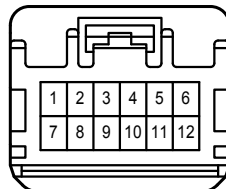

L 94
White

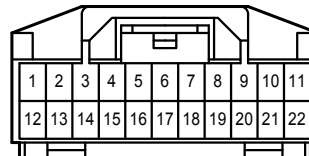

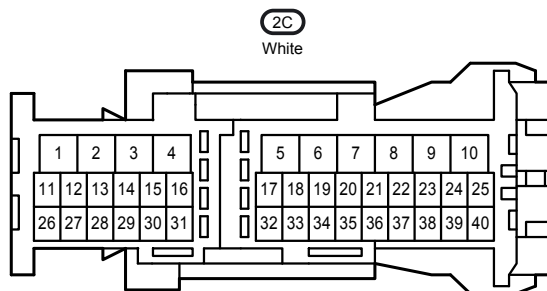
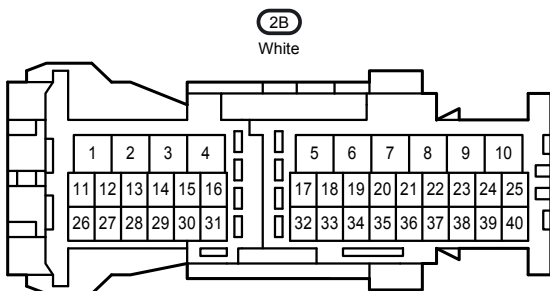
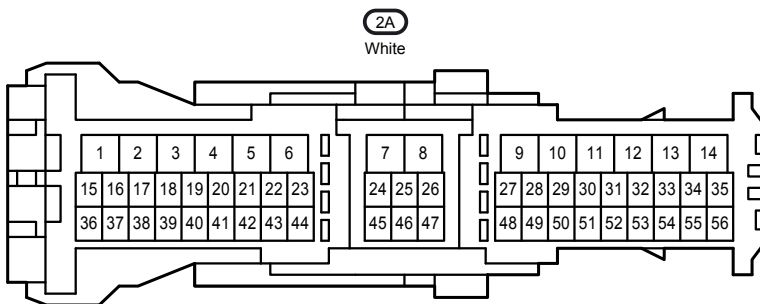
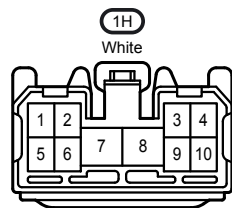
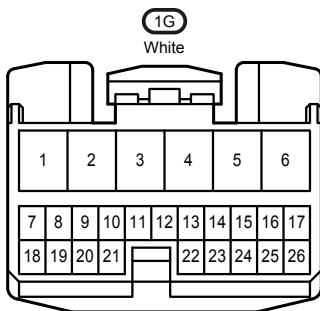
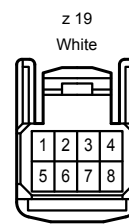
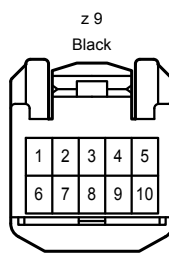
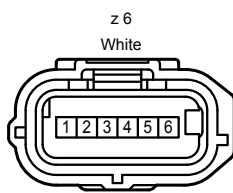
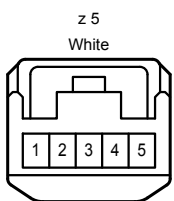
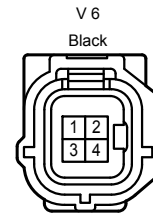
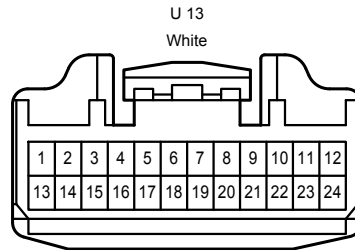
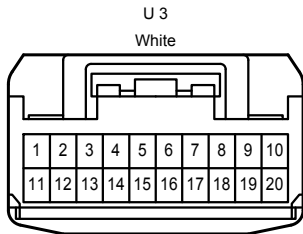
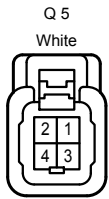
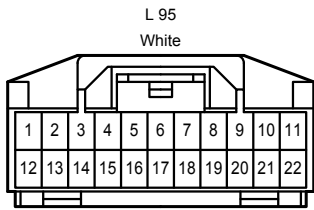

3A
White

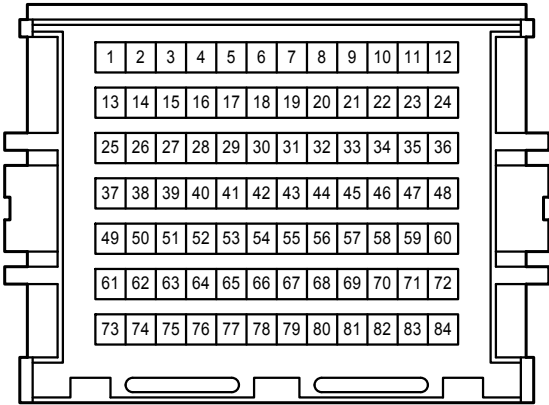

3B
White

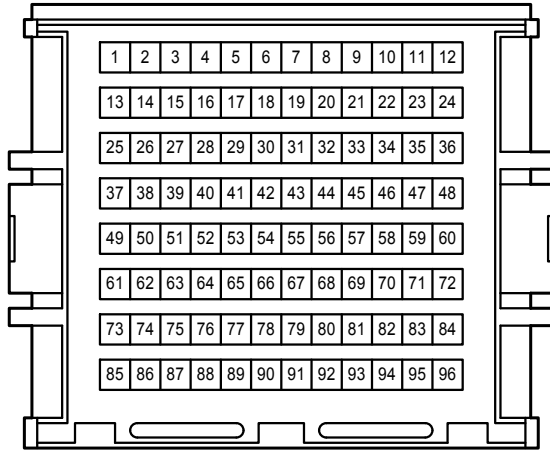

4A
White

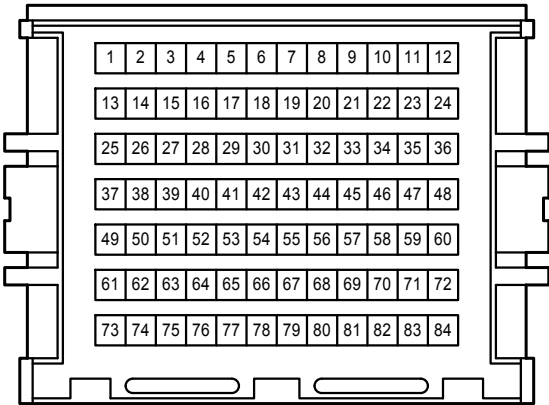

4B
White

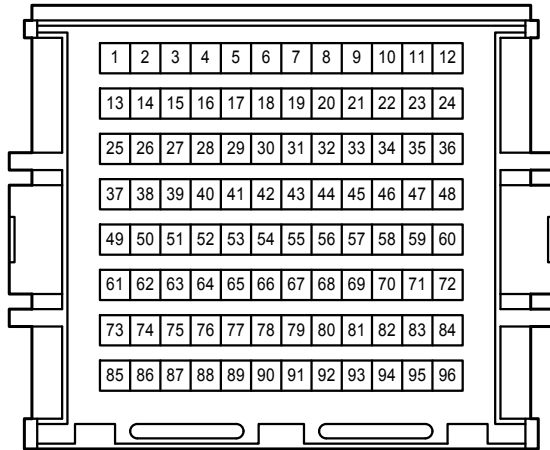

AL1
Blue

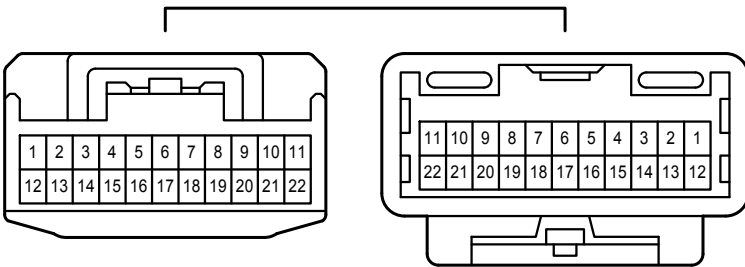

AL2
Gray

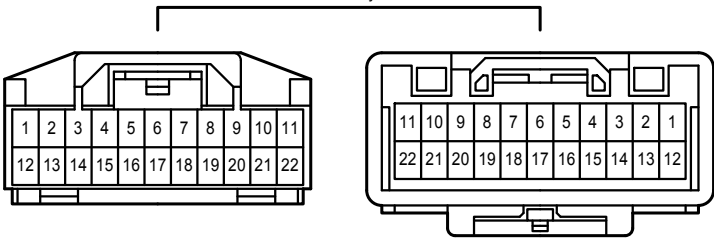

AL3
White

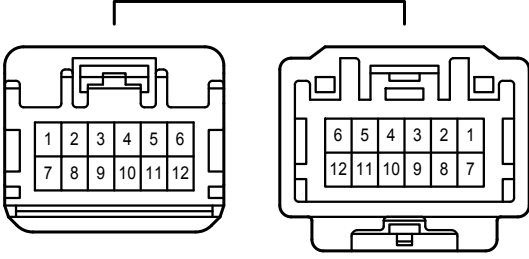

AL4
Black

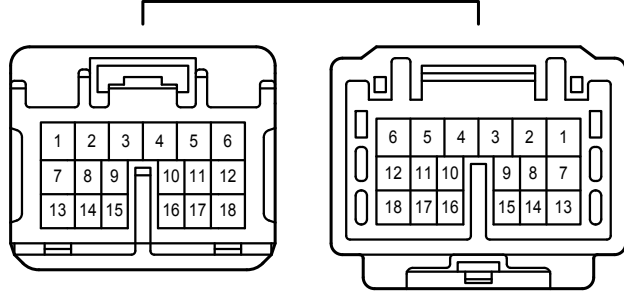

L11
Black

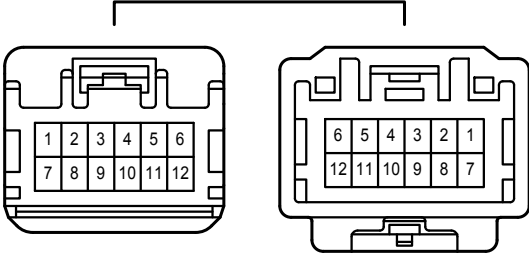

L12
White

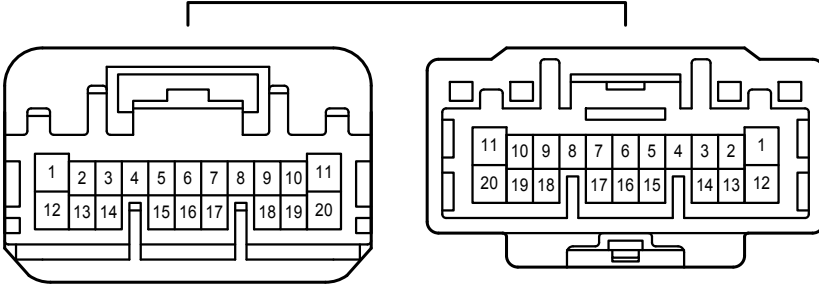

LR1
White

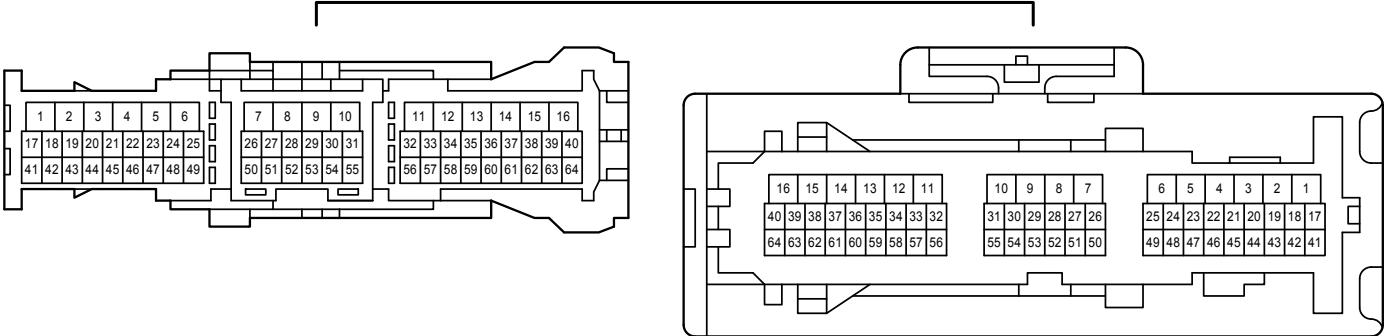

LR2
Black

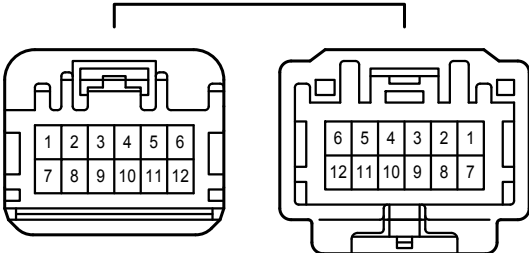

LS2
Black

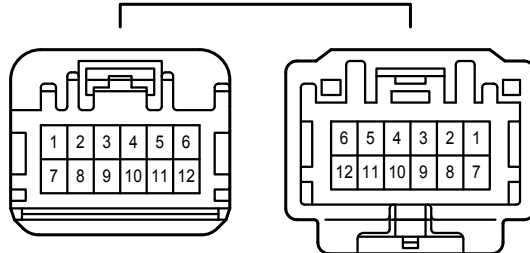

Lz1
White

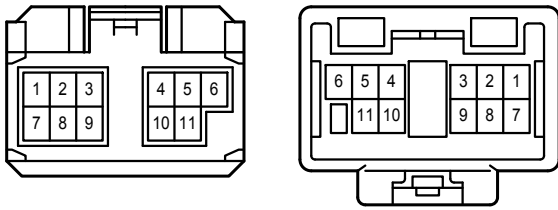

Lz2
White

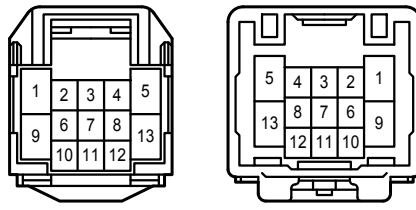

NL2
White

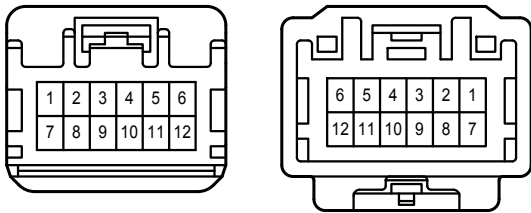

OL2
White

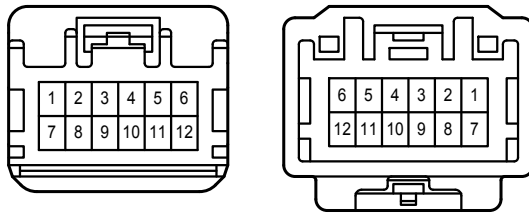

PS1
White

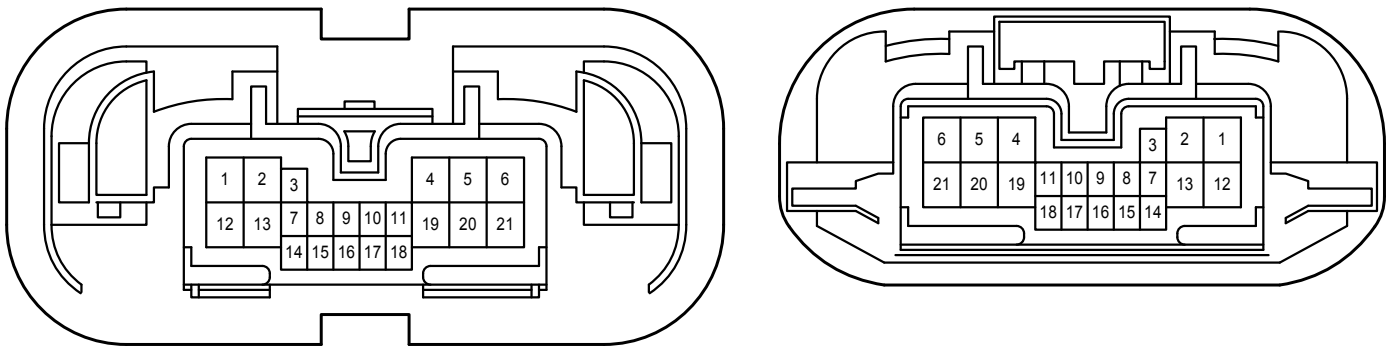

QR1
White

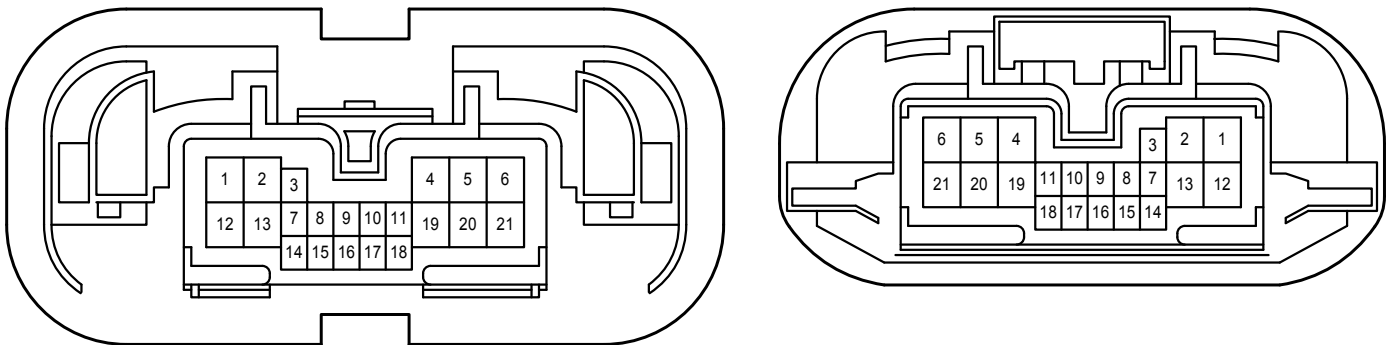

UL1
Gray

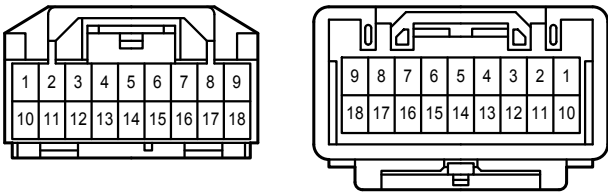

UL2
White

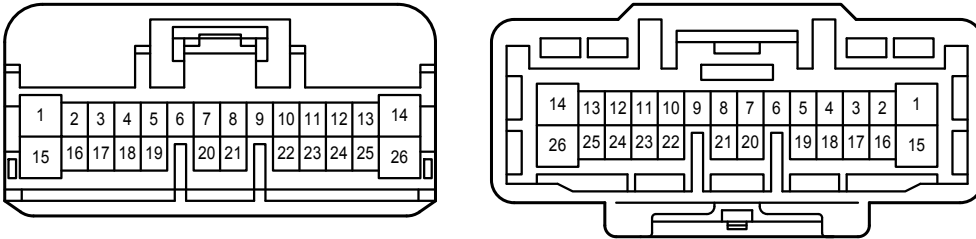

VR1
White

