

# COMPONENTS

## ILLUSTRATION

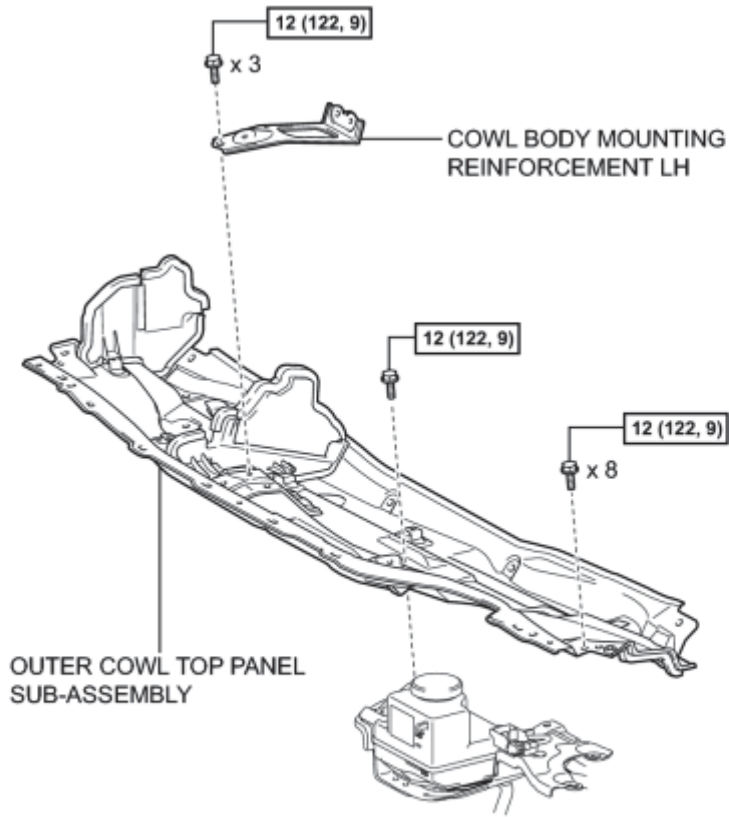

**N\*m (kgf\*cm, ft.\*lbf)**: Specified torque

P

## ILLUSTRATION

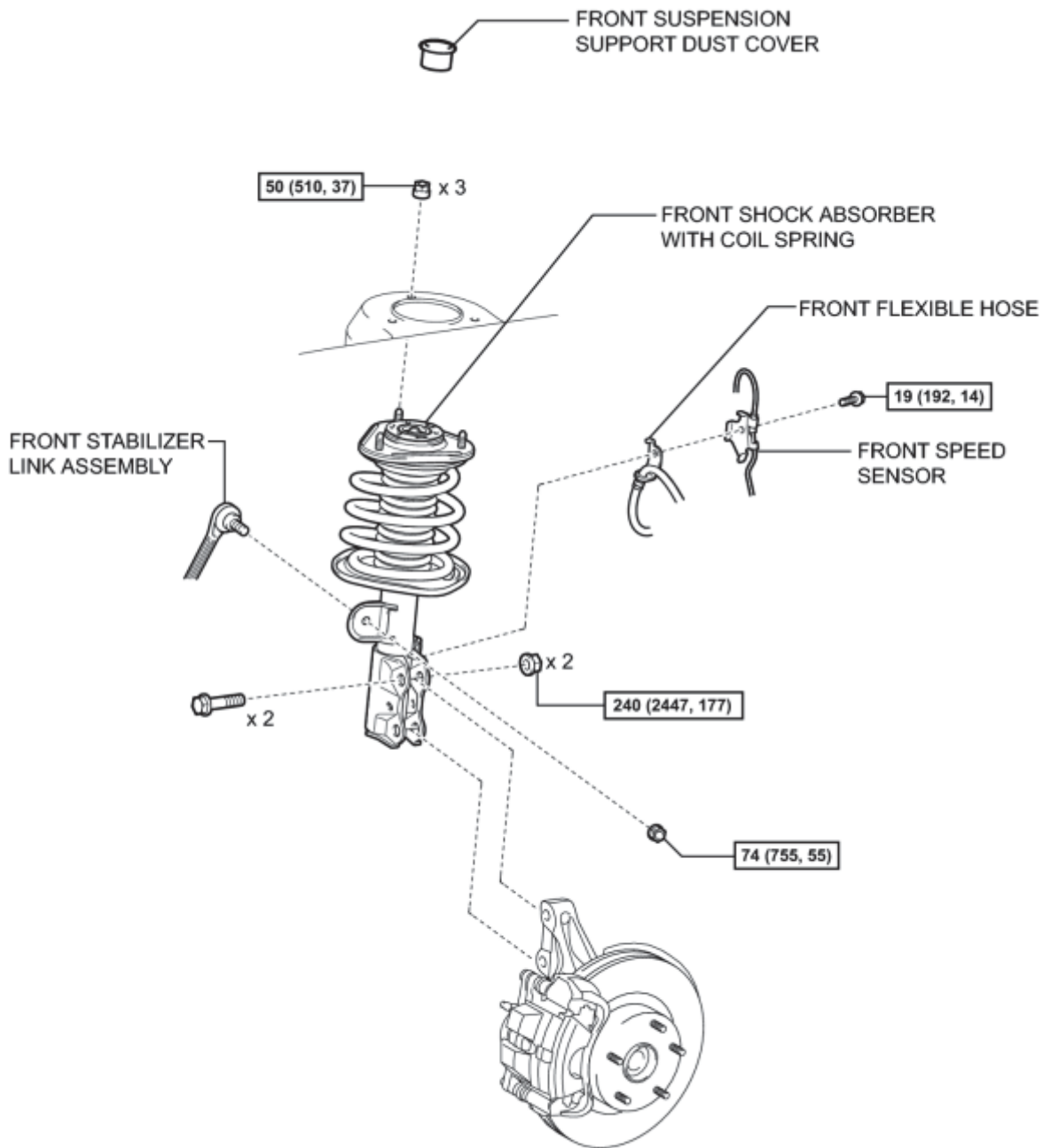

**N\*m (kgf\*cm, ft.\*lbf)**: Specified torque

c

## ILLUSTRATION

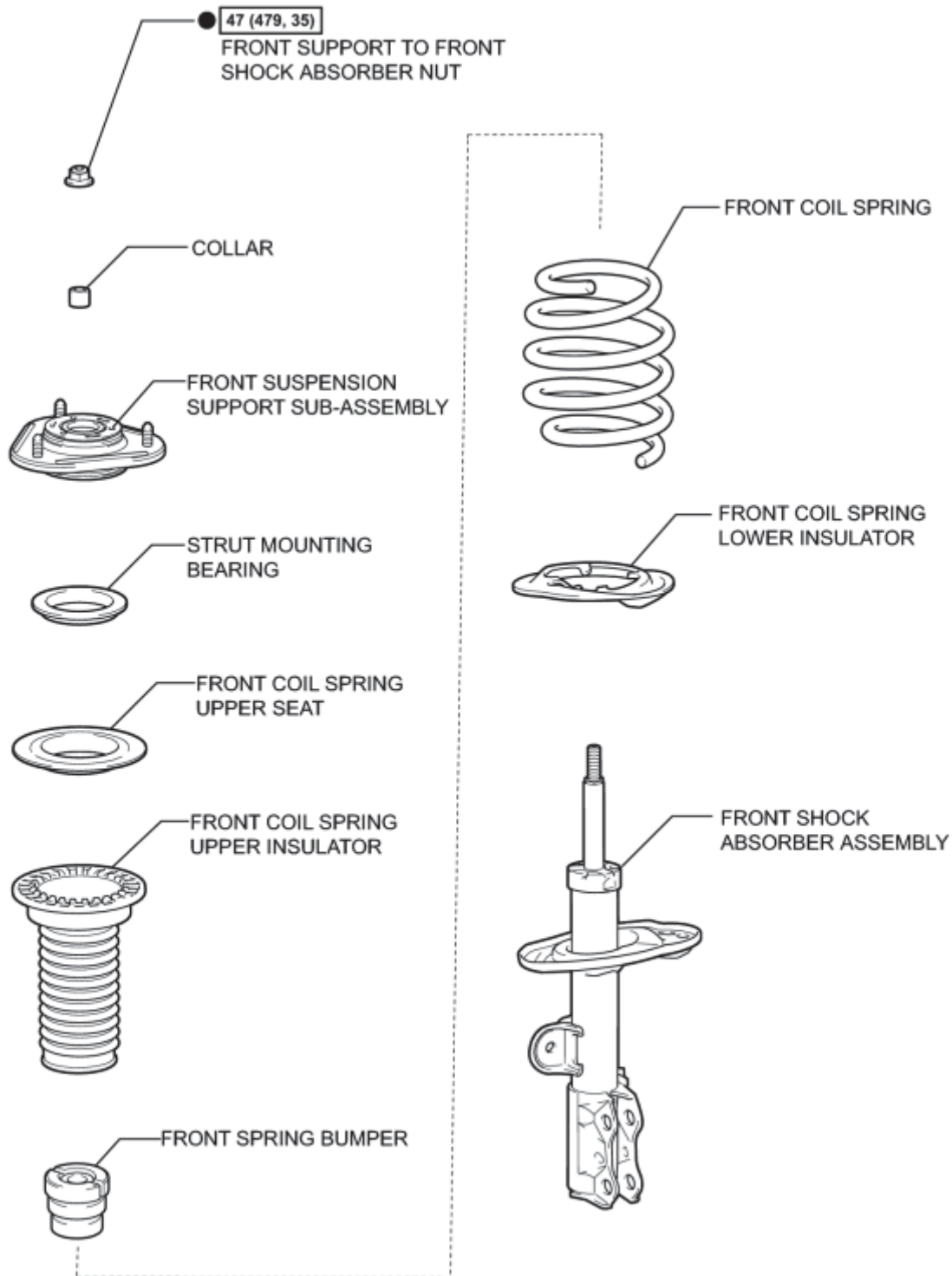

**N\*m (kgf\*cm, ft.\*lbf)**: Specified torque

● Non-reusable part

c

# REMOVAL

## HINT:

- Use the same procedure for the LH side and RH side.
- The procedure listed below is for the LH side.

### 1. REMOVE FRONT WHEEL

### 2. REMOVE WINDSHIELD WIPER MOTOR AND LINK ASSEMBLY

## HINT:

Refer to the procedure up to Remove Windshield Wiper Motor and Link Assembly INFO.

### 3. REMOVE COWL BODY MOUNTING REINFORCEMENT LH\_ INFO

### 4. REMOVE OUTER COWL TOP PANEL SUB-ASSEMBLY\_ INFO

### 5. SEPARATE FRONT STABILIZER LINK ASSEMBLY

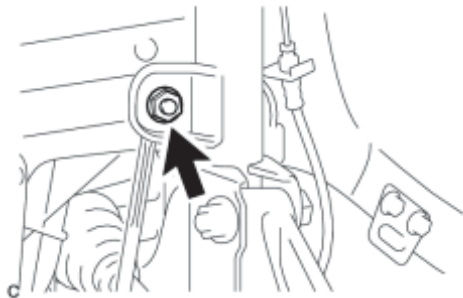

(a) Remove the nut and separate the stabilizer link assembly from the front shock absorber with coil spring.

## HINT:

If the ball joint turns together with the nut, use a hexagon wrench (6 mm) to hold the stud bolt.

### 6. SEPARATE FRONT SPEED SENSOR

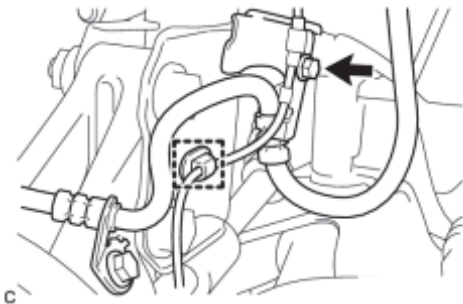

(a) Remove the bolt and clamp, and separate the front speed sensor and front flexible hose from the front shock absorber with coil spring.

## NOTICE:

Be sure to separate the front speed sensor from the front shock absorber with coil spring completely.

### 7. REMOVE FRONT SUSPENSION SUPPORT DUST COVER

(a) Remove the front suspension support dust cover.

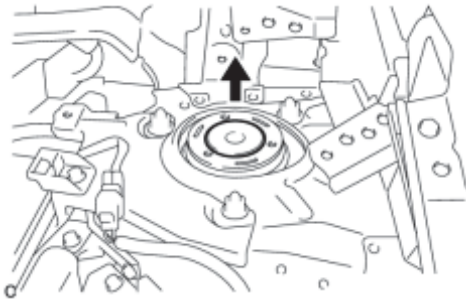

## 8. REMOVE FRONT SHOCK ABSORBER WITH COIL SPRING



(a) Loosen the front support to front shock absorber nut of the front shock absorber.

- Do not remove the front support to front shock absorber nut.
- Loosen the nut only when the front shock absorber with coil spring needs to be disassembled.

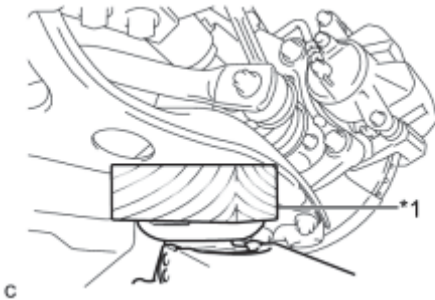

(b) Support the front axle using a jack and wooden block.

### Text in Illustration

*1	Wooden Block
----	--------------

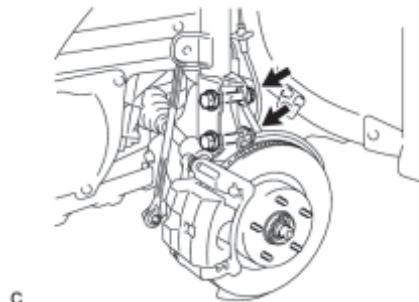

(c) Remove the 2 bolts and 2 nuts, and separate the front shock absorber with coil spring (lower side) from the steering knuckle.

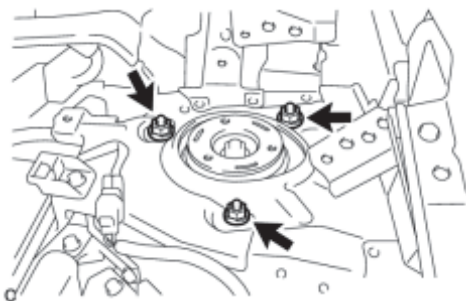

(d) Remove the 3 nuts and front shock absorber with coil spring.

### NOTICE:

Make sure that the front speed sensor is completely separated from the front shock absorber with coil spring.

## 9. SECURE FRONT SHOCK ABSORBER WITH COIL SPRING

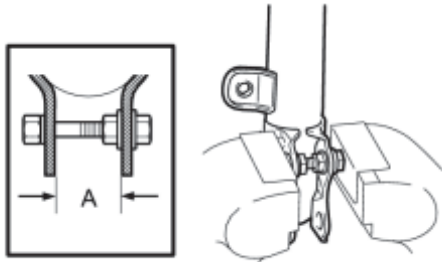

(a) Install a bolt and nut to the front shock absorber as shown in the illustration and secure the front shock absorber in a vise.

Standard length A:

40 mm (1.575 in.)

c

## 10. REMOVE FRONT SUPPORT TO FRONT SHOCK ABSORBER NUT

(a) Using SST, compress the front coil spring.

SST: 09727-30021

09727-00010

09727-00021

09727-00031

NOTICE:

Do not use an impact wrench. It will damage SST.

HINT:

If the front coil spring is compressed at an angle, using 2 SST will make the work easier.

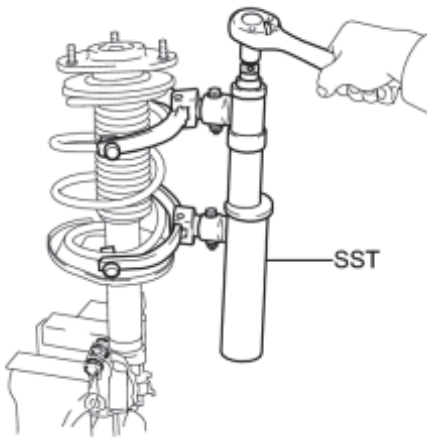

c

(b) Check that the front coil spring is sufficiently compressed.

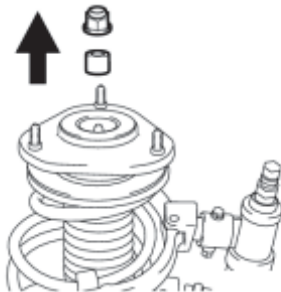

(c) Remove the front support to front shock absorber nut and collar.

P

## 11. REMOVE FRONT SUSPENSION SUPPORT SUB-ASSEMBLY

## 12. REMOVE STRUT MOUNTING BEARING

## 13. REMOVE FRONT COIL SPRING UPPER SEAT

14. REMOVE FRONT COIL SPRING UPPER INSULATOR
15. REMOVE FRONT COIL SPRING
16. REMOVE FRONT SPRING BUMPER
17. REMOVE FRONT COIL SPRING LOWER INSULATOR
18. REMOVE FRONT SHOCK ABSORBER ASSEMBLY

# INSPECTION

## 1. INSPECT FRONT SHOCK ABSORBER ASSEMBLY



P

(a) Compress and extend the shock absorber rod 4 times or more.

Standard:

There is no abnormal resistance or sound.

HINT:

If there is any abnormality, replace the front shock absorber assembly with a new one.



# INSTALLATION

## HINT:

- Use the same procedure for the LH side and RH side.
- The procedure listed below is for the LH side.

### 1. SECURE FRONT SHOCK ABSORBER ASSEMBLY

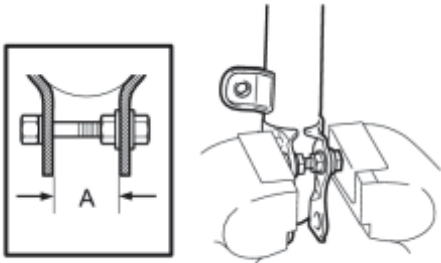

(a) Install the bolt and nut to the front shock absorber as shown in the illustration and secure the front shock absorber in a vise.

Standard length A:

40 mm (1.575 in.)

c

### 2. INSTALL FRONT COIL SPRING LOWER INSULATOR

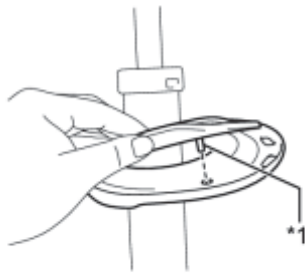

(a) Install the front coil spring lower insulator to the front shock absorber assembly.

#### Text in Illustration

*1	Positioning Pin
*2	Depression

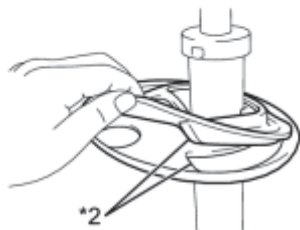

#### NOTICE:

When installing the insulator, fit the insulator to the depression of the spring seat and align the positioning pin into the hole.

c

### 3. INSTALL FRONT SPRING BUMPER

(a) Install the front spring bumper to the front shock absorber assembly.

#### NOTICE:

Face the smaller diameter end of the front spring bumper downward.

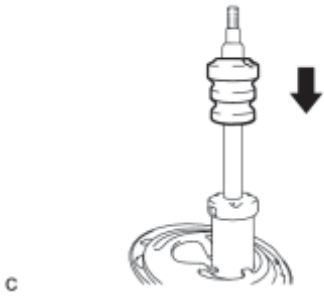

c

#### 4. INSTALL FRONT COIL SPRING

(a) Using SST, compress the front coil spring.

SST: 09727-30021

09727-00010

09727-00021

09727-00031

NOTICE:

Do not use an impact wrench. It will damage the SST.

HINT:

If the front coil spring is compressed at an angle, using 2 SST will make the work easier.

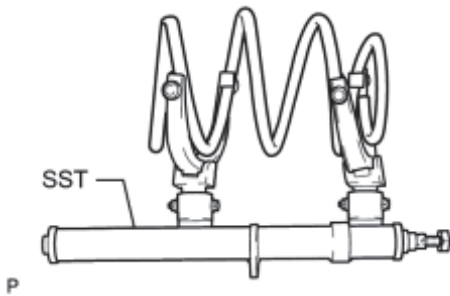

P

(b) Install the front coil spring.

### Text in Illustration

*1	Paint Mark
----	------------

- Make sure that the end of the front coil spring is positioned in the depression of the lower spring seat.
- Make sure to install the coil spring with the paint mark facing downward.

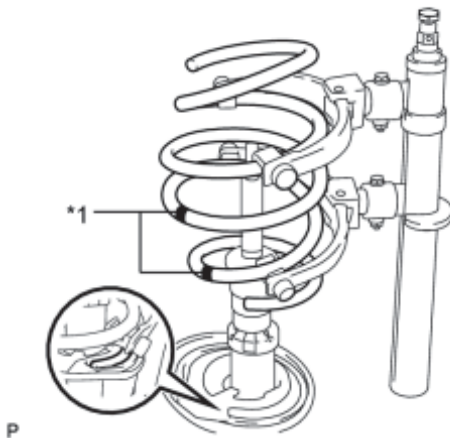

P

#### 5. INSTALL FRONT COIL SPRING UPPER INSULATOR

#### 6. INSTALL FRONT COIL SPRING UPPER SEAT

#### 7. INSTALL STRUT MOUNTING BEARING

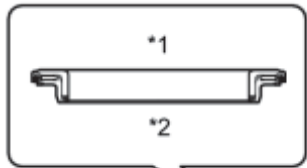

(a) Install the strut mounting bearing.

### Text in Illustration

*1	Upper Side
*2	Lower Side

NOTICE:

Do not install the bearing upside down.

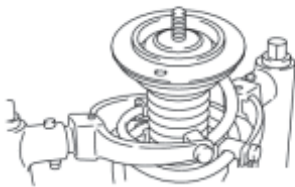

c

## 8. INSTALL FRONT SUSPENSION SUPPORT SUB-ASSEMBLY

(a) Install the front suspension support sub-assembly to the front shock absorber assembly.

NOTICE:

When installing, align the cutout on the front suspension support sub-assembly and the shock absorber piston rod end.

## 9. TEMPORARILY TIGHTEN FRONT SUPPORT TO FRONT SHOCK ABSORBER NUT

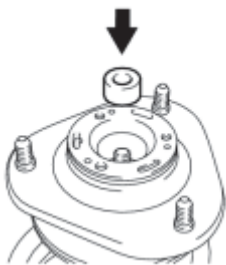

c

(a) Install the collar to the front shock absorber assembly.

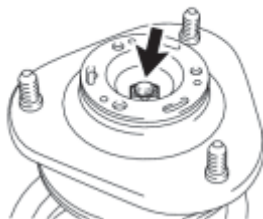

c

(b) Temporarily tighten a new front support to front shock absorber nut.

(c) Remove SST from the front coil spring.

NOTICE:

Do not use an impact wrench. It will damage SST.

## 10. INSTALL FRONT SHOCK ABSORBER WITH COIL SPRING

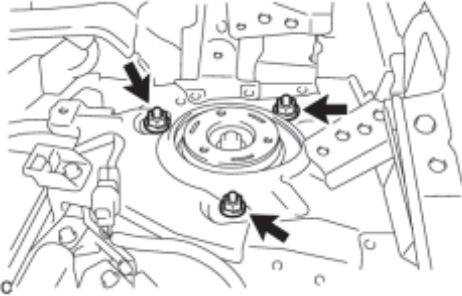

(a) Install the front shock absorber with coil spring (upper side) with the 3 nuts.

Torque: **50 N·m (510 kgf·cm, 37ft·lbf)**



(b) Install the front shock absorber with coil spring (lower side) to the steering knuckle with the 2 bolts and 2 nuts.

Torque: **240 N·m (2447 kgf·cm, 177ft·lbf)**

NOTICE:

While keeping the bolts from rotating, tighten the nuts.

c

## 11. FULLY TIGHTEN FRONT SUPPORT TO FRONT SHOCK ABSORBER NUT



(a) Fully tighten the front support to front shock absorber nut.

Torque: **47 N·m (479 kgf·cm, 35ft·lbf)**

## 12. INSTALL FRONT SUSPENSION SUPPORT DUST COVER

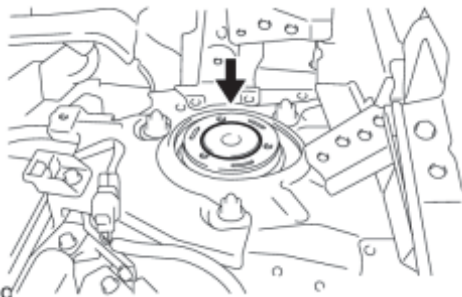

(a) Install the front suspension support dust cover.

## 13. INSTALL FRONT SPEED SENSOR

(a) Install the front speed sensor and front flexible hose to the front shock

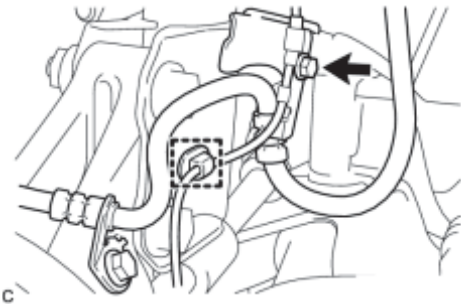

absorber with the bolt and clamp.

Torque: **19 N·m (192 kgf·cm, 14ft·lbf)**

NOTICE:

Do not twist the front speed sensor when installing it.

HINT:

Install the front flexible hose first and then the speed sensor harness bracket.

#### 14. INSTALL FRONT STABILIZER LINK ASSEMBLY

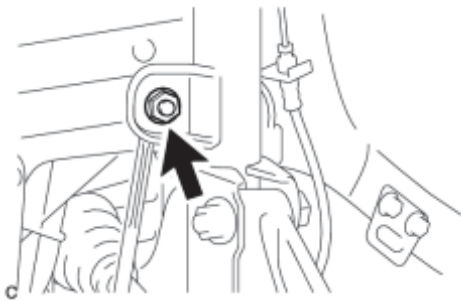

(a) Install the front stabilizer link assembly to the front shock absorber with coil spring with the nut.

Torque: **74 N·m (755 kgf·cm, 55ft·lbf)**

HINT:

If the ball joint turns together with the nut, use a hexagon wrench (6 mm) to hold the stud bolt.

#### 15. INSTALL OUTER COWL TOP PANEL SUB-ASSEMBLY\_ INFO

#### 16. INSTALL COWL BODY MOUNTING REINFORCEMENT LH\_ INFO

#### 17. INSTALL WINDSHIELD WIPER MOTOR AND LINK ASSEMBLY

HINT:

Refer to the procedure from Install Windshield Wiper Motor and Link Assembly INFO.

#### 18. INSTALL FRONT WHEEL

Torque: **103 N·m (1050 kgf·cm, 76ft·lbf)**

#### 19. INSPECT AND ADJUST FRONT WHEEL ALIGNMENT

HINT:

Inspect and adjust the front wheel alignment INFO.

# DISPOSAL

## 1. DISPOSE OF FRONT SHOCK ABSORBER ASSEMBLY

(a) Position the front shock absorber assembly level with the piston rod fully extended. Using a drill, make a hole in the cylinder between A and B shown in the illustration to discharge the gas inside.

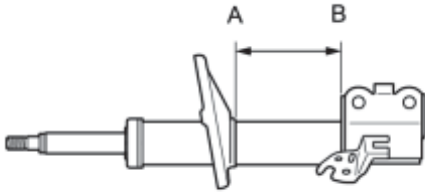

NOTICE:

Always use proper safety equipment and be careful when drilling because shards of metal fly about.

HINT:

The gas is colorless, odorless and non-poisonous.

P