

# COMPONENTS

## ILLUSTRATION

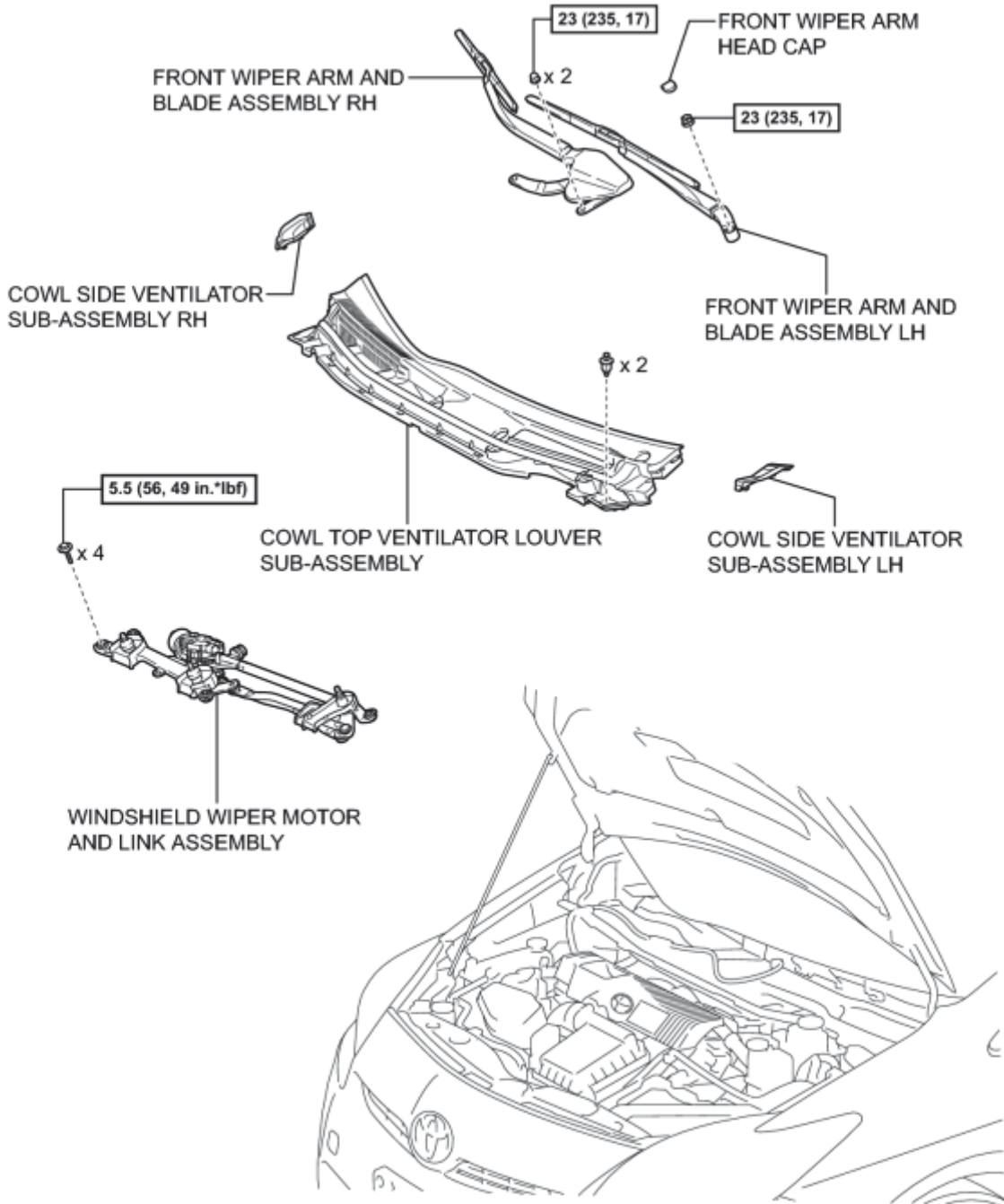

**N·m (kgf·cm, ft.·lbf):** Specified torque

P

## ILLUSTRATION

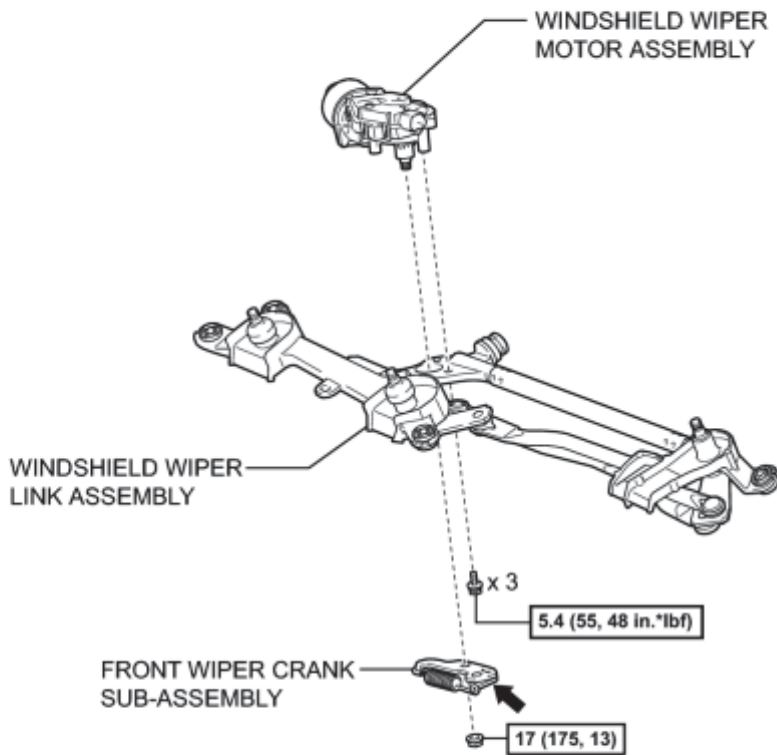

**N\*m (kgf\*cm, ft.\*lbf)**: Specified torque

← MP grease

P

# ON-VEHICLE INSPECTION

## 1. INSPECT WINDSHIELD WIPER MOTOR ASSEMBLY

(a) for LH Side

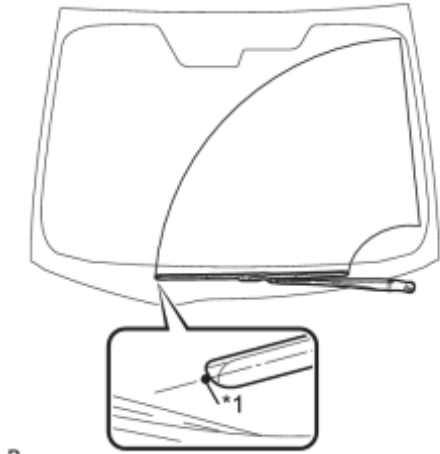

(1) Operate the windshield wiper motor assembly.

P

(2) Stop the windshield wiper motor assembly operation.

(3) Check the automatic stop (park) position.

OK:

The front wiper stops at the position shown in the illustration.

### *Text in Illustration*

*1	Ceramic Dot
----	-------------

(b) for RH Side

(1) Operate the windshield wiper motor assembly.

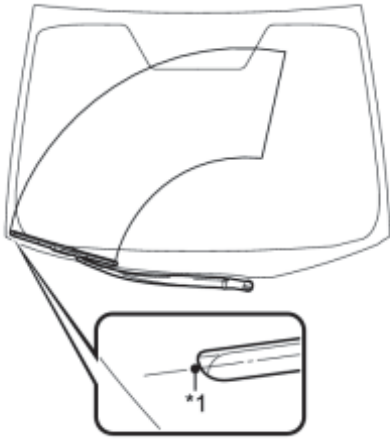

P

(2) Stop the windshield wiper motor assembly operation.

(3) Check the automatic stop (park) position.

OK:

The front wiper stops at the position shown in the illustration.

***Text in Illustration***

*1	Ceramic Dot
----	-------------

# REMOVAL

## 1. REMOVE FRONT WIPER ARM HEAD CAP

(a) Using a screwdriver, disengage the 3 claws and remove the front wiper arm head cap.

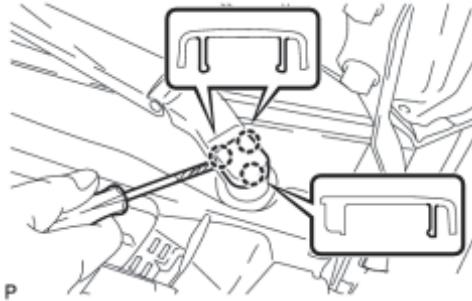

### Text in Illustration

*1	Protective Tape
----	-----------------

- Tape the screwdriver tip before use.
- Use the same procedure for the RH side and LH side.

## 2. REMOVE FRONT WIPER ARM AND BLADE ASSEMBLY LH

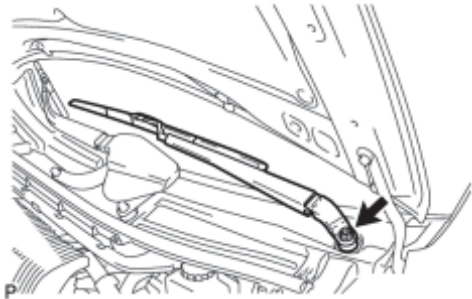

(a) Remove the nut and the front wiper arm and blade assembly LH.

## 3. REMOVE FRONT WIPER ARM AND BLADE ASSEMBLY RH

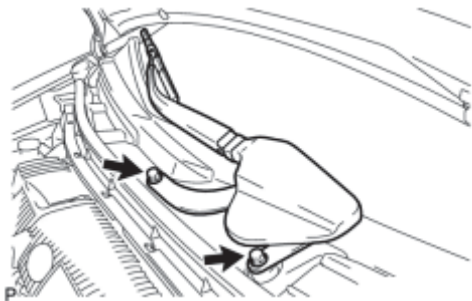

(a) Remove the 2 nuts and the front wiper arm and blade assembly RH.

## 4. REMOVE COWL SIDE VENTILATOR SUB-ASSEMBLY LH

(a) Using a screwdriver, disengage the claw and guide <A> as shown in the illustration.

### Text in Illustration

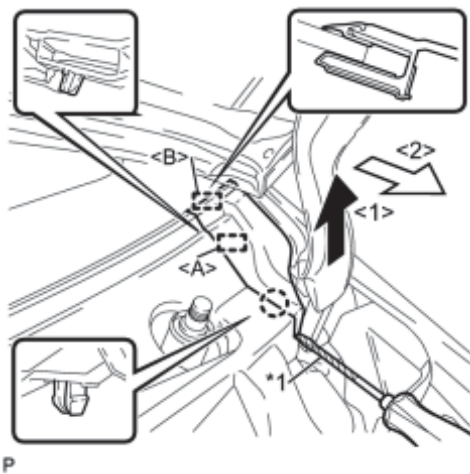

*1	Protective Tape
----	-----------------

HINT:  
Tape the screwdriver tip before use.

(b) Disengage the guide <B> and remove the cowl side ventilator sub-assembly LH as shown in the illustration.

**5. REMOVE COWL SIDE VENTILATOR SUB-ASSEMBLY RH**

HINT:  
Use the same procedure for the RH side and LH side.

**6. REMOVE COWL TOP VENTILATOR LOUVER SUB-ASSEMBLY**

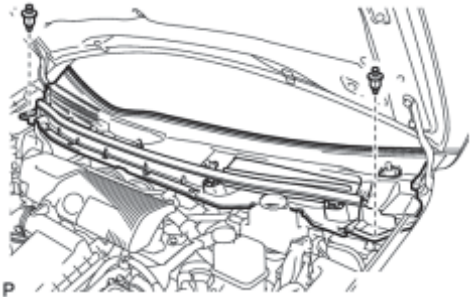

(a) Remove the 2 clips.

(b) Disengage the 5 claws and 3 guides <A>.

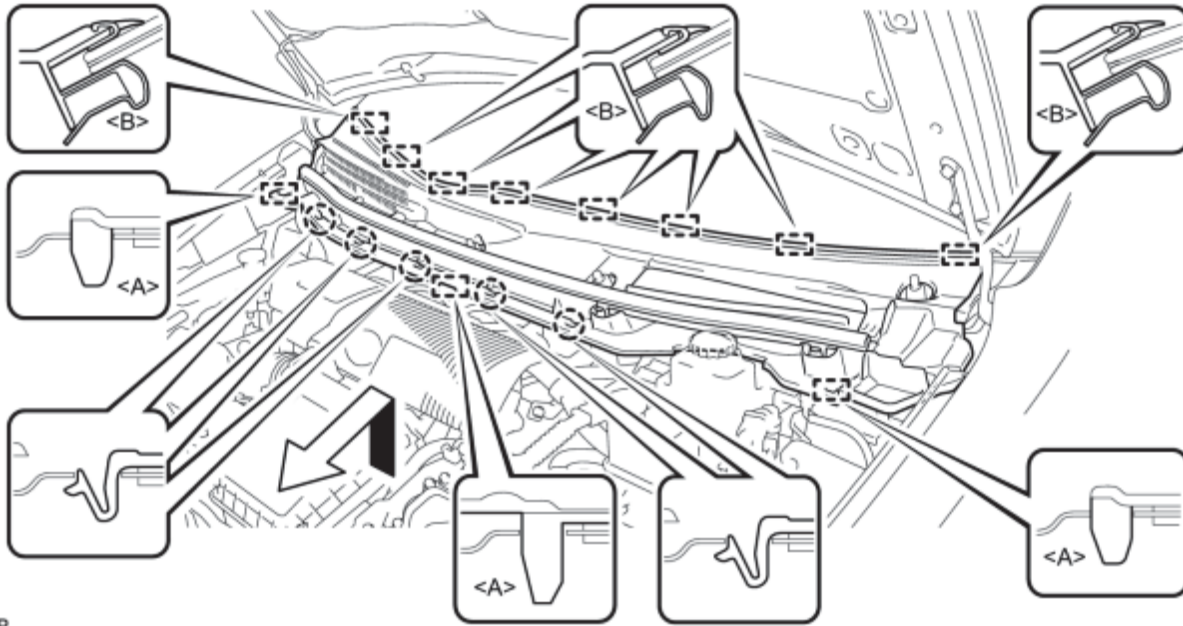

(c) Disengage the 8 guides <B> and pull out the cowl top ventilator louver sub-assembly as shown in the illustration.

## 7. REMOVE WINDSHIELD WIPER MOTOR AND LINK ASSEMBLY

(a) Operate the wiper and stop the windshield wiper motor at the automatic stop position.

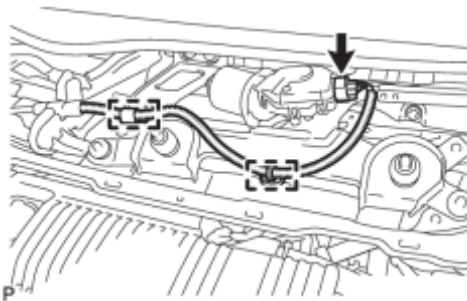

(b) Disconnect the connector.

(c) Disengage the 2 clamps.

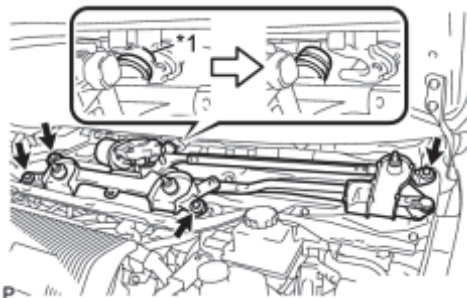

(d) Remove the 4 bolts.

### Text in Illustration

\*1 Grommet

(e) Disengage the grommet and remove the windshield wiper motor and link assembly as shown in the illustration.

**NOTICE:**

Be careful not to damage the windshield when removing the windshield wiper motor and link assembly.

**8. REMOVE FRONT WIPER CRANK SUB-ASSEMBLY**

(a) Using a screwdriver, separate the windshield wiper link rod from the crank arm pivot of the front wiper crank sub-assembly as shown in the illustration.

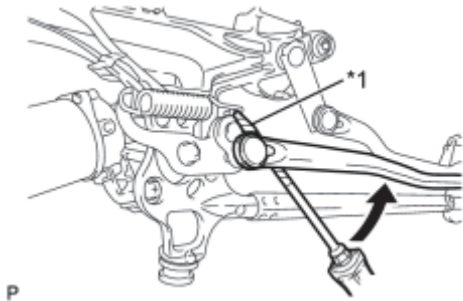

**Text in Illustration**

*1	Protective Tape
----	-----------------

**HINT:**

Tape the screwdriver tip before use.

(b) When reusing the windshield wiper motor assembly and front wiper crank sub-assembly:

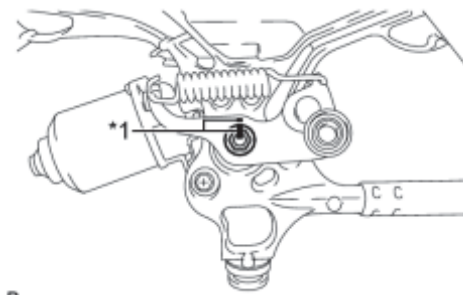

(1) Place matchmarks on the windshield wiper link assembly and front wiper crank sub-assembly as shown in the illustration.

**Text in Illustration**

*1	Matchmark
----	-----------

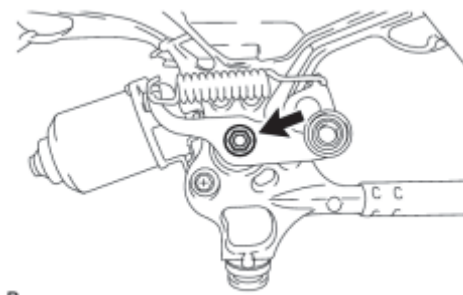

(c) Remove the nut and the front wiper crank sub-assembly.

**9. REMOVE WINDSHIELD WIPER MOTOR ASSEMBLY**

(a) Remove the 3 bolts and remove the windshield wiper motor assembly.



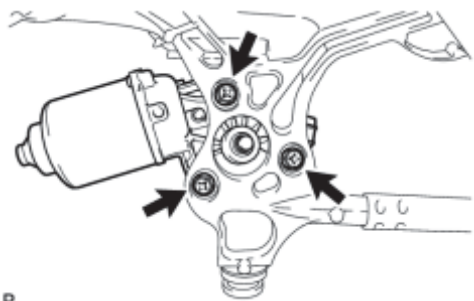

P

# INSPECTION

## NOTICE:

Ensure that fingers or articles of clothing do not get caught in moving parts when performing this test.

### 1. INSPECT WINDSHIELD WIPER MOTOR ASSEMBLY

\*1

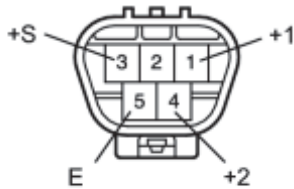

(a) Check the low speed operation.

(1) Connect a battery positive (+) lead to terminal 1 (+1) and a negative (-) lead to terminal 5 (E), and check that the motor operates at low speed.

OK:

Motor operates at low speed.

P

(b) Check the high speed operation.

(1) Connect a battery positive (+) lead to terminal 4 (+2) and a negative (-) lead to terminal 5 (E), and check that the motor operates at high speed.

OK:

Motor operates at high speed.

#### *Text in Illustration*

*1	Component without harness connected (Windshield Wiper Motor Assembly)
----	--

If the result is not as specified, replace the windshield wiper motor assembly.

# INSTALLATION

## 1. INSTALL WINDSHIELD WIPER MOTOR ASSEMBLY

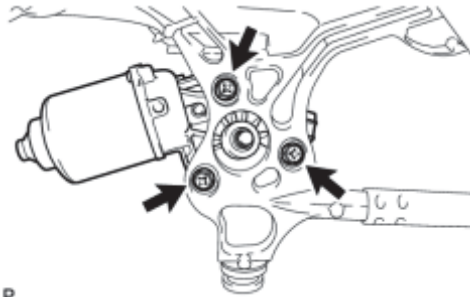

(a) Install the windshield wiper motor assembly with the 3 bolts.

Torque: **5.4 N·m (55 kgf·cm, 48in·lbf)**

P

## 2. INSTALL FRONT WIPER CRANK SUB-ASSEMBLY

(a) When replacing the windshield wiper motor assembly and front wiper crank sub-assembly with a new one:

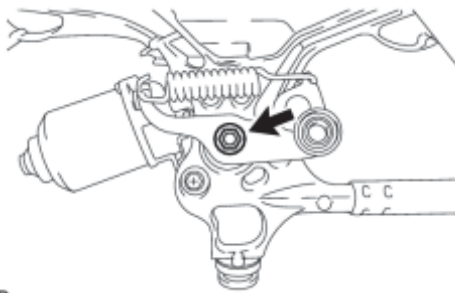

(1) Temporarily install a front wiper crank sub-assembly on the new windshield wiper motor assembly with the nut.

P

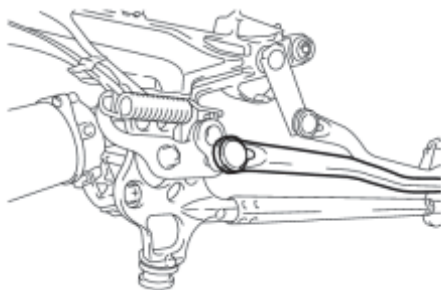

(2) Temporarily install the windshield wiper motor and link on the crank arm pivot of the front wiper crank sub-assembly.

P

(3) Align the front wiper crank sub-assembly with the windshield wiper motor and link as shown in the illustration.

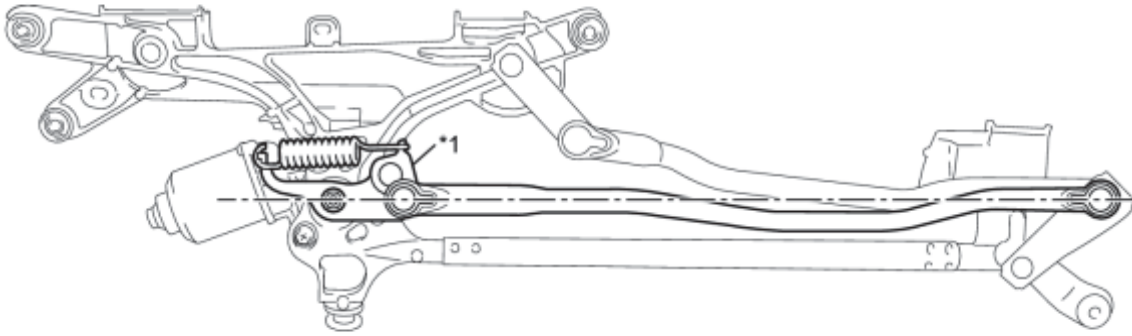

P

**Text in Illustration**

*1	Front Wiper Crank Sub-assembly
----	--------------------------------

(4) Tighten install the front wiper crank sub-assembly with the nut.

Torque: **17 N·m (175 kgf·cm, 13ft·lbf)**

(b) When reusing the windshield wiper motor assembly and front wiper crank sub-assembly:

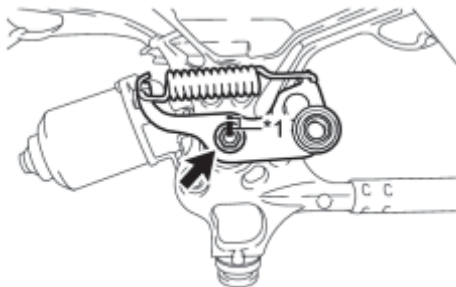

(1) Align the matchmarks to install the front wiper crank sub-assembly with the nut.

**Text in Illustration**

*1	Matchmark
----	-----------

P

Torque: **17 N·m (175 kgf·cm, 13ft·lbf)**

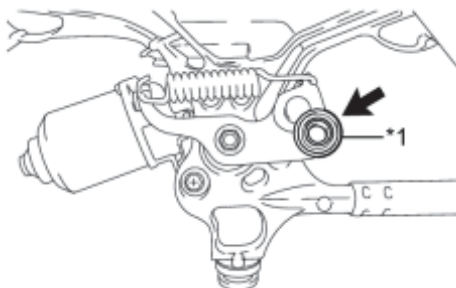

(c) Apply MP grease to the crank arm pivot of the front wiper crank sub-assembly.

**Text in Illustration**

*1	Crank arm Pivot
----	-----------------

P

(d) Connect the rod of the windshield wiper link assembly to the crank arm pivot of the front wiper crank sub-assembly.

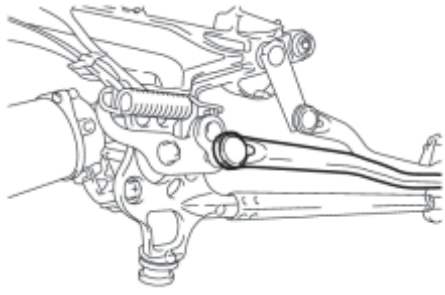

P

### 3. INSTALL WINDSHIELD WIPER MOTOR AND LINK ASSEMBLY

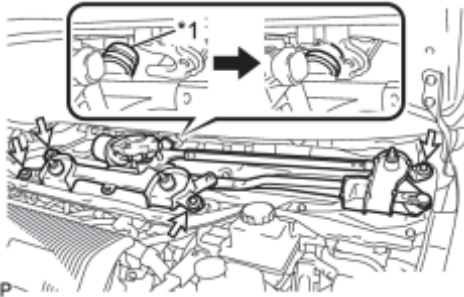

P

(a) Engage the grommet as shown in the illustration.

#### Text in Illustration

*1	Grommet
----	---------

(b) Install the windshield wiper motor and link assembly with the 4 bolts.

Torque: **5.5 N·m (56 kgf·cm, 49in·lbf)**

#### NOTICE:

Be careful not to damage the windshield when installing the windshield wiper motor and link assembly.

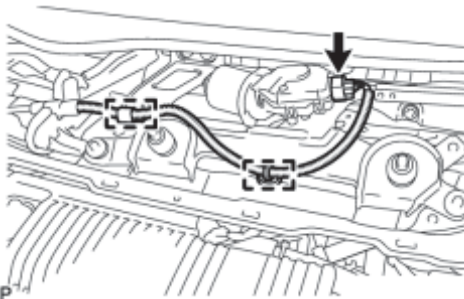

P

(c) Engage the 2 clamps.

(d) Connect the connector.

### 4. INSTALL COWL TOP VENTILATOR LOUVER SUB-ASSEMBLY

(a) Engage the 8 guides <B>.

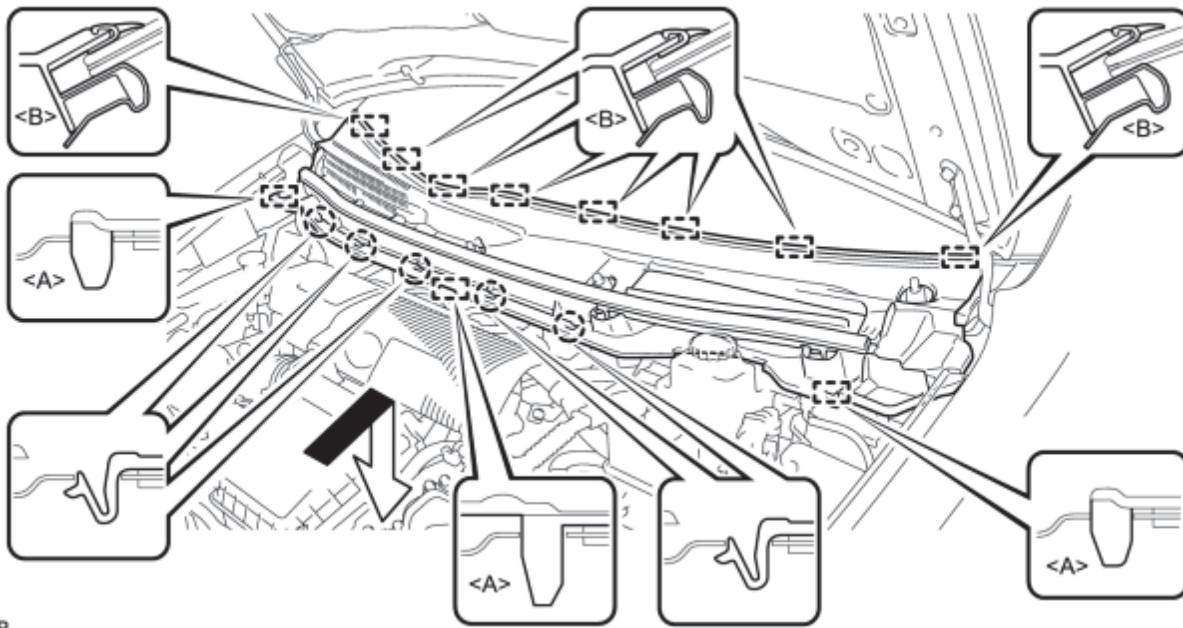

P

(b) Engage the 5 claws and 3 guides <A> to install the cowl top ventilator louver sub-assembly as shown in the illustration.

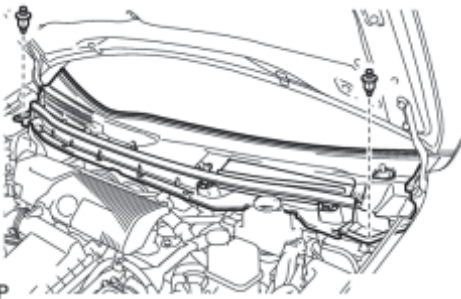

P

(c) Install the 2 clips.

## 5. INSTALL COWL SIDE VENTILATOR SUB-ASSEMBLY LH

(a) Engage the guide <B> as shown in the illustration.

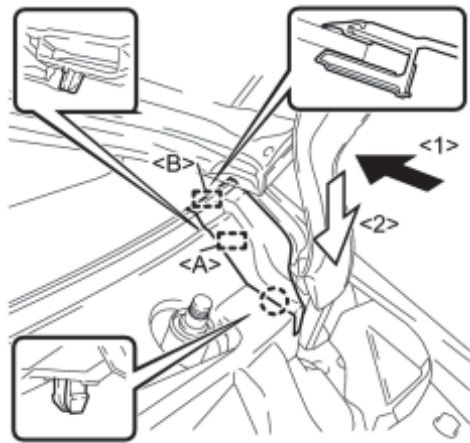

(b) Engage the claw and guide <A> to install the cowl side ventilator sub-assembly LH as shown in the illustration.

#### 6. INSTALL COWL SIDE VENTILATOR SUB-ASSEMBLY RH

HINT:

Use the same procedure for the RH side and LH side.

#### 7. INSTALL FRONT WIPER ARM AND BLADE ASSEMBLY RH

(a) Operate the wiper and stop the windshield wiper motor at the automatic stop position.

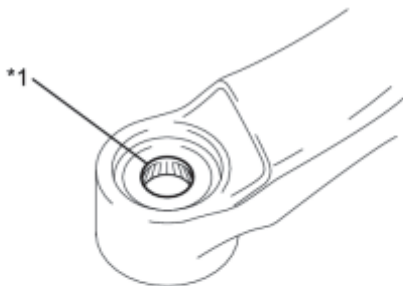

(b) When reusing the front wiper arm and blade assembly RH:

(1) Clean the wiper arm serrations.

#### Text in Illustration

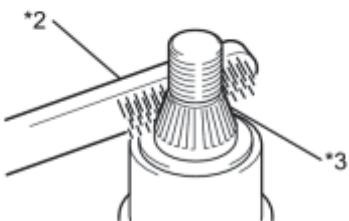

*1	Wiper Arm Serration
*2	Wire Brush
*3	Wiper Pivot Serration

(c) When reusing the windshield wiper link assembly:

(1) Clean the wiper pivot serrations with a wire brush.

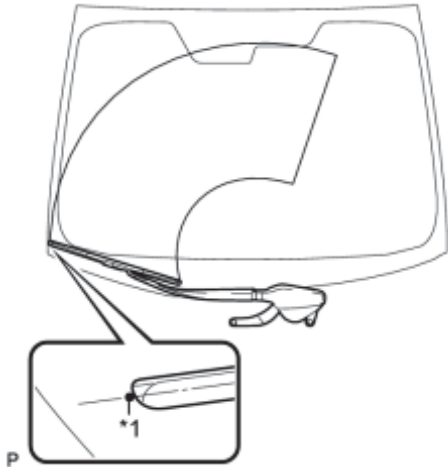

(d) Install the front wiper arm and blade assembly RH with the 2 nuts to the position shown in the illustration.

Torque: **23 N·m (235 kgf·cm, 17ft·lbf)**

### Text in Illustration

*1	Ceramic Dot
----	-------------

HINT:

Hold the wiper arm by hand while tightening the nut.

## 8. INSTALL FRONT WIPER ARM AND BLADE ASSEMBLY LH

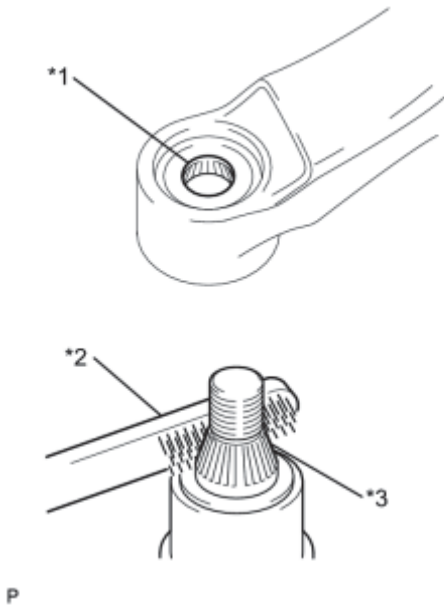

(a) When reusing the front wiper arm and blade assembly LH:

(1) Clean the wiper arm serrations.

### Text in Illustration

*1	Wiper Arm Serration
*2	Wire Brush
*3	Wiper Pivot Serration

(b) When reusing the windshield wiper link assembly:

(1) Clean the wiper pivot serrations with a wire brush.

(c) Install the front wiper arm and blade assembly LH with the nut to the position shown in the illustration.

Torque: **23 N·m (235 kgf·cm, 17ft·lbf)**





## Text in Illustration

*1	Ceramic Dot
----	-------------

HINT:

Hold the wiper arm by hand while tightening the nut.

P

(d) Operate the front wipers while spraying washer fluid on the windshield glass. Make sure that the front wipers function properly and there is no interference with the vehicle body.

### 9. INSTALL FRONT WIPER ARM HEAD CAP

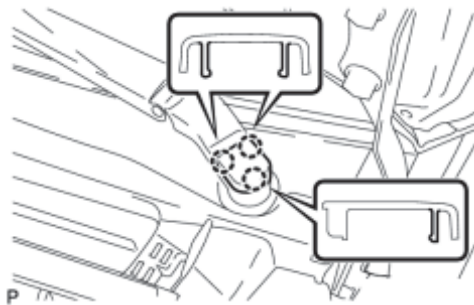

(a) Engage the 3 claws to install the front wiper arm head cap.

HINT:

Use the same procedure for the RH side and LH side.

P