

Vertical Arrow TypeL (AV-029) Prius50 PHV Camry70 Turn Signal Lamp Manual

AVEST

Thank you for purchasing our product.
Please read the instruction manual carefully and use the product.
This is a general instruction manual for the maintenance service. Therefore, some of the methods of mounting and dismantling the product vary by vehicle.

Please check the contents of your package

[Package List]

- Side Mirror TURN SIGNAL LED LAMP & Cover(lower part) 1 set (Right & Left)
- Extension Wire
- Switch (Red & Black 1 pc each)

Cautions

- Please ask professional mechanics with knowledge for installation for safety and proper function.
- Please disconnect the negative terminal cable from the battery when installing the product.
- We are NOT responsible for any damages, consequences damages and injury by installing, operating and using our products.
- Our products might NOT function properly when your vehicle is installed with other company's electric devices such as LED.

Other Notes

- Please contact: your local post office for EMS or DHL agent for DHL delivery, if you've received the damaged products.
- Please send us the picture of the product by e-mail if you want to return the purchased product.
- You ARE responsible for original shipping charges, all applicable other fees and the cost of return shipping unless the item(s) received are faulty or not as ordered.
- If any defective is found, please report us or the purchased shop within 3 days from receiving or purchasing the item.
- You may not be refunded if the returned item is in a different condition.

AVEST CO., Ltd.
3-22-20 Takaokakita, Naka-ku
Hamamatsu-shi, Shizuoka-ken
Japan 433-8119
TEL: 81 53 (414) 5416
E-mail: kamo@avestparts.jp

Please ask professional mechanics with knowledge for installation for safety and proper function. Vehicle used for this manual is Prius 50. Some parts may vary depending on model year, type and grades. **[Important]**

- 1 Wiring, wire connection & lighting confirmation** *Please always check with a tester
Please confirm the place to take out the wire with a tester and length of extension wire.

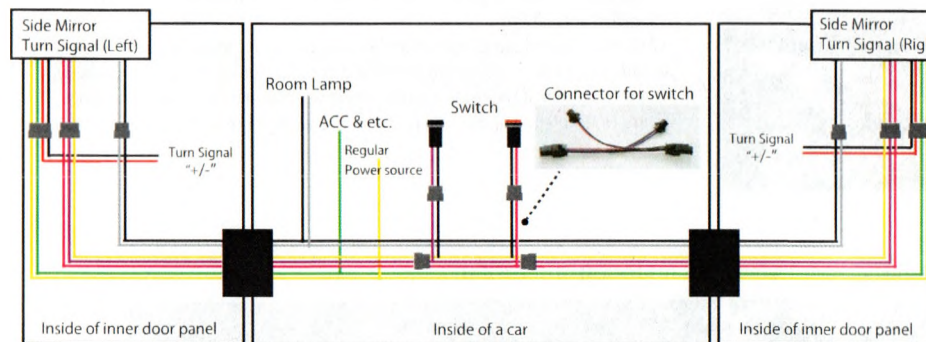

White/Black Wires...Welcome Wire White=Room Lamp Plus Black=Room Lamp Minus
If you connect to branching harness... Connect white wire to battery, Black wire to room lamp
Factory welcome light won't have enough brightness due to low voltage. Option foot lamp for driver seat is possible to connect.

Yellow/Green/Red/Black wires...Yellow→Connect to permanent PS via the harness of the fuse box
Green→DRL lamp plus Connect to the place where you want it to be working together (Acc...etc)
Red→Turn Signal Plus ※Connect red and black wires close to the turn signal coupler inside the side mirror assy
Black→Turn Signal Minus

Pink/Purple/Yellow : Wire for Switch - Please connect it with the supplied connector inside of a car
As for switch, please connect it to the connectors in the same color.

※Red Switch...Turn signal mode change Sequential⇔Normal
Black Switch...DRL ON-OFF

Without connecting these switches, turn signal mode and DRL will not activate.

Caution: Please make sure to connect the yellow wire to the permanent power source. Sometimes it doesn't function properly when connecting all the wires such as blinker wire, ACC wires and etc. together. Please insulate the wires which are not in use: welcome lamp & etc. Be careful not to mix the yellow wire with the one for switch.

• Finding Puddle Lamp Wiring

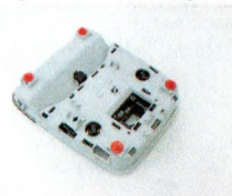

Remove the dome lamp unit.
Please remove it by referring the position of the red clip.



Please find the plus/minus wires from the connector by using a tester.
Wiring for the car in the pictures is
Red-Roomlamp Plus
Purple-Roomlamp Minus
Please use a test since it could be different between model year, grades and types.

Vertical Arrow TypeL (AV-029) Prius50 PHV Camry70 Turn Signal Lamp Manual

AVEST

2 Lighting Check

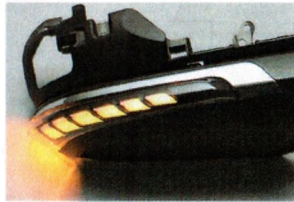

- Please note that we are NOT responsible for the initial failure found after installation. Therefore, please make sure to check the lighting with a tester at 12v before installation.
- Wire connection failure, connector failure and interference with other maker's product would be the reason if the tested product does not function properly after installation. If the reason is the interference with other maker's product, we are NOT able to support the problem. Please find the solution by yourself.

3 Side mirror turn signal light replacing and wiring



- ◆ Open the cover of door knob and remove the screws to remove the inner door panel.



- ◆ Remove the window switch panel. Remove it from the rear side with a panel remover.



- ◆ Remove a switch panel and the connectors on the back side. Remove two screws which fixing the door panel.



- ◆ Remove the courtesy lamp and the inner door panel.



- ◆ Remove the side mirror connector and three bolts which are located at the base of the side mirror. Then remove the side mirror.

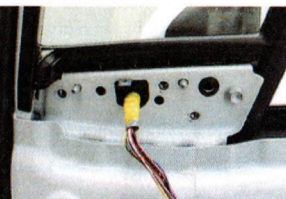

- ◆ Push the mirror until there is enough space at the lower part. Cover the tip of minus screw-driver with tape and put it between the back side of mirror and the white plastic part, then lift if so that lower part of the mirror will snap off. Then pull out the mirror carefully.



Remove the mirror from the side mirror.



Please ask professional mechanics with knowledge for installation for safety and proper function. Vehicle used for this manual is Prius 50. Some parts may vary depending on model year, type and grades. **[Important]**

- ◇ Remove the side mirror cover and replace the lens and connect the wires.

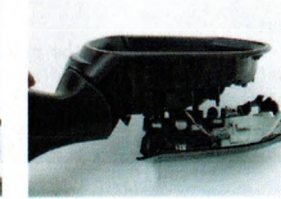

- ◆ Remove the upper cover by pressing the tab from back. Remove the screws on the bottom cover and remove it in the same procedure for the upper one.

- ◆ Remove the bottom cover. Please be careful not to damage the tabs. *Please insulate the turn signal connectors since they won't be used.

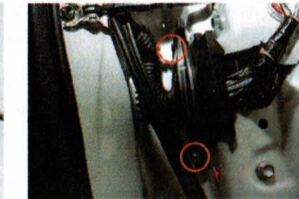

- ◆ Install the product and put the wires through where the motor wires are.

- ◆ Put the cover back to finish the installation.

- ◆ Put the extension cable through the rubber tube from the door to the inside of the vehicle. Please take 2 screws circled in red before operation.



- ◆ Remove the door connector and insert the pin to the free space. Please operate after removing the connector if necessary.

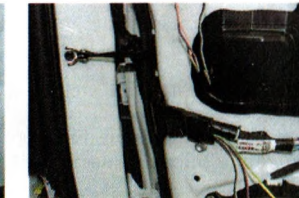
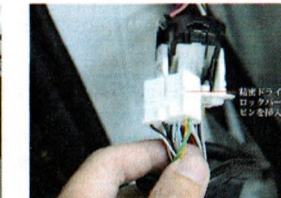

- ◆ Pull the extension cable to the inside of the car.

- ◇ Please connect wires by referring the wiring diagram on the page 1.

After confirming the lighting, please assemble them back in the reverse procedure of disassembly. Regarding the installation of a switch, please install it by your decision.

- ※ If the LED does not light up, please check if the pin and the power source are connected properly.
- ※ Please note that we're not responsible for any processing of the product.