

DESCRIPTION

In the exhaust heat recirculation system, coolant is warmed up using conventionally wasted exhaust gas heat to accelerate engine warm-up time, enhancing fuel efficiency and heater performance.

The heat recirculator is positioned in the front exhaust pipe assembly after the catalyst. Coolant from the engine flows around the heat recirculator and then returns to the engine. If the engine is started while the engine is cold, the exhaust pipe gas control actuator rod is contracted and the exhaust flow control valve is closed, routing the exhaust gas around the heat recirculator to warm up the coolant.

After the engine coolant temperature rises and the engine has warmed up, the heat of the coolant expands the thermostat and the exhaust pipe gas control actuator rod extends. This opens the exhaust flow control valve to switch to the normal exhaust gas path.

The exhaust flow control valve can also be opened by exhaust gas pressure to prevent insufficient acceleration performance when the engine is cold. In addition, to monitor the engine coolant temperature, a engine coolant temperature sensor (for exhaust heat recirculation system) is provided between the engine and the heat recirculator. The engine coolant temperature sensor (for exhaust heat recirculation system) has a built-in thermistor with a resistance that varies according to the temperature of the engine coolant. When the engine coolant temperature becomes low, the resistance of the thermistor increases. When the temperature becomes high, the resistance drops. These variations in resistance are transmitted to the No. 3 meter circuit plate as voltage changes. If the engine coolant temperature is excessively high (overheating), the water temperature indicator light in the No. 3 meter circuit plate illuminate to inform the driver of the malfunction.

Valve Closed:

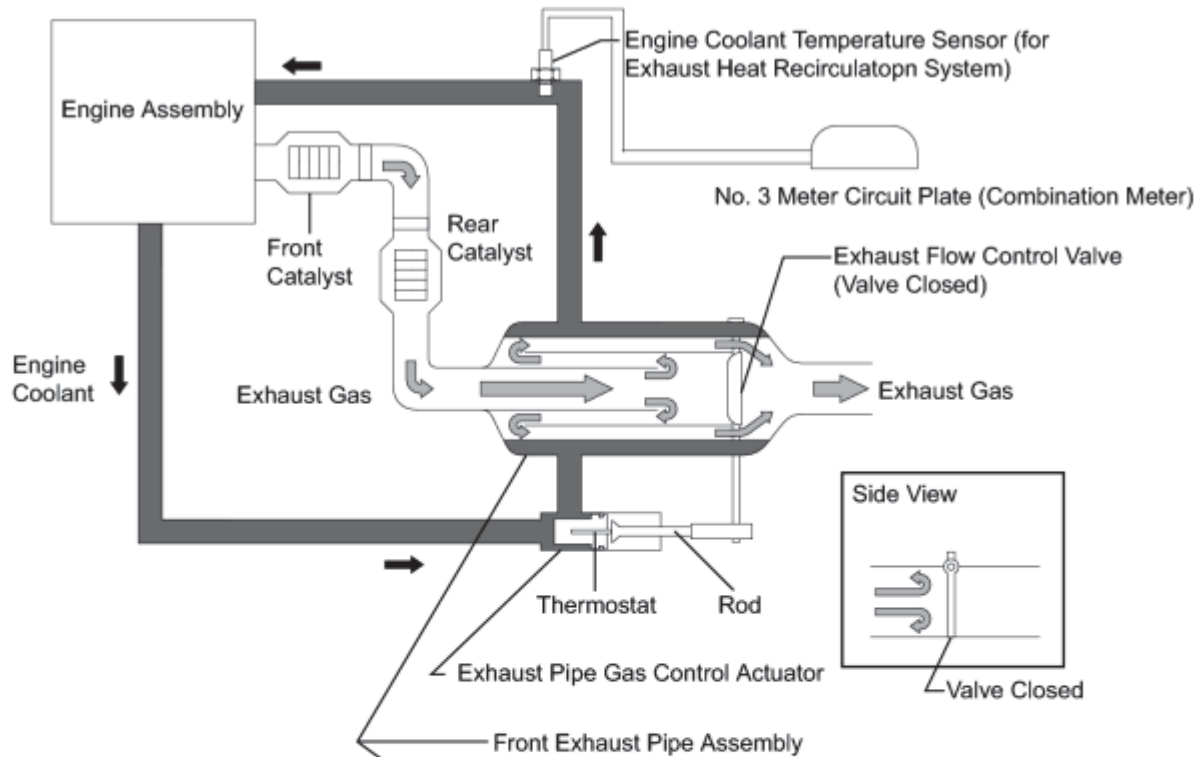

Valve Open:

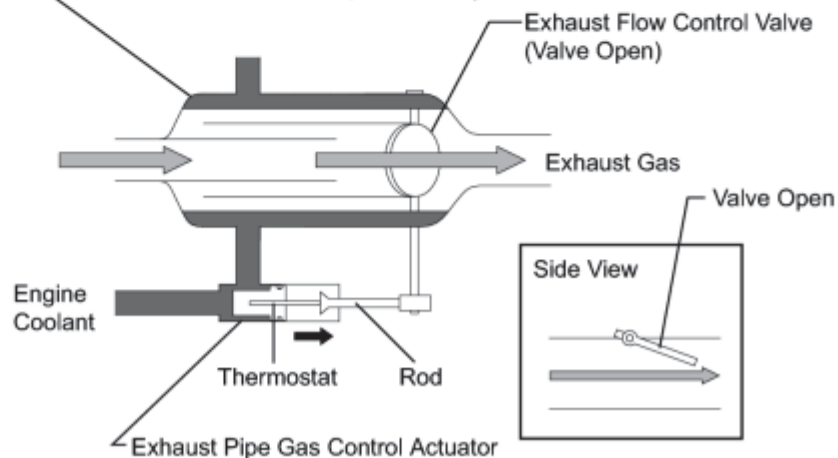

c

WIRING DIAGRAM

Refer to System Diagram .

INSPECTION PROCEDURE

PROCEDURE

| | |
|----|---|
| 1. | CHECK HARNESS AND CONNECTOR (ENGINE COOLANT TEMPERATURE SENSOR - COMBINATION METER) |
|----|---|

*1

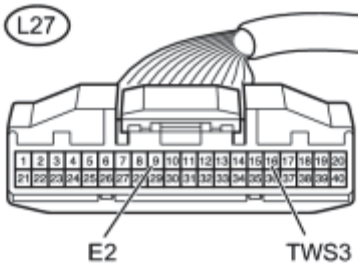

(a) Disconnect the engine coolant temperature sensor (for exhaust heat recirculation system) connector.

*2

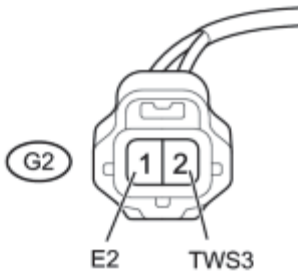

(b) Disconnect the No. 3 meter circuit plate connector.

(c) Measure the resistance according to the value(s) in the table below.

Standard Resistance (Check for Open):

| Tester Connection | Condition | Specified Condition |
|-----------------------------|-----------|---------------------|
| G2-2 (TWS3) - L27-16 (TWS3) | Always | Below 1 Ω |
| G2-1 (E2) - L27-9 (E2) | Always | Below 1 Ω |

Standard Resistance (Check for Short):

| Tester Condition | Condition | Specified Condition |
|--|-----------|-------------------------|
| G2-2 (TWS3) or L27-16 (TWS3) - Body ground | Always | 10 k Ω or higher |

Text in Illustration

| | |
|----|--|
| *1 | Front view of wire harness connector (to No. 3 Meter Circuit Plate) |
| *2 | Front view of wire harness connector (to Engine Coolant temperature sensor) |

(d) Reconnect the No. 3 meter circuit plate connector.

(e) Reconnect the engine coolant temperature sensor (for exhaust heat recirculation system) connector.

NG ▶ REPAIR OR REPLACE HARNESS OR CONNECTOR (ENGINE COOLANT TEMPERATURE SENSOR - COMBINATION METER)

OK



2.

INSPECT ENGINE COOLANT TEMPERATURE SENSOR (FOR EXHAUST HEAT RECIRCULATION SYSTEM)

(a) Inspect the engine coolant temperature sensor (for exhaust heat recirculation system) .

NG ▶ REPLACE ENGINE COOLANT TEMPERATURE SENSOR (FOR EXHAUST HEAT RECIRCULATION SYSTEM)

OK ▶ REPLACE NO. 3 METER CIRCUIT PLATE

COMPONENTS

ILLUSTRATION

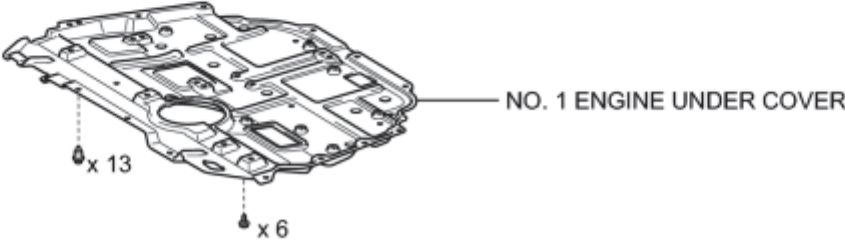
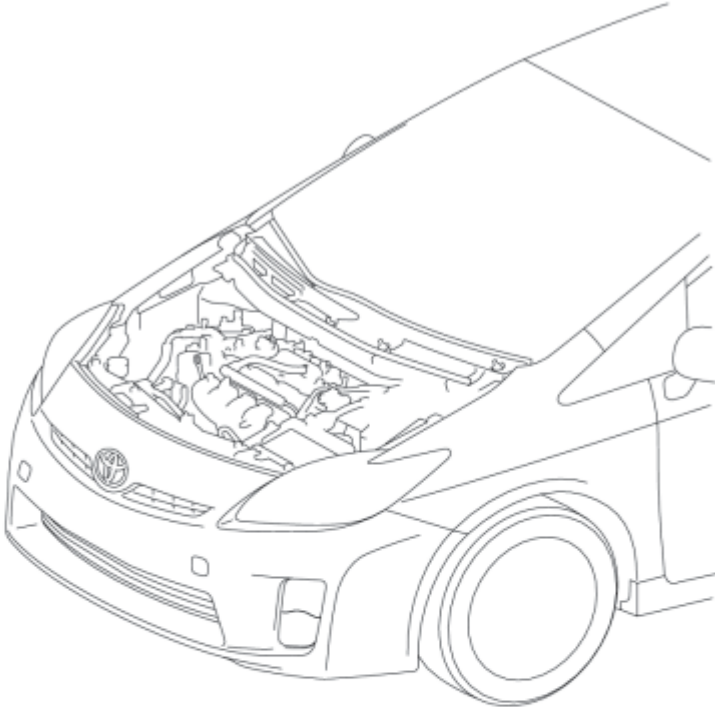

ILLUSTRATION

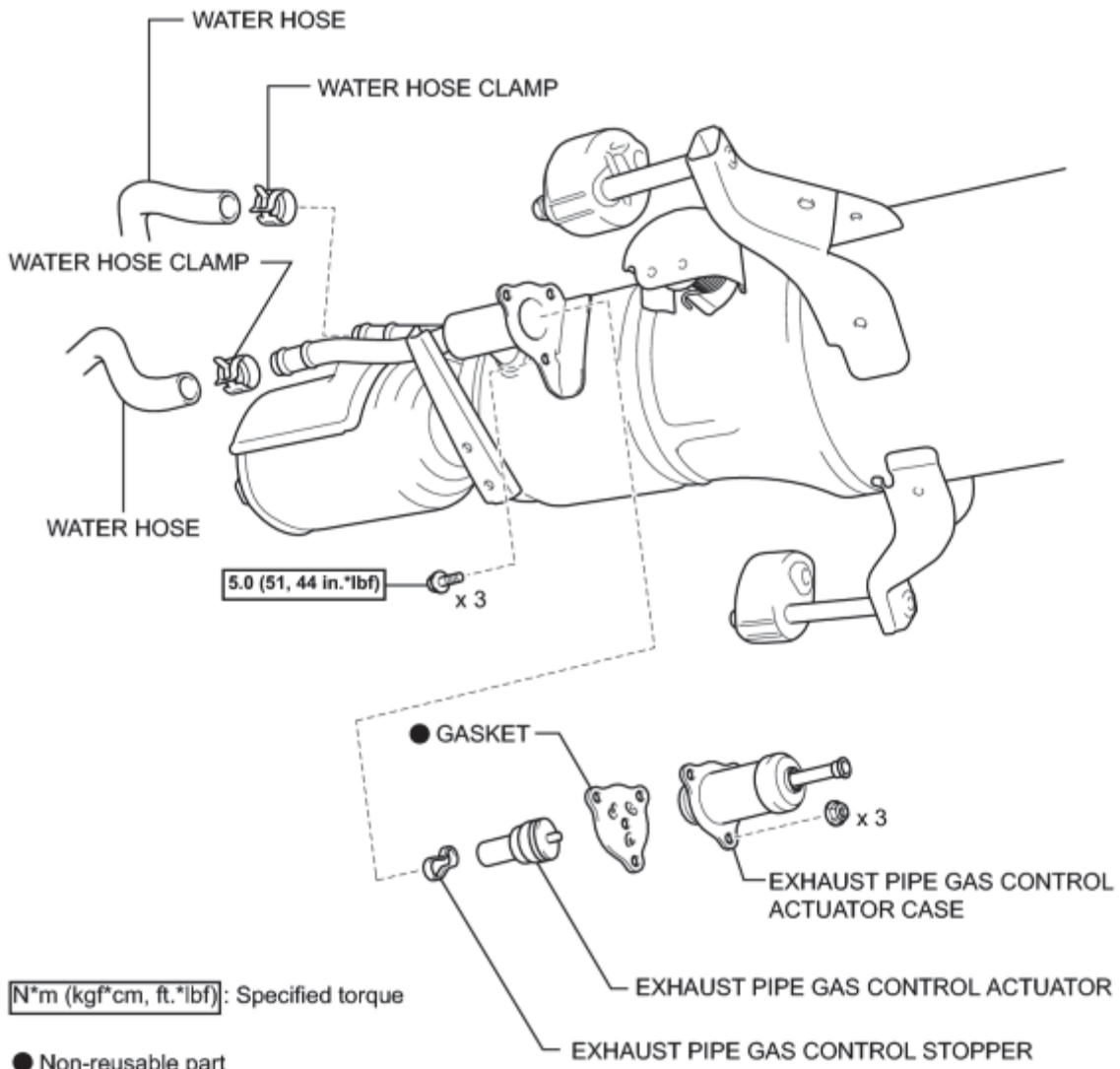

REMOVAL

1. REMOVE NO. 1 ENGINE UNDER COVER

2. DRAIN ENGINE COOLANT (for Engine)_INFO

3. REMOVE EXHAUST PIPE GAS CONTROL ACTUATOR

NOTICE:

When removing the exhaust pipe gas control actuator, use caution because coolant may spill out from the exhaust heat recirculation system.

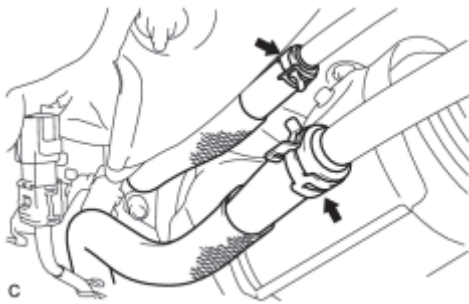

(a) Disconnect the 2 water hoses.

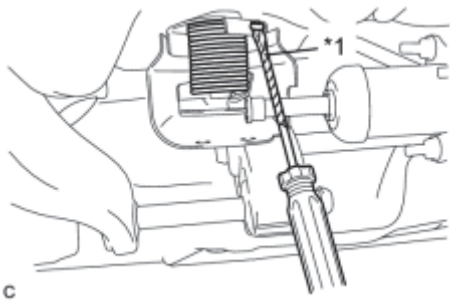

(b) Using a screwdriver with the tip taped, pry the portion indicated in the illustration to disengage the spring.

Text in Illustration

| | |
|----|-----------------|
| *1 | Protective Tape |
|----|-----------------|



(c) Remove the 3 bolts, 3 nuts, gasket and exhaust pipe gas control actuator case.

(d) While closing port A, apply compressed air to port B to remove the exhaust pipe gas control actuator shown in the illustration.

Text in Illustration

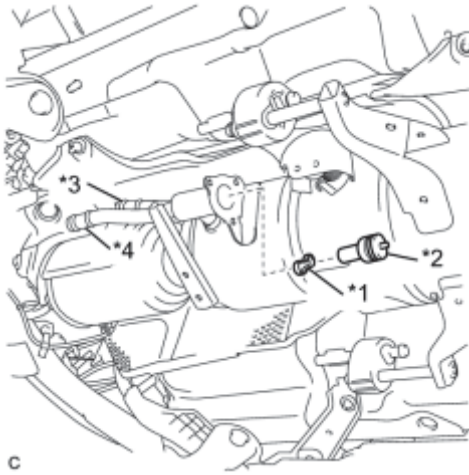

| | |
|----|-----------------------------------|
| *1 | Exhaust Pipe Gas Control Stopper |
| *2 | Exhaust Pipe Gas Control Actuator |
| *3 | Port A |
| *4 | Port B |

HINT:

Use a piece of cloth to catch the exhaust pipe gas control actuator.

INSTALLATION

1. INSTALL EXHAUST PIPE GAS CONTROL ACTUATOR

NOTICE:

When installing the water hose, ensure that the exhaust heat recirculation system is filled with coolant. Otherwise, the electric water pump may be damaged.

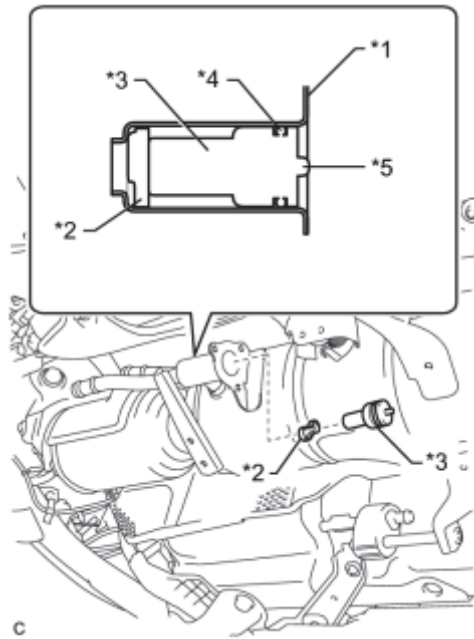

(a) Apply engine coolant to the O-ring.

Text in Illustration

| | |
|----|--|
| *1 | Exhaust Pipe Gas Control Actuator Case |
| *2 | Exhaust Pipe Gas Control Stopper |
| *3 | Exhaust Pipe Gas Control Actuator |
| *4 | O-ring |
| *5 | Piston |

(b) Install the exhaust pipe gas control actuator and exhaust pipe gas control stopper.

NOTICE:

- Be sure to install the exhaust pipe gas control stopper in the correct direction.
- Check that the O-ring is not deformed, cracked or swollen.
- Be sure to install the exhaust pipe gas control actuator until it touches the exhaust pipe gas control stopper.
- When installing the exhaust pipe gas control actuator, do not push on the piston.
- Make sure that the exhaust pipe gas control actuator and the exhaust pipe gas control stopper are free of oil.

(c) Install a new gasket and the exhaust pipe gas control actuator case with the 3 bolts and 3 nuts.

Text in Illustration

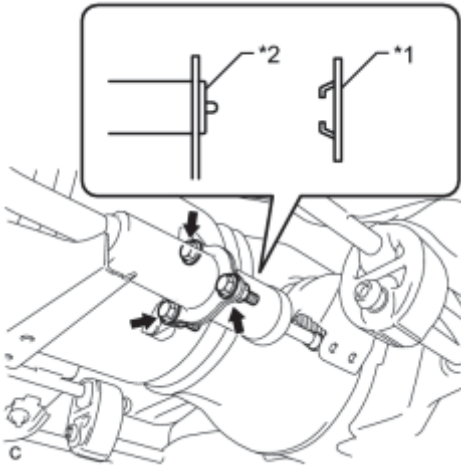

| | |
|----|-----------------------------------|
| *1 | Gasket |
| *2 | Exhaust Pipe Gas Control Actuator |

Torque: **5.0 N·m (51 kgf·cm, 44in·lbf)**

- Be sure to install a new gasket in the correct direction.
- Make sure that the exhaust pipe gas control actuator case and the new gasket are free of oil.

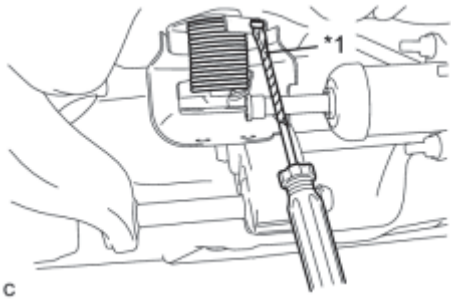

(d) Using a screwdriver with the tip taped, pry the portion indicated in the illustration to engage the spring.

Text in Illustration

| | |
|----|-----------------|
| *1 | Protective Tape |
|----|-----------------|

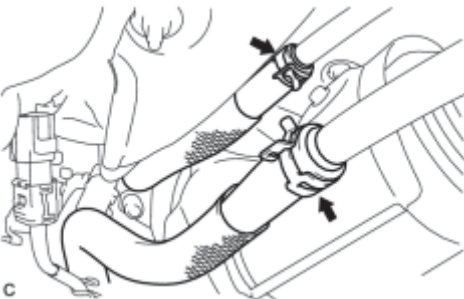

(e) Connect the 2 water hoses.

2. ADD ENGINE COOLANT (for Engine) INFO

3. INSPECT FOR COOLANT LEAK INFO

4. INSTALL NO. 1 ENGINE UNDER COVER