

**N\*m (kgf\*cm, ft.\*lbf)**: Specified torque

P

## ILLUSTRATION

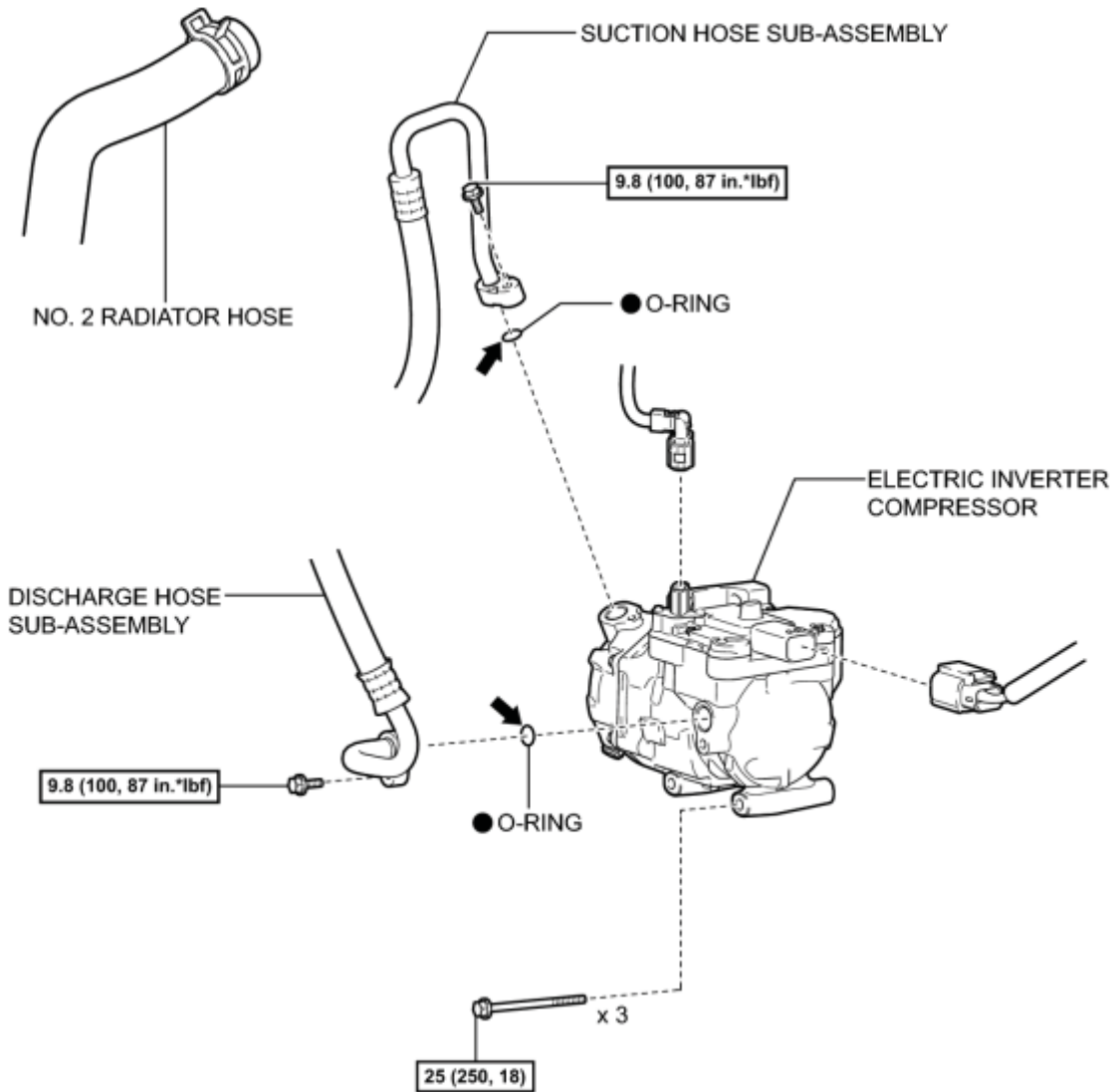

**N\*m (kgf\*cm, ft.\*lbf):** Specified torque

● Non-reusable part

← Compressor oil ND-OIL 11 or equivalent

P

# REMOVAL

## 1. PRECAUTION

INFO

## 2. RECOVER REFRIGERANT FROM REFRIGERATION SYSTEM\_

INFO

## 3. REMOVE REAR NO. 2 FLOOR BOARD (for Separate Type)\_

INFO

## 4. REMOVE REAR DECK FLOOR BOX\_

INFO

## 5. REMOVE REAR NO. 3 FLOOR BOARD\_

INFO

## 6. DISCONNECT CABLE FROM NEGATIVE BATTERY TERMINAL

### NOTICE:

When disconnecting the cable, some systems need to be initialized after the cable is reconnected

INFO

## 7. REMOVE SERVICE PLUG GRIP\_

INFO

## 8. CHECK TERMINAL VOLTAGE

(a) Remove the 9 bolts and inverter terminal cover.

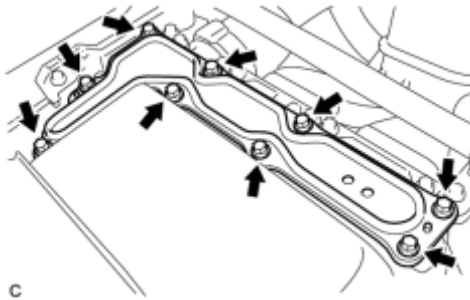

### CAUTION:

Wear insulating gloves.

### NOTICE:

Make sure to pull the inverter cover straight up, as a connector is connected to the bottom of the cover.

(b) Check the terminal voltage

INFO

### CAUTION:

Wear insulating gloves.

(c) Install the inverter cover with the 9 bolts to the inverter with converter assembly.

Torque: **8.0 N·m (82 kgf·cm, 71in·lbf)**

### CAUTION:

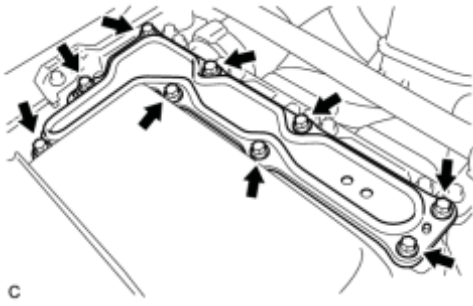

Wear insulating gloves.

- Make sure that the interlock is fully engaged.
- Do not allow any foreign objects or water drops to enter the inverter with converter assembly.

9. REMOVE INLET AIR CLEANER ASSEMBLY\_ INFO

10. REMOVE NO. 1 ENGINE UNDER COVER

11. DRAIN COOLANT (for Engine)\_ INFO

12. DISCONNECT NO. 2 RADIATOR HOSE

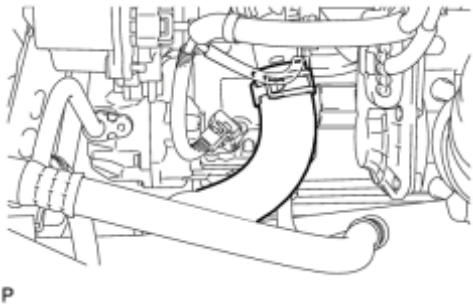

(a) Using pliers, grip the claws of the clip and slide the clip to remove the No. 2 radiator hose.

13. DISCONNECT DISCHARGE HOSE SUB-ASSEMBLY

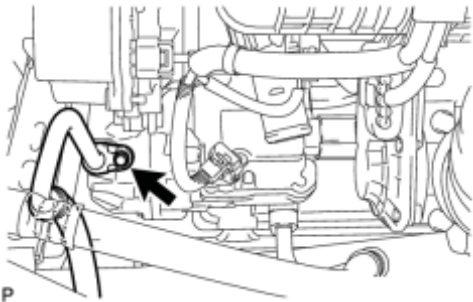

(a) Remove the bolt and disconnect the discharge hose sub-assembly from the electric inverter compressor.

(b) Remove the O-ring from the discharge hose sub-assembly.

NOTICE:

Seal the openings of the disconnected parts using vinyl tape to prevent entry of moisture and foreign matter.

14. DISCONNECT SUCTION HOSE SUB-ASSEMBLY

(a) Remove the bolt and disconnect the suction hose sub-assembly from the electric inverter compressor.

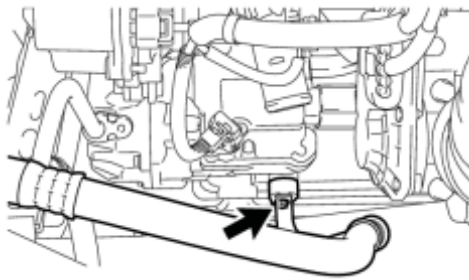

P

(b) Remove the O-ring from the suction hose sub-assembly.

NOTICE:

Seal the openings of the disconnected parts using vinyl tape to prevent entry of moisture and foreign matter.

### 15. REMOVE ELECTRIC INVERTER COMPRESSOR

(a) Release the green-colored lock and disconnect the connector <A> as shown in the illustration.

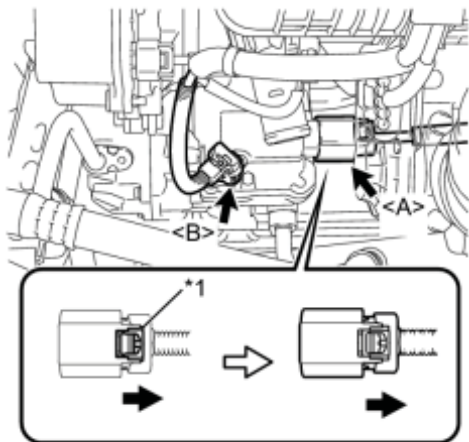

P

CAUTION:

Wear insulated gloves when performing the procedures.

NOTICE:

Insulate the connector by sealing it with tape.

### Text in Illustration

*1	Green-colored Lock
----	--------------------

(b) Disconnect the connector <B>.

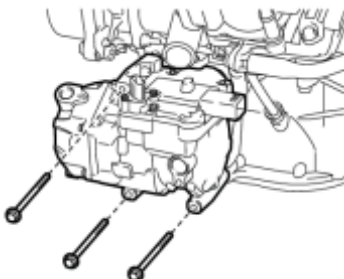

P

(c) Remove the 3 bolts and electric inverter compressor.

# INSPECTION

## 1. INSPECT COMPRESSOR WITH MOTOR ASSEMBLY

### CAUTION:

- Because the compressor has a high-voltage circuit, wear insulated gloves and pull out the service plug grip to cut off the high-voltage circuit before inspection.
- Do not touch the high-voltage connectors or terminals for 10 minutes after the service plug grip is removed.

### NOTICE:

Do not start the engine with the service plug grip removed because it may cause a malfunction.

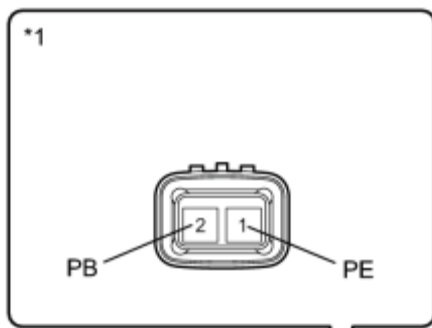

(a) Disconnect the compressor with motor assembly connector.

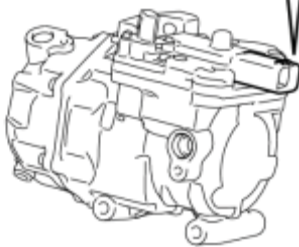

H

(b) Using a megohmmeter, measure the resistance according to the value(s) in the table below.

Standard Resistance:

Tester Connection	Condition	Specified Condition
E1-1 (PE) - Body ground	Always	2 MΩ or higher
E1-2 (PB) - Body ground	Always	2 MΩ or higher

### *Text in Illustration*

*1	Component without harness connected (Compressor with motor assembly)
----	---

If the resistance is not as specified, replace the compressor with motor assembly.



# INSTALLATION

## 1. ADJUST COMPRESSOR OIL

(a) When replacing the electric inverter compressor with a new one, gradually discharge the refrigerant gas from the service valve, and drain the following amount of oil from the new electric inverter compressor before installation.

Standard:

(Oil capacity inside the new electric inverter compressor: 130 to 145 cc (4.4 to 4.9 fl. oz.)) - (Remaining oil amount in the removed electric inverter compressor) = (Oil amount to be removed from the new compressor when replacing)

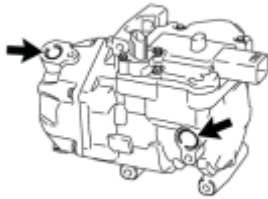

P

- When checking the compressor oil level, observe the precautions on the cooler removal/installation.
- If a new compressor and magnetic clutch are installed without removing some oil, there will be too much oil in the system due to the oil remaining in the pipes of the vehicle. Excessive oil in the system prevents heat exchange in the refrigeration cycle and causes refrigeration failure.
- If the amount of oil remaining in the old compressor and magnetic clutch is too small, check the A/C system for oil leaks.
- Be sure to use ND-OIL 11 or equivalent for compressor oil. If any compressor oil other than ND-OIL 11 is used, compressor motor insulation performance may decrease, resulting in a leakage of electric power.

## 2. INSTALL ELECTRIC INVERTER COMPRESSOR

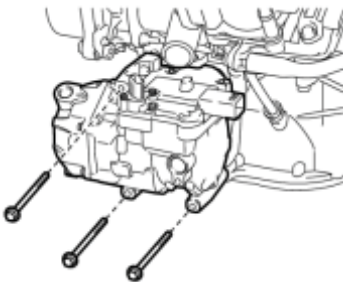

P

(a) Temporarily install the electric inverter compressor with the 3 bolts.

(b) Install the electric inverter compressor with the 3 bolts.

Torque: **25 N·m (250 kgf·cm, 18ft·lbf)**

NOTICE:

Tighten the bolts in the order shown in the illustration to install the



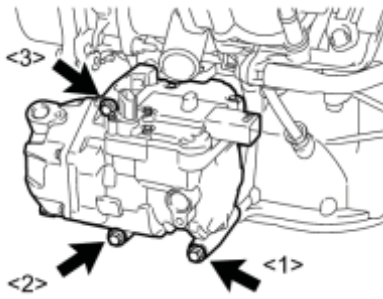

electric inverter compressor.

P

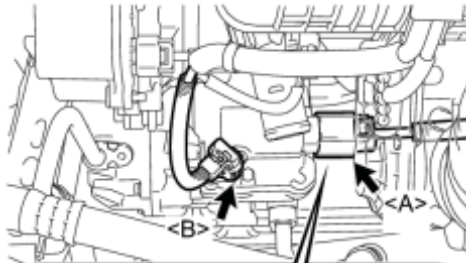

(c) Connect the connector <A> and lock the green-colored lock as shown in the illustration.

CAUTION:

Wear insulated gloves when performing the procedures.

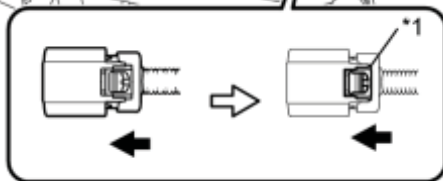

### Text in Illustration

*1	Green-colored Lock
----	--------------------

P

(d) Connect the connector <B>.

### 3. CONNECT SUCTION HOSE SUB-ASSEMBLY

(a) Remove the attached vinyl tape from the hose.

(b) Sufficiently apply compressor oil to a new O-ring and the fitting surface of the compressor and magnetic clutch.

Compressor oil:

ND-OIL 11 or equivalent

(c) Install the O-ring onto the suction hose sub-assembly.

NOTICE:

- Keep the O-ring and O-ring fitting surfaces free from dirt or any foreign objects.
- Do not use any compressor oil other than ND-OIL 11 or equivalent. If any compressor oil other than ND-OIL 11 or equivalent is used, compressor motor insulation performance may decrease, resulting in a leakage of electric power.

(d) Install the suction hose sub-assembly onto the compressor and magnetic clutch with the bolt.

Torque: **9.8 N·m (100 kgf·cm, 87in·lbf)**

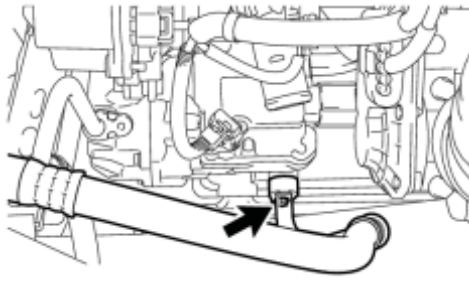

P

#### 4. CONNECT DISCHARGE HOSE SUB-ASSEMBLY

- (a) Remove the attached vinyl tape from the hose.
- (b) Sufficiently apply compressor oil to a new O-ring and the fitting surface of the compressor and magnetic clutch.

Compressor oil:

ND-OIL 11 or equivalent

- (c) Install the O-ring onto the discharge hose sub-assembly.

NOTICE:

- Keep the O-ring and O-ring fitting surfaces free from dirt or any foreign objects.
- Do not use any compressor oil other than ND-OIL 11 or equivalent. If any compressor oil other than ND-OIL 11 or equivalent is used, compressor motor insulation performance may decrease, resulting in a leakage of electric power.

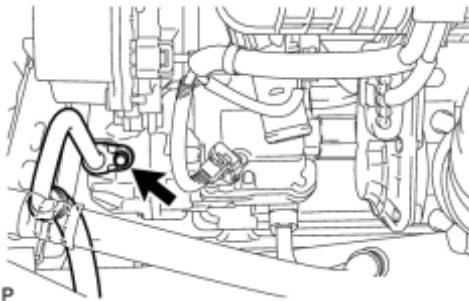

P

- (d) Install the discharge hose sub-assembly onto the compressor and magnetic clutch with the bolt.

**Torque: 9.8 N·m (100 kgf·cm, 87in·lbf)**

#### 5. CONNECT NO. 2 RADIATOR HOSE

- (a) Using pliers, grip the claws of the clip and slide the clip to install the No. 2 radiator hose.

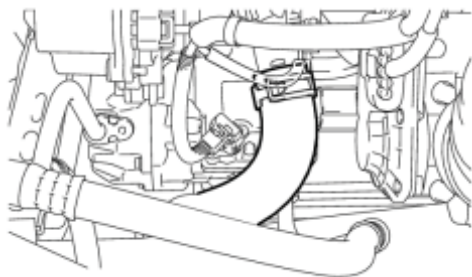

P

6. ADD COOLANT (for Engine)\_ **INFO**

7. INSPECT FOR COOLANT LEAK (for Engine)\_ **INFO**

8. INSTALL SERVICE PLUG GRIP\_ **INFO**

9. CONNECT CABLE TO NEGATIVE BATTERY TERMINAL

NOTICE:

When disconnecting the cable, some systems need to be initialized after the cable is reconnected **INFO**.

10. INSTALL REAR NO. 3 FLOOR BOARD\_ **INFO**

11. INSTALL REAR DECK FLOOR BOX\_ **INFO**

12. INSTALL REAR NO. 2 FLOOR BOARD (for Separate Type)\_ **INFO**

13. CHARGE WITH REFRIGERANT\_ **INFO**

14. WARM UP COMPRESSOR\_ **INFO**

15. INSPECT FOR REFRIGERANT LEAK\_ **INFO**

16. INSTALL NO. 1 ENGINE UNDER COVER

17. INSTALL INLET AIR CLEANER ASSEMBLY\_ **INFO**