

# ADJUSTMENT

## NOTICE:

If the wheel alignment has been adjusted, and if suspension or underbody components have been removed/installed or replaced, be sure to perform the following initialization procedure in order for the system to function normally:

- Perform zero point calibration of the yaw rate and acceleration sensor.

## 1. INSPECT TIRES

INFO

## 2. MEASURE VEHICLE HEIGHT

- Before inspecting the wheel alignment, adjust the vehicle height to the specified value.
- Be sure to perform measurement on a level surface.
- If it is necessary to go under the vehicle for measurement, confirm that the parking brake is applied and the vehicle is secured with chocks.
- Inspect while the vehicle is unloaded.

(a) Bounce the vehicle up and down at the corners to stabilize the suspension.

(b) Measure the vehicle height.

### Measurement points:

A: Ground clearance of front No. 1 lower suspension arm bushing set bolt center

B: Ground clearance of rear axle beam bushing set bolt center

C: Ground clearance of front wheel center

D: Ground clearance of rear wheel center

Vehicle Height (Unloaded Vehicle):

Tire Size	Front C - A	Rear D - B
195/65R15	108 mm (4.25 in.)	26 mm (1.02 in.)
	90 mm (3.54 in.)*	9 mm (0.354 in.)*
215/45R17	103 mm (4.06 in.)	21 mm (0.827 in.)

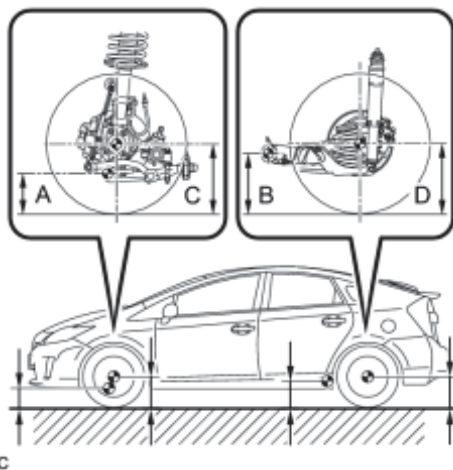

\* For vehicle height for Rough Road Package.

### 3. INSPECT CAMBER, CASTER AND STEERING AXIS INCLINATION

#### NOTICE:

Inspect while the vehicle is unloaded.

(a) Install a camber-caster-kingpin gauge and place the front wheels on the center of a wheel alignment tester.

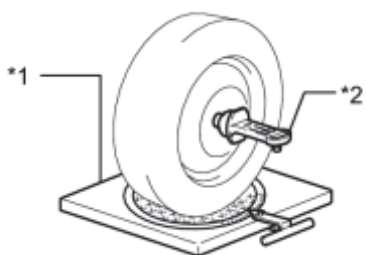

#### Text in Illustration

*1	Wheel Alignment Tester
*2	Gauge

(b) Inspect the camber, caster and steering axis inclination.

Camber (Unloaded Vehicle):

Tire Size	Camber Inclination	Right-left Difference
195/65R15	-0°13' +/- 45' (-0.22° +/- 0.75°)	45' (0.75°) or less
	-0°07' +/- 45' (-0.12° +/- 0.75°)*	
215/45R17	-0°12' +/- 45' (-0.20° +/- 0.75°)	

\* For vehicle height for Rough Road Package.

Caster (Unloaded Vehicle):

Tire Size	Caster Inclination	Right-left Difference
195/65R15	5°53' +/- 45' (5.88° +/- 0.75°)	45' (0.75°) or less
	5°40' +/- 45' (5.67° +/- 0.75°)*	
215/45R17	5°50' +/- 45' (5.83° +/- 0.75°)	

\* For vehicle height for Rough Road Package.

Steering Axis Inclination (Unloaded Vehicle):

Tire Size	Steering Axis Inclination
195/65R15	12°16' (12.27°)
	11°52' (11.87°)*

Tire Size	Steering Axis Inclination
215/45R17	12°10' (12.17°)

\* For vehicle height for Rough Road Package.

#### 4. ADJUST CAMBER

NOTICE:

Inspect toe-in after the camber has been adjusted.

(a) Remove the front wheel.

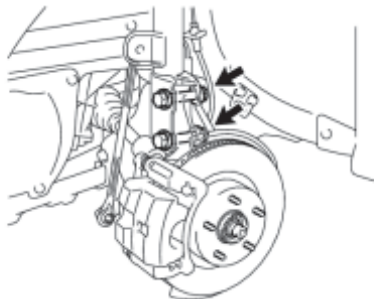

c

(b) Loosen the 2 nuts.

NOTICE:

Keep the bolts inserted.

(c) Clean the installation surfaces of the front shock absorber and the steering knuckle.

(d) Temporarily install the 2 nuts. (Step A)

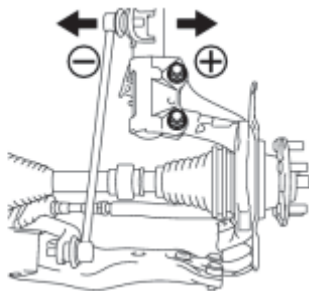

P

(e) Fully push or pull the front axle hub in the direction of the required adjustment. (Step B)

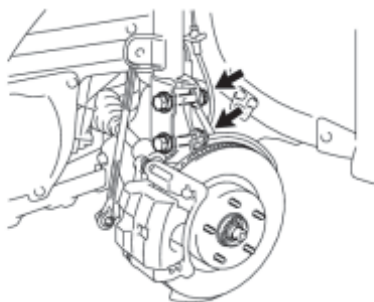

c

(f) Tighten the nuts.

Torque: **240 N·m (2447 kgf·cm, 177ft·lbf)**

NOTICE:

Keep the bolts from rotating when tightening the nuts.

(g) Install the front wheel.

Torque: **103 N·m (1050 kgf·cm, 76ft·lbf)**

2010 Toyota Prius

Repair Manual

(h) Check the camber.

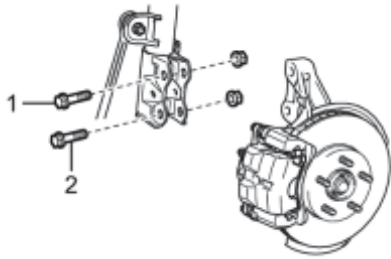

c

If the measured value is not within the specification, calculate the required adjustment amount using the formula below.

Camber adjustment amount = center of the specified range - measured value















Check the combination of the installed bolts. Select appropriate bolts from the tables below to adjust the camber to the specified values.

HINT:

Try to adjust the camber to the center of the specified values.

<b>Move the axle hub toward (+) in step B</b>	<b>Move the axle hub toward (-) in step B</b>
Refer to table (1) (Move the axle hub toward the positive side)	Refer to table (2) (Move the axle hub toward the negative side)

Table (1) (Move the axle hub toward the positive side)

Installed Bolt	1	 90105-17019	 90105-17019	 90105-17019	 90105-17019	 90105-17016	 90105-17017	 90105-17018
	2	 90105-17019	 90105-17016	 90105-17017	 90105-17018	 90105-17018	 90105-17018	 90105-17018
Adjusting Value	-1°30' to -1°15' (-1.50° to -1.25°)							G
	-1°15' to -1°00' (-1.25° to -1°)						G	A
	-1°00' to -0°45' (-1° to -0.75°)					G	A	B
	-0°45' to -0°30' (-0.75° to -0.5°)				G	A	B	C
	-0°30' to -0°15' (-0.5° to -0.25°)			G	A	B	C	D
	-0°15' to 0° (-0.25° to 0°)		G	A	B	C	D	E
	0° to 0°15' (0° to 0.25°)	A	B	C	D	E	F	
	0°15' to 0°30' (0.25° to 0.5°)	B	C	D	E	F		
	0°30' to 0°45' (0.5° to 0.75°)	C	D	E	F			
	0°45' to 1°00' (0.75° to 1°)	D	E	F				
	1°00' to 1°15' (1° to 1.25°)	E	F					
	1°15' to 1°30' (1.25° to 1.5°)	F						

Selected Bolt Combination











































	A	B	C	D	E	F	G
1	 90105-17019	 90105-17019	 90105-17019	 90105-17016	 90105-17017	 90105-17018	 90105-17019
2	 90105-17016	 90105-17017	 90105-17018	 90105-17018	 90105-17018	 90105-17018	 90105-17019

Table (2) (Move the axle hub toward the negative side)

Installed Bolt	1	 90105-17019	 90105-17019	 90105-17019	 90105-17019	 90105-17016	 90105-17017	 90105-17018
	2	 90105-17019	 90105-17016	 90105-17017	 90105-17018	 90105-17018	 90105-17018	 90105-17018
Adjusting Value	-1°30' to -1°15' (-1.50° to -1.25°)	F						
	-1°15' to -1°00' (-1.25° to -1°)	E	F					
	-1°00' to -0°45' (-1° to -0.75°)	D	E	F				
	-0°45' to -0°30' (-0.75° to -0.5°)	C	D	E	F			
	-0°30' to -0°15' (-0.5° to -0.25°)	B	C	D	E	F		
	-0°15' to 0° (-0.25° to 0°)	A	B	C	D	E	F	
	0° to 0°15' (0° to 0.25°)		G	A	B	C	D	E
	0°15' to 0°30' (0.25° to 0.5°)			G	A	B	C	D
	0°30' to 0°45' (0.5° to 0.75°)				G	A	B	C
	0°45' to 1°00' (0.75° to 1°)					G	A	B
	1°00' to 1°15' (1° to 1.25°)						G	A
	1°15' to 1°30' (1.25° to 1.5°)							G

Selected Bolt Combination

	A	B	C	D	E	F	G
1	 90105-17019	 90105-17019	 90105-17019	 90105-17016	 90105-17017	 90105-17018	 90105-17019
2	 90105-17016	 90105-17017	 90105-17018	 90105-17018	 90105-17018	 90105-17018	 90105-17019

NOTICE:

Replace the nut with a new one when replacing the bolt.

The body and suspension may be damaged if the camber is not correctly adjusted according to the tables above.

(i) Repeat the steps mentioned above. In Step A, replace 1 or 2 selected bolts.

HINT:

Replace one bolt at a time when replacing both bolts.

## 5. INSPECT TOE-IN

NOTICE:

Inspect while the vehicle is unloaded.

(a) Bounce the vehicle up and down at the corners to stabilize the suspension.

(b) Release the parking brake and move the shift lever to N.

(c) Push the vehicle straight ahead approximately 5 m (16.4 ft.). (Step C)

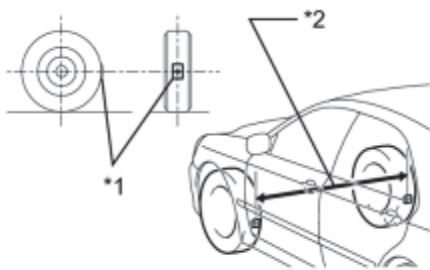

(d) Put tread center marks on the rearmost points of the front wheels and measure the distance between the marks (dimension B).

### Text in Illustration

*1	Tread Center Mark
*2	Dimension B

(e) Slowly push the vehicle straight ahead to cause the front wheels to rotate 180° using the front tire valve as a reference point.

HINT:

Do not allow the wheels to rotate more than 180°. If the wheels rotate more than 180°, perform the procedure from Step C again.

(f) Measure the distance between the tread center marks on the front side of the wheels (dimension A).

### Text in Illustration

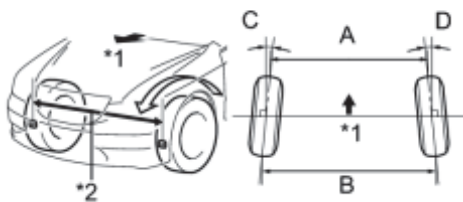

*1	Front of the Vehicle
*2	Dimension A

### To-in (Unloaded Vehicle)

Specified Condition
C + D: 0°12' +/- 0°12' (0.20° +/- 0.20°)
C + D: 0°18' +/- 0°12' (0.30° +/- 0.20°)*
B - A: 2.0 +/- 2.0 mm (0.0787 +/- 0.0787 in.)
B - A: 3.0 +/- 2.0 mm (0.118 +/- 0.0787 in.)*

\* For vehicle height for Rough Road Package.

HINT:

Measure "B - A" only when "C + D" cannot be measured.

If the toe-in is not within the specified range, adjust it at the rack ends.

## 6. ADJUST TOE-IN

(a) Make sure that the thread length of the right and left rack ends are approximately the same.

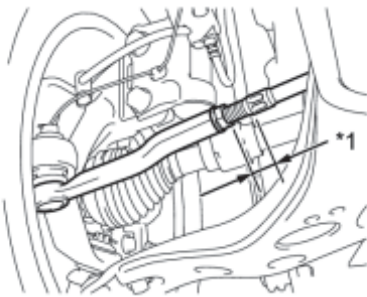

### Text in Illustration

*1	Thread Length
----	---------------

Standard difference:

1.5 mm (0.0591 in.) or less

(b) Remove the boot clips.

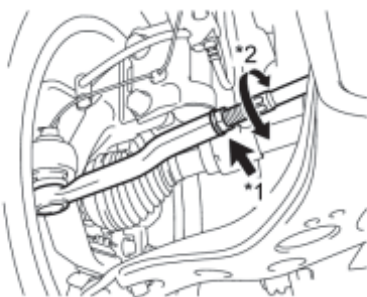

(c) Loosen the tie rod end lock nuts.

### Text in Illustration

*1	Loosen
*2	Turn

(d) Adjust the rack ends if the difference in thread length between the right and left rack ends is not within the specified range.

(1) Extend the shorter rack end if the measured toe-in deviates toward the outer-side.

(2) Shorten the longer rack end if the measured toe-in deviates toward the inner-side.



(e) Turn the right and left rack ends by an equal amount to adjust the toe-in to the center value.

(f) Make sure that the thread lengths of the right and left rack ends are the same.

(g) Tighten the tie rod end lock nuts.

Torque: **74 N·m (755 kgf·cm, 55ft·lbf)**

(h) Place the boots on the seats and install the clips.

HINT:

Make sure that the boots are not twisted.

## 7. INSPECT WHEEL ANGLE

### Text in Illustration

*1	Front of the Vehicle
*2	Inside
*3	Outside

(a) Put tread center marks on the rearmost points of a turning radius gauge.

(b) Turn the steering wheel to the left and right full lock positions, and measure the turning angle.

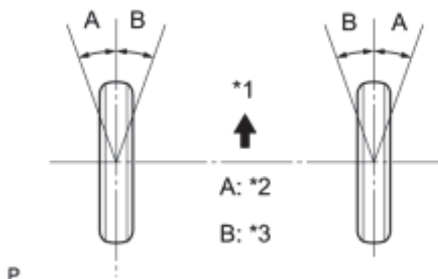

NOTICE:

Inspect while the vehicle is unloaded.

Wheel Angle (Unloaded Vehicle):

Tire Size	Inside Wheel	Outside Wheel Reference
195/65R15	40°50' +/- 2° (40.83° +/- 2°)	33°50' (33.83°)
	37°42' +/- 2° (37.70° +/- 2°)*	32°13' (32.22°)*
215/45R17	37°27' +/- 2° (37.45° +/- 2°)	31°56' (31.93°)

\* For vehicle height for Rough Road Package.

If the angles are not as specified, check and adjust the right and left rack end lengths.

## 8. PLACE FRONT WHEELS FACING STRAIGHT AHEAD

## 9. PERFORM YAW RATE AND ACCELERATION SENSOR CALIBRATION

INFO .

## 10. PERFORM INITIALIZATION (w/ Height Control Sensor)

### NOTICE:

Some systems need to be initialized after the wheel alignment is adjusted INFO .

# INSPECTION

## NOTICE:

If the wheel alignment has been adjusted, and if suspension or underbody components have been removed/installed or replaced, be sure to perform the following initialization procedure in order for the system to function normally:

- Perform zero point calibration of the yaw rate and acceleration sensor and test mode inspection.

## 1. INSPECT TIRES

INFO

## 2. MEASURE VEHICLE HEIGHT\_

INFO

## 3. INSPECT CAMBER

### NOTICE:

Inspect while the vehicle is unloaded.

- (a) Install a camber-caster-kingpin gauge.
- (b) Inspect the camber.

Camber (Unloaded Vehicle):

Tire Size	Camber Inclination	Right-left Difference
195/65R15	-1°29' +/- 30' (-1.48° +/- 0.50°)	30' (0.50°) or less
215/45R17	-1°28' +/- 30' (-1.47° +/- 0.50°)	

### HINT:

Camber is not adjustable. If the measurement is not within the specified range, inspect the suspension parts for damage and/or wear, and replace them if necessary.

## 4. INSPECT TOE-IN

### NOTICE:

Inspect while the vehicle is unloaded.

- (a) Bounce the vehicle up and down at the corners to stabilize the suspension.
- (b) Release the parking brake and move the shift lever to N.
- (c) Push the vehicle straight ahead approximately 5 m (16.4 ft.). (Step A)

(d) Put tread center marks on the rearmost points of the rear wheels and measure the distance between the marks (dimension B).

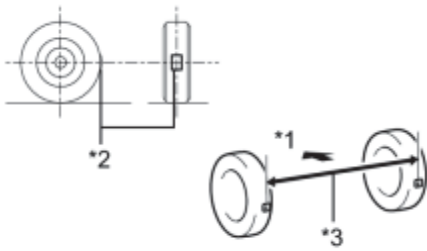

### Text in Illustration

*1	Front of the Vehicle
*2	Tread Center Mark
*3	Dimension B

(e) Slowly push the vehicle straight ahead to cause the rear wheels to rotate 180° using the rear tire valve as a reference point.

HINT:

Do not allow the wheels to rotate more than 180°. If the wheels rotate more than 180°, perform the procedure from Step A again.

(f) Measure the distance between the tread center marks on the front side of the wheels (dimension A).

### Text in Illustration

*1	Front of the Vehicle
*2	Dimension A

Toe-in (Unloaded Vehicle):

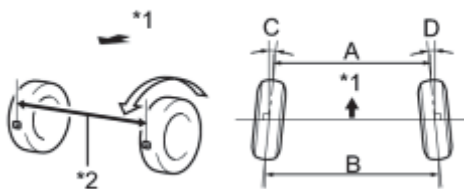

Tire Size	Specified Condition	Right-left Difference
195/65R15	C + D: 0°17' +/- 18' ( 0.29° +/- 0.30°)	45' (0.75°) or less
	C + D: 0°10' +/- 18' ( 0.17° +/- 0.30°)*	
	B - A: 2.9 +/- 3 mm (0.114 +/- 0.118 in.)	-
B - A: 1.7 +/- 3 mm (0.0669 +/- 0.118 in.)*		
215/45R17	C + D: 0°15' +/- 18' ( 0.25° +/- 0.30°)	45' (0.75°) or less
	B - A: 2.5 +/- 3 mm (0.0984 +/- 0.118 in.)	-

\* For vehicle height for Rough Road Package.

HINT:

Measure "B - A" only when "C + D" cannot be measured.

If the toe-in is not within the specified range, inspect the suspension parts and replace them if necessary.