

w/ Floor Under Cover:

REAR FLOOR STEP UNDER COVER SUB-ASSEMBLY

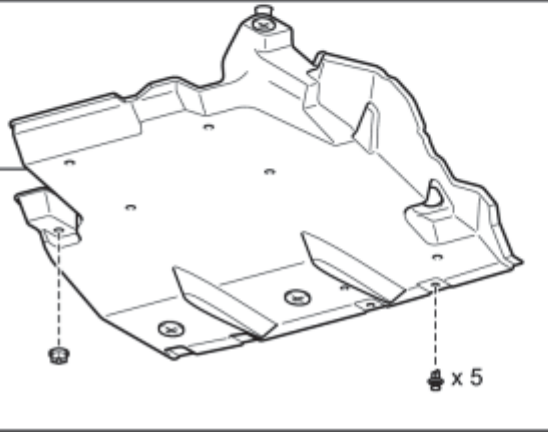

N*m (kgf*cm, ft.*lbf): Specified torque

REMOVAL

1. REMOVE REAR NO. 2 FLOOR BOARD (for Separate Type) INFO

2. REMOVE REAR DECK FLOOR BOX INFO

3. REMOVE REAR NO. 3 FLOOR BOARD INFO

4. DISCONNECT CABLE FROM NEGATIVE BATTERY TERMINAL

NOTICE:

When disconnecting the cable, some systems need to be initialized after the cable is reconnected INFO.

5. REMOVE REAR FLOOR STEP UNDER COVER SUB-ASSEMBLY (w/ Floor Under Cover)

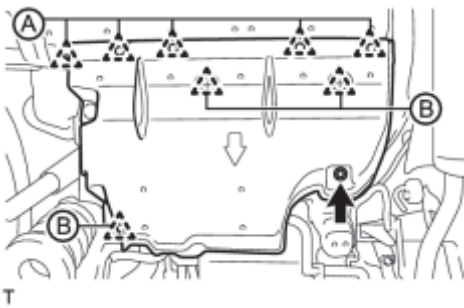

(a) Remove the 5 clips (A) and nut.

(b) Disconnect the 3 clips (B) and remove the rear floor step under cover sub-assembly.

6. REMOVE CHARCOAL CANISTER ASSEMBLY

(a) Using a screwdriver, pry up the retainer.

HINT:

Do not remove the retainer.

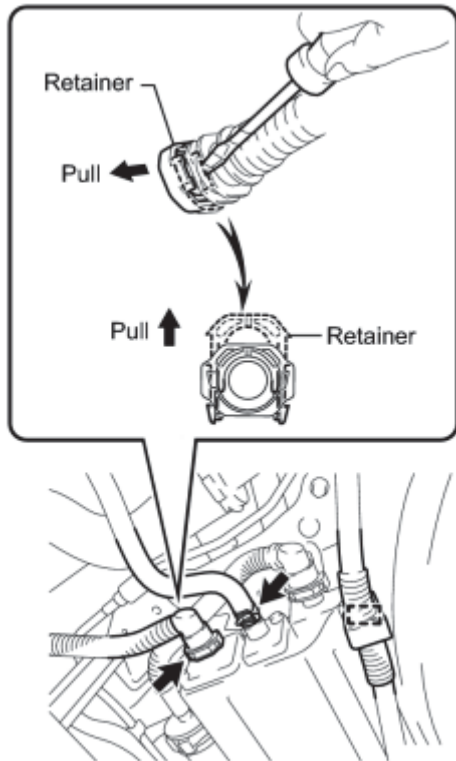

P

(b) Disconnect the tube clamp, purge line hose and vent line tube.

NOTICE:

- Remove any dirt or foreign matter on the vent line tube connector before performing this work.

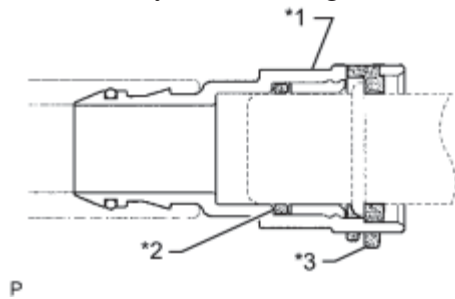

P

Text in Illustration

*1	Vent Line Tube Connector
*2	O-ring
*3	Retainer

- Do not allow any scratches or foreign matter on the parts when disconnecting them as the vent line tube connector has an O-ring that seals the pipe.
- Perform this work by hand. Do not use any tools.
- Do not forcibly bend, twist or turn the nylon tube.
- Protect the disconnected part by covering it with a plastic bag after disconnecting the vent line tube.
- If the vent line tube connector and pipe are stuck, push and pull to release them.

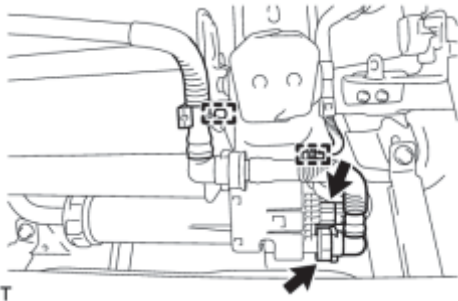

(c) Disconnect the tube clamp, wire harness clamp and connector air inlet line tube.

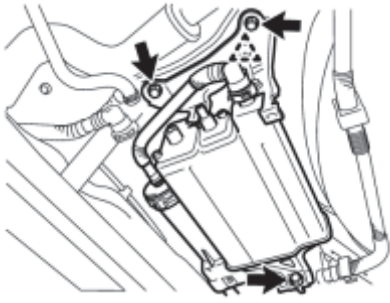

(d) Remove the 3 bolts, clip and charcoal canister assembly.

INSPECTION

1. INSPECT CHARCOAL CANISTER ASSEMBLY

(a) Visually check the charcoal canister assembly.

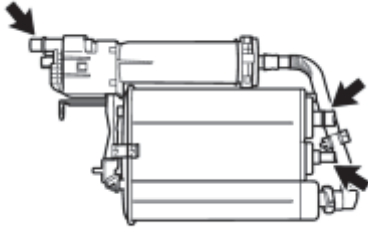

T

(1) Visually check the charcoal canister for cracks or damage.

If cracks or damage are found, replace the charcoal canister assembly.

(b) Check canister operation.

(1) With the purge port closed, blow 5 kPa (0.1 kgf/cm², 0.7 psi) of air into the vent port, and check that air flows from the air inlet port.

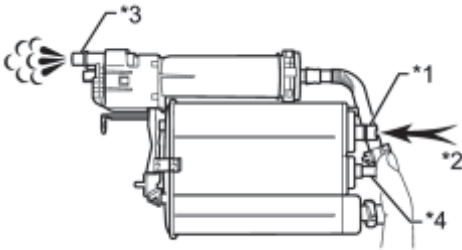

T

Text in Illustration

*1	Vent Port
*2	Air
*3	Air Inlet Port
*4	Purge Port

If the result is not as specified, replace the charcoal canister assembly.

(2) With the vent port closed, blow 5 kPa (0.1 kgf/cm², 0.7 psi) of air into the air inlet port, and check that air flows from the purge port.

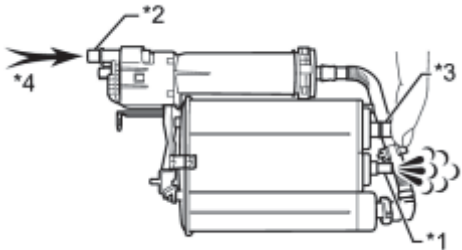

T

Text in Illustration

*1	Purge Port
*2	Air Inlet Port
*3	Vent Port
*4	Air

If the result is not as specified, replace the charcoal canister assembly.

(c) Check for air leaks.

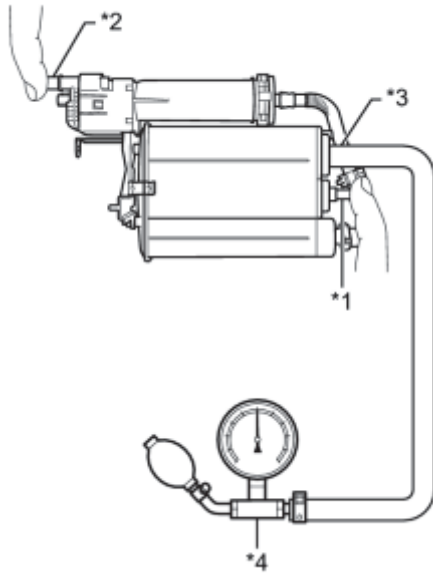

(1) Connect a pressure gauge to the vent port of the charcoal canister.

Text in Illustration

*1	Purge Port
*2	Air Inlet Port
*3	Vent Port
*4	Pressure Gauge

T

(2) With the purge port and the air inlet port closed, apply 20 kPa (150 mmHg, 5.91 in.Hg) of pressurized air into the vent port, then confirm that pressure is retained for 1 minute.

If the result is not as specified, replace the charcoal canister assembly.

(d) Check the leak detection pump.

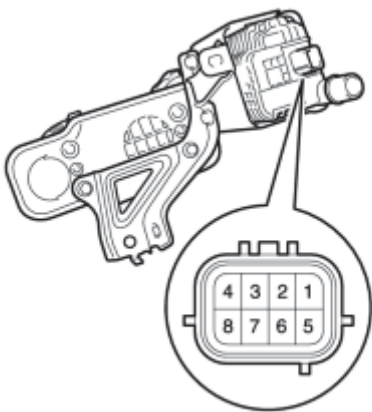

(1) Connect a positive (+) lead of the battery to terminal 5 and a negative (-) lead to terminal 1.

T

(2) Check that a clicking sound is heard from the leak detection pump.

If the result is not as specified, replace the charcoal canister assembly.

INSTALLATION

1. INSTALL CHARCOAL CANISTER ASSEMBLY

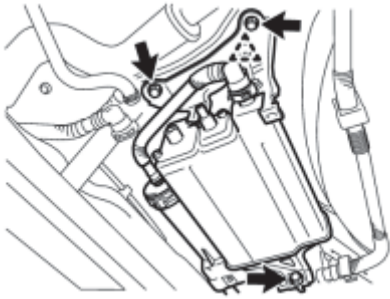

(a) Install the charcoal canister assembly with the 3 bolts and clip.

Torque: **19 N·m (194 kgf·cm, 14ft·lbf)**

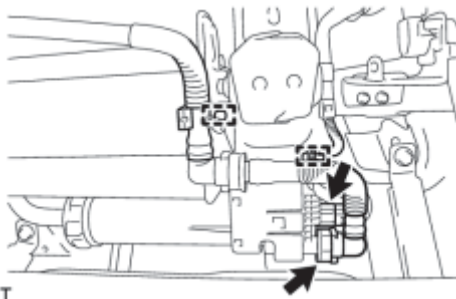

(b) Connect the air inlet line tube, connector, tube clamp and wire harness clamp.

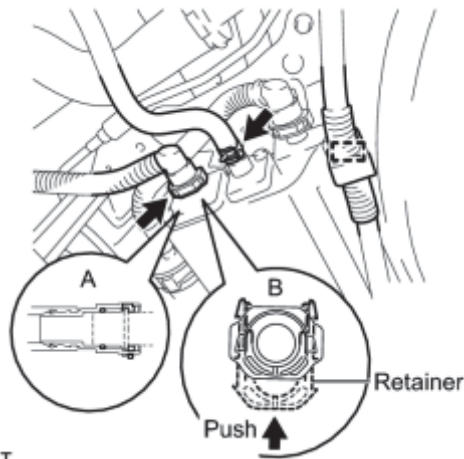

(c) Connect the vent line tube.

(1) Connect the pipe to the fuel tube connector, as shown in A in the illustration. Then push up the retainer to lock the claws, as shown in B in the illustration.

- Check that there are no scratches or foreign matter around the connected parts of the vent line tube connector and pipe before performing this work.
- After connecting the vent line tube, check that the vent line tube is securely connected by pulling the vent line tube connector and pipe.

(d) Connect the purge line hose and tube clamp.

2. INSTALL REAR FLOOR STEP UNDER COVER SUB-ASSEMBLY (w/ Floor Under Cover)

(a) Connect the 3 clips (B).

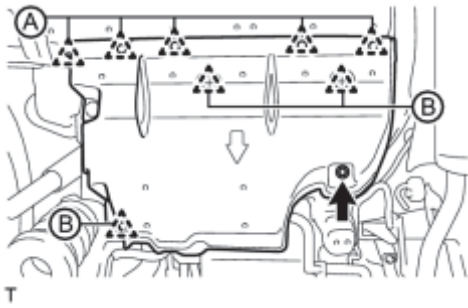

(b) Install the rear floor step under cover sub-assembly with the nut and 5 clips (A).

3. CONNECT CABLE TO NEGATIVE BATTERY TERMINAL

NOTICE:

When disconnecting the cable, some systems need to be initialized after the cable is reconnected INFO.

4. INSTALL REAR NO. 3 FLOOR BOARD INFO

5. INSTALL REAR DECK FLOOR BOX INFO

6. INSTALL REAR NO. 2 FLOOR BOARD (for Separate Type) INFO