

COMPONENTS

ILLUSTRATION

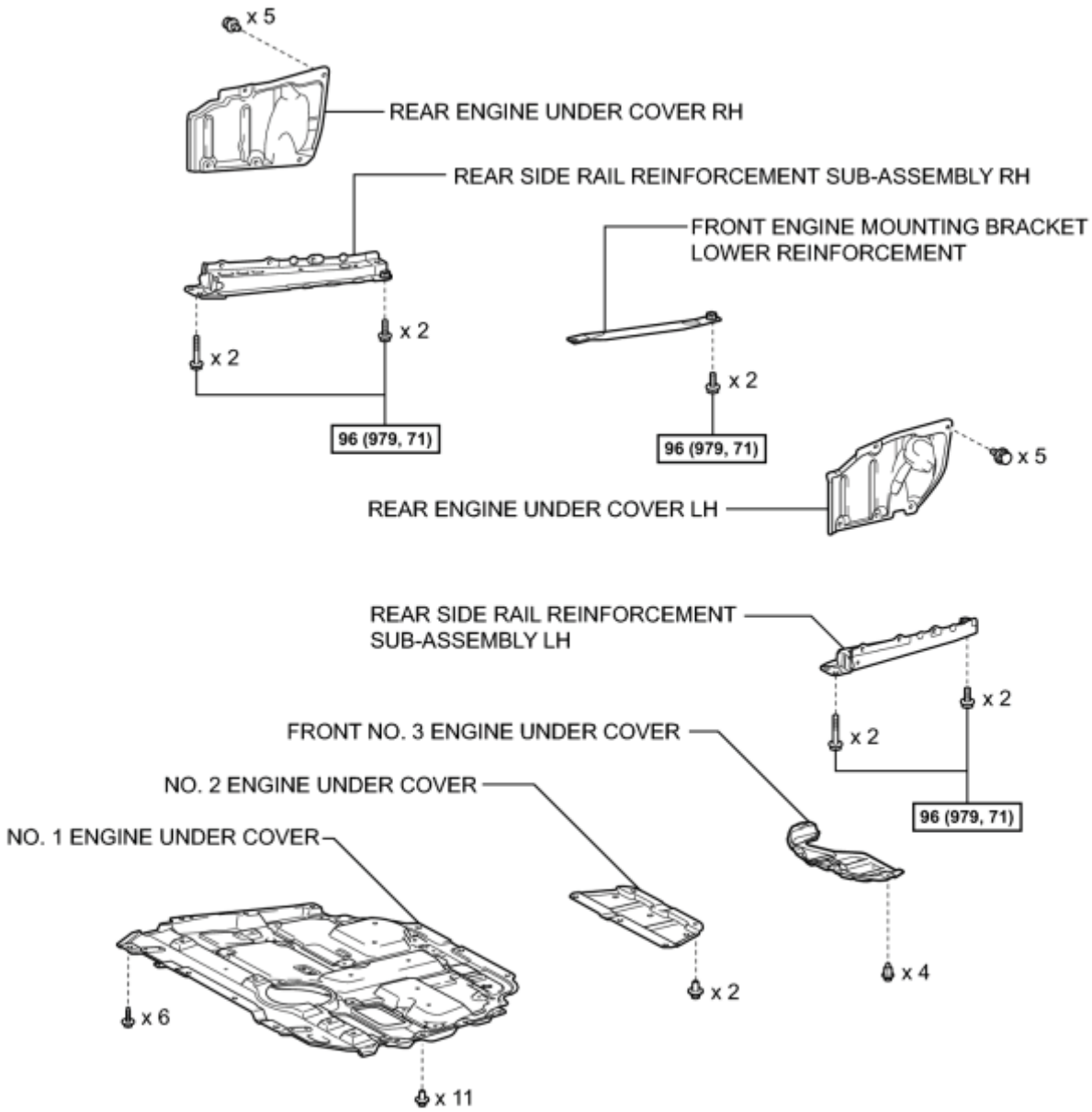

N*m (kgf*cm, ft.*lbf) : Specified torque

ILLUSTRATION

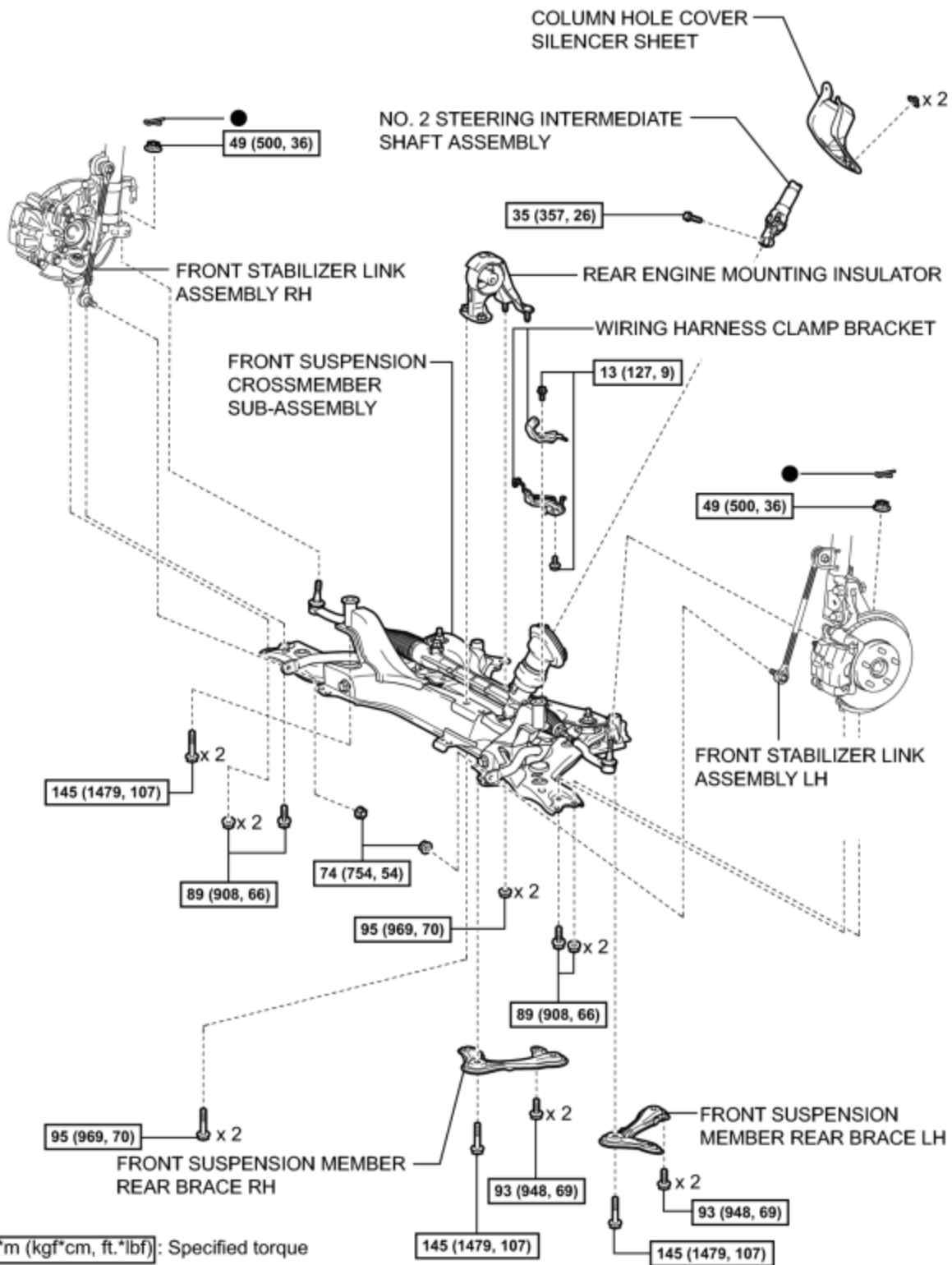

[N*m (kgf*cm, ft.*lbf)]: Specified torque

● Non-reusable part

ILLUSTRATION

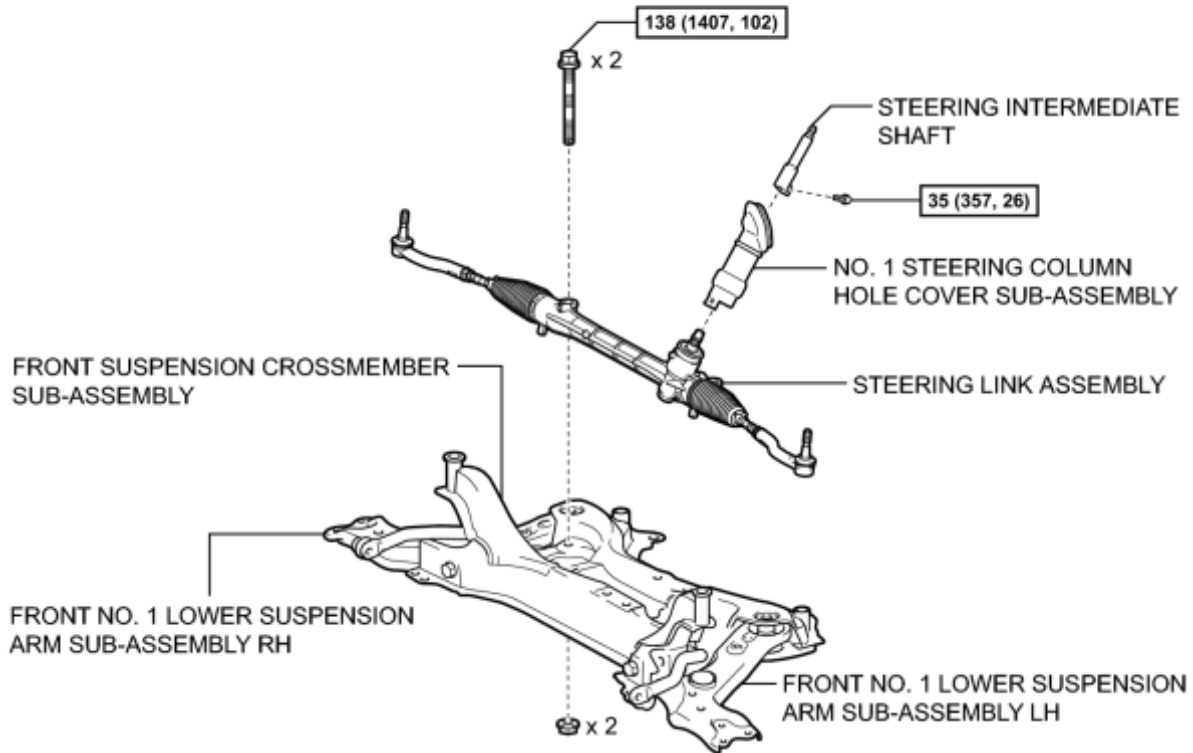

N*m (kgf*cm, ft.*lbf) : Specified torque

ILLUSTRATION

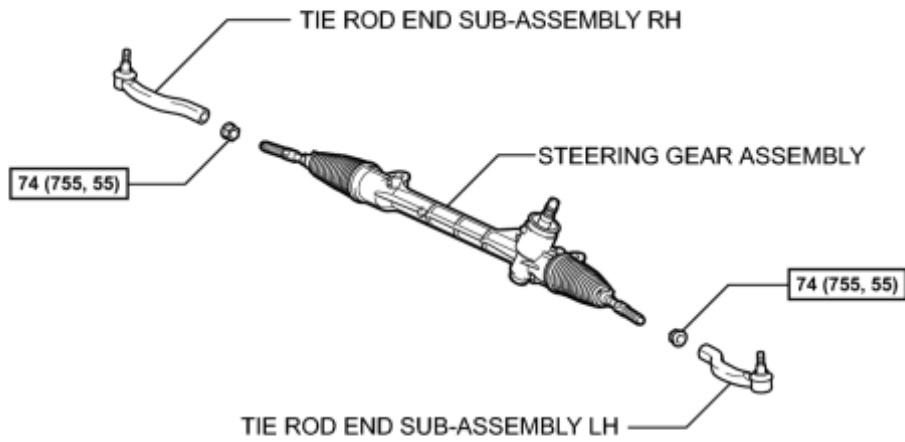

N*m (kgf*cm, ft.*lbf) : Specified torque

ILLUSTRATION

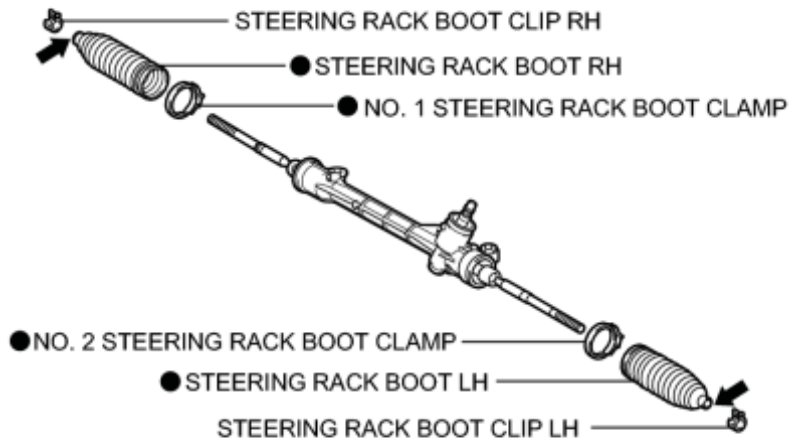

● Non-reusable part

← Lithium soap base glycol grease

c

REMOVAL

1. PLACE FRONT WHEELS FACING STRAIGHT AHEAD
2. SECURE STEERING WHEEL

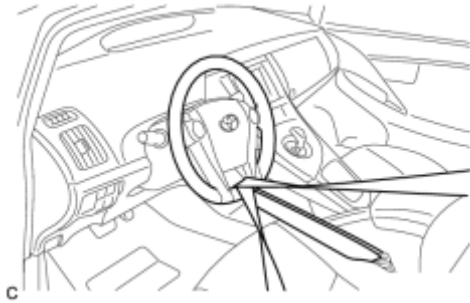

(a) Secure the steering wheel with the seat belt in order to prevent rotation.

HINT:

This operation is useful to prevent damage to the spiral cable.

3. REMOVE COLUMN HOLE COVER SILENCER SHEET INFO
4. SEPARATE NO. 2 STEERING INTERMEDIATE SHAFT ASSEMBLY INFO
5. SEPARATE NO. 1 STEERING COLUMN HOLE COVER SUB-ASSEMBLY

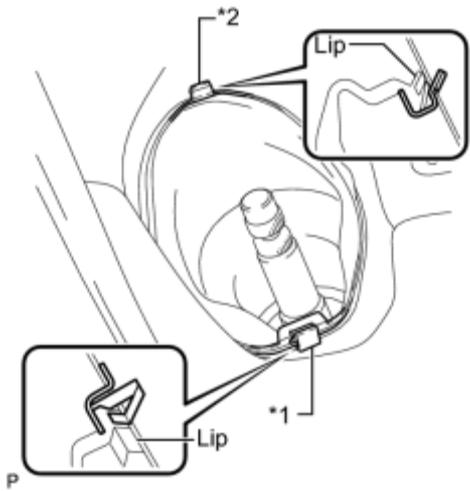

(a) Remove clip A, detach clip B from the body and disconnect the No. 1 steering column hole cover sub-assembly.

Text in Illustration

*1	Clip A
*2	Clip B

NOTICE:

Do not damage clips A and B.

6. REMOVE FRONT WHEELS
7. REMOVE NO. 1 ENGINE UNDER COVER
8. REMOVE NO. 2 ENGINE UNDER COVER
9. REMOVE FRONT NO. 3 ENGINE UNDER COVER
10. REMOVE REAR ENGINE UNDER COVER LH

11. REMOVE REAR ENGINE UNDER COVER RH

HINT:

Perform the same procedure as for the LH side.

12. SEPARATE FRONT STABILIZER LINK ASSEMBLY LH NFC

13. SEPARATE FRONT STABILIZER LINK ASSEMBLY RH

HINT:

Perform the same procedure as for the LH side.

14. SEPARATE TIE ROD END SUB-ASSEMBLY LH

(a) Remove the clip and nut.

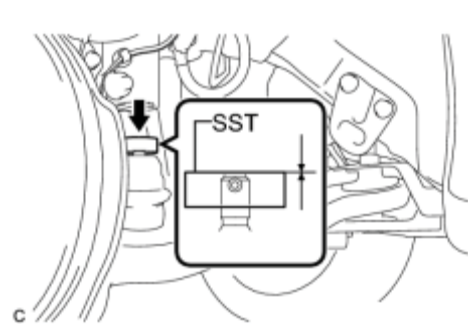

(b) Install SST to the tie rod end.

SST: 09960-20010

09961-02060

NOTICE:

Make sure that the upper ends of the tie rod end and SST are aligned.

(c) Using SST, separate the tie rod end from the steering knuckle.

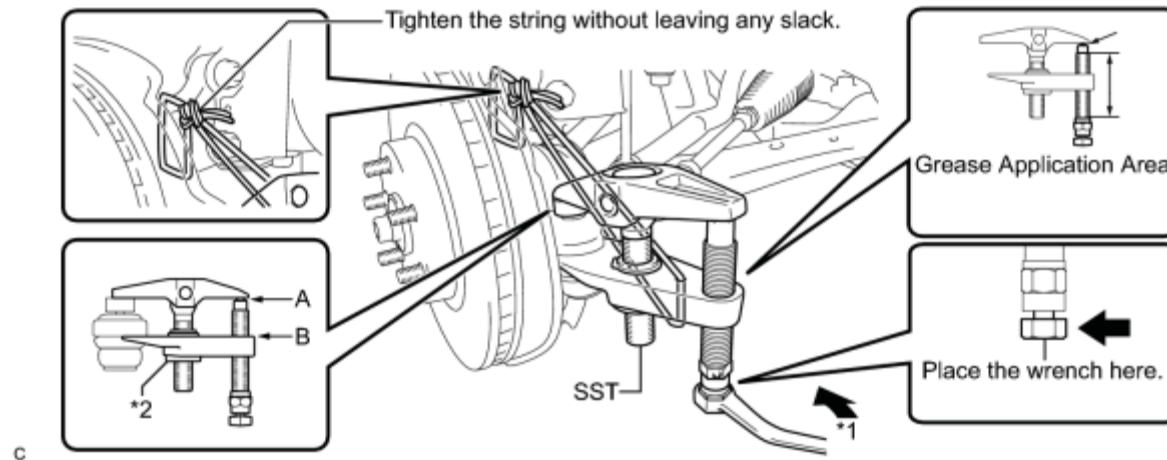

Text in Illustration

*1	Turn	*2	Nut
----	------	----	-----

SST: 09960-20010

09961-02010

CAUTION:

Apply grease to the bolt threads and the tip of SST.

NOTICE:

- Be sure to tighten the string firmly to secure SST to the steering knuckle to prevent SST from falling off.
- Install SST with the center nut so that A and B shown in the illustration are parallel. Otherwise, the dust cover may be damaged.
- Be sure to place the wrench on the part indicated in the illustration.
- Do not damage the front disc brake dust cover.
- Do not damage the ball joint dust cover.
- Do not damage the steering knuckle.

15. SEPARATE TIE ROD END SUB-ASSEMBLY RH

HINT:

Perform the same procedure as for the LH side.

16. SEPARATE FRONT NO. 1 LOWER SUSPENSION ARM SUB-ASSEMBLY LH_ INFO

17. SEPARATE FRONT NO. 1 LOWER SUSPENSION ARM SUB-ASSEMBLY RH

HINT:

Perform the same procedure as for the LH side.

18. REMOVE FRONT ENGINE MOUNTING BRACKET LOWER REINFORCEMENT_ INFO

19. REMOVE REAR SIDE RAIL REINFORCEMENT SUB-ASSEMBLY LH_ INFO

20. REMOVE REAR SIDE RAIL REINFORCEMENT SUB-ASSEMBLY RH

HINT:

Perform the same procedure as for the LH side.

21. REMOVE FRONT SUSPENSION MEMBER REAR BRACE LH_ INFO

22. REMOVE FRONT SUSPENSION MEMBER REAR BRACE RH

HINT:

Perform the same procedure as for the LH side.

23. REMOVE FRONT SUSPENSION CROSSMEMBER SUB-ASSEMBLY INFO

24. REMOVE NO. 1 STEERING COLUMN HOLE COVER SUB-ASSEMBLY

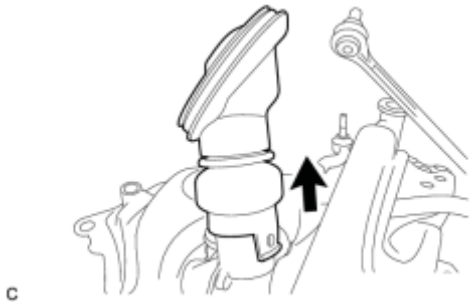

(a) Remove the No. 1 steering column hole cover sub-assembly from the steering link assembly.

25. REMOVE STEERING INTERMEDIATE SHAFT

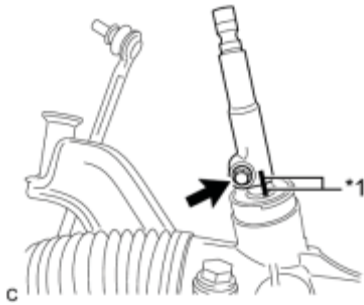

(a) Put matchmarks on the steering intermediate shaft and steering link assembly.

Text in Illustration

*1	Matchmark
----	-----------

(b) Remove the bolt and steering intermediate shaft from the steering link assembly.

26. REMOVE STEERING LINK ASSEMBLY

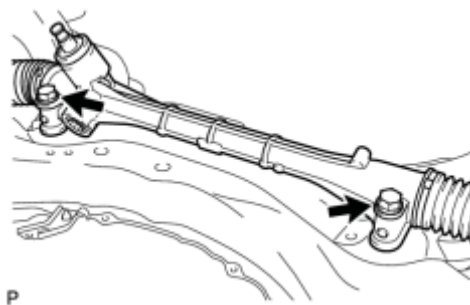

(a) Remove the 2 bolts, 2 nuts and steering link assembly from the front suspension crossmember sub-assembly.

NOTICE:

Keep the nut from rotating while turning the bolt because the nut has its own stopper.

27. SECURE STEERING LINK ASSEMBLY

(a) Using SST, secure the steering link assembly in a vise.

Text in Illustration

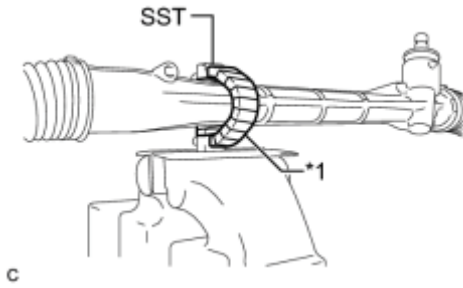

*1	Protective Tape
----	-----------------

SST: 09612-00012

HINT:

Tape SST before use.

28. REMOVE TIE ROD END SUB-ASSEMBLY LH

Text in Illustration

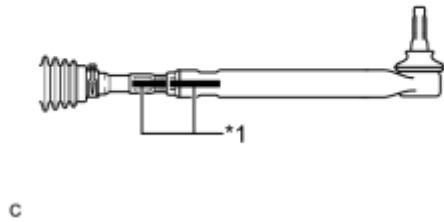

*1	Matchmark
----	-----------

(a) Put matchmarks on the tie rod end sub-assembly LH and steering gear assembly.

(b) Remove the tie rod end sub-assembly LH and lock nut.

29. REMOVE TIE ROD END SUB-ASSEMBLY RH

HINT:

Perform the same procedure as for the LH side.

DISASSEMBLY

1. REMOVE STEERING RACK BOOT CLIP LH

(a) Using pliers, remove the steering rack boot clip LH.

2. REMOVE STEERING RACK BOOT CLIP RH

HINT:

Perform the same procedure as for the LH side.

3. REMOVE NO. 2 STEERING RACK BOOT CLAMP

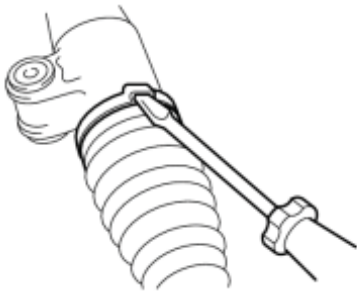

(a) Using a screwdriver, remove the No. 2 steering rack boot clamp.

NOTICE:

Be careful not to damage the steering rack boot.

4. REMOVE NO. 1 STEERING RACK BOOT CLAMP

HINT:

Perform the same procedure as for the No. 2 steering rack boot clamp.

5. REMOVE STEERING RACK BOOT LH

6. REMOVE STEERING RACK BOOT RH

INSPECTION

1. INSPECT TIE ROD END SUB-ASSEMBLY LH

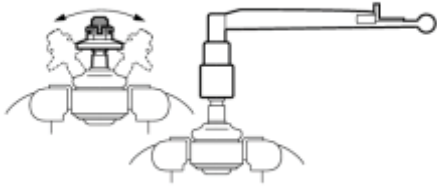

(a) Secure the tie rod end sub-assembly LH in a vise.

NOTICE:

Do not overtighten the vise.

c

(b) Install the nut to the stud bolt.

(c) Flip the ball joint back and forth 5 times.

(d) Set a torque wrench to the nut, turn the ball joint continuously at a rate of 2 to 4 seconds per turn, and check the turning torque on the 5th turn.

Standard turning torque:

0.3 to 1.9 N*m (3 to 19 kgf*cm, 3 to 17 in.*lbf)

HINT:

If the turning torque is not within the specified range, replace the tie rod end sub-assembly LH with a new one.

2. INSPECT TIE ROD END SUB-ASSEMBLY RH

HINT:

Perform the same procedure as for the LH side.

3. INSPECT TOTAL PRELOAD

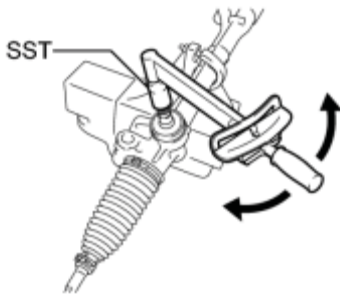

c

(a) Using SST and a torque wrench, inspect the total preload.

SST: 09616-00011

Standard preload:

0.7 to 1.1 N*m (7 to 11 kgf*cm, 6 to 9 in.*lbf)

NOTICE:

Inspect the total preload around the steering rack center position.

HINT:

If the total preload is not within the specified range, replace the steering gear assembly with a new one.

REASSEMBLY

1. INSTALL STEERING RACK BOOT LH

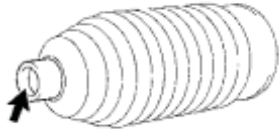

(a) Apply lithium soap base glycol grease to the inside of the small opening of a new steering rack boot LH.

P

C57765

(b) Install the steering rack boot LH to the groove on the rack housing.

NOTICE:

- Be careful not to damage or twist the boot.
- Make sure that the boot is free of rust and foreign matter.

2. INSTALL STEERING RACK BOOT RH

HINT:

Perform the same procedure as for the LH side.

3. INSTALL NO. 2 STEERING RACK BOOT CLAMP

(a) Using SST, tighten a new No. 2 steering rack boot clamp, as shown in the illustration.

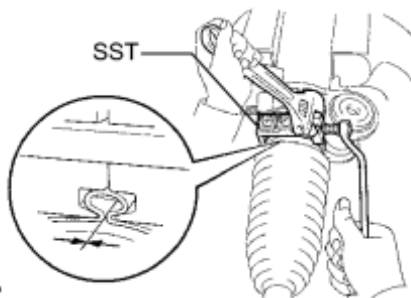

P

SST: 09521-24010

Clearance:

3.0 mm (0.118 in.) or less

NOTICE:

Be careful not to damage the steering rack boot.

4. INSTALL NO. 1 STEERING RACK BOOT CLAMP

HINT:

Perform the same procedure as for the No. 2 steering rack boot clamp.

SST: 09521-24010

5. INSTALL STEERING RACK BOOT CLIP LH

(a) Using pliers, install the steering rack boot clip LH.

6. INSTALL STEERING RACK BOOT CLIP RH

HINT:

Perform the same procedure as for the LH side.

7. INSPECT STEERING GEAR ASSEMBLY

(a) Using SST, rotate the pinion shaft to see if both the left and the right steering rack boots expand and contract smoothly.

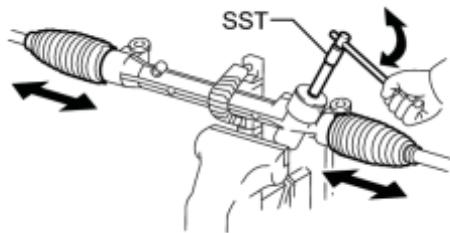

SST: 09616-00011

HINT:

If the operation cannot be done as specified, use a new steering rack boot clamp and reinstall the steering rack boots.

INSTALLATION

1. INSTALL TIE ROD END SUB-ASSEMBLY LH

(a) Install the lock nut and tie rod end sub-assembly LH to the steering gear assembly until the matchmarks are aligned.

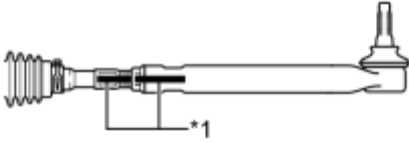

Text in Illustration

*1	Matchmark
----	-----------

HINT:

After adjusting the toe-in, tighten the lock nut.

c

2. INSTALL TIE ROD END SUB-ASSEMBLY RH

HINT:

Perform the same procedure as for the LH side.

3. INSTALL STEERING LINK ASSEMBLY

(a) Install the steering link assembly to the front suspension crossmember sub-assembly with the 2 bolts and 2 nuts.

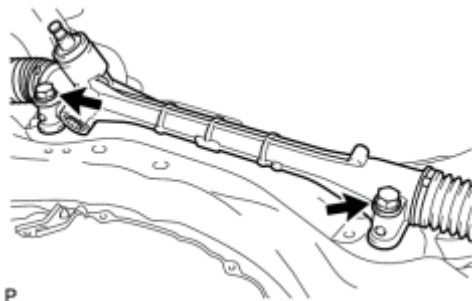

- Keep the nut from rotating while turning the bolt because the nut has its own stopper.
- Make sure to tighten the bolts starting from the left side of the vehicle.

Torque: **138 N·m (1407 kgf·cm, 102ft·lbf)**

P

4. INSTALL STEERING INTERMEDIATE SHAFT

(a) Align the matchmarks and install the steering intermediate shaft to the steering link assembly.

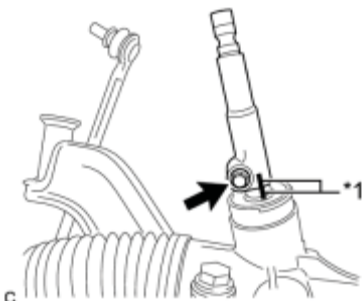

Text in Illustration

*1	Matchmark
----	-----------

(b) Install the bolt.

Torque: **35 N·m (357 kgf·cm, 26ft·lbf)**

5. INSTALL NO. 1 STEERING COLUMN HOLE COVER SUB-ASSEMBLY

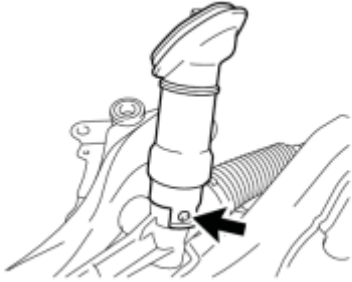

(a) Align the round hole in the No. 1 steering column hole cover sub-assembly with the protrusion of the steering link assembly to install the cover.

6. INSTALL FRONT SUSPENSION CROSSMEMBER SUB-ASSEMBLY INFO

7. INSTALL FRONT SUSPENSION MEMBER REAR BRACE LH INFO

8. INSTALL FRONT SUSPENSION MEMBER REAR BRACE RH

HINT:

Perform the same procedure as for the LH side.

9. INSTALL REAR SIDE RAIL REINFORCEMENT SUB-ASSEMBLY LH INFO

10. INSTALL REAR SIDE RAIL REINFORCEMENT SUB-ASSEMBLY RH

HINT:

Perform the same procedure as for the LH side.

11. INSTALL FRONT ENGINE MOUNTING BRACKET LOWER REINFORCEMENT INFO

12. CONNECT FRONT NO. 1 LOWER SUSPENSION ARM SUB-ASSEMBLY LH INFO

13. CONNECT FRONT NO. 1 LOWER SUSPENSION ARM SUB-ASSEMBLY RH

HINT:

Perform the same procedure as for the LH side.

14. CONNECT TIE ROD END SUB-ASSEMBLY LH

(a) Connect the tie rod end sub-assembly LH to the steering knuckle with the nut.

Torque: **49 N·m (500 kgf·cm, 36ft·lbf)**

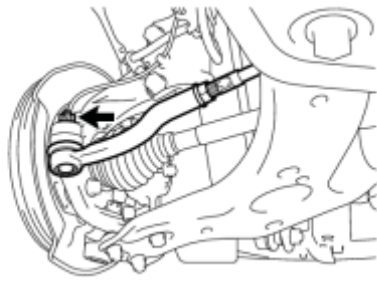

NOTICE:

Further tighten the nut up to 60° if the holes for the clip are not aligned.

c

(b) Install a new clip.

15. CONNECT TIE ROD END SUB-ASSEMBLY RH

HINT:

Perform the same procedure as for the LH side.

16. CONNECT FRONT STABILIZER LINK ASSEMBLY LH INFO

17. CONNECT FRONT STABILIZER LINK ASSEMBLY RH

HINT:

Perform the same procedure as for the LH side.

18. CONNECT NO. 1 STEERING COLUMN HOLE COVER SUB-ASSEMBLY

(a) Place clip A as shown in the illustration and engage clip B to the body to connect the No. 1 steering column hole cover sub-assembly.

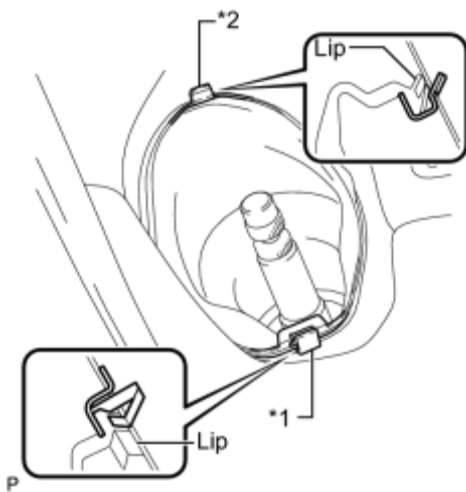

Text in Illustration

*1	Clip A
*2	Clip B

NOTICE:

Make sure that the lips of the No. 1 steering column hole cover sub-assembly are not damaged.

19. CONNECT NO. 2 STEERING INTERMEDIATE SHAFT ASSEMBLY INFO

20. PLACE FRONT WHEELS FACING STRAIGHT AHEAD

21. INSTALL COLUMN HOLE COVER SILENCER SHEET INFO

22. INSTALL REAR ENGINE UNDER COVER LH

23. INSTALL REAR ENGINE UNDER COVER RH

HINT:

Perform the same procedure as for the LH side.

24. INSTALL FRONT NO. 3 ENGINE UNDER COVER

25. INSTALL NO. 2 ENGINE UNDER COVER

26. INSTALL NO. 1 ENGINE UNDER COVER

27. INSTALL FRONT WHEELS

Torque: **103 N·m (1050 kgf·cm, 76ft·lbf)**

28. STABILIZE SUSPENSION_ NFC

29. INSPECT AND ADJUST FRONT WHEEL ALIGNMENT

(a) Inspect and adjust the front wheel alignment NFC.

ADJUSTMENT

NOTICE:

If the wheel alignment has been adjusted, and if suspension or underbody components have been removed/installed or replaced, be sure to perform the following initialization procedure in order for the system to function normally:

- Perform zero point calibration of the yaw rate and acceleration sensor.

1. INSPECT TIRES

INFO

2. MEASURE VEHICLE HEIGHT

- Before inspecting the wheel alignment, adjust the vehicle height to the specified value.
- Be sure to perform measurement on a level surface.
- If it is necessary to go under the vehicle for measurement, confirm that the parking brake is applied and the vehicle is secured with chocks.
- Inspect while the vehicle is unloaded.

(a) Bounce the vehicle up and down at the corners to stabilize the suspension.

(b) Measure the vehicle height.

Measurement points:

A: Ground clearance of front No. 1 lower suspension arm bushing set bolt center

B: Ground clearance of rear axle beam bushing set bolt center

C: Ground clearance of front wheel center

D: Ground clearance of rear wheel center

Vehicle Height (Unloaded Vehicle):

Tire Size	Front C - A	Rear D - B
195/65R15	108 mm (4.25 in.)	26 mm (1.02 in.)
	90 mm (3.54 in.)*	9 mm (0.354 in.)*
215/45R17	103 mm (4.06 in.)	21 mm (0.827 in.)

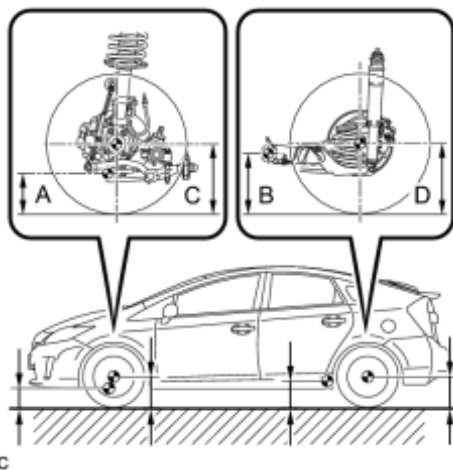

* For vehicle height for Rough Road Package.

3. INSPECT CAMBER, CASTER AND STEERING AXIS INCLINATION

NOTICE:

Inspect while the vehicle is unloaded.

(a) Install a camber-caster-kingpin gauge and place the front wheels on the center of a wheel alignment tester.

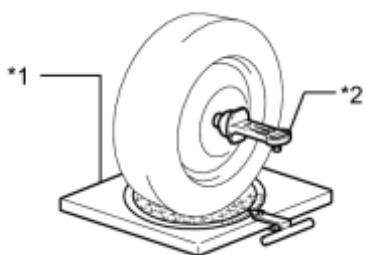

Text in Illustration

*1	Wheel Alignment Tester
*2	Gauge

(b) Inspect the camber, caster and steering axis inclination.

Camber (Unloaded Vehicle):

Tire Size	Camber Inclination	Right-left Difference
195/65R15	-0°13' +/- 45' (-0.22° +/- 0.75°)	45' (0.75°) or less
	-0°07' +/- 45' (-0.12° +/- 0.75°)*	
215/45R17	-0°12' +/- 45' (-0.20° +/- 0.75°)	

* For vehicle height for Rough Road Package.

Caster (Unloaded Vehicle):

Tire Size	Caster Inclination	Right-left Difference
195/65R15	5°53' +/- 45' (5.88° +/- 0.75°)	45' (0.75°) or less
	5°40' +/- 45' (5.67° +/- 0.75°)*	
215/45R17	5°50' +/- 45' (5.83° +/- 0.75°)	

* For vehicle height for Rough Road Package.

Steering Axis Inclination (Unloaded Vehicle):

Tire Size	Steering Axis Inclination
195/65R15	12°16' (12.27°)
	11°52' (11.87°)*

Tire Size	Steering Axis Inclination
215/45R17	12°10' (12.17°)

* For vehicle height for Rough Road Package.

4. ADJUST CAMBER

NOTICE:

Inspect toe-in after the camber has been adjusted.

(a) Remove the front wheel.

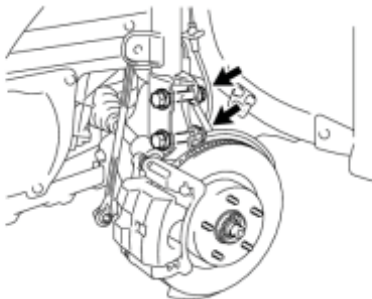

c

(b) Loosen the 2 nuts.

NOTICE:

Keep the bolts inserted.

(c) Clean the installation surfaces of the front shock absorber and the steering knuckle.

(d) Temporarily install the 2 nuts. (Step A)

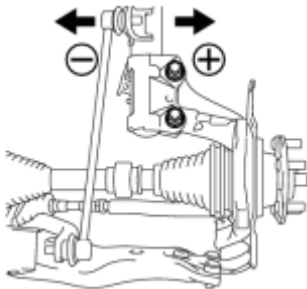

P

(e) Fully push or pull the front axle hub in the direction of the required adjustment. (Step B)

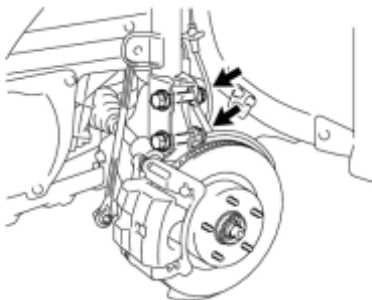

c

(f) Tighten the nuts.

Torque: **240 N·m (2447 kgf·cm, 177ft·lbf)**

NOTICE:

Keep the bolts from rotating when tightening the nuts.

(g) Install the front wheel.

Torque: **103 N·m (1050 kgf·cm, 76ft·lbf)**

2010 Toyota Prius

Repair Manual

(h) Check the camber.

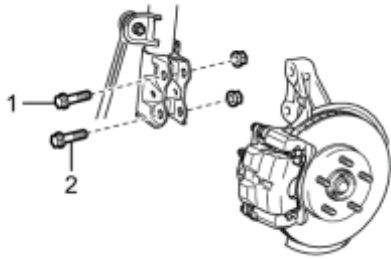

c

If the measured value is not within the specification, calculate the required adjustment amount using the formula below.

Camber adjustment amount = center of the specified range - measured value















Check the combination of the installed bolts. Select appropriate bolts from the tables below to adjust the camber to the specified values.

HINT:

Try to adjust the camber to the center of the specified values.

Move the axle hub toward (+) in step B	Move the axle hub toward (-) in step B
Refer to table (1) (Move the axle hub toward the positive side)	Refer to table (2) (Move the axle hub toward the negative side)

Table (1) (Move the axle hub toward the positive side)

Installed Bolt	1	 90105-17019	 90105-17019	 90105-17019	 90105-17019	 90105-17016	 90105-17017	 90105-17018
	2	 90105-17019	 90105-17016	 90105-17017	 90105-17018	 90105-17018	 90105-17018	 90105-17018
Adjusting Value	-1°30' to -1°15' (-1.50° to -1.25°)							G
	-1°15' to -1°00' (-1.25° to -1°)						G	A
	-1°00' to -0°45' (-1° to -0.75°)					G	A	B
	-0°45' to -0°30' (-0.75° to -0.5°)				G	A	B	C
	-0°30' to -0°15' (-0.5° to -0.25°)			G	A	B	C	D
	-0°15' to 0° (-0.25° to 0°)		G	A	B	C	D	E
	0° to 0°15' (0° to 0.25°)	A	B	C	D	E	F	
	0°15' to 0°30' (0.25° to 0.5°)	B	C	D	E	F		
	0°30' to 0°45' (0.5° to 0.75°)	C	D	E	F			
	0°45' to 1°00' (0.75° to 1°)	D	E	F				
	1°00' to 1°15' (1° to 1.25°)	E	F					
	1°15' to 1°30' (1.25° to 1.5°)	F						

Selected Bolt Combination











































	A	B	C	D	E	F	G
1	 90105-17019	 90105-17019	 90105-17019	 90105-17016	 90105-17017	 90105-17018	 90105-17019
2	 90105-17016	 90105-17017	 90105-17018	 90105-17018	 90105-17018	 90105-17018	 90105-17019

Table (2) (Move the axle hub toward the negative side)

Installed Bolt	1							
	2							
Adjusting Value		90105-17019	90105-17016	90105-17017	90105-17018	90105-17018	90105-17018	90105-17018
-1°30' to -1°15' (-1.50° to -1.25°)	F							
-1°15' to -1°00' (-1.25° to -1°)	E	F						
-1°00' to -0°45' (-1° to -0.75°)	D	E	F					
-0°45' to -0°30' (-0.75° to -0.5°)	C	D	E	F				
-0°30' to -0°15' (-0.5° to -0.25°)	B	C	D	E	F			
-0°15' to 0° (-0.25° to 0°)	A	B	C	D	E	F		
0° to 0°15' (0° to 0.25°)		G	A	B	C	D	E	
0°15' to 0°30' (0.25° to 0.5°)			G	A	B	C	D	
0°30' to 0°45' (0.5° to 0.75°)				G	A	B	C	
0°45' to 1°00' (0.75° to 1°)					G	A	B	
1°00' to 1°15' (1° to 1.25°)						G	A	
1°15' to 1°30' (1.25° to 1.5°)							G	

Selected Bolt Combination

	A	B	C	D	E	F	G
1							
	90105-17019	90105-17019	90105-17019	90105-17016	90105-17017	90105-17018	90105-17019
2							
	90105-17016	90105-17017	90105-17018	90105-17018	90105-17018	90105-17018	90105-17019

NOTICE:

Replace the nut with a new one when replacing the bolt.

The body and suspension may be damaged if the camber is not correctly adjusted according to the tables above.

(i) Repeat the steps mentioned above. In Step A, replace 1 or 2 selected bolts.

HINT:

Replace one bolt at a time when replacing both bolts.

5. INSPECT TOE-IN

NOTICE:

Inspect while the vehicle is unloaded.

(a) Bounce the vehicle up and down at the corners to stabilize the suspension.

(b) Release the parking brake and move the shift lever to N.

(c) Push the vehicle straight ahead approximately 5 m (16.4 ft.). (Step C)

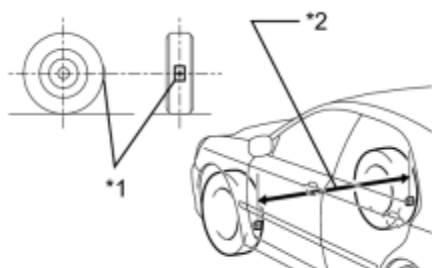

(d) Put tread center marks on the rearmost points of the front wheels and measure the distance between the marks (dimension B).

Text in Illustration

*1	Tread Center Mark
*2	Dimension B

(e) Slowly push the vehicle straight ahead to cause the front wheels to rotate 180° using the front tire valve as a reference point.

HINT:

Do not allow the wheels to rotate more than 180°. If the wheels rotate more than 180°, perform the procedure from Step C again.

(f) Measure the distance between the tread center marks on the front side of the wheels (dimension A).

Text in Illustration

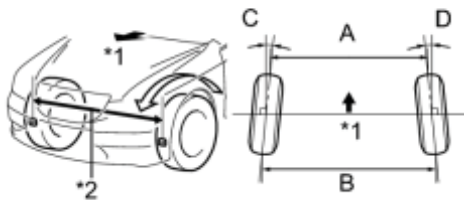

*1	Front of the Vehicle
*2	Dimension A

To-in (Unloaded Vehicle)

Specified Condition
C + D: 0°12' +/- 0°12' (0.20° +/- 0.20°)
C + D: 0°18' +/- 0°12' (0.30° +/- 0.20°)*
B - A: 2.0 +/- 2.0 mm (0.0787 +/- 0.0787 in.)
B - A: 3.0 +/- 2.0 mm (0.118 +/- 0.0787 in.)*

* For vehicle height for Rough Road Package.

HINT:

Measure "B - A" only when "C + D" cannot be measured.

If the toe-in is not within the specified range, adjust it at the rack ends.

6. ADJUST TOE-IN

(a) Make sure that the thread length of the right and left rack ends are approximately the same.

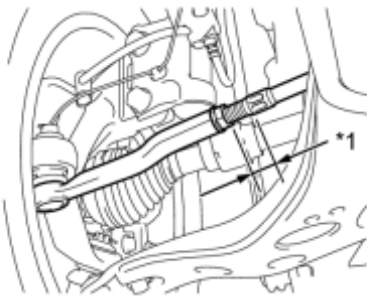

Text in Illustration

*1	Thread Length
----	---------------

Standard difference:

1.5 mm (0.0591 in.) or less

(b) Remove the boot clips.

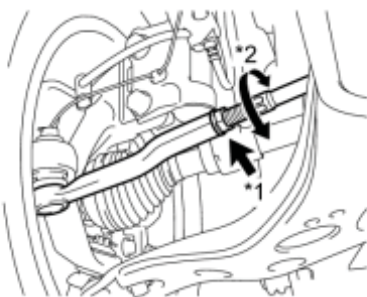

(c) Loosen the tie rod end lock nuts.

Text in Illustration

*1	Loosen
*2	Turn

(d) Adjust the rack ends if the difference in thread length between the right and left rack ends is not within the specified range.

(1) Extend the shorter rack end if the measured toe-in deviates toward the outer-side.

(2) Shorten the longer rack end if the measured toe-in deviates toward the inner-side.

(e) Turn the right and left rack ends by an equal amount to adjust the toe-in to the center value.

(f) Make sure that the thread lengths of the right and left rack ends are the same.

(g) Tighten the tie rod end lock nuts.

Torque: **74 N·m (755 kgf·cm, 55ft·lbf)**

(h) Place the boots on the seats and install the clips.

HINT:

Make sure that the boots are not twisted.

7. INSPECT WHEEL ANGLE

Text in Illustration

*1	Front of the Vehicle
*2	Inside
*3	Outside

(a) Put tread center marks on the rearmost points of a turning radius gauge.

(b) Turn the steering wheel to the left and right full lock positions, and measure the turning angle.

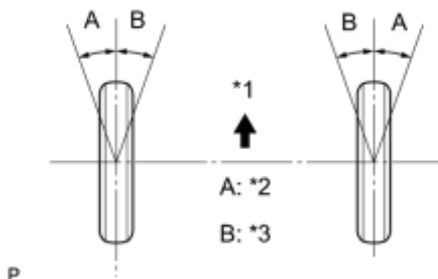

NOTICE:

Inspect while the vehicle is unloaded.

Wheel Angle (Unloaded Vehicle):

Tire Size	Inside Wheel	Outside Wheel Reference
195/65R15	40°50' +/- 2° (40.83° +/- 2°)	33°50' (33.83°)
	37°42' +/- 2° (37.70° +/- 2°)*	32°13' (32.22°)*
215/45R17	37°27' +/- 2° (37.45° +/- 2°)	31°56' (31.93°)

* For vehicle height for Rough Road Package.

If the angles are not as specified, check and adjust the right and left rack end lengths.

8. PLACE FRONT WHEELS FACING STRAIGHT AHEAD

9. PERFORM YAW RATE AND ACCELERATION SENSOR CALIBRATION

INFO .

10. PERFORM INITIALIZATION (w/ Height Control Sensor)

NOTICE:

Some systems need to be initialized after the wheel alignment is adjusted INFO .

INSPECTION

NOTICE:

If the wheel alignment has been adjusted, and if suspension or underbody components have been removed/installed or replaced, be sure to perform the following initialization procedure in order for the system to function normally:

- Perform zero point calibration of the yaw rate and acceleration sensor and test mode inspection.

1. INSPECT TIRES

INFO

2. MEASURE VEHICLE HEIGHT_

INFO

3. INSPECT CAMBER

NOTICE:

Inspect while the vehicle is unloaded.

- (a) Install a camber-caster-kingpin gauge.
- (b) Inspect the camber.

Camber (Unloaded Vehicle):

Tire Size	Camber Inclination	Right-left Difference
195/65R15	-1°29' +/- 30' (-1.48° +/- 0.50°)	30' (0.50°) or less
215/45R17	-1°28' +/- 30' (-1.47° +/- 0.50°)	

HINT:

Camber is not adjustable. If the measurement is not within the specified range, inspect the suspension parts for damage and/or wear, and replace them if necessary.

4. INSPECT TOE-IN

NOTICE:

Inspect while the vehicle is unloaded.

- (a) Bounce the vehicle up and down at the corners to stabilize the suspension.
- (b) Release the parking brake and move the shift lever to N.
- (c) Push the vehicle straight ahead approximately 5 m (16.4 ft.). (Step A)

(d) Put tread center marks on the rearmost points of the rear wheels and measure the distance between the marks (dimension B).

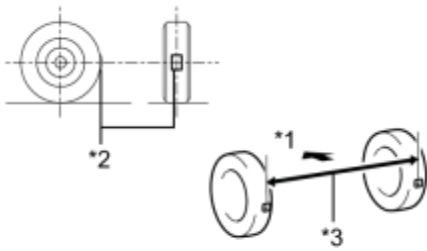

Text in Illustration

*1	Front of the Vehicle
*2	Tread Center Mark
*3	Dimension B

(e) Slowly push the vehicle straight ahead to cause the rear wheels to rotate 180° using the rear tire valve as a reference point.

HINT:

Do not allow the wheels to rotate more than 180°. If the wheels rotate more than 180°, perform the procedure from Step A again.

(f) Measure the distance between the tread center marks on the front side of the wheels (dimension A).

Text in Illustration

*1	Front of the Vehicle
*2	Dimension A

Toe-in (Unloaded Vehicle):

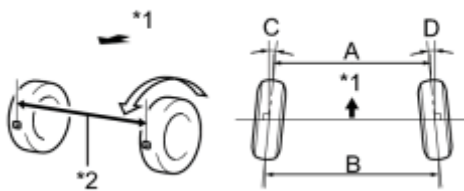

Tire Size	Specified Condition	Right-left Difference
195/65R15	C + D: 0°17' +/- 18' (0.29° +/- 0.30°)	45' (0.75°) or less
	C + D: 0°10' +/- 18' (0.17° +/- 0.30°)*	
	B - A: 2.9 +/- 3 mm (0.114 +/- 0.118 in.)	-
B - A: 1.7 +/- 3 mm (0.0669 +/- 0.118 in.)*		
215/45R17	C + D: 0°15' +/- 18' (0.25° +/- 0.30°)	45' (0.75°) or less
	B - A: 2.5 +/- 3 mm (0.0984 +/- 0.118 in.)	-

* For vehicle height for Rough Road Package.

HINT:

Measure "B - A" only when "C + D" cannot be measured.

If the toe-in is not within the specified range, inspect the suspension parts and replace them if necessary.