

FRONT WHEEL ALIGNMENT

ADJUSTMENT

1. INSPECT TIRE

(a) Inspect the tires (see page TW-3).

2. MEASURE VEHICLE HEIGHT

Standard vehicle height

Item	Specified Condition
Front (A - B)	95 mm (3.74 in.)
Rear (D - C)	62 mm (2.44 in.)

Measuring points:

A:

Ground clearance of front wheel center

B:

Ground clearance of lower arm No. 1 set bolt center

C:

Ground clearance of rear axle carrier bush set bolt center

D:

Ground clearance of rear wheel center

NOTICE:

Before inspecting the wheel alignment, adjust the vehicle height to the specified value.

HINT:

Bounce the vehicle at the corners up and down to stabilize the suspension and inspect the vehicle height.

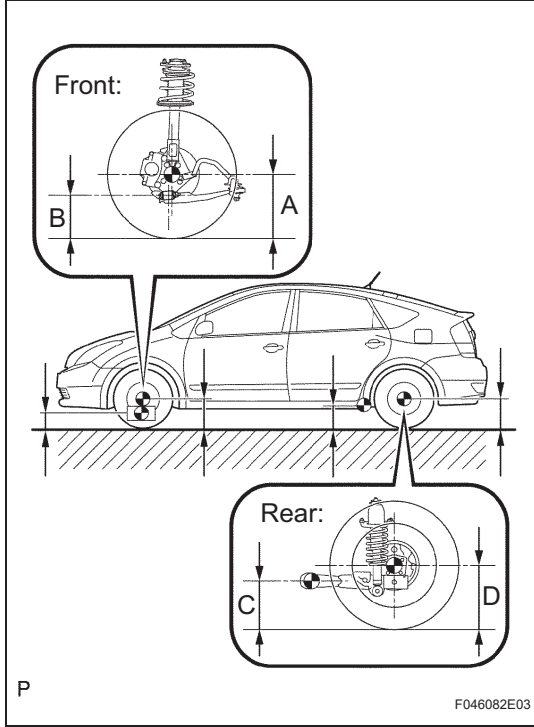

3. INSPECT TOE-IN

Standard toe-in

Item	Specified Condition
Toe-in (total)	A + B: 0° +12' (0° +0.2°) C - D: 0 +2 mm (0 +0.08 in.)

HINT:

- Measure "C - D" only when "A + B" cannot be measured.
- If the toe-in is not within the specified range, adjust it at the rack ends.

4. ADJUST TOE-IN

(a) Measure the thread lengths of the right and left rack ends.

Standard difference in thread length:

1.5 mm (0.059 in.) or less

(b) Remove the rack boot set clips.

(c) Loosen the tie rod end lock nuts.

(d) Adjust the rack ends if the difference in thread length between the right and left rack ends is not within the specified range.

(1) Extend the shorter rack end if the measured toe-in deviates toward the outer-side.

(2) Shorten the longer rack end if the measured toe-in deviates toward the inner-side.

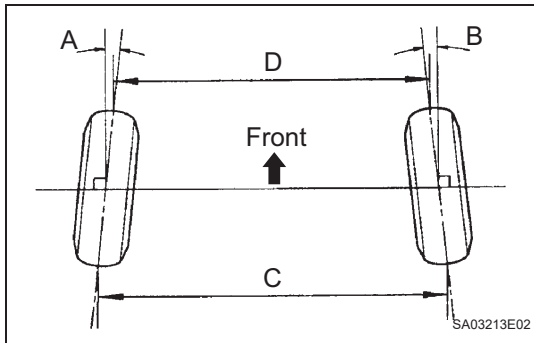

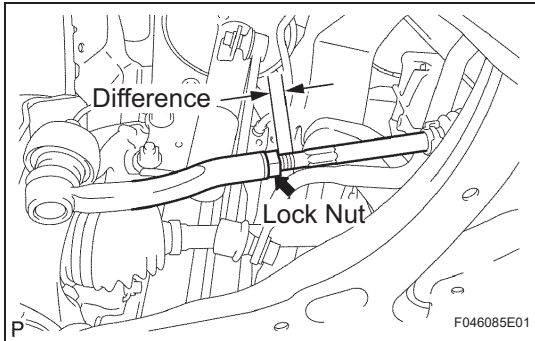

- (e) Turn the right and left rack ends by an equal amount to adjust toe-in.
HINT:
Try to adjust toe-in to the center of the specified range.

- (f) Make sure that the lengths of the right and left rack ends are the same.

Standard :
0 +1 mm (0.0039 in.)

- (g) Torque the tie rod end lock nuts.
Torque: 74 N*m (755 kgf*cm, 55 ft.*lbf)

NOTICE:
Temporarily tighten the lock nut while holding the hexagonal part of the steering rack end so that the lock nut and the steering rack end do not turn together. Hold the width across the flat part of the tie rod end and tighten the lock nut.

- (h) Place the boots on the seats and install the clips.
HINT:
Make sure that the boots are not twisted.
- (i) Perform VSC system calibration (see page BC-21).

5. INSPECT WHEEL ANGLE

- (a) Fully turn the steering wheel to the left and right and measure the turning angle.

Standard wheel turning angle

Item	Specified Condition
Inside wheel	40° 35' +2° (40.58° +2°)
Outside wheel: Reference	34° 15' (34.25°)

If the right and left inside wheel angles differ from the specified range, check the right and left rack end lengths.

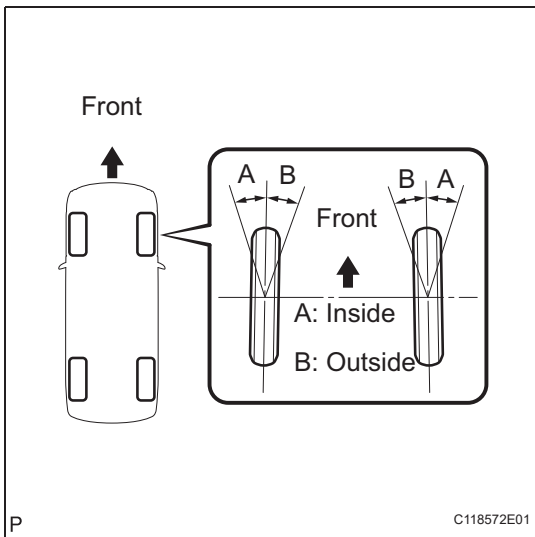

6. INSPECT CAMBER, CASTER AND STEERING AXIS INCLINATION

- (a) Put the front wheel on the center of the alignment tester.
- (b) Remove the center ornament.
- (c) Install the camber-caster-steering axis inclination gauge at the center of the axle hub or drive shaft.
- (d) Inspect the camber, caster and steering axis inclination.

Standard camber, caster and steering axis inclination

Item	Specified Condition
Camber	-0° 35' +45' (-0.58° +0.75°)
Right-left error	45' (0.75°) or less
Caster	3° 10' +45' (3.17° +0.75°)
Right-left error	45' (0.75°) or less

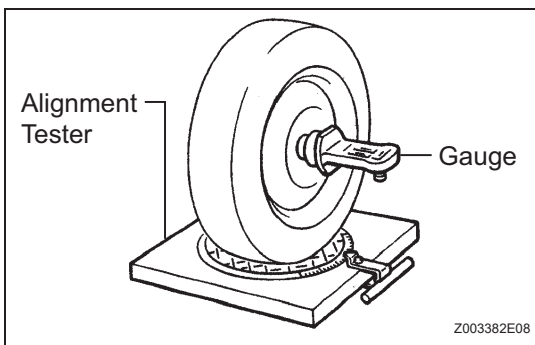

Item	Specified Condition
Steering axis inclination	12° 35' +45' (12.58° +0.75°)
Right-left error	45' (0.75°) or less

NOTICE:

- Inspect with an empty vehicle (without the spare tire or tools).
 - The maximum tolerance of the right and left difference for the camber and caster is 45' or less.
- (e) Remove the camber-caster-steering axis inclination gauge and attachment.
- (f) Install the center ornament.
If the caster and steering axis inclination are not within the specified values after the camber has been correctly adjusted, recheck the suspension parts for damage and/or wear.

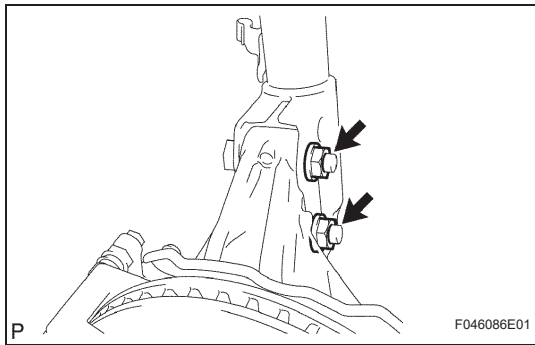

7. ADJUST CAMBER

NOTICE:

Inspect toe-in after the camber has been adjusted.

- (a) Remove the front wheel.
- (b) Remove the 2 nuts on the lower side of the shock absorber.

NOTICE:

When removing the nut, stop the bolt from rotating and loosen the nut.

- (c) Clean the installation surfaces of the shock absorber and the steering knuckle.
- (d) Temporarily install the 2 nuts.
- (e) Fully push or pull the front axle hub in the direction of the required adjustment.
- (f) Tighten the nuts.

Torque: 153 N*m (1,560 kgf*cm, 113 ft.*lbf)

NOTICE:

Keep the bolts from rotating and torque the nuts.

- (g) Install the front wheel.
- Torque: 103 N*m (1,050 kgf*cm, 76 ft.*lbf)**
- (h) Check the camber.

If the measured value is not within the specified range, calculate the required adjustment amount using the formula below.

Camber adjustment amount:

Center of the specified range - Measured value

Check the installed bolt combination. Select appropriate bolts from the table below to adjust the camber to within the specified range.

Standard selection table

Item	Selection Table
Move the axle toward (+) in step (e)	Refer to table (1) (Move the axle toward positive side)
Move the axle toward (-) in step (e)	Refer to table (2) (Move the axle toward negative side)

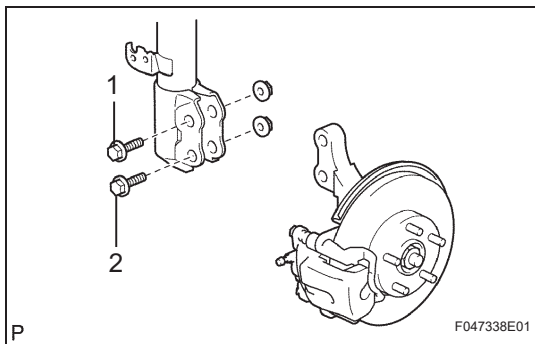
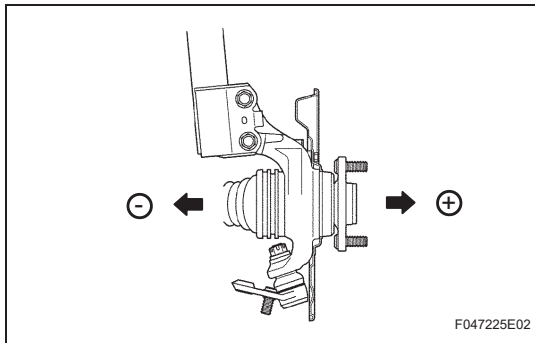















- (i) Measure the camber with the bolts currently installed and check the amount of looseness from the specified range. (Ex: The measured value is - 1°35')
- (j) Determine whether the direction of the required adjustment is toward the positive or negative side. (Ex: Refer to table (1) (Move the axle toward positive side))
- (k) Check the required adjustment amount from the measured value. (Table (1), Table (2)) (Ex: Select "Adjust value: 0°45' to 1°00")
- (l) Check the currently installed bolt combination. (Ex: "Installed bolt 1: no dot; Installed bolt 2: 2 dots")
- (m) Select the adjusting bolts. (Ex: "Selected Bolt Combination" results in F for installed bolt 1: 3 dots; Installed bolt 2: 3 dots)
- (n) Measure the alignment again and check that it is within the specified range. (Ex: Measured value is within -0° 35' +45')





Table (1) (Move the axle toward positive side)

Installed Bolt Adjusting Value	1	No Dot	No Dot	No Dot	No Dot	1 Dot	2 Dots	3 Dots
	2	No Dot	1 Dot	2 Dots	3 Dots	3 Dots	3 Dots	3 Dots
-1° 30' to -1° 15'								G
-1° 15' to -1° 00'							G	A
-1° 00' to -0° 45'						G	A	B
-0° 45' to -0° 30'					G	A	B	C
-0° 30' to -0° 15'				G	A	B	C	D
-0° 15' to 0°		G	A	B	C	D	E	F
0° to 0° 15'	A	B	C	D	E	F		
0° 15' to 0° 30'	B	C	D	E	F			
0° 30' to 0° 45'	C	D	E	F				
0° 45' to 1° 00'	D	E	F					
1° 00' to 1° 15'	E	F						
1° 15' to 1° 30'	F							

Selected Bolt Combination

	A	B	C	D	E	F	G
1	 90105-15018	 90105-15018	 90105-15018	 90105-15015	 90105-15016	 90105-15017	 90105-15018
2	 90105-15015	 90105-15016	 90105-15017	 90105-15017	 90105-15017	 90105-15017	 90105-15018

Bolt Distinguishing Mark

No Dot	1 Dot	2 Dots	3 Dots
 90105-15018	 90105-15015	 90105-15016	 90105-15017

The body and suspension may be damaged if the camber is not correctly adjusted according to the above table.

NOTICE:

Replace the nut with a new one when replacing the bolt.

(o) Repeat the steps mentioned above. At step (b), replace 1 or 2 selected bolts.















HINT:

Replace 1 bolt at a time when replacing 2 bolts.





Table (2) (Move the axle toward negative side)

Installed Bolt Adjusting Value	1	No Dot	No Dot	No Dot	No Dot	1 Dot	2 Dots	3 Dots
	2	No Dot	1 Dot	2 Dots	3 Dots	3 Dots	3 Dots	3 Dots
-1° 30' to -1° 15'		F	/	/	/	/	/	/
-1° 15' to -1° 00'		E	F	/	/	/	/	/
-1° 00' to -0° 45'		D	E	F	/	/	/	/
-0° 45' to -0° 30'		C	D	E	F	/	/	/
-0° 30' to -0° 15'		B	C	D	E	F	/	/
-0° 15' to 0°		A	B	C	D	E	F	/
0° to 0° 15'	/		G	A	B	C	D	E
0° 15' to 0° 30'	/	/		G	A	B	C	D
0° 30' to 0° 45'	/	/	/		G	A	B	C
0° 45' to 1° 00'	/	/	/	/		G	A	B
1° 00' to 1° 15'	/	/	/	/	/		G	A
1° 15' to 1° 30'	/	/	/	/	/	/		G

Selected Bolt Combination

	A	B	C	D	E	F	G
1	 90105-15018	 90105-15018	 90105-15018	 90105-15015	 90105-15016	 90105-15017	 90105-15018
2	 90105-15015	 90105-15016	 90105-15017	 90105-15017	 90105-15017	 90105-15017	 90105-15018

Bolt Distinguishing Mark

No Dot	1 Dot	2 Dots	3 Dots
 90105-15018	 90105-15015	 90105-15016	 90105-15017

T

C125768E02

The body and suspension may be damaged if the camber is not correctly adjusted according to the above table.

(p) Repeat the steps mentioned above. At step (b), replace 1 or 2 selected bolts.

NOTICE:

Replace the nut with a new one when replacing the bolt.

HINT:

Replace 1 bolt at a time when replacing 2 bolts.