

Interior Light

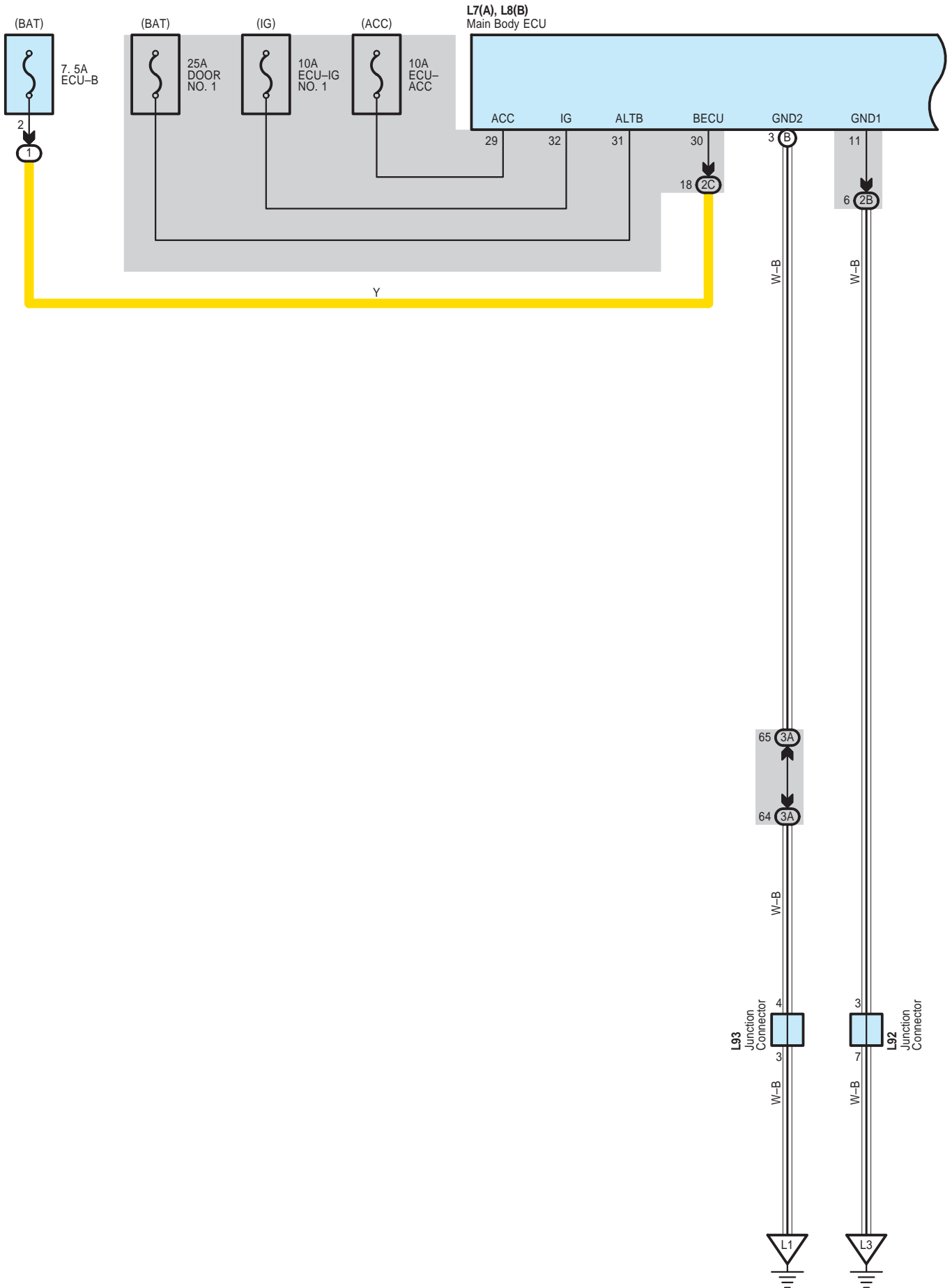

Interior Light

L7(A), L8(B)
Main Body ECU

See also: Interior Elec. connector locations.pdf

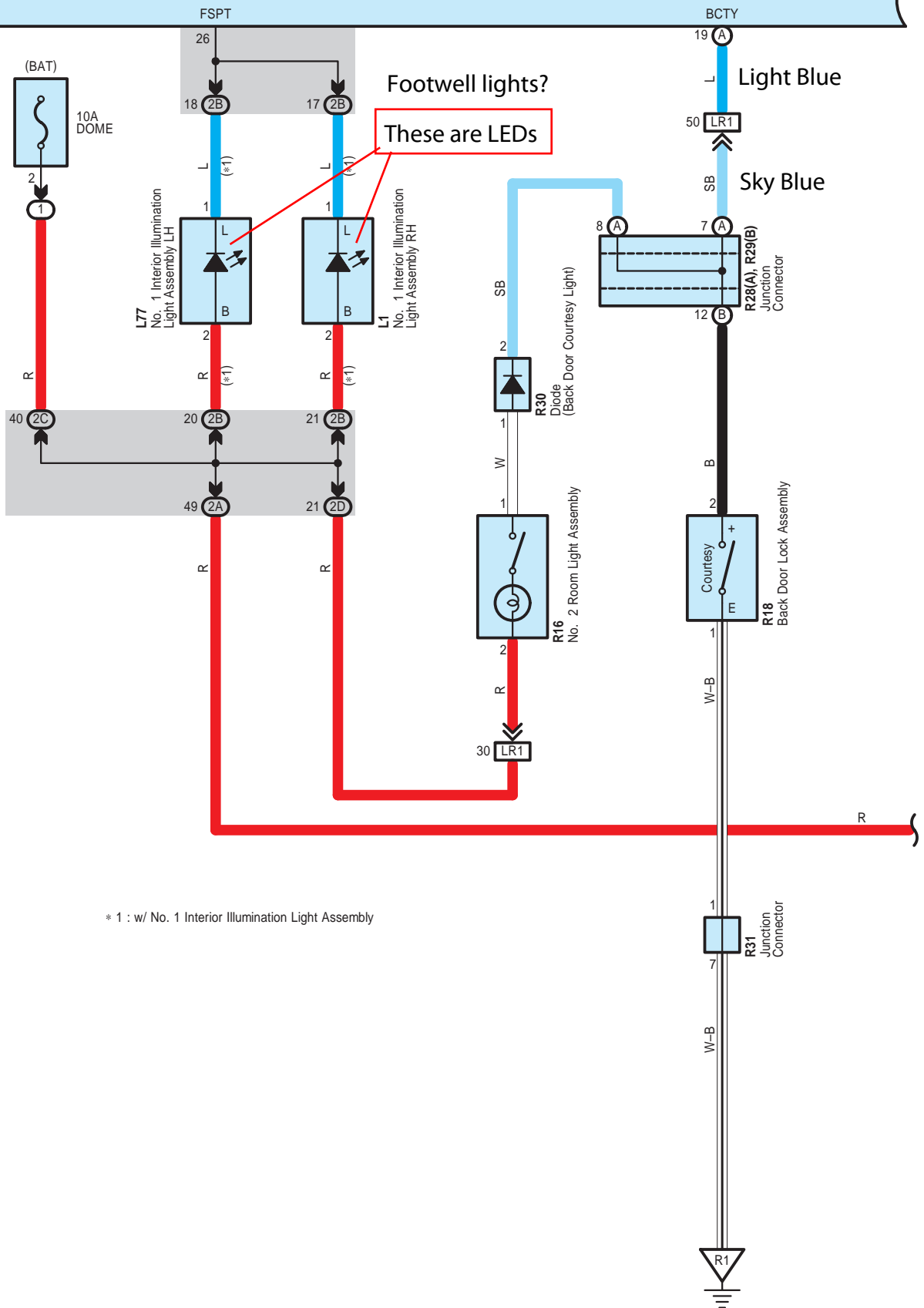

Interior Light

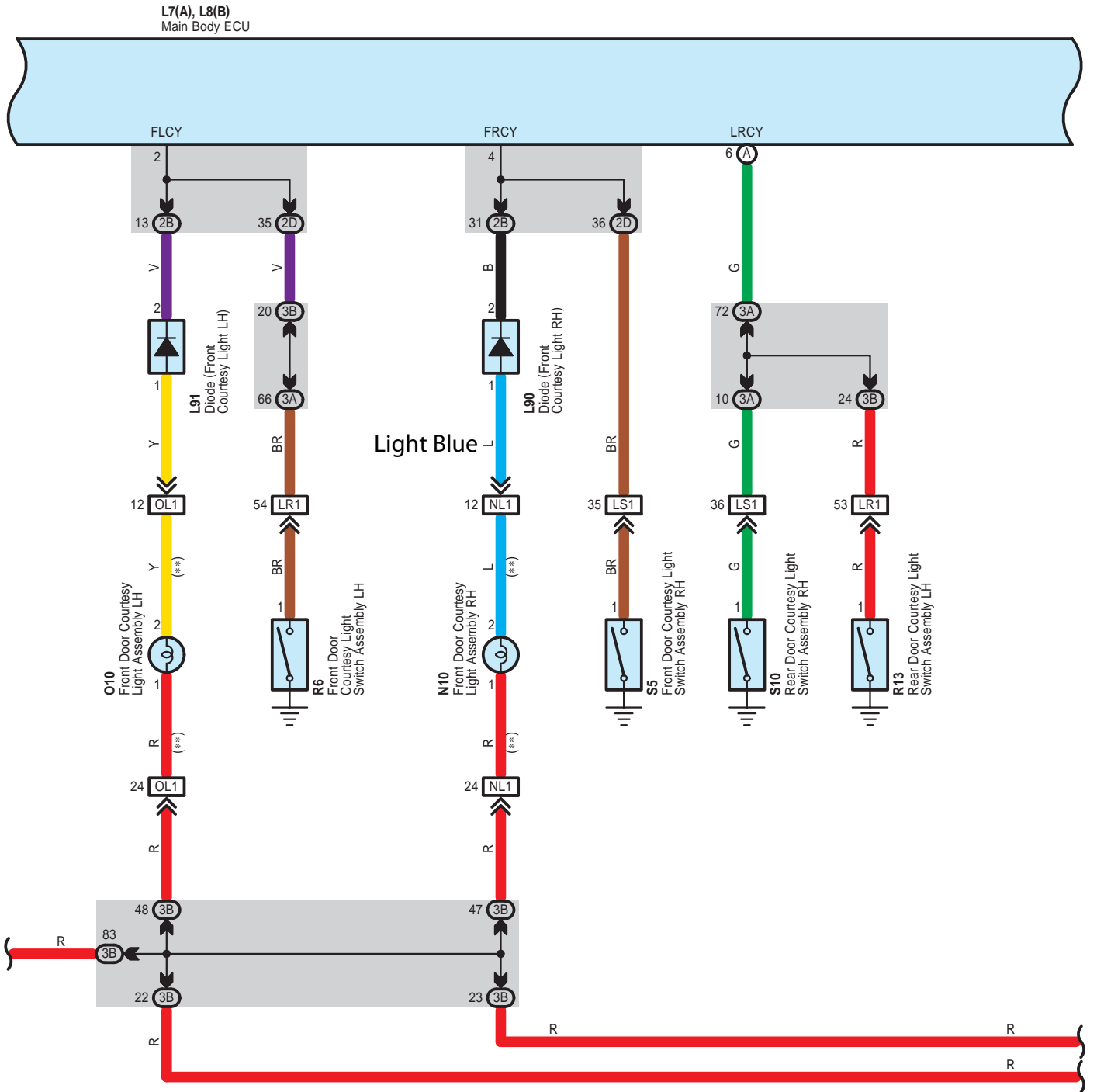

When wiring colors are indicated with (**), either the colored wiring (general wiring) or the painted wiring is used.

Interior Light

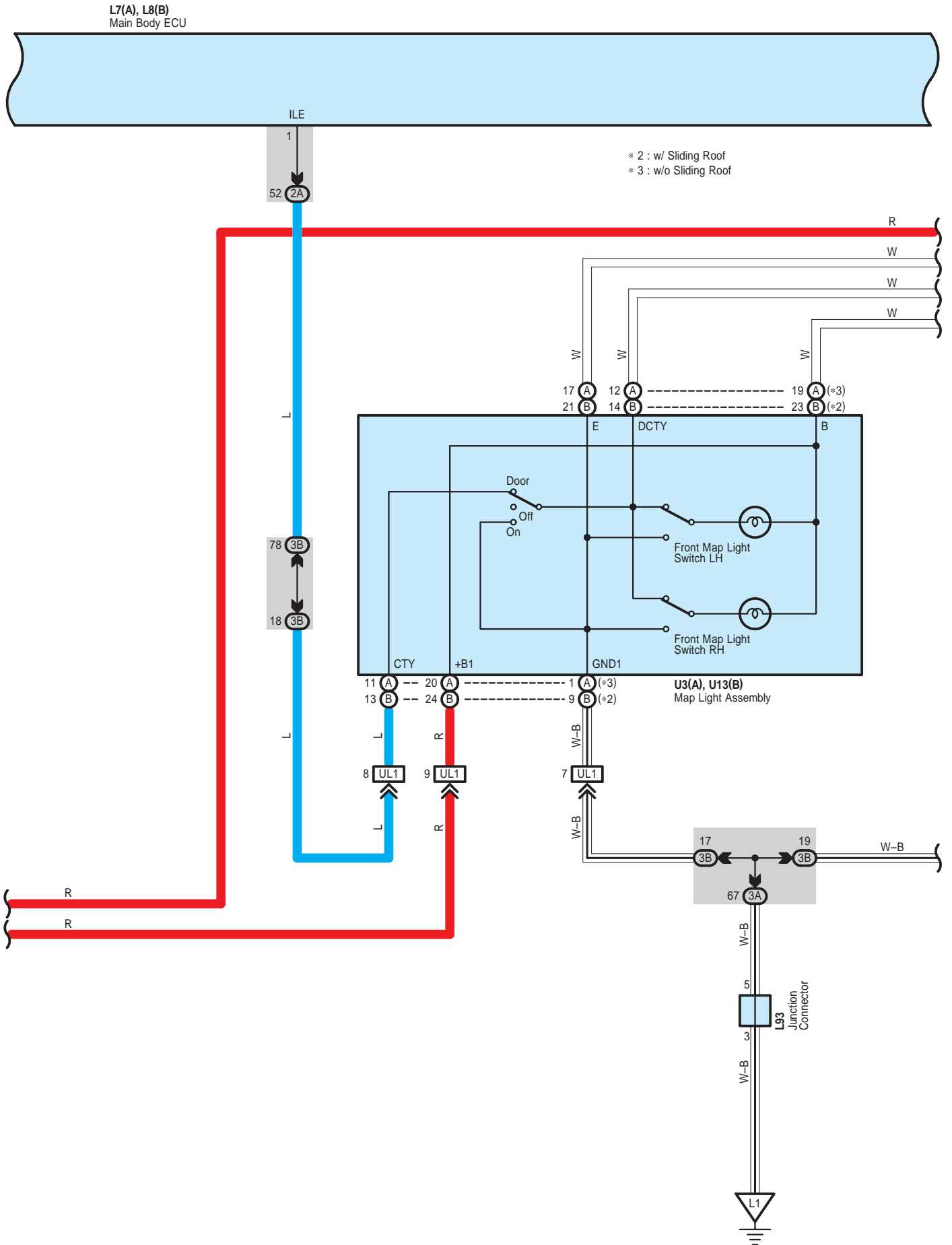

Interior Light

L7(A), L8(B)
Main Body ECU

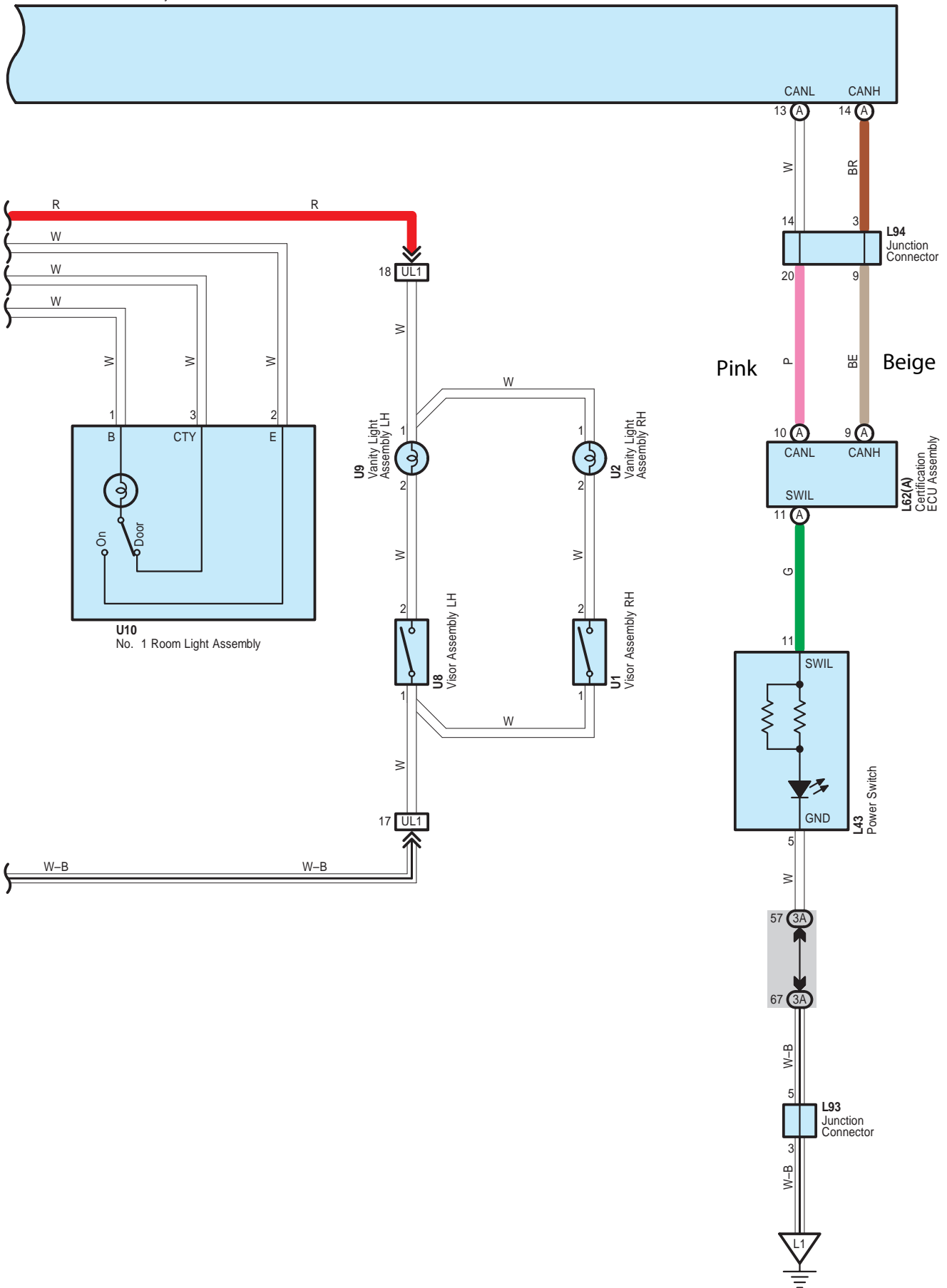

Interior Light

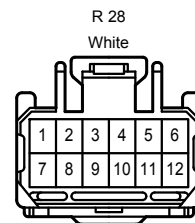
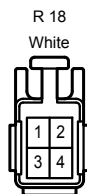
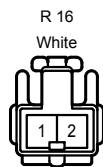
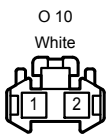
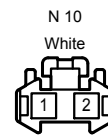
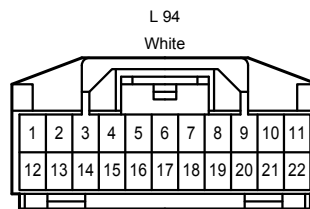
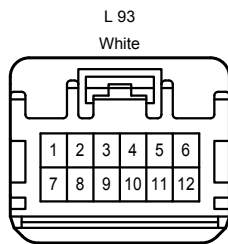
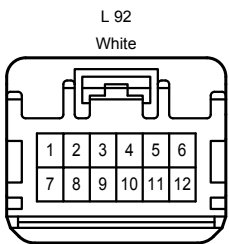
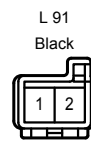
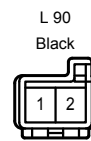
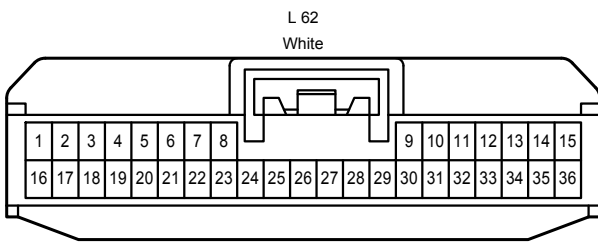
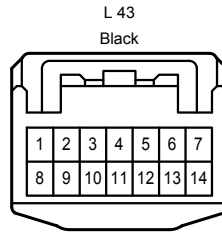
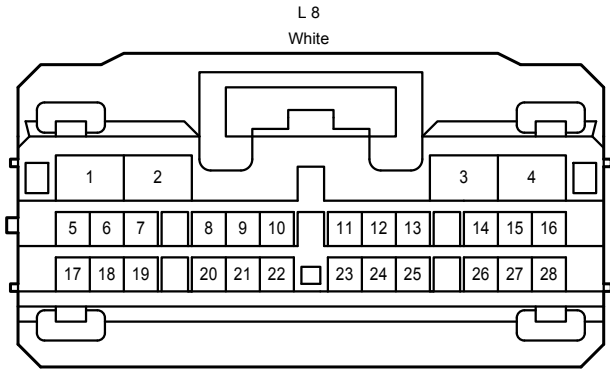
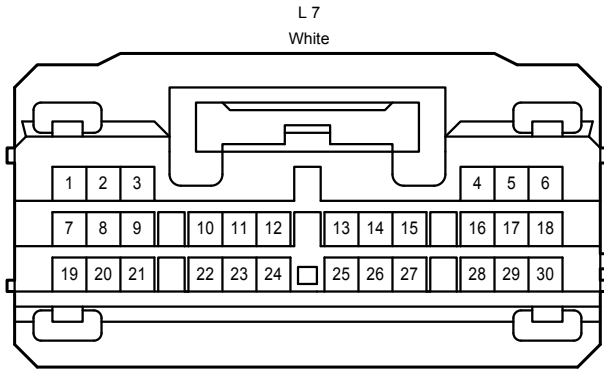

Interior Light

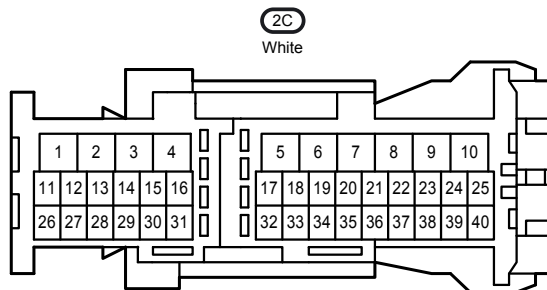
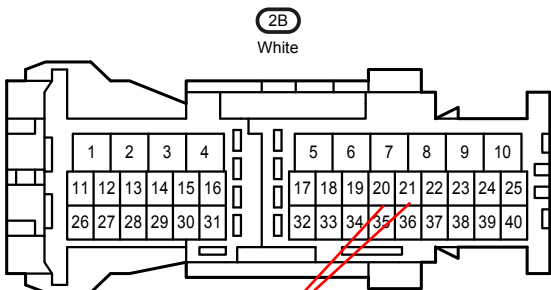
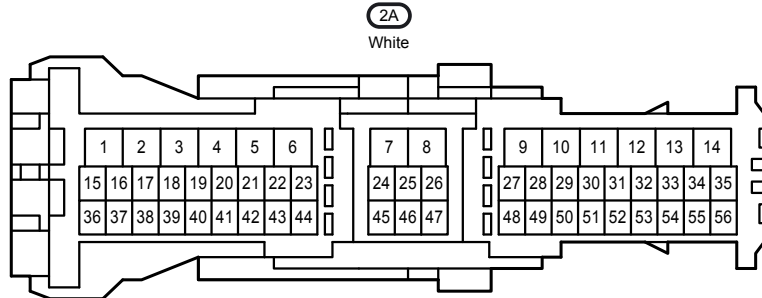
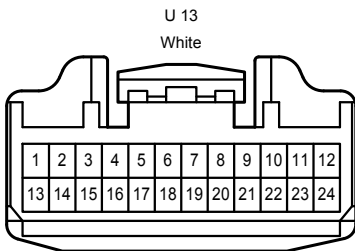
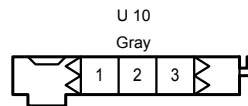
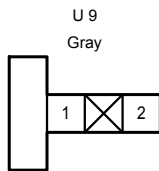
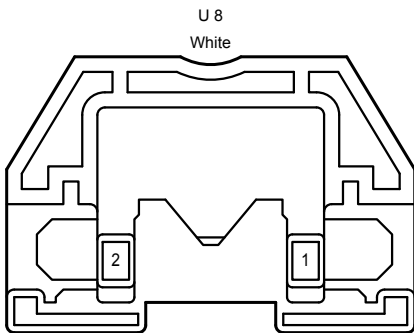
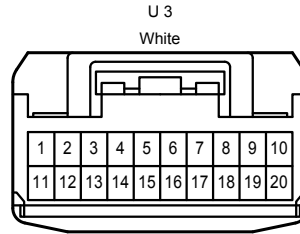
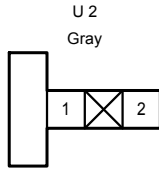
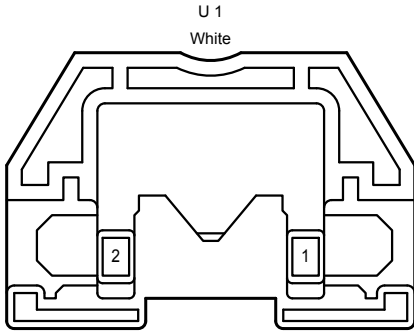
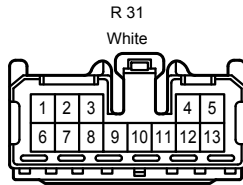
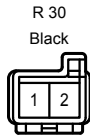
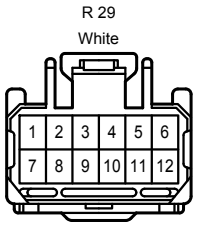

20 and 21 might be tapped into for footwell lights controlled by dome light circuit

Interior Light

2D
White

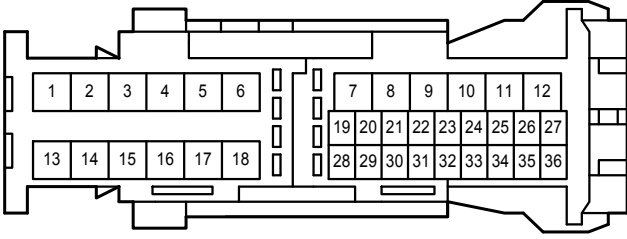

3A
White

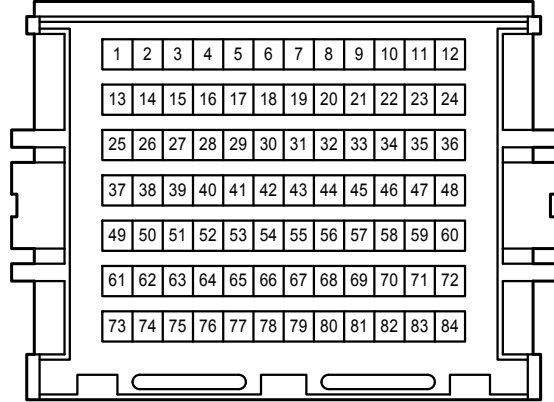

3B
White

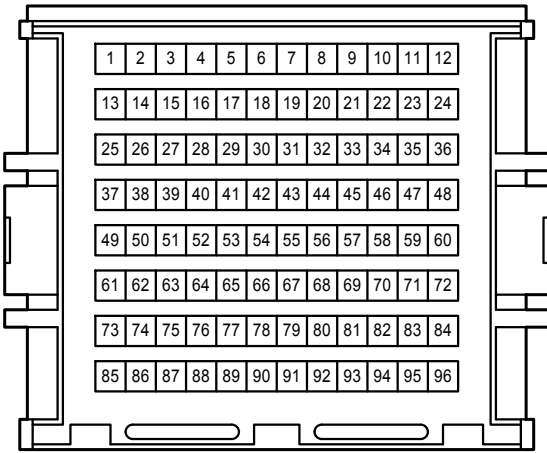

LR1
White

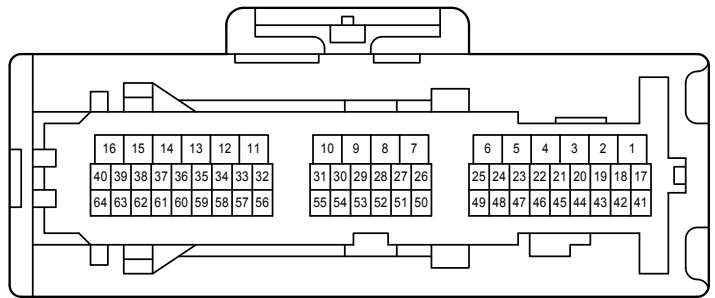
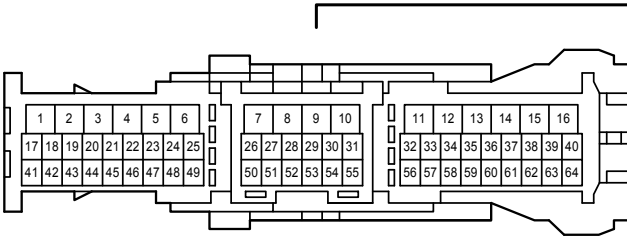

LS1
White

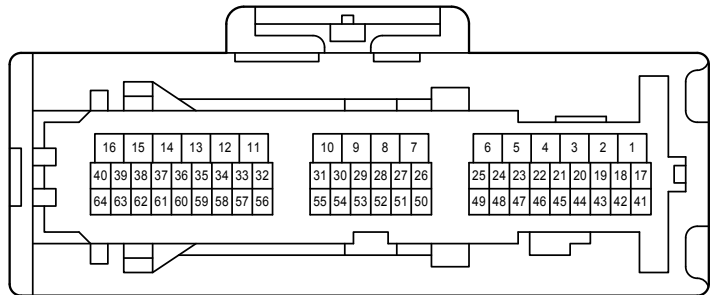
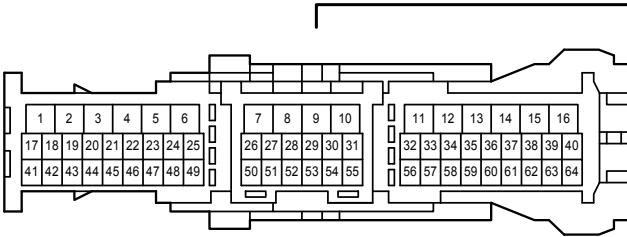

Interior Light

NL1
White

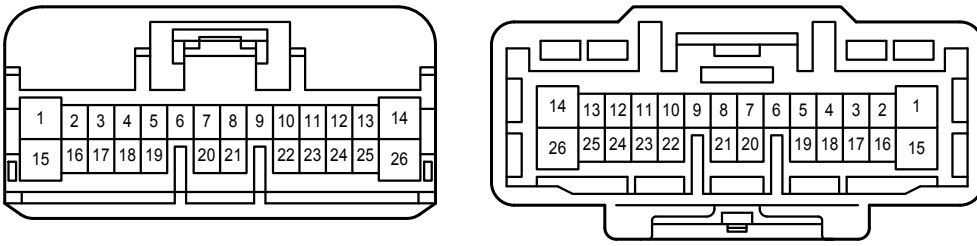

OL1
White

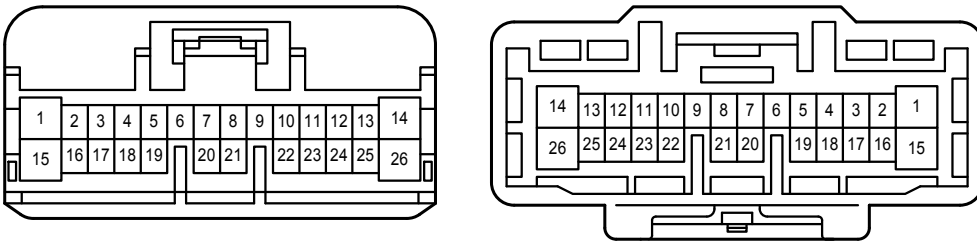

UL1
Gray

