

TECHNICAL INSTRUCTIONS
FOR
SAFETY RECALL D0H
BRAKE BOOSTER PUMP ASSEMBLY (ACCUMULATOR)
CERTAIN 2010 MODEL YEAR PRIUS

[Complete D0H Technical Video Supplement](#)

I. OPERATION FLOW CHART

The flow chart is for reference only. **DO NOT** use it in place of the full technical instructions. Follow **ALL** steps as outlined in the full technical instructions to confirm the campaign is completed correctly.

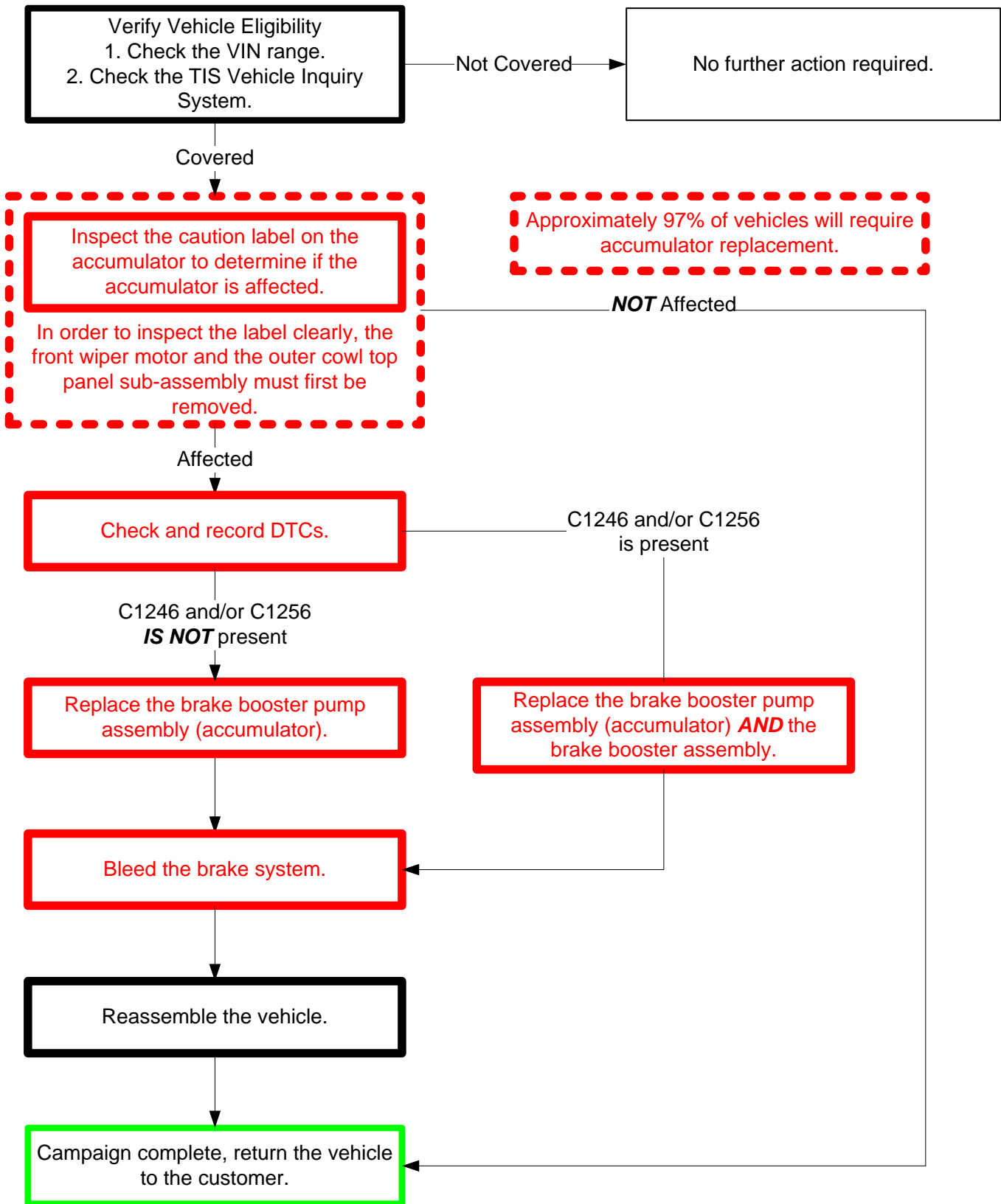

II. BACKGROUND

The subject vehicles are equipped with brake pressure accumulators consisting of a metal plunger containing brake fluid encased in a metal housing. The plunger is designed with metal pleated bellows to allow for motion. Nitrogen gas is sealed between the plunger and housing. There is a possibility that a fatigue crack could develop in the bellows due to the vertical vibration of the plunger while driving. If this occurs, nitrogen gas could leak into the brake fluid and gradually cause the brake pedal stroke to become longer, resulting in decreased hydraulic pressure. Under certain circumstances, this condition could affect stopping distance and increase the risk of a crash.

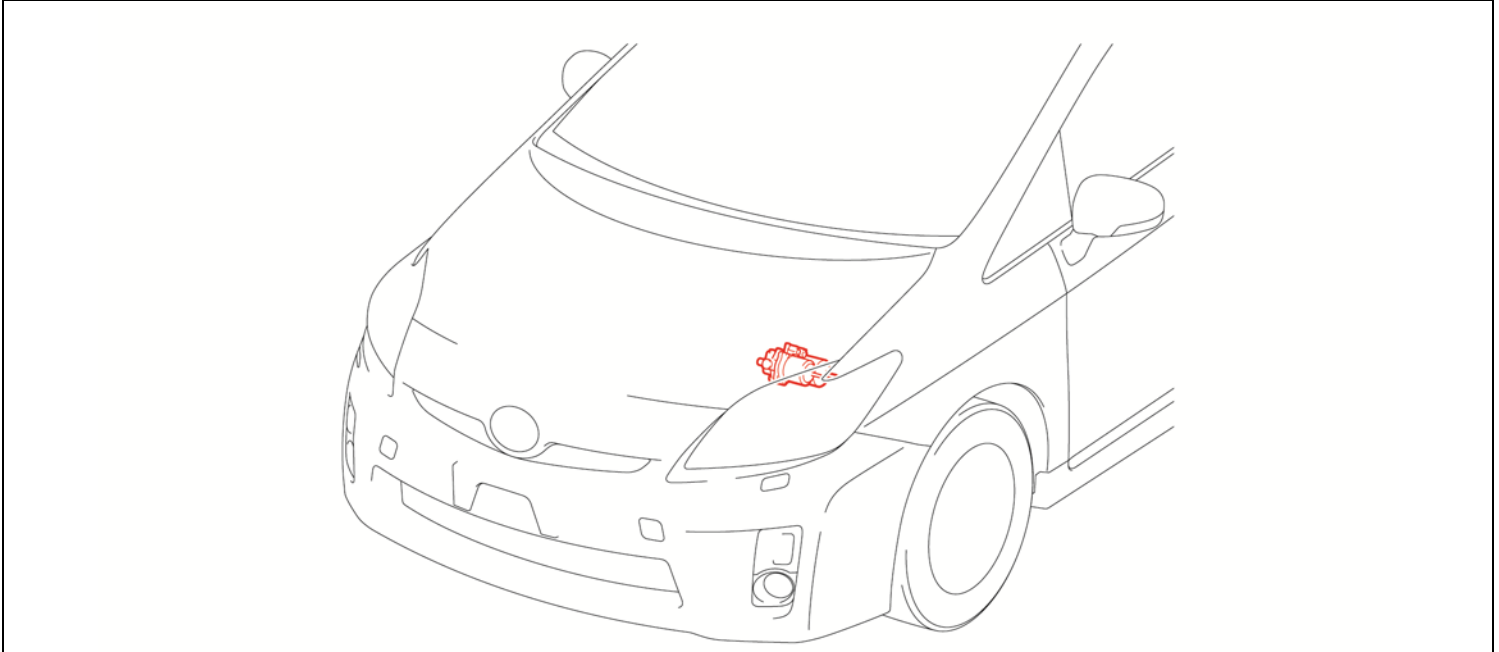

III. IDENTIFICATION OF AFFECTED VEHICLES

A. COVERED VIN RANGE

WMI	Year	VIN Range	
		VDS	Range
JTD	2010	KN3DU	0001044-0067875
			1000089-1092031
			5000051-5076070

NOTE:

- Check the TIS Vehicle Inquiry System to confirm the VIN is involved in this Safety Recall, and that the campaign has not already been completed prior to dealer shipment or by another dealer.
- TMS warranty will not reimburse dealers for repairs conducted on vehicles that are not affected or were completed by another dealer.

IV. PREPARATION

A. PARTS

The majority of vehicles (approximately 97%) will require the replacement of this part.

Part Number	Part Description	Quantity
04002-20247	Pump Assy, Brake Booster w/Accumulator Kit*	1
*The kit above includes the following parts.		
47070-47060	Pump Assy, Brake Booster w/Accumulator	1

Only a very small number of vehicles will require the replacement of this part, follow the inspection procedure in these instructions to determine if replacement is required. Parts will be on MAC, refer to the dealer letter for details.

Part Number	Part Description	Quantity
47050-47140 OR 47050-47150	Cylinder Assembly, Brake Master with Fluid	1
44785-02060	Brake Booster Gasket	1
90468-16142 OR 90468-07027	Clip	1

B. MATERIALS

- DOT3 brake fluid: approximately 2 liters for accumulator replacement (4 liters if also replacing master cylinder)

C. TOOLS & EQUIPMENT

- Standard hand tools
- Torque wrench
- Protective tape
- Molding remover set
- Techstream
- Paper towels

SST – This is an essential special service tool that the dealership should have.

Part Number	Part Name
00002-02955	Beam Torque Wrench

CAMPAIGN TOOLS – These tools are provided to the dealership. These tools are necessary when performing this repair.

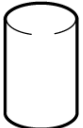
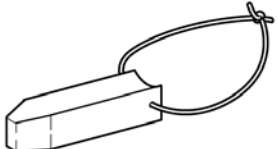
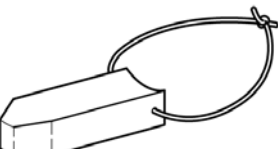
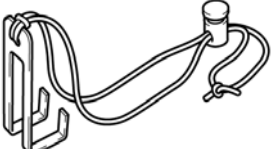
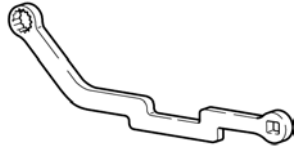

Image	Name	Quantity
	Rubber Caps	3
	Tube Remover (Small)	1
	Tube Remover (Large)	1

Image	Name	Quantity
	Bushing Holder	1
	Pump Wrench	1
	Nut Installer	1

NOTE: These tools **CANNOT** be ordered through the parts or tools system. There is a very limited supply of tools, but if additional tools are needed, contact your regional representative.

V. SAFETY PRECAUTIONS



CRITICAL INFORMATION – READ THOROUGHLY



These cautions should be observed when performing this campaign. Failure to follow these cautions could result in damaged parts or inadequate repair quality.

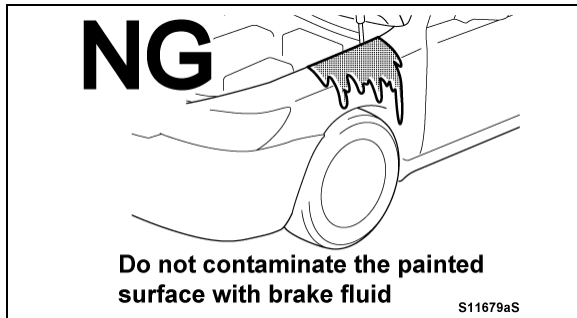

1. HANDLE BRAKE FLUID CAREFULLY

- DO NOT** allow brake fluid to contact any painted surfaces or the paint may be damaged.
- ALWAYS** use paper towels when disconnecting and reconnecting brake lines to prevent spillage.



2. DO NOT USE CLOTH RAGS OR GLOVES

- DO NOT** use any fabric near the open brake system components to avoid threads and fibers from entering the braking system.

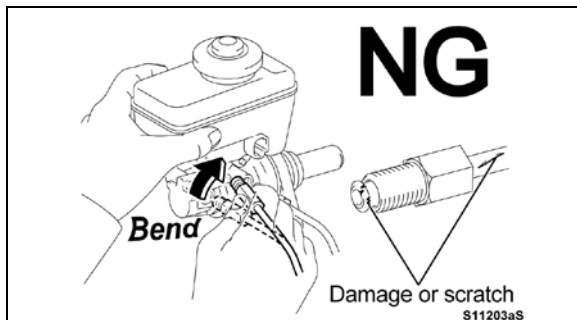

3. HANDLE THE BRAKE TUBES CAREFULLY

- DO NOT** deform or damage the brake tubes during removal or installation.

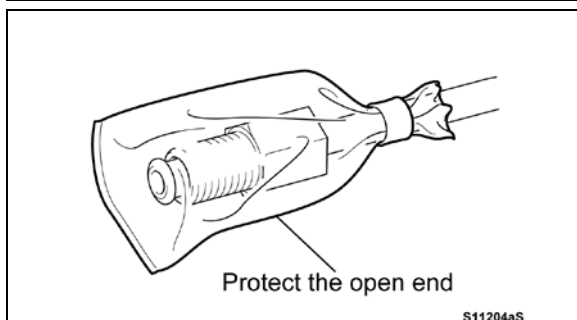

4. PROTECT THE BRAKE SYSTEM

- Clean components prior to disassembly to avoid contamination.
- Cover open components to avoid contamination.

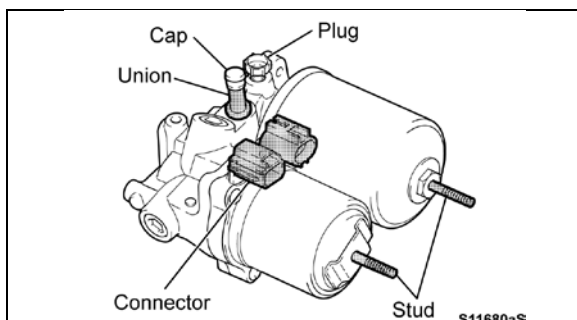

5. HANDLE BRAKE BOOSTER CAREFULLY

- If the new accumulator is dropped, **DO NOT** use.
- To avoid damage, **DO NOT** carry the accumulator by the union, connectors, or studs.
- The new accumulator is filled with brake fluid, **DO NOT** remove the plugs until installed.

VI. COMPONENTS

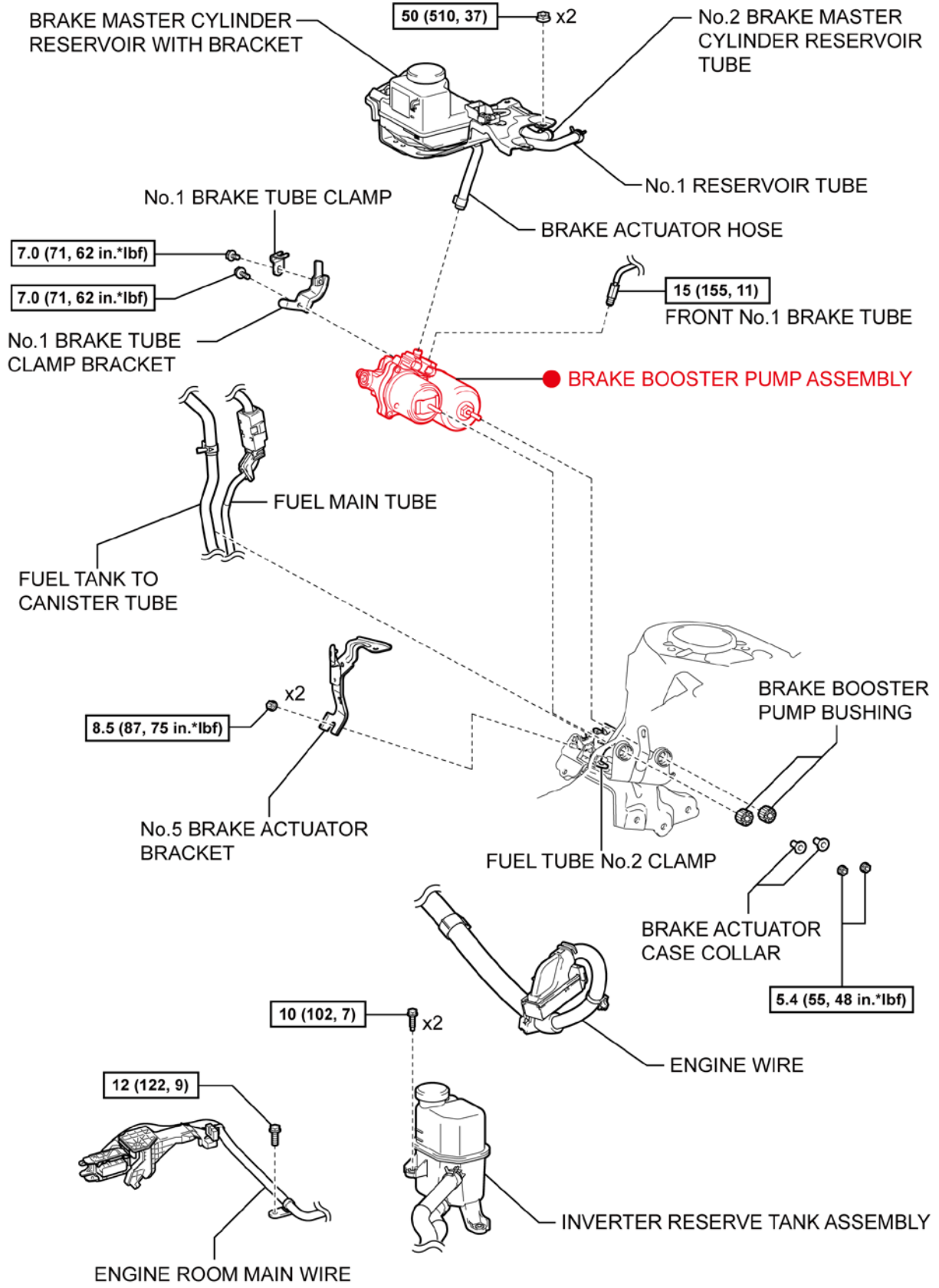

● Component to be replaced

N*m (kgf*cm, ft.*lbf) : Specified torque

S11143aS

VII. ACCUMULATOR CAUTION LABEL INSPECTION

[Video Supplement: Introduction & Inspection](#)

1. REMOVE THE FRONT WIPER MOTOR AND OUTER COWL TOP PANEL SUB-ASSEMBLY

a) Refer to [TIS](#) for removal instructions.

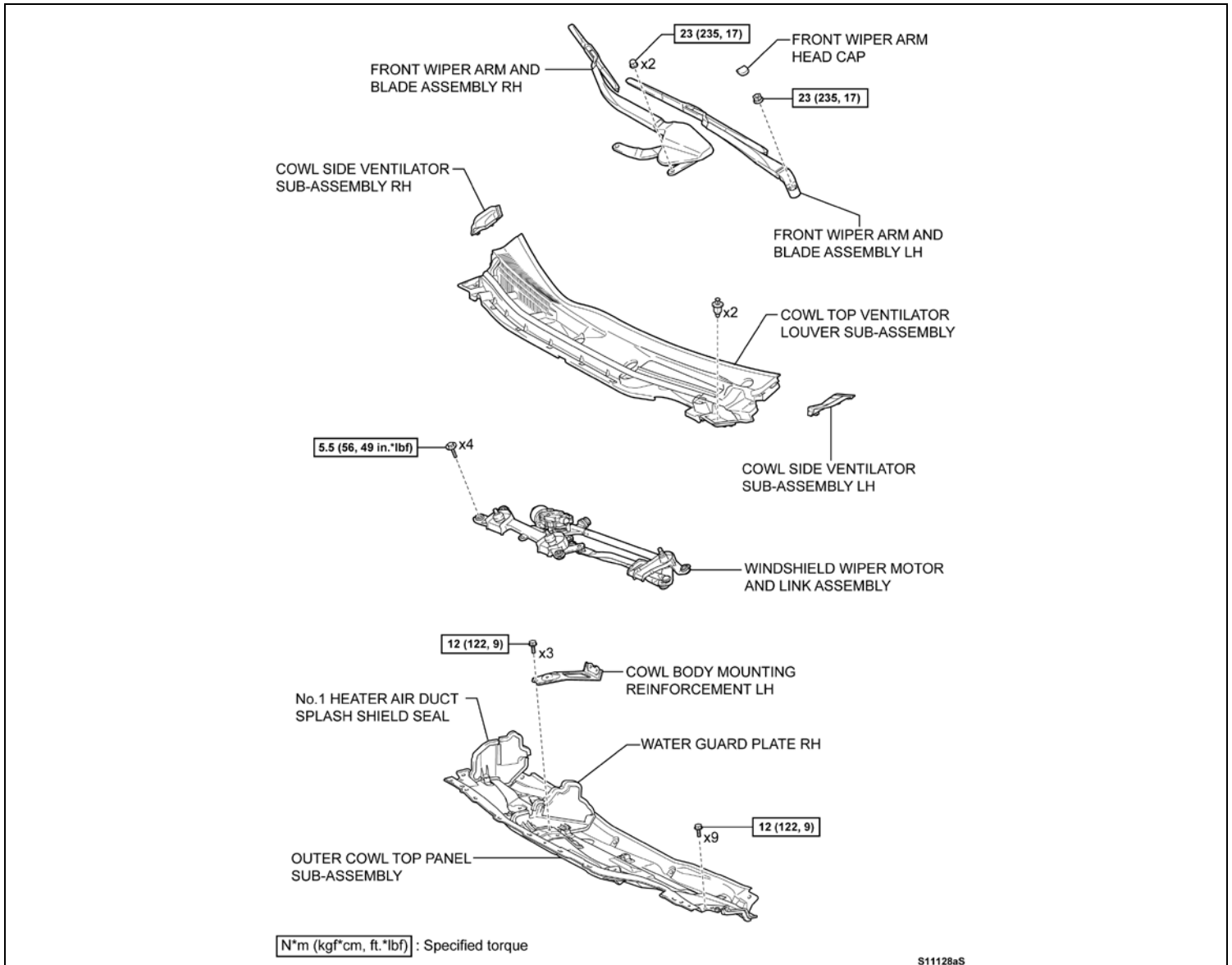

Always pull the louver down to disengage it from the windshield prior removing it. If the louver is pulled upward before disengaging it from the windshield the windshield may crack

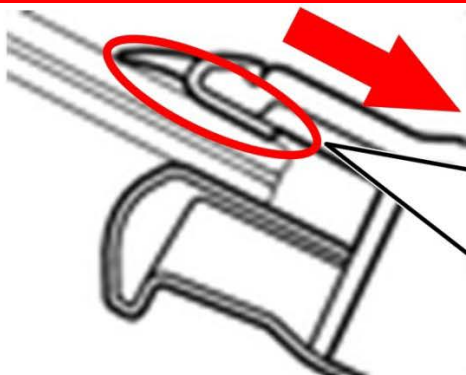

2. INSPECT THE ORIENTATION OF THE ACCUMULATOR CAUTION LABEL

a) Inspect the orientation of the caution label to determine if the accumulator requires replacement.

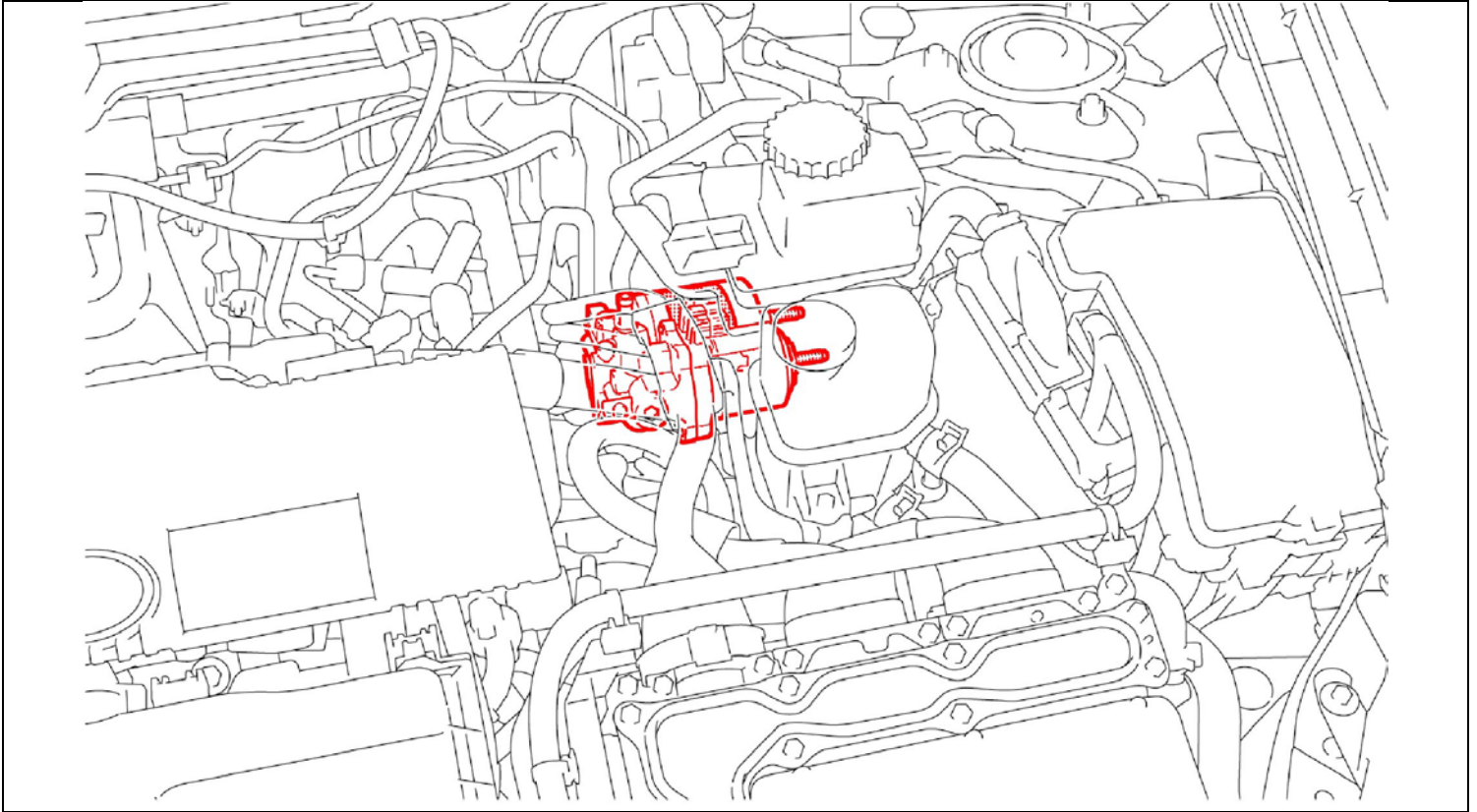

CONDITION 1

Label is **HORIZONTAL** on accumulator
Accumulator replacement **REQUIRED**

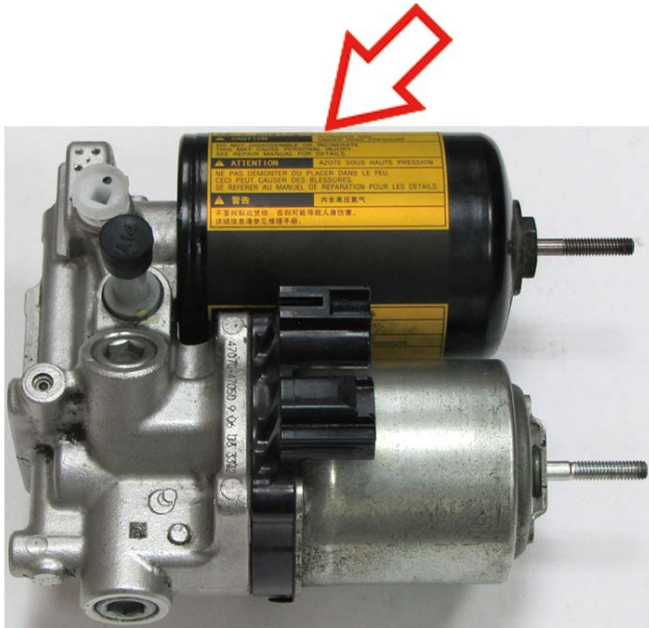

The accumulator is affected and replacement is required. Proceed to **STEP 3**. To determine if additional parts require replacement.

CONDITION 2

Label is **VERTICAL** on accumulator
NO NEED to replace accumulator

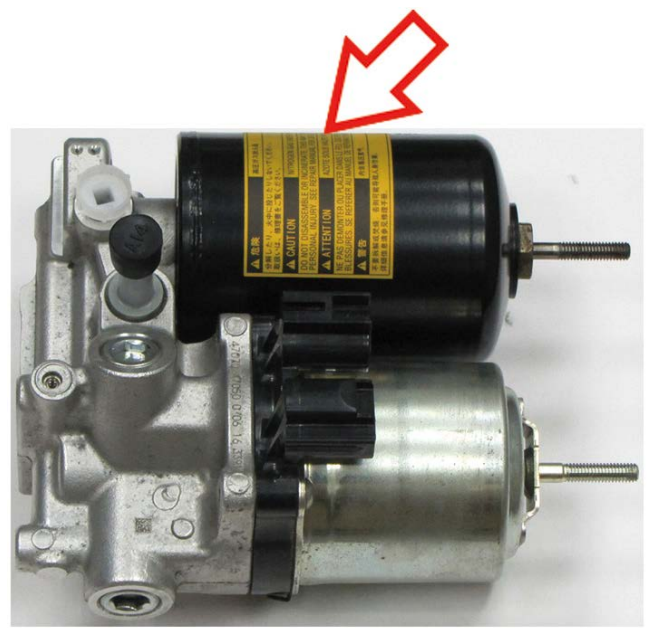

The accumulator **IS NOT** affected and **DOES NOT** need to be replaced. Reassemble the vehicle. Campaign complete.

NOTE: There is only a small percentage of vehicles that will not require accumulator replacement.

3. CHECK AND RECORD DTCs

- a) Check and record any DTCs.

CONDITION 3

C1246 and/or C1256 was found during DTC inspection step.

The accumulator may have potentially leaked nitrogen gas into the brake booster assembly; therefore, the Brake booster assembly must also be replaced.

Replace the brake booster assembly as per the repair manual when replacing the accumulator. Proceed to **SECTION VIII.**

CONDITION 4

C1246 AND C1256 WERE NOT found during DTC inspection step.

ONLY accumulator replacement is required. Proceed to **SECTION VIII.**

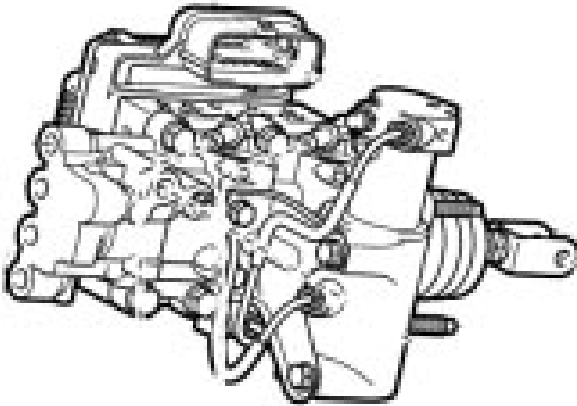

**BRAKE BOOSTER
ASSEMBLY**

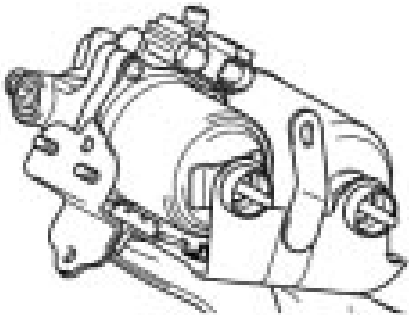

**BRAKE BOOSTER PUMP
ASSEMBLY (ACCUMULATOR)**

VIII. ACCUMULATOR REMOVAL

[Video Supplement: Accumulator Removal](#)

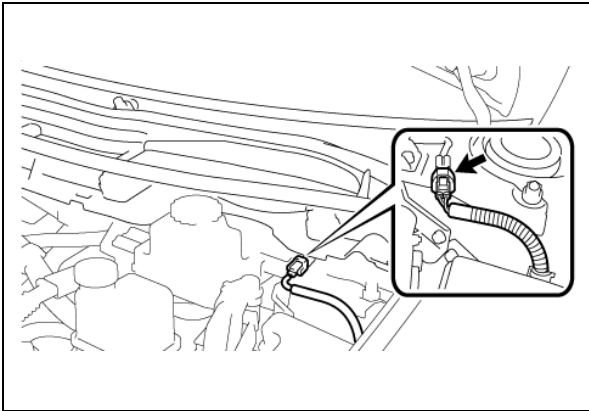

1. DISABLE THE BRAKE CONTROL SYSTEM

- Turn the IG OFF and apply the parking brake.
- Wait 2 minutes.



- It takes 2 minutes for the brake control system to become disabled. **DO NOT** proceed to the next step until 2 minutes have elapsed or air may enter the brake system when the battery is reconnected.
- DO NOT** operate the brake pedal or any doors while waiting for the 2 minutes to elapse.

- Disconnect the reservoir level switch connector.

2. DISCONNECT THE NEGATIVE BATTERY CABLE

- Disconnect the battery cable.



- DO NOT** reconnect the battery until instructed or air could enter the accumulator and damage the pump.

NOTE: The luggage door may lock when the battery is disconnected.

3. RELEASE THE PRESSURE FROM THE ACCUMULATOR

- Depress the brake pedal 40 times or more to discharge all internal pressure from the accumulator.

NOTE: The brake pedal should become very stiff.

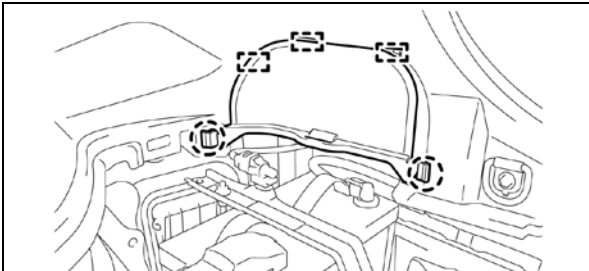

4. REMOVE THE SERVICE PLUG

- Refer to [TIS](#) for removal instructions.

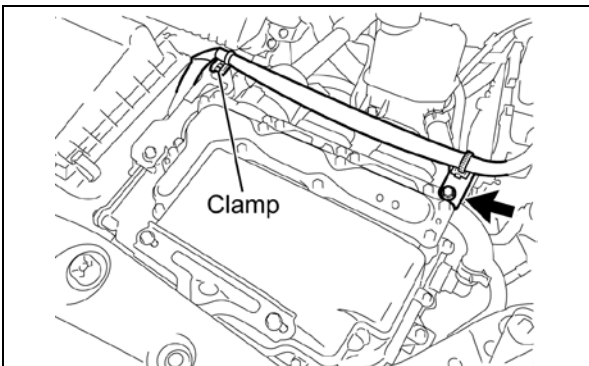

5. SEPARATE INVERTER RESERVE TANK ASSEMBLY

- Disengage the clamp.
- Remove the bolt to detach the engine room main wire.

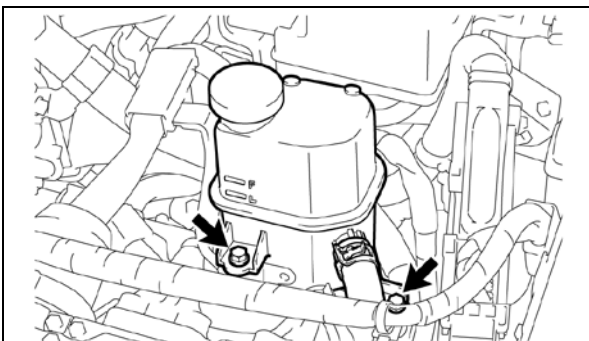

- Remove the 2 bolts and detach the inverter reserve tank.

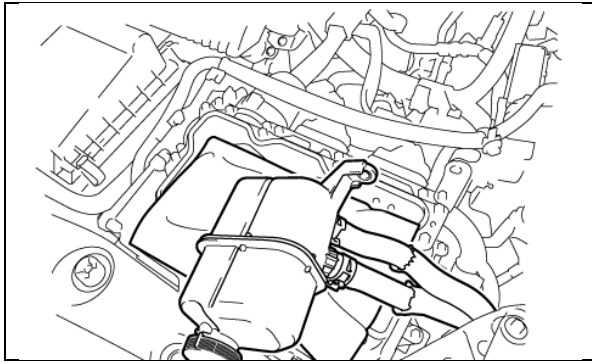

- d) Place paper towels over the inverter, then place the inverter reservoir on top of the reservoir.

NOTE: DO NOT strain the hoses.

6. REMOVE BRAKE FLUID

- a) Remove some brake fluid from the reservoir to prevent spillage.



- **DO NOT** use a fluid extractor that has been used on anything other than brake fluid to avoid contamination.
- **DO NOT** allow brake fluid to contact any painted surfaces.

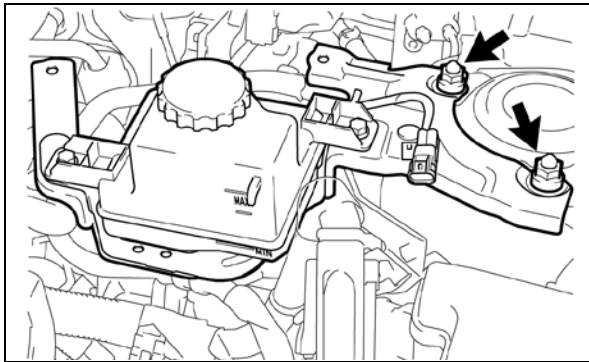

7. DISCONNECT THE MASTER CYLINDER RESERVOIR WITH BRACKET

- a) Remove the 2 nuts and detach the reservoir with bracket.

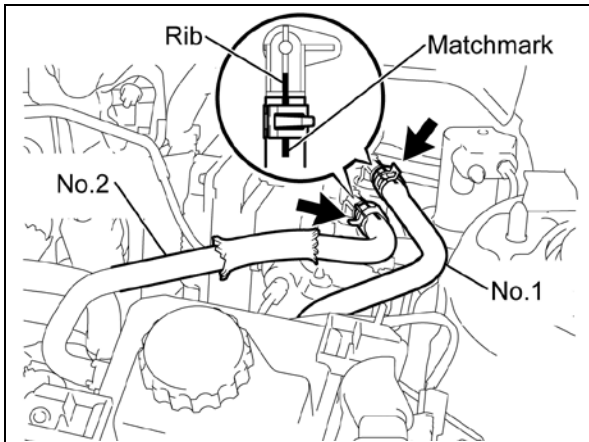

8. DISCONNECT THE No.1 RESERVOIR AND No.2 BRAKE MASTER CYLINDER RESERVOIR TUBES

- a) Place matchmarks on the tubes that align with the ribs on the booster. These will be used during reassembly.

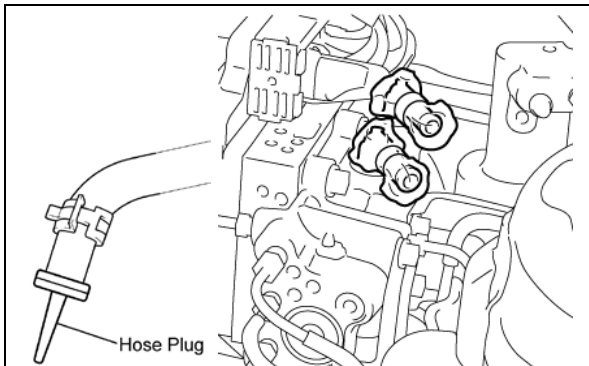

- b) Disconnect and immediately plug the hoses.
c) Cover the lines on the booster to prevent contamination.

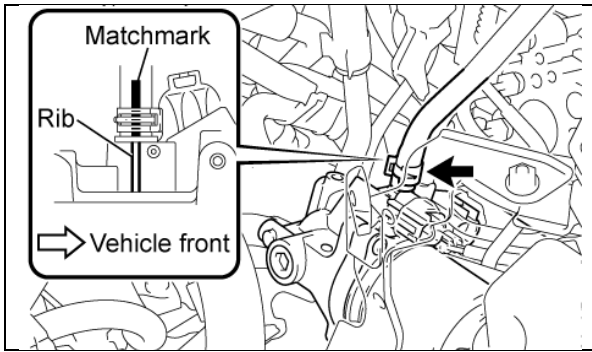

9. DISCONNECT THE BRAKE ACTUATOR HOSE

- a) Place a matchmark on the hose that aligns with the rib on the accumulator. This will be used during reassembly.
- b) Disconnect and immediately plug the hose.

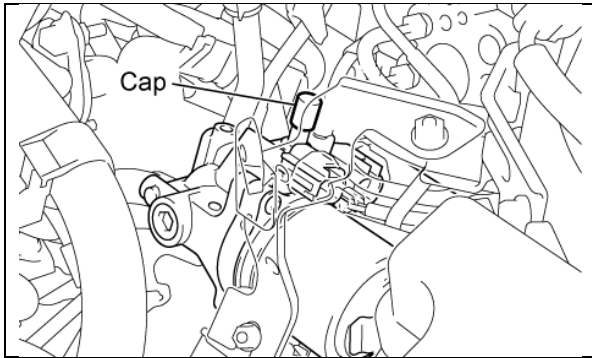

- c) Plug the line of the accumulator with the cap that was supplied in the tool kit.

10. COMPLETELY REMOVE THE BRAKE MASTER CYLINDER RESERVOIR WITH BRACKET

11. REMOVE THE No.5 BRAKE ACTUATOR BRACKET

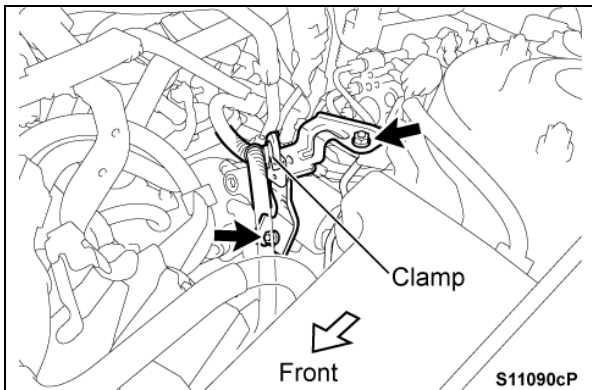

- a) Disengage the clamp.
- b) Remove the 2 nuts and the bracket.

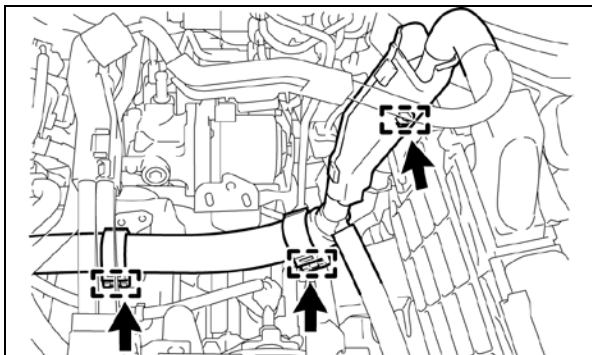

12. DISCONNECT THE ENGINE HARNESS

- a) Disconnect the 3 clamps.

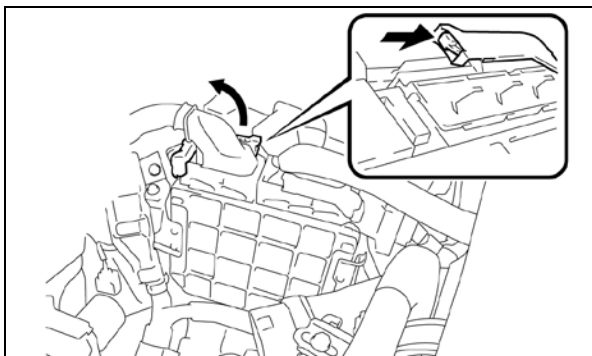

- b) Press the lock on the lever and lift to disconnect the hybrid vehicle control ECU connector.

NOTE: DO NOT allow moisture or debris to contaminate the open connectors.

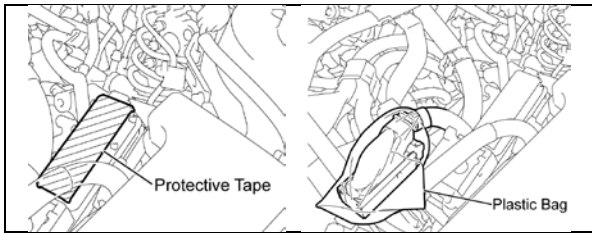

- c) Protect the ECU connector with tape.
- d) Protect the harness connector with a plastic bag.

13. SEPARATE THE FUEL LINES

- a) Press the small tube remover (campaign tool) against the main tube.
- b) Slide the remover into the clamp to disengage the clamp claw.
- c) Hold the remover and pull the tube from the clamp.
- d) Use the large tube remover (campaign tool) to separate the canister tube.

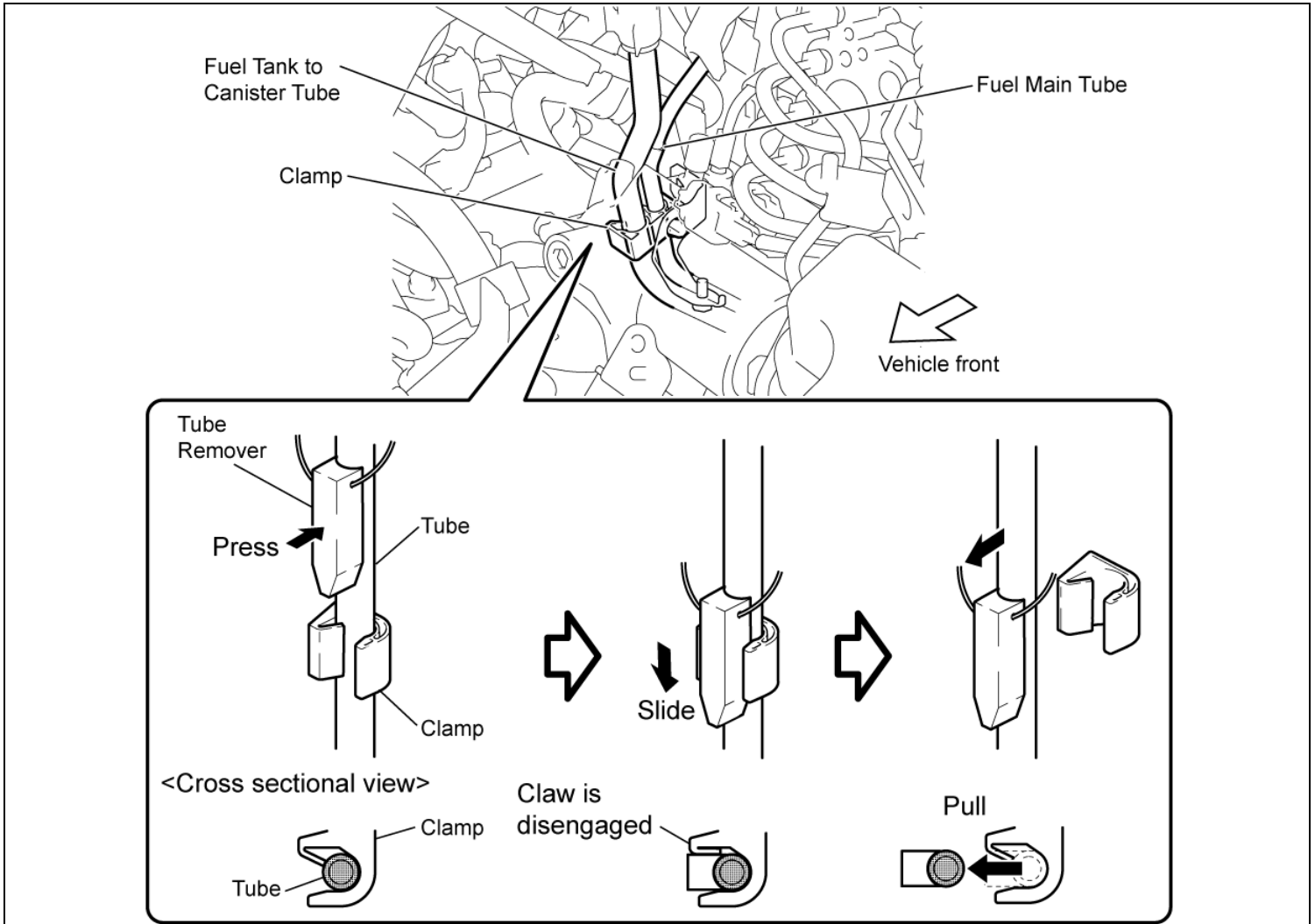

- e) Rotate the clamp 90 degrees to prevent the tubes from being engaged.

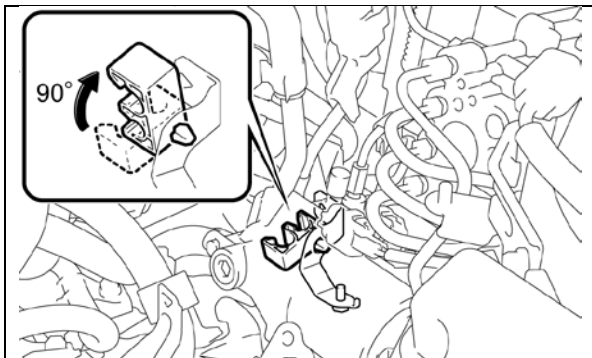

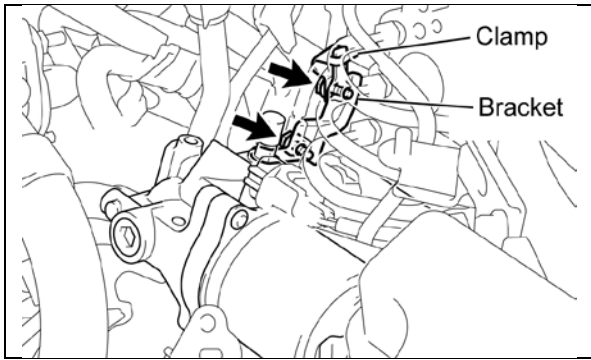

14. DISCONNECT THE FRONT No.1 BRAKE TUBE

- a) Remove the upper bolt to remove the clamp.
- b) Remove the lower bolt to remove the bracket.

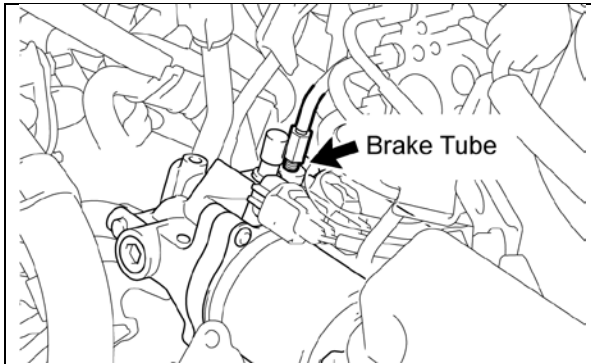

- c) Disconnect the brake tube from the accumulator.
- d) Place a bag over the tube to prevent contamination.

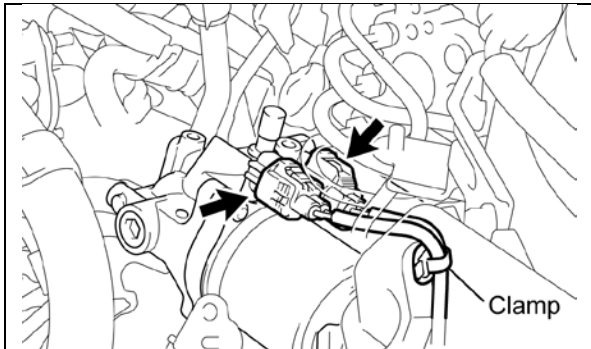

15. DISCONNECT THE ACCUMULATOR CONNECTORS

- a) Disconnect the 2 connectors.
- b) Disengage the clamp.

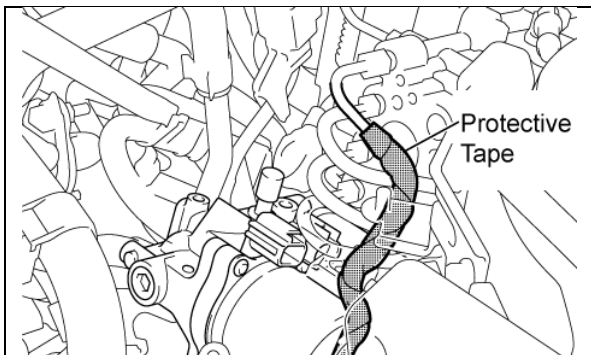

16. PROTECT THE BRAKE TUBE

- a) Wrap the brake tube to prevent damage during accumulator removal.

17. REMOVE THE ACCUMULATOR MOUNTING NUTS

- a) Use the brake pump wrench (campaign tool) to remove the 2 accumulator mounting nuts.



- Position the wrench under the harness to avoid damage.
- Use a magnet to retrieve the nuts after they are loosened to avoid losing them.

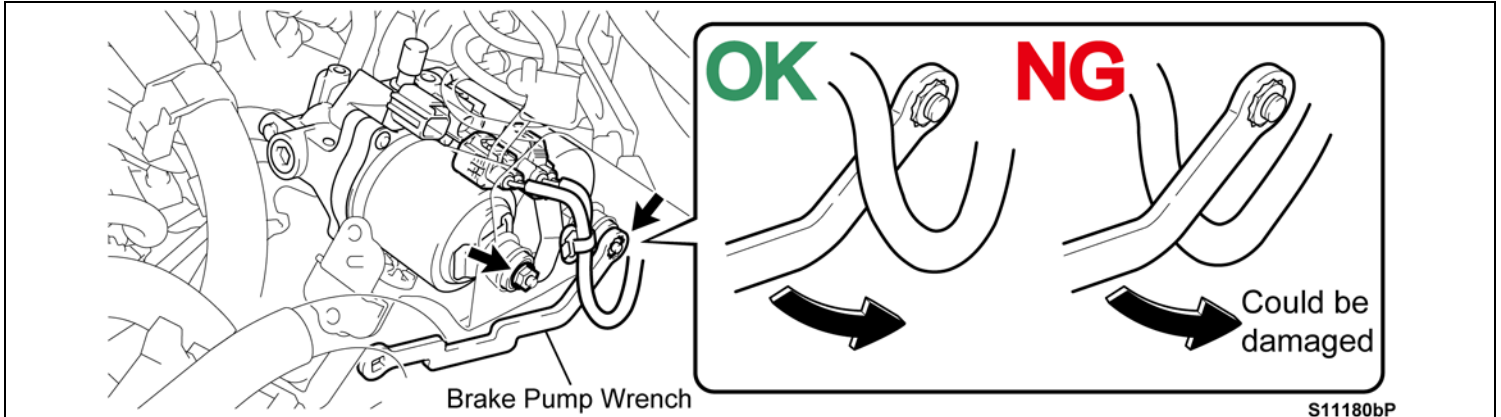

18. REMOVE THE MOUNTING BUSHINGS AND COLLARS

- a) Move the pump towards the right side of the vehicle to allow for the removal of the bushings and collars.
b) Remove the 2 bushings and 2 collars, then reposition the pump to its original place.

NOTE: Use a magnet to retrieve the collars to avoid losing them.

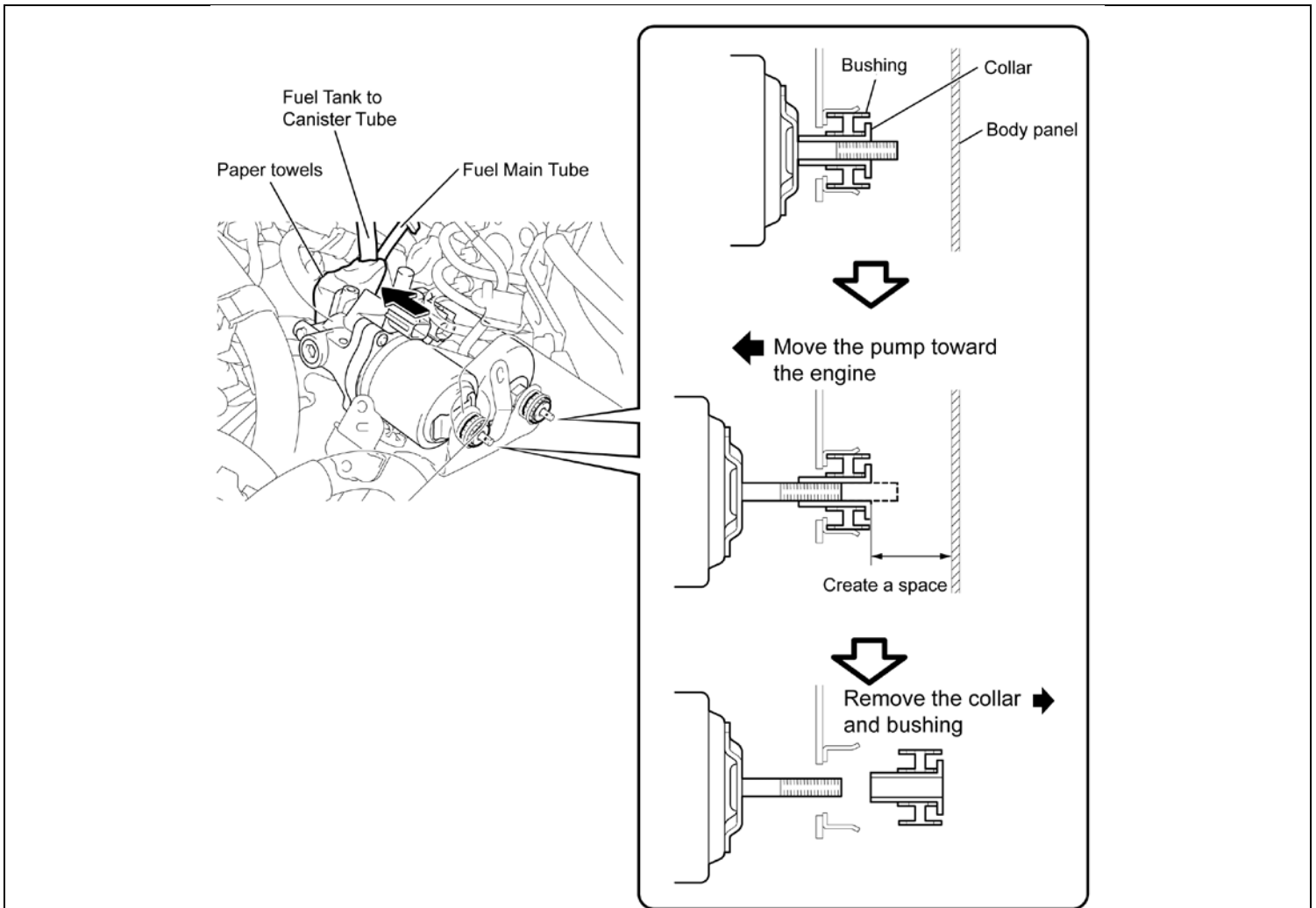

19. REMOVE THE ACCUMULATOR

a) Set the bushing holder (campaign tool) into place by following the directions on the illustration.

NOTE: If the bushing holder is not set correctly, the bushing and collar will fall off and may be lost.

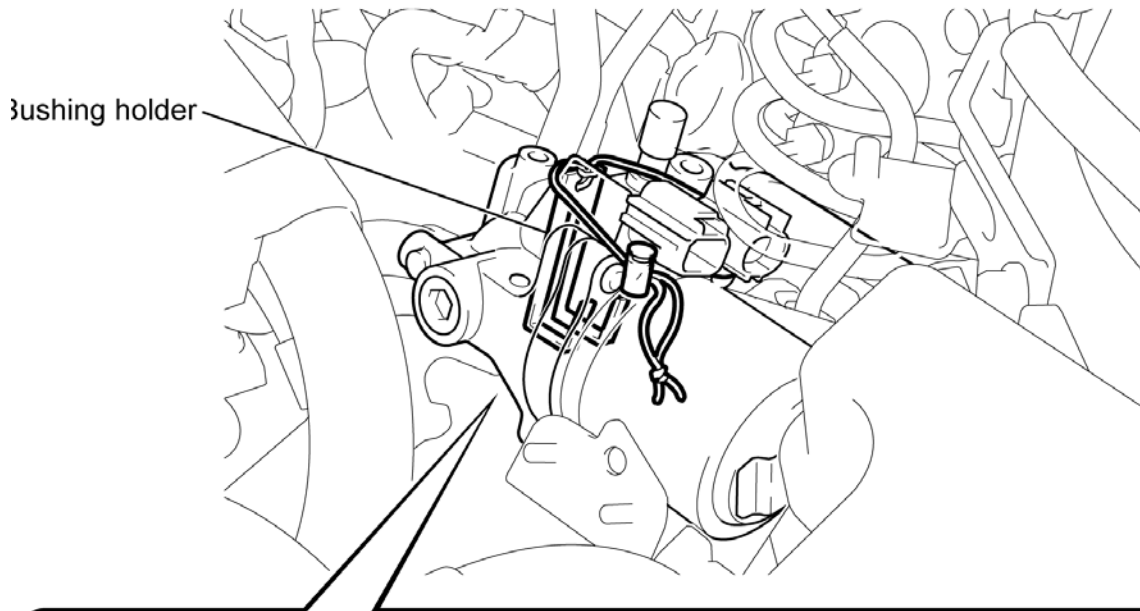

① Set a bushing holder as shown in the illustration.

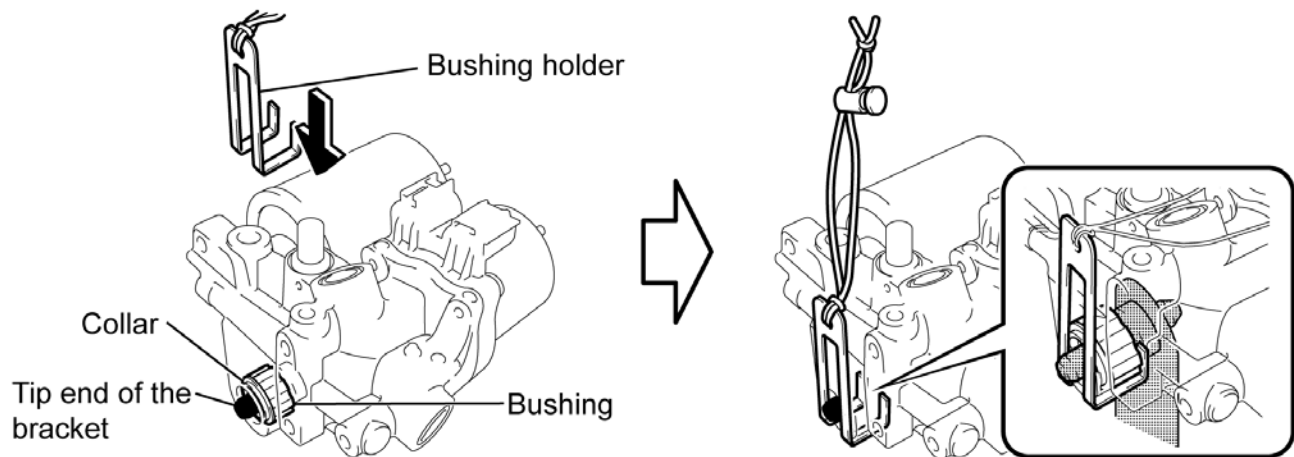

② Hook the loop of string at the connectors on the pump, and fix the holder with the stopper of the string.

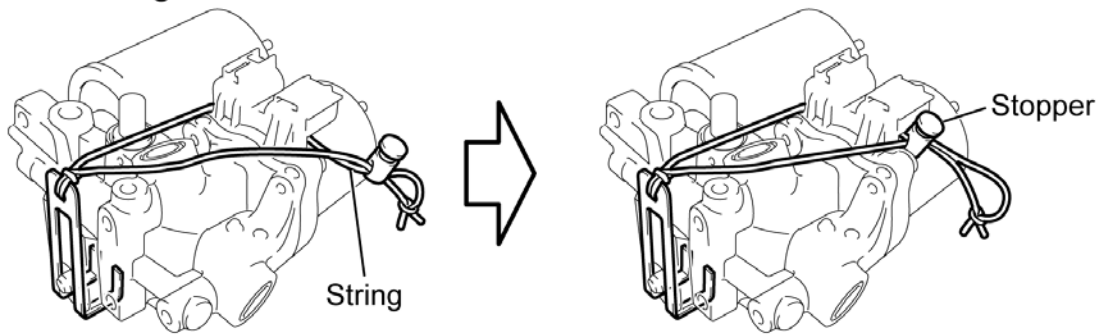

b) Remove the accumulator from the vehicle by following the directions on the illustration.



- To avoid damaging surrounding components, remove the pump carefully.
- Avoid disturbing the bushing holder string.

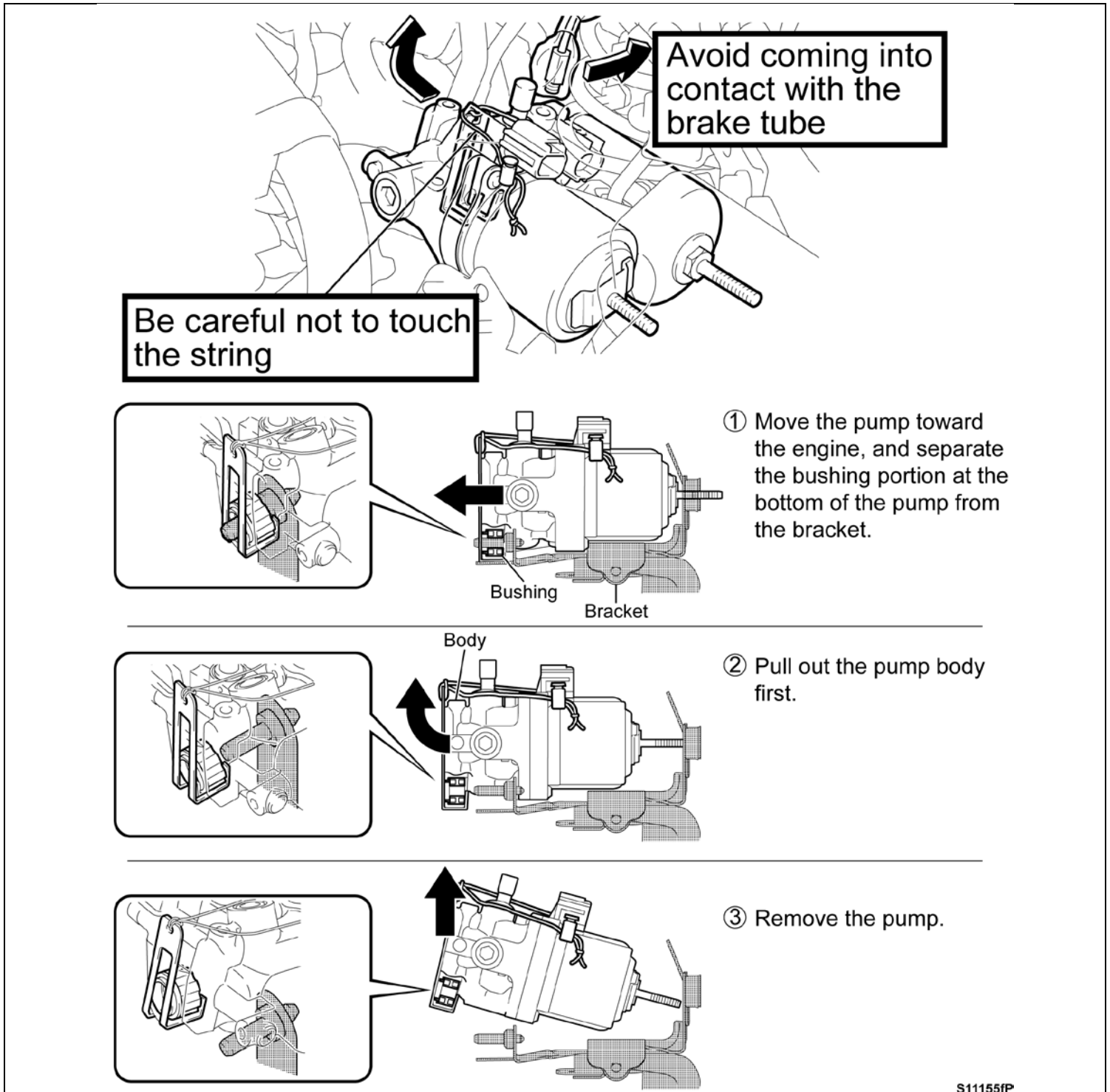

c) Remove the bushing holder.

d) Mark the old pump so it is not reused.

IX. ACCUMULATOR INSTALLATION

[Video Supplement: Accumulator Installation & Old Accumulator Disposal](#)

1. CONFIRM THE COLLAR AND BUSHING

- Confirm the bushing and collar (included with new part) are installed securely.

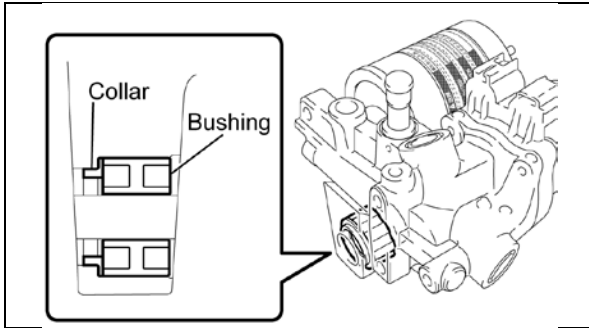

2. POSITION THE **NEW** PUMP IN THE BRACKET

- Position the **NEW** pump in the bracket by following the directions on the illustration.



- To avoid damaging surrounding components, install the pump carefully.
- If the new pump is installed incorrectly the bushing may be damaged, if too much resistance is felt during installation confirm the bushing is not damaged.

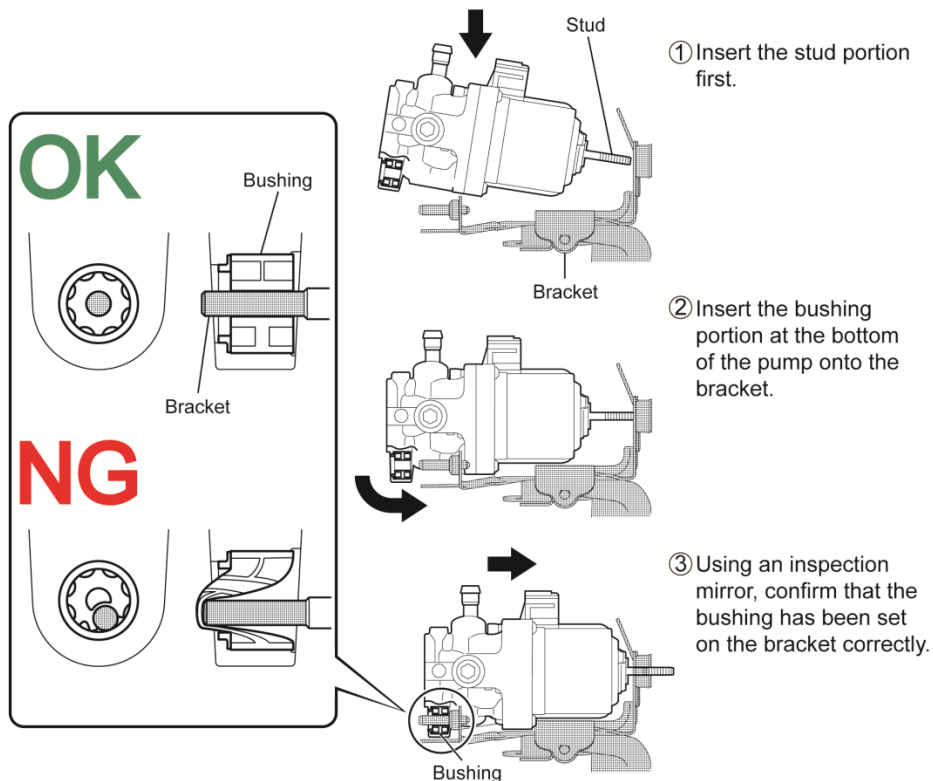
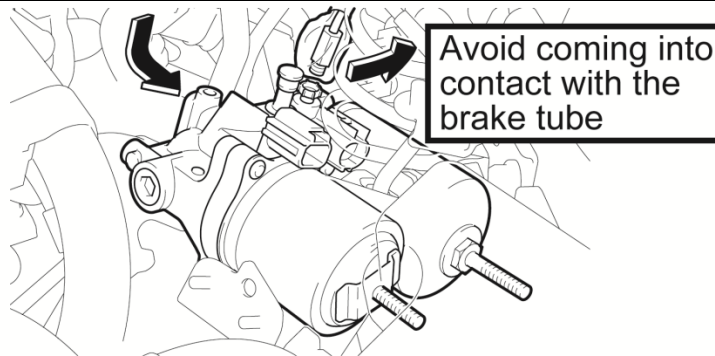

Move the pump toward the engine

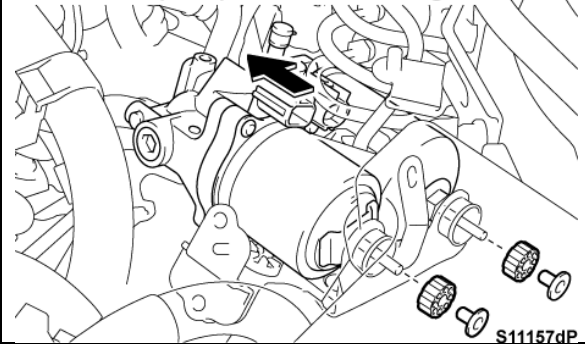

3. INSTALL THE BUSHINGS AND COLLARS

- a) Move the pump towards the right side of the vehicle to allow for the installation of the bushings and collars.
- b) Install the 2 bushings and 2 collars, then reposition the pump to its original place.

NOTE: To ease bushing and collar installation, follow these steps.

- 1) Slide to collar out of the bushing slightly.
- 2) Use a magnet to hold the bushing and collar.
- 3) Install the bushing and collar.

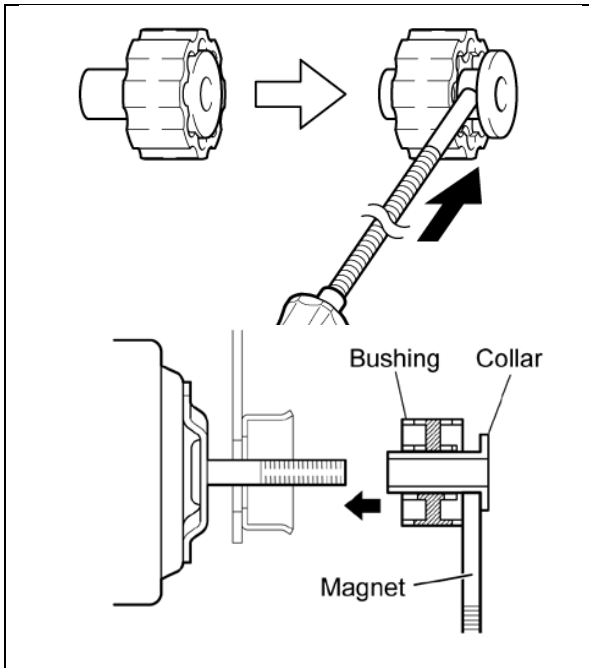

4. INSTALL THE ACCUMULATOR MOUNTING NUTS

- a) Use the nut holder (campaign tool) to loosely install the nut closest to the bulkhead.

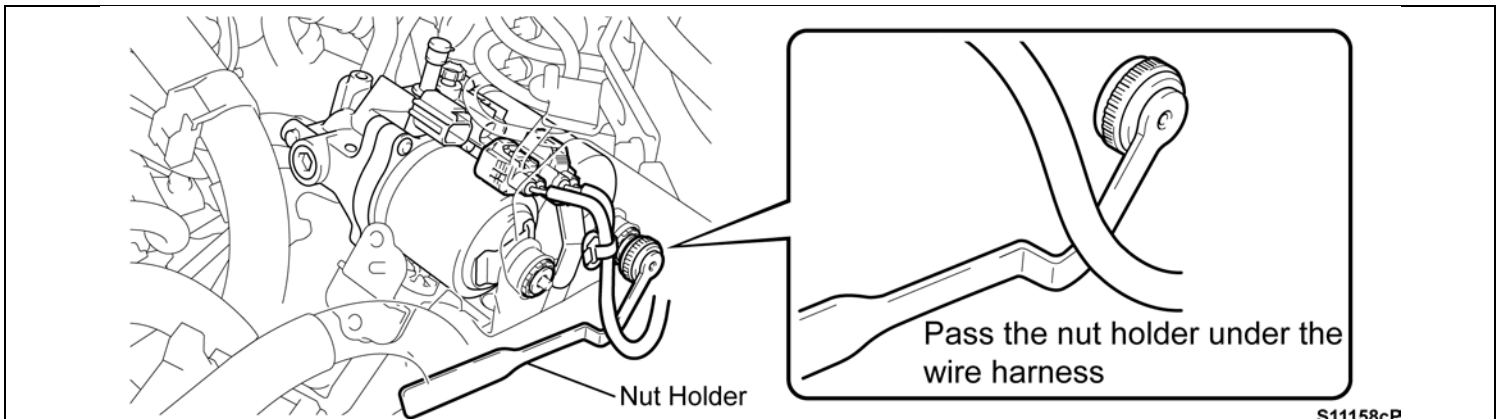

NOTE:

- Follow this illustration for instructions on how to use the nut holder.
- It may be necessary to press the accumulator towards the left side of the vehicle to ease installation of the nuts.

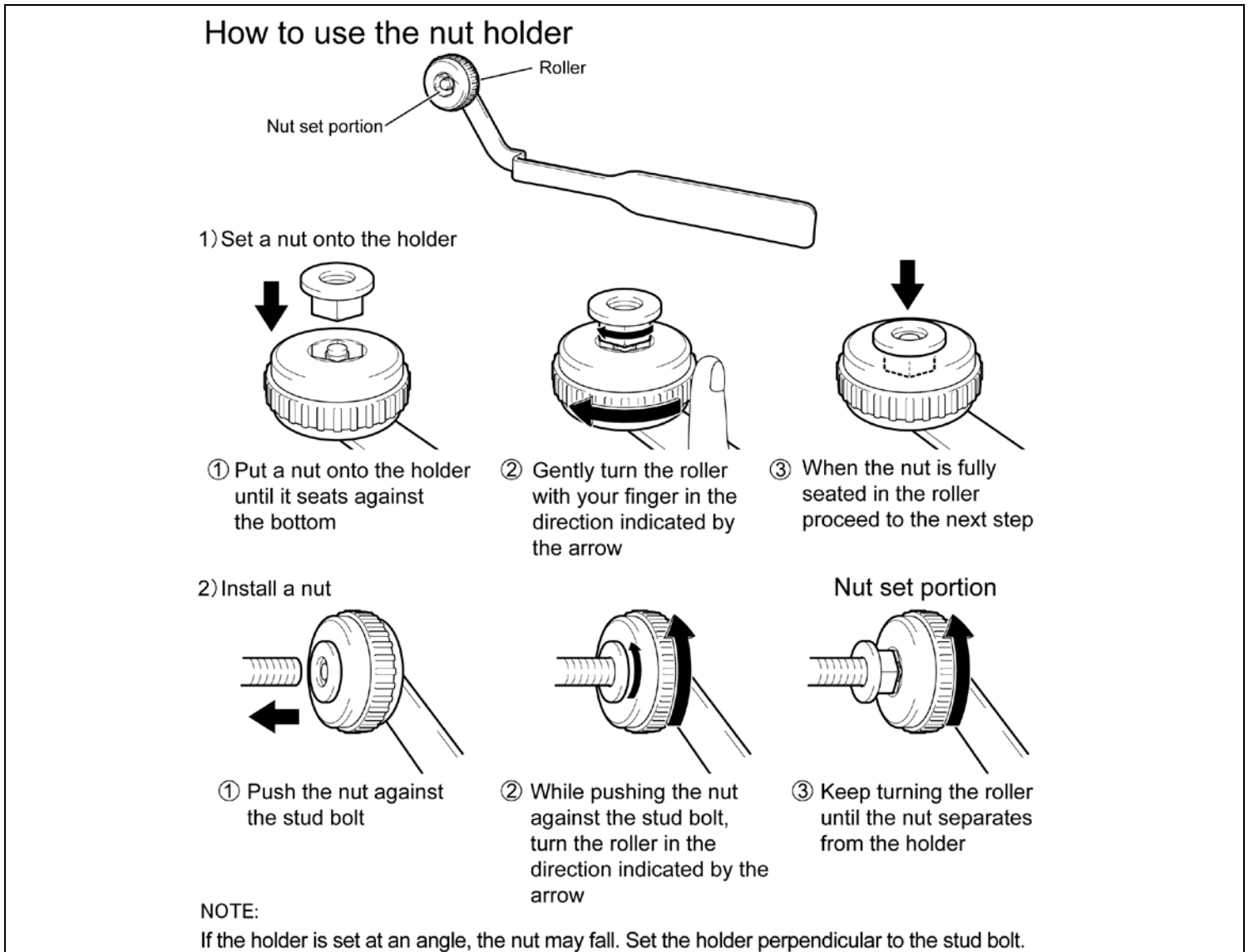

- b) Loosely install the nut towards the front of the vehicle by hand.
- c) Use the brake pump wrench (campaign tool) and beam torque wrench (SST 00002-02955) to torque the 2 nuts.

Torque: 31in. lbf (3.5N·m)

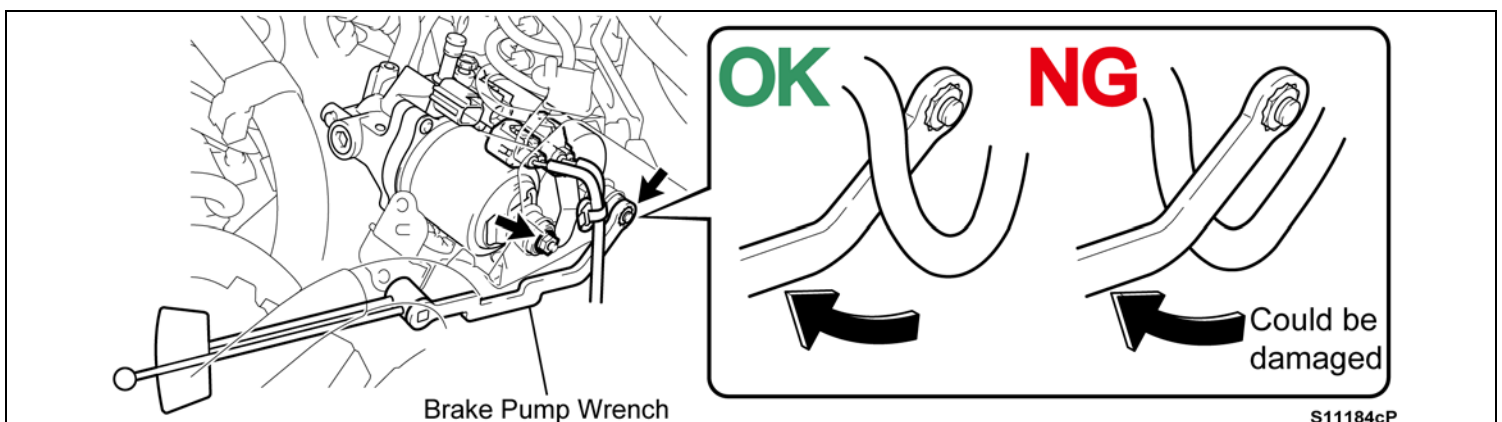

S11184cP

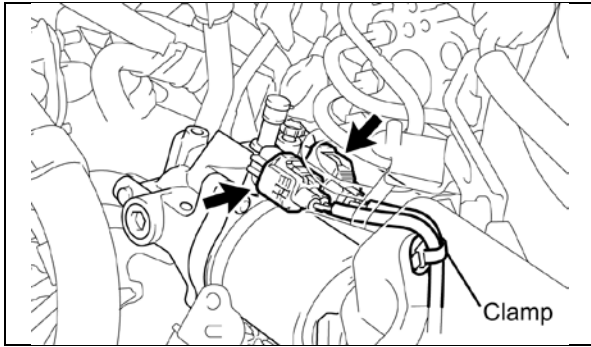

5. CONNECT THE ACCUMULATOR CONNECTORS

- a) Connect the harness clamp and the 2 connectors.

NOTE: Remove the protective tape from the brake tube.

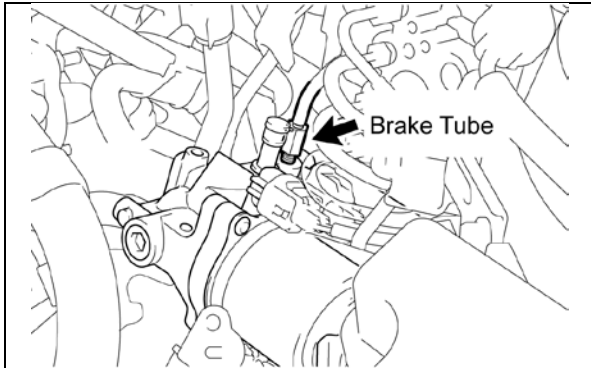

6. REINSTALL THE FRONT No.1 BRAKE TUBE

- a) Remove the plug from the accumulator.
- b) Remove the plastic bag from the brake line.
- c) Insert the brake tube perpendicularly into the pump until it seats.
- d) Hold the brake tube and tighten the flare nut by hand.
- e) Torque the flare nut.

Torque: 11ft. lbf (15N·m)

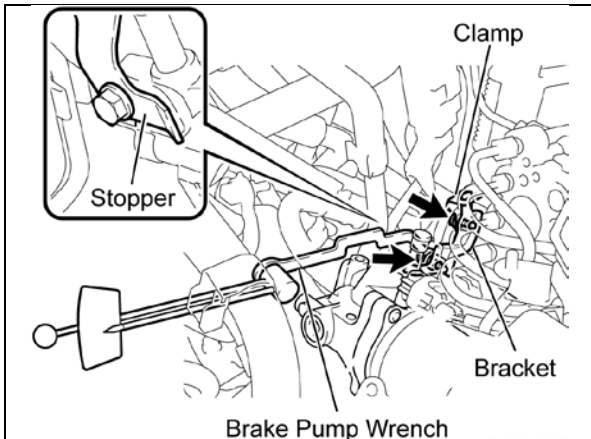
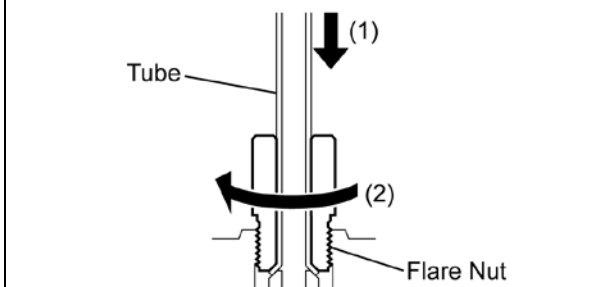

7. SECURE THE BRACKET AND CLAMP

- a) Install the bracket with 1 bolt then install the clamp with 1 bolt.
- b) Use the brake pump wrench (campaign tool) to tighten the bolts.

Torque: 40in. lbf (4.5N·m)

NOTE: Confirm the stopper on the bracket is touching the accumulator.



8. REINSTALL THE FUEL LINES

- a) Return the clamps to their original horizontal positions and engage the tubes in the clamps.

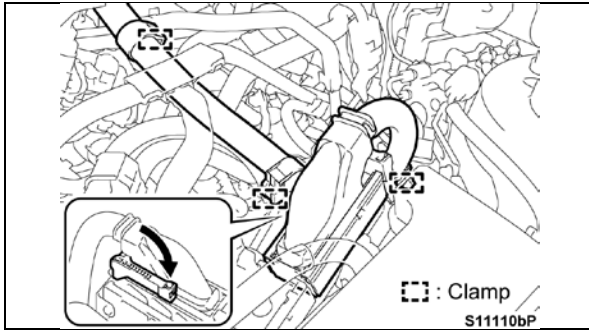

9. RECONNECT THE ENGINE HARNESS

- a) Remove the protective tape and bag from the harness and ECU.
- b) Connect and lock the connector.
- c) Engage the 3 harness clamps.

NOTE: Confirm the connector is fully secured and locked in place.

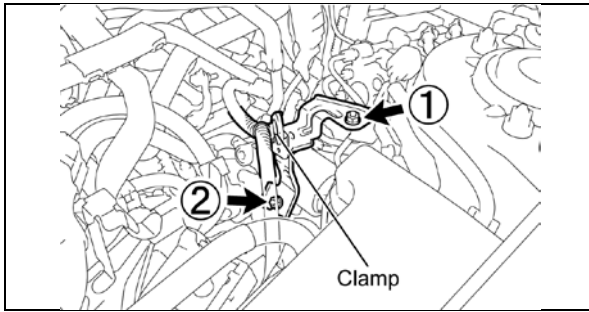

10. REINSTALL THE No.5 BRAKE ACTUATOR BRACKET

- a) Install the nuts and torque in the order shown in the illustration.
- b) Engage the harness clamp.

Torque: 75in. lbf (8.5N·m)

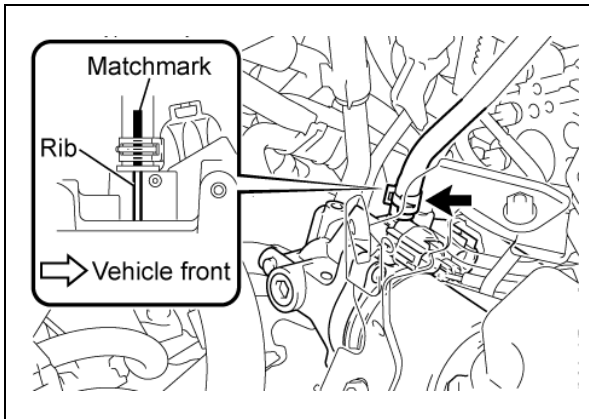

11. RECONNECT THE BRAKE ACTUATOR HOSE

- a) Remove the cap from the accumulator.
- b) Remove the hose plug from the hose.
- c) Connect the hose to the accumulator.
- d) Align the matchmark on the hose with the rib on the accumulator.
- e) Secure the hose with the clip.

NOTE:

- Connect the hose immediately after removing the plug in order to prevent brake fluid from leaking.
- Install the clip into its original position.

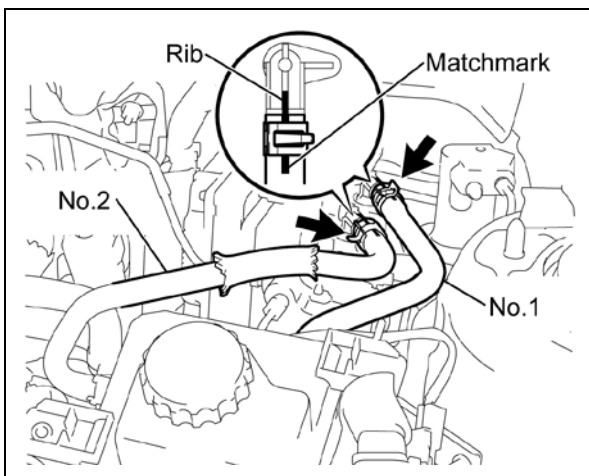

12. RECONNECT THE No.1 RESERVOIR TUBE AND No.2 BRAKE MASTER CYLINDER RESERVOIR TUBES

- a) Remove the hose plugs from the hoses.
- b) Connect the hoses to the accumulator.
- c) Align the matchmark on the hoses with the ribs on the accumulator.
- d) Secure the hoses with the clips.

NOTE:

- Confirm the hoses are connected in the correct positions on the accumulator.
- Connect the hose immediately after removing the plug in order to prevent brake fluid from leaking.
- Install the clip into its original position.

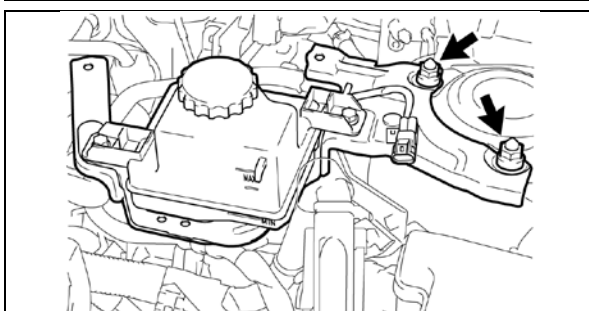

13. REINSTALL THE BRAKE MASTER CYLINDER RESERVOIR WITH BRACKET

- a) Install the reservoir with bracket with the 2 nuts.

Torque: 37ft. lbf (50N·m)

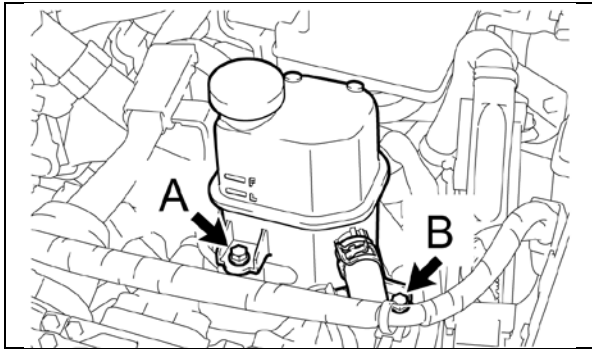

14. REINSTALL THE INVERTER RESERVE TANK ASSEMBLY

- a) Loosely install both bolts.
- b) Torque bolt B then torque bolt A.

Torque: 7ft. lbf (10N·m)

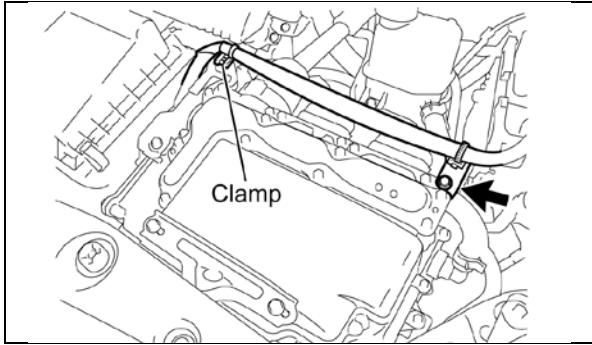

- c) Secure the engine room main wire harness with the bolt.
- d) Engage the harness clamp.

Torque: 9ft. lbf (12N·m)

X. BRAKE SYSTEM BLEEDING PRECAUTIONS



CRITICAL INFORMATION – READ THOROUGHLY



These cautions should be observed when bleeding the brake system. Failure to follow these cautions could result in damaged parts or inadequate repair quality.

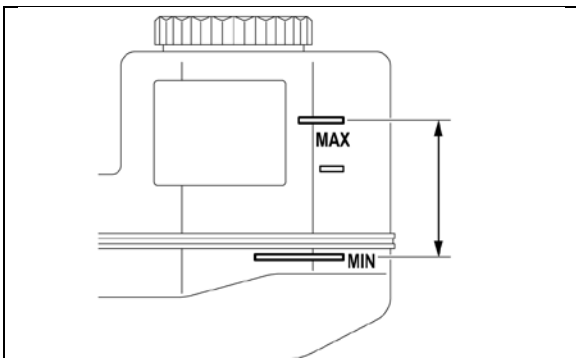

1. FLUID LEVEL

- a) To prevent air entering the brake system, **ALWAYS** maintain the fluid level between the MIN and MAX lines.

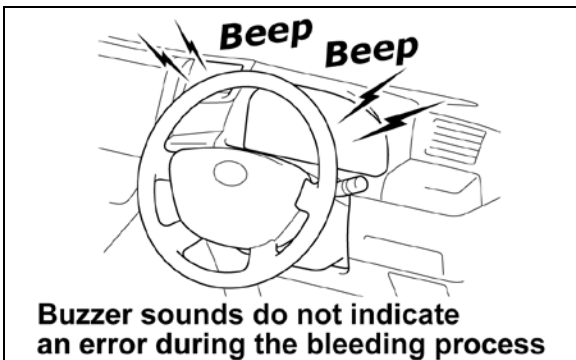

2. WARNING BUZZER

- a) A buzzer may sound during the bleed procedure indicating a pressure decrease, this is normal.

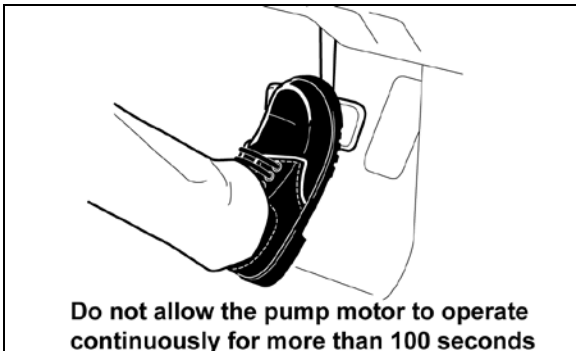

3. PUMP MOTOR

- a) To avoid potential damage to the pump motor, **DO NOT** allow the motor to operate continuously for more than 100 seconds. To stop the motor from operating, release the brake pedal.



4. DTCs

- a) It is normal for DTCs to be set when bleeding the system. DTCs should be cleared when instructed to do so.

XI. BRAKE SYSTEM BLEEDING

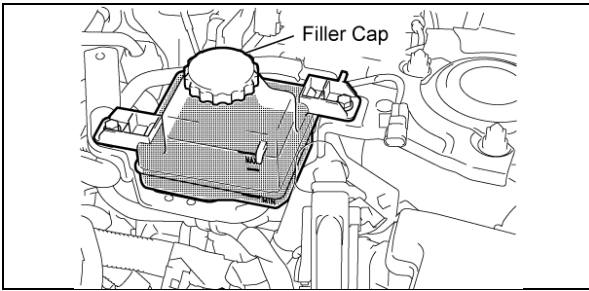

1. RAISE THE VEHICLE AND REMOVE THE WHEELS

2. FILL THE RESERVOIR WITH BRAKE FLUID

a) Fill the reservoir between the MIN and MAX indicators.

3. REINSTALL THE SERVICE GRIP

4. RECONNECT THE BATTERY

NOTE: READY ON may remain inactive after reconnecting the battery. If this happens, open and close the driver door once with IG OFF to reset the system.

5. BLEED THE BRAKE SYSTEM

- Connect a battery charger.
- Connect Techstream.
- Enter the ABS/VSC/TRAC ECU.
- Click on 'Utility' and select 'Air Bleeding'
- Select 'ABS actuator has been replaced'.



- Carefully read and follow the instructions on the Techstream while bleeding the system. If the instructions are not followed or a mistake is made, start the procedure over again.
- If the accumulator is operated when the reservoir is empty, the accumulator could be damaged. Confirm the fluid level is always between the MIN and MAX indicators.
- If the bleed procedure will not complete successfully after several attempts, it may be necessary to replace the brake booster assembly.

- After bleeding is complete, tighten each bleeder plug to the specified torque.
- Disconnect the battery charger.
- Confirm there is no brake fluid leakage.
- Install the wheels.

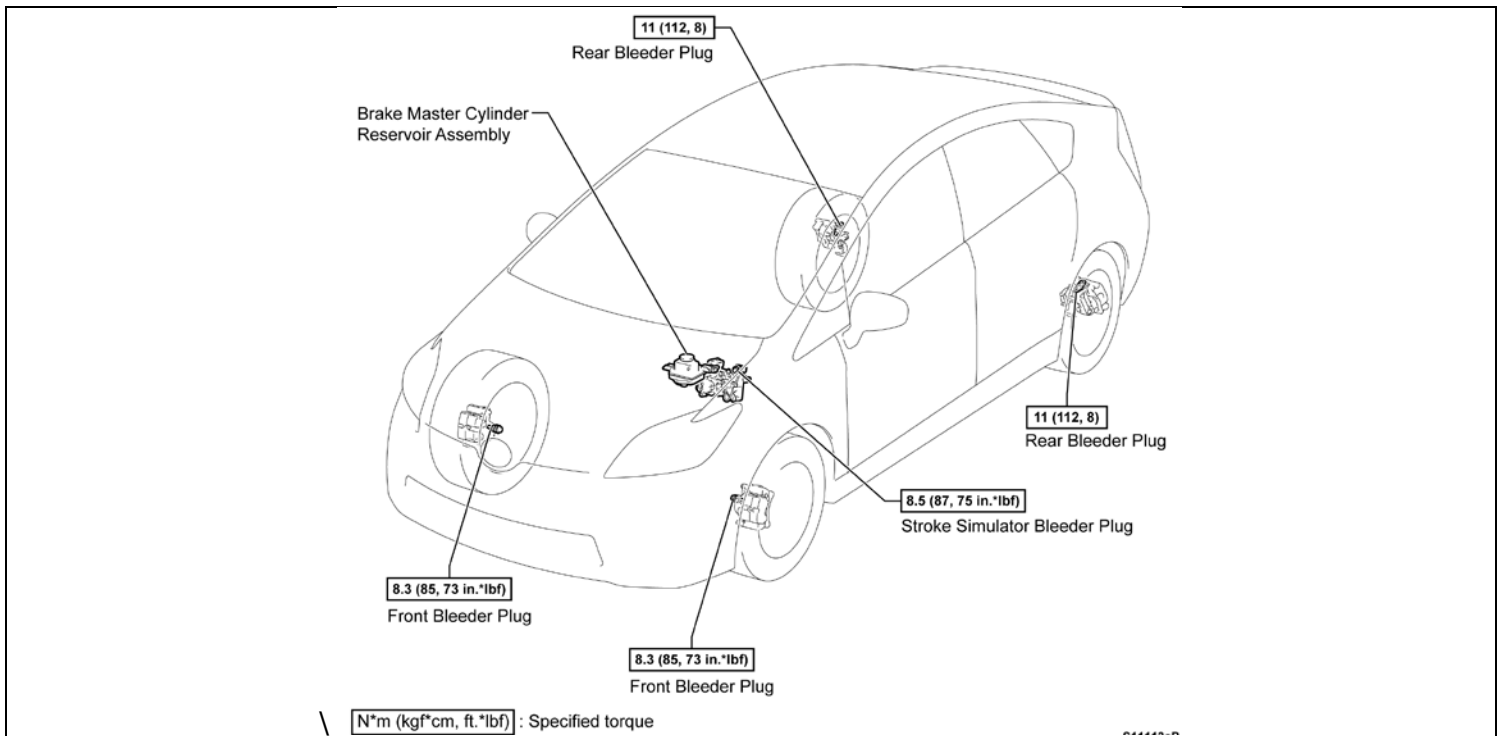

XII. FINAL VEHICLE ASSEMBLY

1. REINSTALL THE FRONT WIPER MOTOR AND OUTER COWL TOP PANEL SUB-ASSEMBLY

- a) Refer to [TIS](#) for installation instructions.

2. INITIALIZE STEERING ANGLE NEUTRAL POINT

- a) Turn the vehicle to READY ON, then turn the steering wheel all the way to the left then all the way to the right.

NOTE:

- This must be performed with the vehicle on level ground.
- Confirm the parking brake is applied.
- If the system does not set correctly 'System Initializing' will display on the navigation screen and the advance parking guidance system will not function correctly.

3. CHECK AND CLEAR DTCs



If DTC C1345 'Linear Solenoid Valve Offset Learning Undone' is found after the bleeding procedure, the bleed procedure was not completed correctly. Conduct the 'Linear Solenoid Valve Offset Learning' by referring to TIS: Brake / Electronically Controlled Brake System: Initialization. If you continue to have difficulties, contact TAS.

4. PERFORM ISC INITIALIZATION



If the ISC initialization is skipped, a rattle sound may be emitted from the transaxle.

MAINTENANCE MODE

- a) Connect Techstream.
- b) Enter the Hybrid Control ECU.
- c) Click on 'Utility' and select 'Inspection Mode'
- d) Select '2WD for Measuring Exhaust Gas'
- e) Confirm 'Maintenance Mode' is displayed on the instrument cluster, then READY ON the vehicle.
- f) Enter the Engine and ECT ECU and go to the data list.
- g) Warm up the engine until the coolant temperature exceeds 158°F (70°C).
- h) Turn IG OFF and then back to READY ON.
- i) Start the engine by depressing the accelerator pedal.
- j) Wait until the engine stops, then confirm the ISC Learning reads 'Compl'.

NOTE: The engine normally automatically stops within 1 minute; however, if the battery charge is low it may take longer.

5. TEST DRIVE THE VEHICLE

01 - 10815

User Help

Data Engine and ECT Live

Parameter	Value	Unit
Coolant Temp	170	F
ISC Learning	compl	

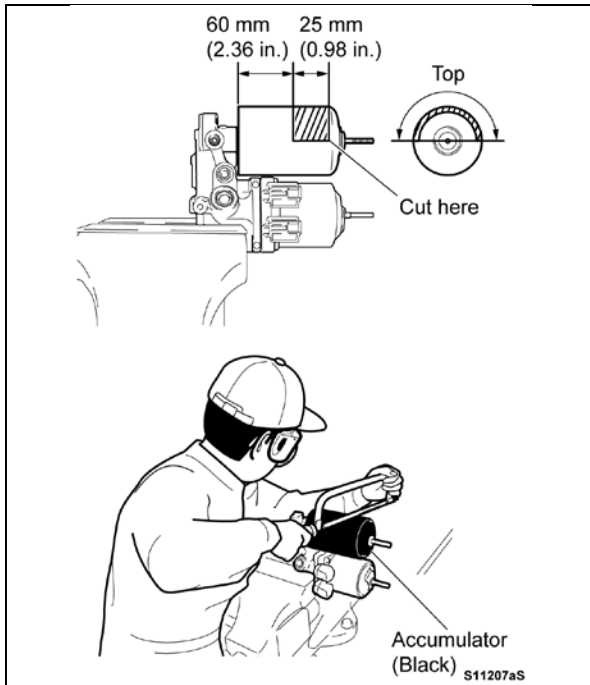

6. DISPOSE OF OLD ACCUMULATOR

- Clamp the accumulator in a vise.
- Use a hacksaw to make a relief cut in the black accumulator cylinder in the area highlighted in the illustration.

NOTE: The enclosed nitrogen gas is colorless, odorless, and non-toxic.



- ALWAYS** wear protective glasses.
- Cut the accumulator slowly.**
- DO NOT** use power tools.

◀ VERIFY REPAIR QUALITY ▶

- Confirm the accumulator label and DTC inspection is followed exactly as described
- Confirm the brake pressure is released before disconnecting any brake lines
- Confirm brake bleeding and ISC initialization are completed correctly

If you have any questions regarding this update, please contact your area representative.

XIII. APPENDIX

A. CAMPAIGN DESIGNATION DECODER

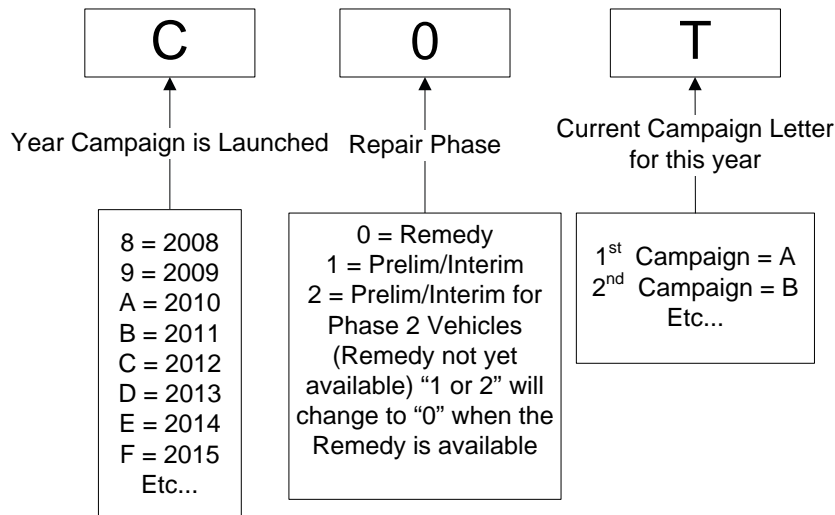

B. CAMPAIGN PARTS DISPOSAL

As required by Federal Regulations, please make sure all campaign parts (original parts) removed from the vehicle are disposed of in a manner in which they will not be reused, **unless requested for parts recovery return.**