

# PRECAUTION

## 1. PRECAUTIONS

- (a) Before inspecting and repairing the fuel system, disconnect the cable from the negative (-) battery terminal.
- (b) Do not smoke or work near fire when handling the fuel system.
- (c) Keep gasoline away from rubber or leather parts.

## 2. DISCHARGE FUEL SYSTEM PRESSURE

### CAUTION:

- Perform the following procedure to prevent fuel from spilling out before removing any fuel system parts.
- Pressure will still remain in the fuel lines even after performing the following procedure. When disconnecting a fuel line, cover it with a piece of cloth to prevent fuel from spraying or coming out.

- (a) Remove the rear seat cushion assembly **INFO**.



- (b) Remove the rear floor service hole cover.

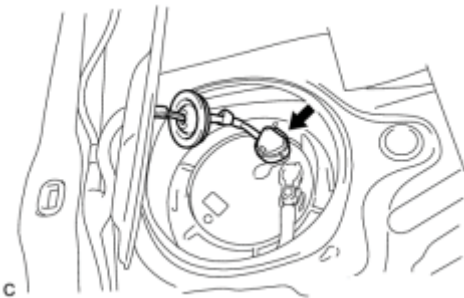

- (c) Disconnect the fuel pump connector.

- (d) Put the vehicle in the "inspection mode" **INFO**.

- (e) Start the engine.

- (f) After the engine has stopped on its own, turn the power switch off.

### HINT:

DTCs P0171/25 may be detected.

(g) Crank the engine again and make sure that the engine does not start.

(h) Disconnect the cable from the negative (-) battery terminal.

**NOTICE:**

When disconnecting the cable, some systems need to be initialized after the cable is reconnected **INFC**.

(i) Connect the fuel pump connector.

(j) Loosen the fuel tank cap, then discharge the pressure in the fuel tank completely.

**3. FUEL LINE**

(a) When disconnecting a high-pressure fuel line, a large amount of gasoline will spray out. Perform the following procedure:

(1) Discharge fuel system pressure.

(2) Disconnect the fuel tube.

(3) Drain the fuel remaining inside the fuel pump tube into a container.

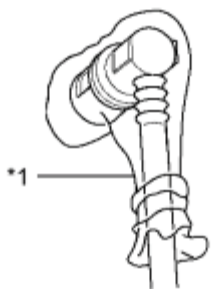

(4) Cover the disconnected pipe and connector with a plastic bag to prevent damage and contamination.

**Text in Illustration**

*1	Plastic Bag
----	-------------

(b) Perform the following procedure when disconnecting a fuel delivery pipe (metallic type):

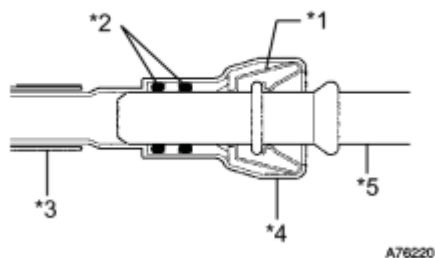

**Text in Illustration**

*1	Retainer
----	----------

*2	O-ring
*3	Nylon Tube
*4	Housing
*5	Pipe

HINT:

The structure of a fuel tube connector is as shown in the illustration.

(1) Check if there is any damage or foreign objects on the pipe connections.

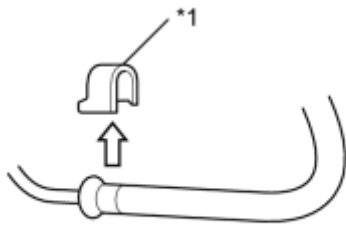

(2) Remove the No. 2 fuel pipe clamp.

### Text in Illustration

*1	No. 2 Fuel Pipe Clamp
----	-----------------------

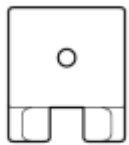

Type A



Type B

NOTICE:

Do not reuse the fuel pipe clamp.

c

(3) Find the metallic connector of the fuel tube assembly.

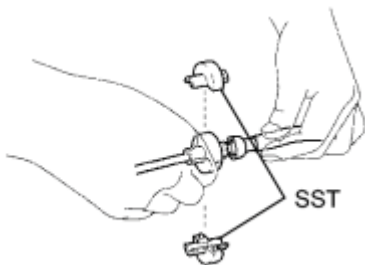

(4) Assemble SST to the connector as shown in the illustration.

SST: 09268-21010

P

(5) Turn SST, align the retainers inside the connector with the SST chamfers and insert SST into the connector.

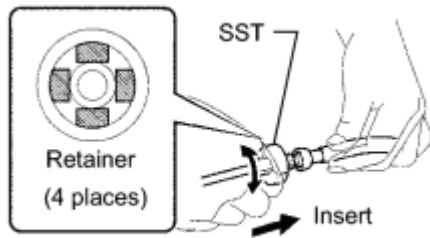

P

(6) Slide SST and the connector together towards the fuel tube assembly.

(c) Perform the following procedure when connecting a fuel tube connector (metallic type):

(1) Check if there is any damage or foreign objects on the pipe connections.

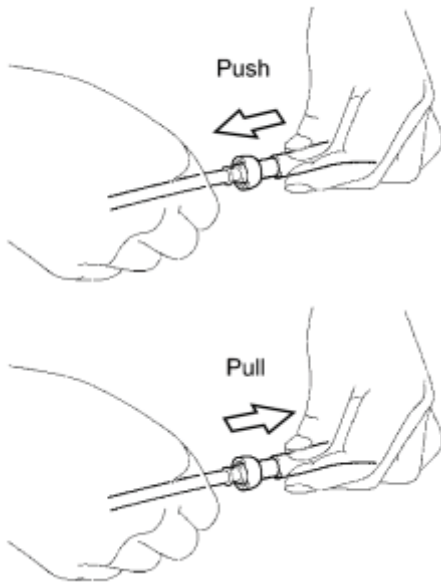

(2) Match the axis of the connector with the axis of the pipe, and push the pipe into the connector until the connector makes a "click" sound. If the pipe is difficult to push into the connector, apply a small amount of clean engine oil to the tip of the pipe.

(3) After connecting, check if the pipe and the connector are securely connected by pulling on them.

(4) Install a new No. 2 fuel pipe clamp.

## Text in Illustration

*1	No. 2 Fuel Pipe Clamp
----	-----------------------

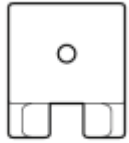
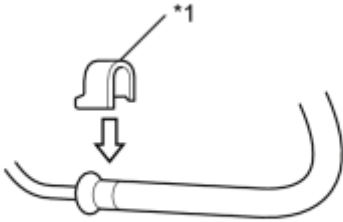

Type A



Type B

c

(5) Check for fuel leaks.

(d) Perform the following procedure when disconnecting a fuel tube connector (quick type A):



c

(1) Release the claw and remove the No. 1 fuel pipe clamp.

(2) Check that there is no dirt or other foreign objects on the pipe and contact surface before disconnecting them. Clean them if necessary.

(3) Disconnect the connector from the pipe by hand.

NOTICE:

Be sure to disconnect the connector by hand.

(4) If the connector and the pipe are stuck, push in and pull on the connector to release them. Pull the connector out of the pipe carefully.

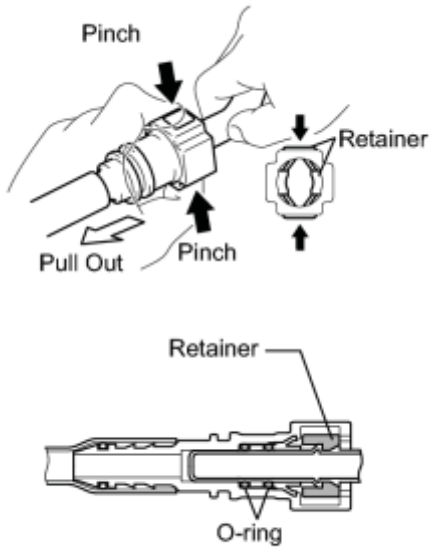

(5) Check that there is no dirt or other foreign objects on the contact surface of the disconnected pipe. Clean them away if necessary.

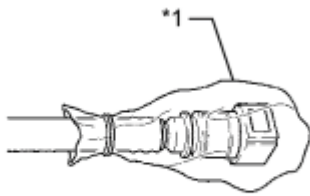

(6) Cover the disconnected pipe and connector with a plastic bag to prevent damage and contamination.

### Text in Illustration

*1	Plastic Bag
----	-------------

P

(e) Perform the following procedure when connecting a fuel tube connector (quick type A):

(1) Check if there is any damage or foreign objects on the pipe connections.

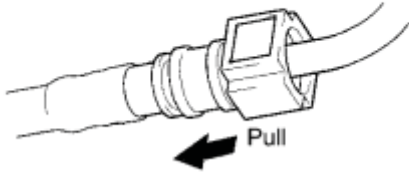
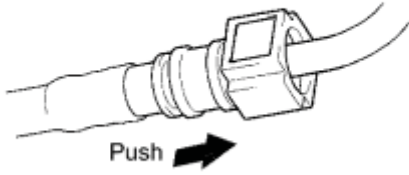

(2) Line up the two parts of the pipes to be connected, and push them together until the connector makes a "click" sound. If the pipe is difficult to push into the connector, apply a small amount of clean engine oil to the tip of the pipe and reinsert it.

(3) After connecting the pipes, check that the pipe and connector are securely connected by pulling on them.

(4) Inspect for fuel leaks INFO.



(5) Engage the lock claw and install the No. 1 fuel pipe clamp.

(f) Perform the following procedure when disconnecting a fuel tube connector (quick type B):

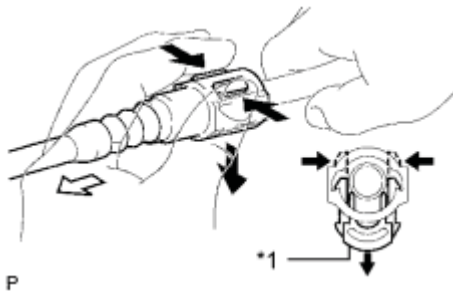

## Text in Illustration

\*1

Retainer

- (1) Check that there is no damage or foreign matter on the part of the pipe that contacts the connector.
- (2) Detach the 2 claws of the connector retainer. Push down on the connector and disconnect it from the pipe.

HINT:

Be sure to disconnect it by hand.

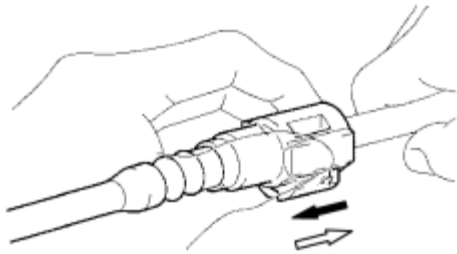

P

- (3) If the connector and pipe are stuck, pinch the fuel pipe by hand and push or pull the connector to disconnect it.

- (4) Check for foreign matter on the seal surface of the disconnected pipe. Clean it if necessary.

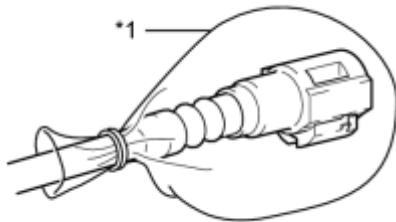

P

- (5) Cover the disconnected pipe and connector with a plastic bag to prevent damage and contamination.

## Text in Illustration

\*1

Plastic Bag

- (g) Perform the following procedure when connecting a fuel tube connector (quick type B):

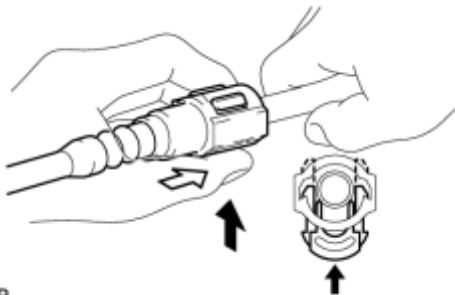

P

- (1) Line up the two parts of the pipes to be connected, and fully push the fuel tube connector and pipe together until they are fully seated. Next, push the retainer into the connector until its claws lock. If the pipe is difficult to push into the connector, apply a small amount of clean engine oil to the tip of the pipe and reinsert it.

- (2) After connecting the pipes, check that the pipe and connector are securely connected by pulling on them.

- (3) Inspect for fuel leaks INFO.



(h) Observe the following precautions when handling a nylon tube:

**CAUTION:**

- Do not twist the connector part of the nylon tube or the quick connector when connecting them.
- Do not bend or twist the nylon tube.
- Do not remove the EPDM protector on the outside of the nylon tube.
- Do not pinch or kink the nylon tubes to prevent fuel leakage.

**4. INJECTOR**

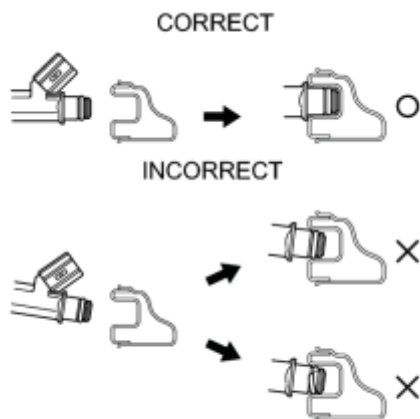

(a) Observe the following precautions when removing and installing a fuel injector:

- (1) Do not reuse an O-ring and insulator.
- (2) When placing a new O-ring onto the injector, do not damage the O-ring.
- (3) Coat the new O-ring with grease or gasoline before installing it. Do not use engine oil, gear oil or brake fluid.

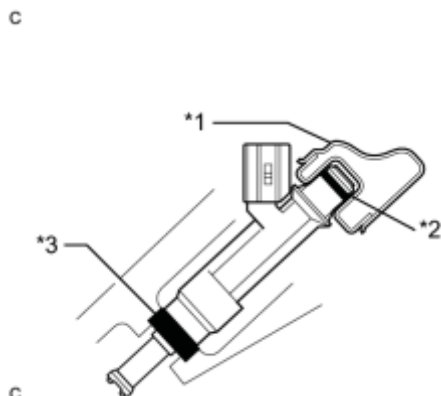

(b) Install the injector into the delivery pipe and cylinder head as shown in the illustration. Apply grease or gasoline to the contact surfaces of the injector before installing the injector.

**Text in Illustration**

*1	Delivery Pipe
*2	O-ring
3	Insulator

**5. FUEL SUCTION TUBE ASSEMBLY WITH PUMP AND GAUGE**

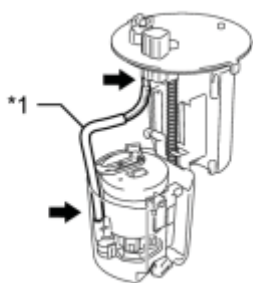

(a) Do not disconnect the tube shown in the illustration when disassembling the fuel suction tube assembly with pump and gauge. Doing so will cause reassembly of the fuel suction tube assembly with pump and gauge to be impossible as the tube is welded to the plate.

**Text in Illustration**

*1	Tube
----	------

**6. INSPECT FOR FUEL LEAK**

(a) Check that there is no fuel leakage after performing maintenance anywhere on the fuel system .