

INITIALIZATION

1. DESCRIPTION

(a) Perform initialization and calibration of the linear solenoid valve when the brake booster with master cylinder (skid control ECU, brake actuator or pressure sensor), brake pedal stroke sensor or brake pedal is replaced.

Follow the procedure to perform initialization.

HINT:

- If there is a problem with the auxiliary battery (12 V) voltage, initialization and calibration of the linear solenoid valve cannot be completed normally. Make sure to check the auxiliary battery voltage before performing initialization and calibration of the linear solenoid valve.
- If the actuator's temperature is high, initialization and calibration of the linear solenoid valve may not be completed normally. If so, wait until the temperature decreases and then perform initialization and calibration of the linear solenoid valve.
- If the power switch is turned off, the brake pedal is operated, parking brake is applied or vehicle speed signal is input while the linear solenoid valve offset learning is being performed, the learning will be cancelled.

Part to be Replaced	Necessary Operation
Brake booster with master cylinder (Skid control ECU, brake actuator or pressure sensor)	Initialization and calibration of the linear solenoid valve
<ul style="list-style-type: none">• Brake pedal stroke sensor• Brake pedal	<ol style="list-style-type: none">1. Clearing stored linear solenoid valve calibration data2. Initialization and calibration of the linear solenoid valve

2. PERFORM INITIALIZATION AND CALIBRATION OF LINEAR SOLENOID VALVE (When Using the Techstream)

NOTICE:

If the brake control has been disabled, or the brake pedal stroke sensor or brake pedal has been replaced, it is necessary to perform linear solenoid valve learning.

If the brake booster with master cylinder has been replaced, or the brake booster pump or brake master cylinder reservoir has been replaced, linear solenoid valve learning will be automatically performed during the Bleed Brake System procedure .

(a) Clear the stored linear solenoid valve calibration data.

(1) Turn the power switch off.

(2) Check that the steering wheel is centered.

(3) Check that park (P) is selected.

- (4) Connect the Techstream to the DLC3.
- (5) Turn the power switch on (IG).
- (6) Turn the Techstream on.
- (7) Select the skid control ECU to clear the linear solenoid valve calibration data using the Techstream. Enter the following menus: Chassis / ABS/VSC/TRAC / Utility / Reset Memory.
- (8) Perform initialization and calibration of the linear solenoid valve.
- (9) Perform the zero point calibration of yaw rate and acceleration sensor .
- (b) Perform initialization and calibration of the linear solenoid valve.
- (1) Turn the power switch off.
- (2) Check that the steering wheel is centered.
- (3) Check that park (P) is selected.
- (4) Check that the parking brake is released.

NOTICE:

Linear valve offset learning cannot be started with the parking brake applied. If the parking brake is applied during offset learning, the learning process will be canceled and then restarted when the parking brake is released.

- (5) Connect the Techstream to the DLC3.
- (6) Turn the power switch on (IG) with the brake pedal released.

NOTICE:

- If the linear solenoid valve offset learning is performed without turning the power switch on (IG), the learning process may not be completed properly because of insufficient auxiliary battery voltage.
- When the linear solenoid valve offset learning is interrupted, or the learning process is performed with park (P) is not selected, DTC C1345 (Linear Solenoid Valve Offset Learning Undone) will be stored.

- (7) Turn the Techstream on.
- (8) Switch the skid control ECU to the Test Mode using the Techstream. Enter the following menus: Chassis / ABS/VSC/TRAC / Utility / ECB* Utility / Linear Valve Offset.

*: Electronically Controlled Brake System

- (9) Leave the vehicle stationary without depressing the brake pedal for 1 or 2 minutes.
- (10) Check that the interval between blinks of the brake warning light /

Test Mode Blinking Pattern:

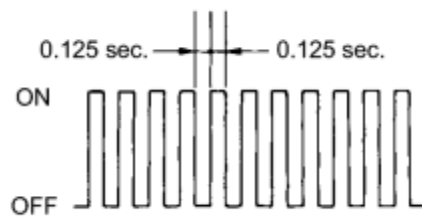

yellow (minor malfunction) changes from 1 second to 0.25 seconds.

- The time needed to complete initialization and calibration of the linear solenoid valve varies depending on auxiliary battery voltage.
- The brake warning light / yellow (minor malfunction) blinks at 1 second intervals during initialization and calibration of the linear solenoid valve and changes to the Test Mode display.
- The brake warning light / yellow (minor malfunction) blinks at 0.25 seconds intervals if the Test Mode is normal.

(11) Check that DTC C1345 (Linear Solenoid Valve Offset Learning Undone) which indicates trouble with stroke sensor zero point learning is not output when the brake warning light / yellow (minor malfunction) changes to the Test Mode display upon initialization and calibration of the linear solenoid valve completion.

(12) Enter the normal mode from the Test Mode following the Techstream directions.

HINT:

Refer to the Techstream operator's manual for further details.

3. PERFORM INITIALIZATION AND CALIBRATION OF LINEAR SOLENOID VALVE (When not Using the Techstream)

NOTICE:

If the brake control has been disabled, or the brake pedal stroke sensor or brake pedal has been replaced, it is necessary to perform linear solenoid valve learning.

If the brake booster with master cylinder has been replaced, or the brake booster pump or brake master cylinder reservoir has been replaced, linear solenoid valve learning will be automatically performed during the Bleed Brake System procedure INFO.

(a) Clear the stored linear solenoid valve calibration data.

(1) Turn the power switch off.

(2) Check that the steering wheel is centered.

(3) Check that park (P) is selected.

(4) Check that the parking brake is released.

NOTICE:

Linear valve offset learning cannot be started with the parking brake applied. If the parking brake is applied during offset learning, the learning process will be canceled and then restarted when the parking brake is released.

(5) Turn the power switch on (IG) with the brake pedal released.

(6) Using SST, connect and disconnect terminals TS and CG of the DLC3 4 times or more within 8 seconds.

SST: 09843-18040

Text in Illustration

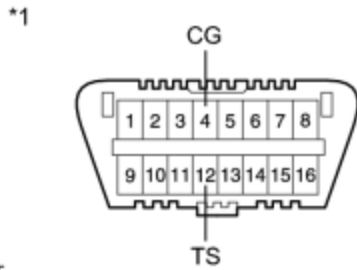

*1 Front view of DLC3

(7) Check that no codes other than ABS code 42, VSC code 45 and electronically controlled brake system code 48, 66, or 95 are stored in the diagnostic system.

Trouble Code Blinking Pattern (Example Code 42):

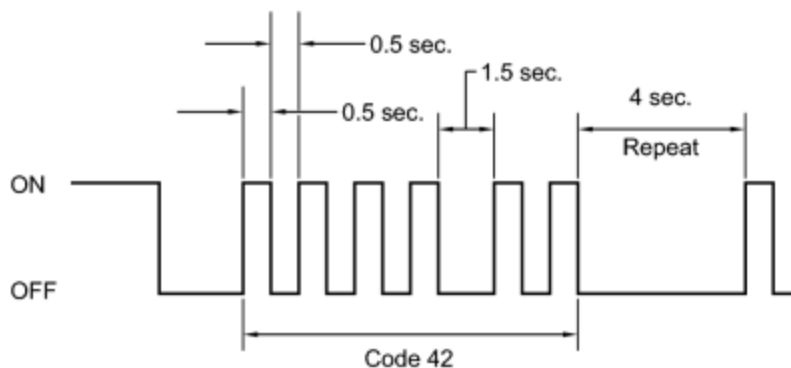

HINT:

The ABS warning, brake warning / yellow (minor malfunction) and slip indicator lights do not indicate a normal system code.

(8) Remove SST from the terminals of the DLC3.

(9) Perform initialization and calibration of the linear solenoid valve.

(10) Perform the zero point calibration of yaw rate and acceleration sensor INFO.

(b) Perform initialization and calibration of the linear solenoid valve.

(1) Turn the power switch off.

(2) Check that the steering wheel is centered.

(3) Check that park (P) is selected.

(4) Using SST, connect terminals TS and CG of the DLC3.

SST: 09843-18040

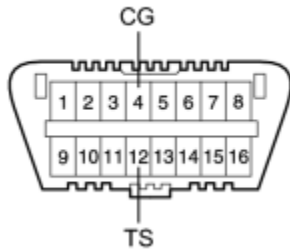

Text in Illustration

*1 Front view of DLC3

(5) Turn the power switch on (IG) with the brake pedal released.

NOTICE:

- If the linear solenoid valve offset learning is performed without turning the power switch on (IG), the learning process may not be completed properly because of insufficient auxiliary battery voltage.
- When the linear solenoid valve offset learning is interrupted, or the learning process is performed with park (P) is not selected, DTC 66 (Linear Solenoid Valve Offset Learning Undone) will be stored.

(6) Leave the vehicle stationary without depressing the brake pedal for 1 or 2 minutes.

(7) Check that the interval between blinks of the brake warning light / yellow (minor malfunction) changes from 1 second to 0.25 seconds.

Test Mode Blinking Pattern:

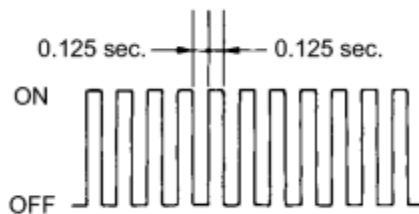

- The time needed to complete initialization and calibration of the linear solenoid valve varies depending on the auxiliary battery voltage.
- The brake warning light / yellow (minor malfunction) blinks at 1 second intervals during initialization and calibration of the linear solenoid valve and changes to the Test Mode display.
- The brake warning light / yellow (minor malfunction) blinks at 0.25 seconds intervals if Test Mode is normal.

(8) Check that DTC 66 (Linear Solenoid Valve Offset Learning Undone) which indicates trouble with stroke sensor zero point learning is not output when the brake warning light / yellow (minor malfunction) changes to the Test Mode display upon initialization and calibration of the linear solenoid valve completion.

(9) Turn the power switch off and disconnect SST from the DLC3.

CALIBRATION

1. DESCRIPTION

(a) After replacing any VSC related components or performing front wheel alignment adjustment, clear and read the sensor calibration data.

Follow the chart below to perform calibration.

Part to be Replaced / Operation	Necessary Operation
Brake booster with master cylinder (Skid control ECU)	Yaw rate and acceleration sensor zero point calibration
Yaw rate and acceleration sensor	<ol style="list-style-type: none">1. Clearing zero point calibration data2. Yaw rate and acceleration sensor zero point calibration
Front wheel alignment adjustment	<ol style="list-style-type: none">1. Clearing zero point calibration data2. Yaw rate and acceleration sensor zero point calibration

2. OBTAIN ZERO POINT OF YAW RATE AND ACCELERATION SENSOR (When Using the Techstream)

NOTICE:

- While obtaining the zero point, keep the vehicle stationary and do not vibrate, tilt, move, or shake it.
- Be sure to perform this procedure on a level surface (with an inclination of less than 1 degree).

(a) Clear the zero point calibration data.

(1) Turn the power switch off.

(2) Check that the steering wheel is centered.

(3) Check that park (P) is selected.

(4) Connect the Techstream to the DLC3.

(5) Turn the power switch on (IG).

(6) Turn the Techstream on.

(7) Select the skid control ECU to clear the zero point calibration data using the Techstream. Enter the following menus: Chassis / ABS/VSC/TRAC / Utility / Reset Memory.

(8) Turn the power switch off.

NOTICE:

If the power switch is turned on (IG) for more than 15 seconds with park (P) is selected after the zero point of the yaw rate and acceleration sensor has been cleared, only the zero point of the yaw rate sensor will be stored. If the vehicle is driven under these conditions, the skid control ECU will store the zero point calibration for the acceleration sensor as not being completed. The skid control ECU will then also indicate this as a malfunction of the VSC system using the indicator light.

(b) Perform the zero point calibration of the yaw rate and acceleration sensor.

(1) Turn the power switch off.

(2) Check that the steering wheel is centered.

(3) Check that park (P) is selected.

NOTICE:

DTCs C1210 (Zero Point Calibration of Yaw Rate Sensor Undone) and C1336 (Zero Point Calibration of Acceleration Sensor Undone) will be stored if park (P) is not selected.

(4) Connect the Techstream to the DLC3.

(5) Turn the power switch on (IG).

(6) Turn the Techstream on.

(7) Switch the skid control ECU to Test Mode using the Techstream. Enter the following menus: Chassis / ABS/VSC/TRAC / Utility / Test Mode.

(8) After Test Mode has been entered, keep the vehicle stationary on a level surface for 2 seconds or more.

Test Mode Blinking Pattern:

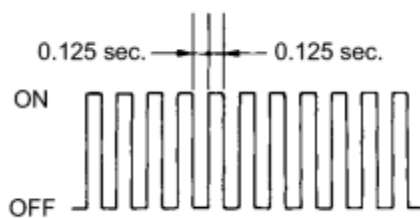

(9) Check that the ABS warning, brake warning / yellow (minor malfunction) and slip indicator lights come on for several seconds and then blink in Test Mode.

- If the ABS warning, brake warning / yellow (minor malfunction) and slip indicator lights do not blink, perform zero point calibration again.
- The zero point calibration is performed only once after the system enters Test Mode.
- Calibration cannot be performed again until the stored data is cleared.

(10) Turn the power switch off and disconnect the Techstream.

3. OBTAIN ZERO POINT OF YAW RATE AND ACCELERATION SENSOR (When not Using the Techstream)

NOTICE:

- While obtaining the zero point, keep the vehicle stationary and do not vibrate, tilt, move, or shake it.
- Be sure to perform this procedure on a level surface (with an inclination of less than 1 degree).

- (a) Clear the zero point calibration data.
- (1) Turn the power switch off.
- (2) Check that the steering wheel is centered.
- (3) Check that park (P) is selected.
- (4) Turn the power switch on (IG).

(5) Using SST, connect and disconnect terminals TS and CG of the DLC3 4 times or more within 8 seconds.

SST: 09843-18040

Text in Illustration

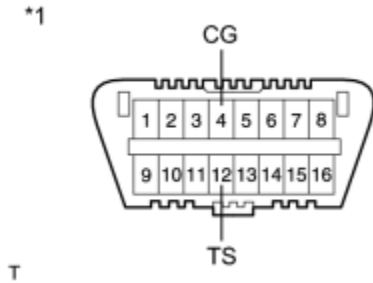

*1	Front view of DLC3
----	--------------------

(6) Check that no codes other than ABS code 42, VSC code 45 and electronically controlled brake system code 48, 66, or 95 are stored in the diagnostic system.

Trouble Code Blinking Pattern (Example Code 42):

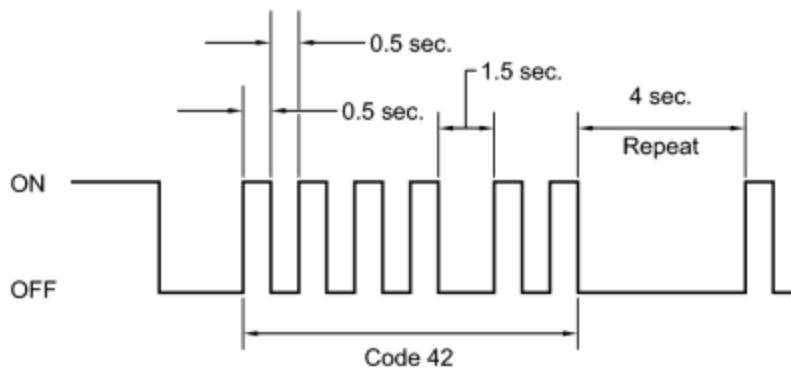

HINT:

The ABS warning, brake warning / yellow (minor malfunction) and slip indicator lights do not indicate a normal system code.

NOTICE:

If the power switch is turned on (IG) for more than 15 seconds with park (P) is selected after the zero point of the yaw rate and acceleration sensor has been cleared, only the zero point of the yaw rate sensor will be stored. If the vehicle is driven under these conditions, the skid control ECU will store the zero point calibration for the acceleration sensor as not being completed. The skid control ECU will then also indicate this as a malfunction of the VSC system using the indicator light.

(7) Turn the power switch off.

(b) Perform the zero point calibration of the yaw rate and acceleration sensor.

(1) Turn the power switch off.

(2) Check that the steering wheel is centered.

(3) Check that park (P) is selected.

NOTICE:

DTCs 36 (Zero Point Calibration of Yaw Rate Sensor Undone) and 98 (Zero Point Calibration of Acceleration Sensor Undone) will be recorded if park (P) is not selected.

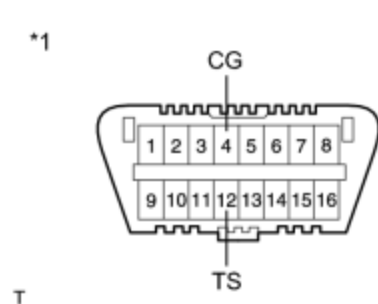

(4) Using SST, connect terminals TS and CG of the DLC3.

SST: 09843-18040

Text in Illustration

*1	Front view of DLC3
----	--------------------

(5) Turn the power switch on (IG).

(6) After Test Mode has been entered, keep the vehicle stationary on a level surface for 2 seconds or more.

Test Mode Blinking Pattern:

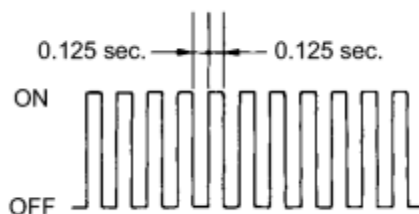

(7) Check that the ABS warning, brake warning / yellow (minor malfunction) and slip indicator lights come on for several seconds and then blinks in Test Mode.

- If the ABS warning, brake warning / yellow (minor malfunction) and slip indicator lights do not blink, perform zero point calibration again.
- The zero point calibration is performed only once after the system enters Test Mode.
- Calibration cannot be performed again until the stored data is cleared.

(8) Turn the power switch off and disconnect SST from the DLC3.