

# QUICK REFERENCE GUIDE



**TOYOTA**

**PRIUS**

**PRIUS AWD**

**2023**

# 2023

## PRIUS

This Quick Reference Guide is a summary of basic vehicle operations. It contains brief descriptions of fundamental operations so you can locate and use the vehicle's main equipment quickly and easily.

The Quick Reference Guide is not intended as a substitute for the Owner's Manual located in your vehicle's glove box. We strongly encourage you to review the Owner's Manual and supplementary manuals so you will have a better understanding of your vehicle's capabilities and limitations.

Your dealership and the entire staff of Toyota Motor North America, Inc. wish you many years of satisfied driving in your new Prius.

### *A word about safe vehicle operations*

This Quick Reference Guide is not a full description of Prius operations. Every Prius owner should review the Owner's Manual that accompanies this vehicle.

Pay special attention to the boxed information highlighted in color throughout the Owner's Manual. Each box contains operating instructions to help you avoid injury or equipment malfunction.

All information in this Quick Reference Guide is current at the time of printing. Toyota reserves the right to make changes at any time without notice.

# INDEX

## OVERVIEW

Engine maintenance	11
Fuel tank door release & cap	9
Hood release	10
Indicator symbols	6-7
Instrument cluster	5
Instrument panel	2-4
Instrument panel light control	10
Keyless entry <sup>1,2</sup>	8
Smart Key system <sup>1,2</sup>	9

## FEATURES & OPERATIONS

Advanced Park <sup>2</sup>	36-37
Air conditioning/heating <sup>1,2</sup>	25
Audio Multimedia	22
Auto lock/unlock <sup>1,2</sup>	14
Blind Spot Monitor (BSM) <sup>2</sup> and Rear Cross Traffic Alert (RCTA) <sup>2</sup>	30
Clock	21
Direct Light Illumination	28
Door lock switches	14
Driving mode select switch <sup>2</sup>	13
EV drive mode	12
Electric parking brake	19
Front and Rear Parking Assist with Automatic Braking (PA w/AB) <sup>1,2</sup>	34-35
Front seats-Adjustments	16
Garage door opener (HomeLink®) <sup>3</sup>	27
Heated/ventilated seats	26
Heated steering wheel	26
Hybrid Synergy Drive System	12
Hybrid transmission	13
Intuitive Parking Assist <sup>1,2</sup>	33
Lights <sup>1,2</sup> & turn signals <sup>1</sup>	18
Multi-Information Display (MID) <sup>1</sup>	20
Panoramic View Monitor (PVM)	32
Power outlet-12V DC	24
Power windows <sup>1</sup>	15
RCD (Rear Camera Detection) <sup>2</sup>	29
Qi Wireless charger	24
Rear seats-Folding	16
Rear view monitor system	29
Safe Exit Assist (SEA) <sup>2</sup>	31

## FEATURES & OPERATIONS (continued)

Seats-Head restraints	16
Steering wheel switches & Telephone controls (Bluetooth®)	21
Tilt & telescopic steering wheel	15
USB Type-C charge ports	23
USB Type-C media port	23
Vehicle Stability Control (VSC)/ TRAC OFF switch	28
Windshield wipers & washers <sup>1</sup>	17

## TOYOTA SAFETY SENSE™ 3.0 (TSS 3.0)

Automatic High Beams (AHB)	52-53
Cruise Control	50-51
Full-Speed Range Dynamic Radar Cruise Control (DRCC)	47-50
Lane Departure Alert (LTA) with Steering Assist	44-46
Lane Tracing Assist (LTA)	43
Over-The-Air (OTA) Updates	39
Proactive Driving Assist (PDA)	55-57
Pre-Collision System with Pedestrian Detection (PCS w/PD)	40-42
Quick overview-Toyota Safety Sense™ 3.0 (TSS 3.0)	38-39
Road Sign Assist (RSA)	53-54
Sensors	39

## SAFETY & EMERGENCY FEATURES

Floor mat installation	64
Rear door child safety locks	58
Safety Connect®	59
Seat belts	58
Seat belts-Shoulder belt anchor	58
Spare tire & tools	60
Star Safety System™	63-64
Tire Pressure Monitoring (warning) System (TPMS)	62
Tire repair kit & tools	61

## GETTING STARTED WITH TOYOTA AUDIO MULTIMEDIA AND CONNECTED SERVICES 66-77

<sup>1</sup> Visit your Toyota dealer for information on customizing this feature.

<sup>2</sup> Programmable by customer. Refer to the "Owner's Manual" for instructions and more information.

<sup>3</sup> HomeLink® is a registered trademark of Gentex Corporation.

# Instrument panel

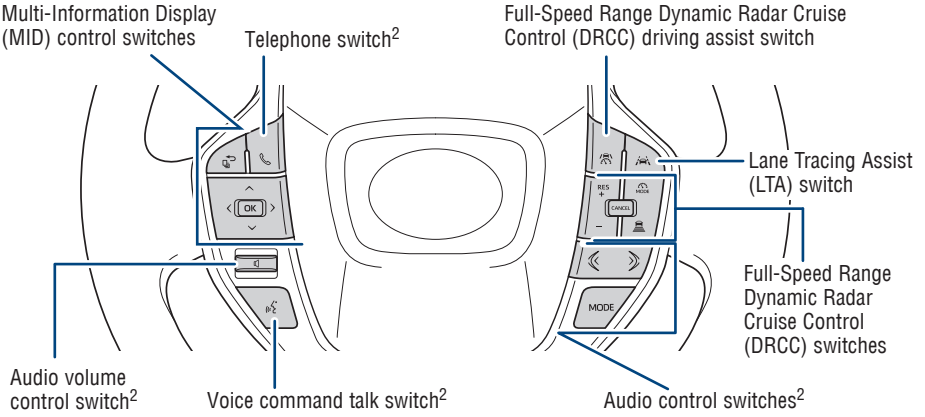

## Steering wheel controls

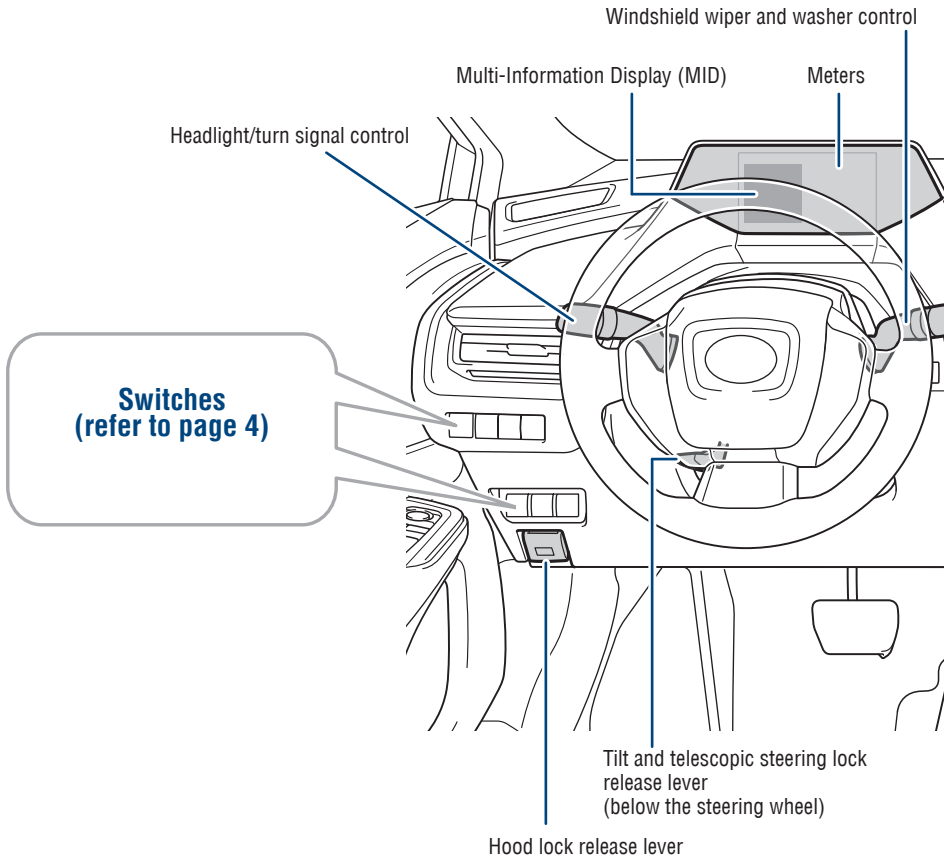

<sup>1</sup> If equipped

<sup>2</sup> For details, refer to the “Multimedia Owner’s Manual” or visit [www.toyota.com/audio-multimedia](http://www.toyota.com/audio-multimedia) for additional resources.

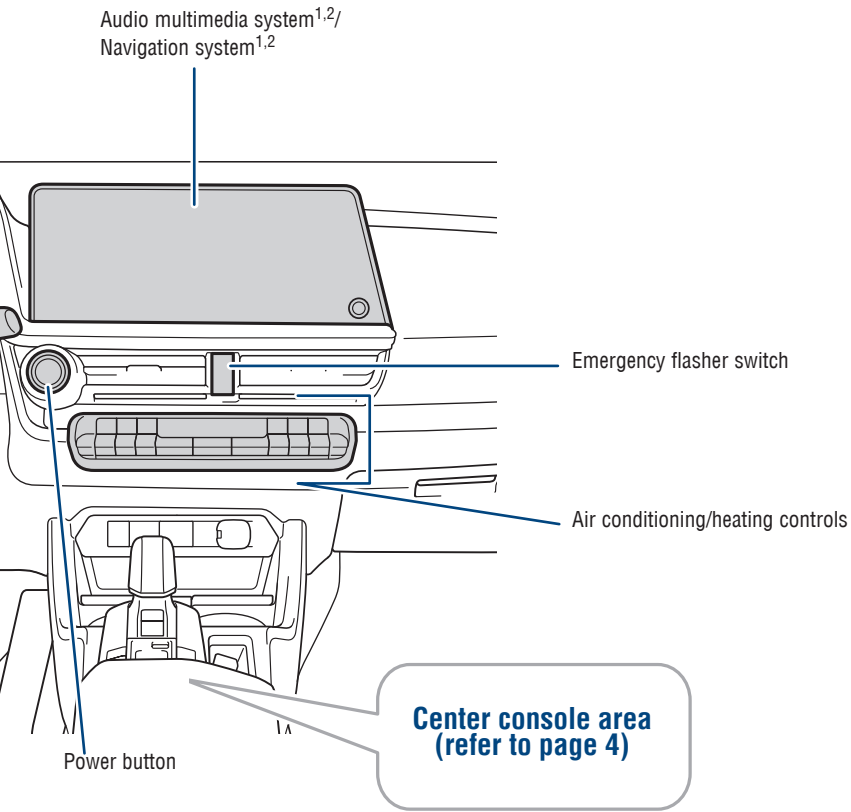

# OVERVIEW

## Instrument panel (continued)

### SWITCHES

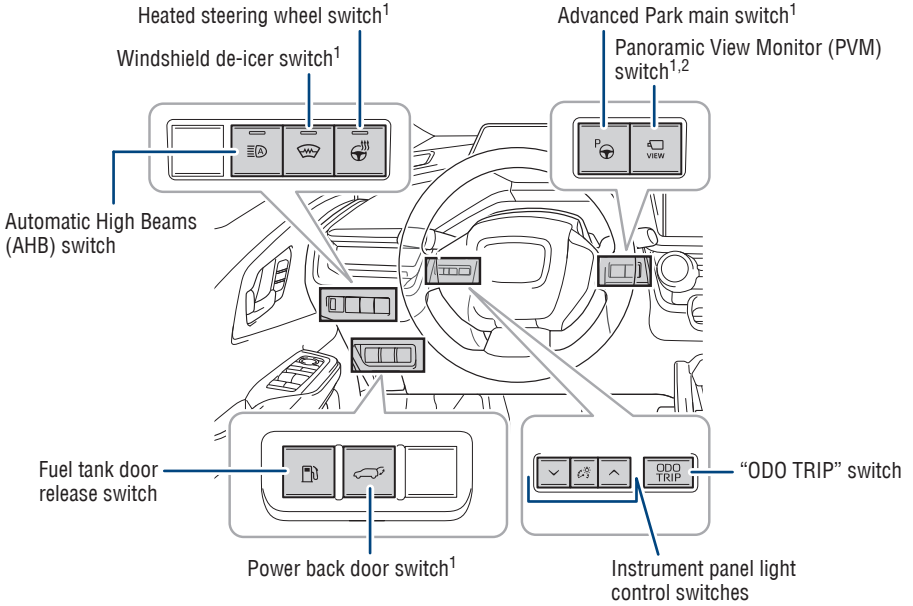

### CENTER CONSOLE AREA

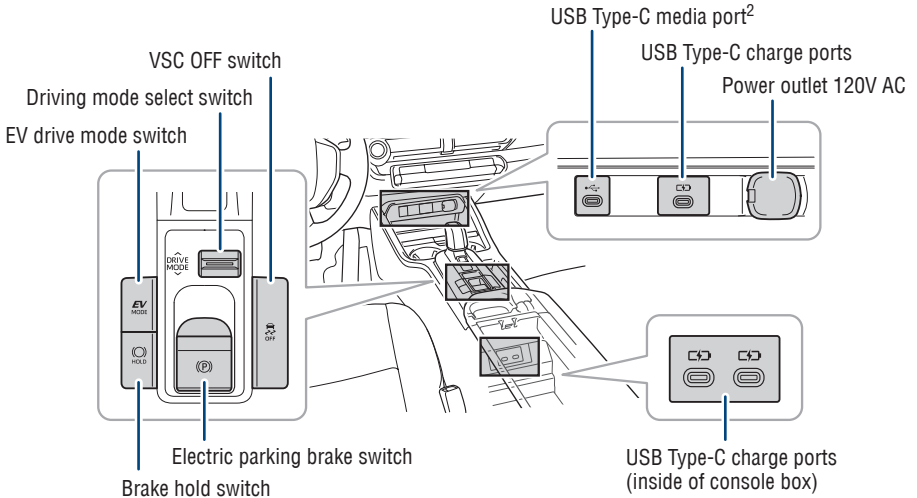

<sup>1</sup> If equipped

<sup>2</sup> For details, refer to the "Multimedia Owner's Manual" or visit [www.toyota.com/audio-multimedia](http://www.toyota.com/audio-multimedia) for additional resources.

# Instrument cluster

## MAIN METER IN CENTER POSITION

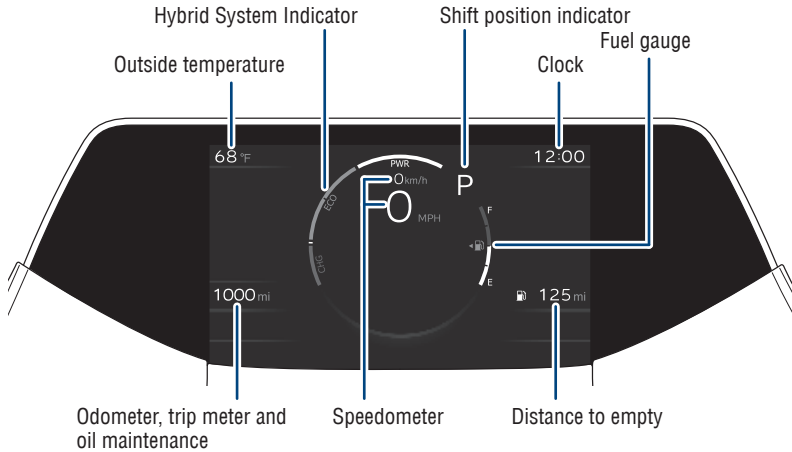

## MAIN METER IN CENTER POSITION

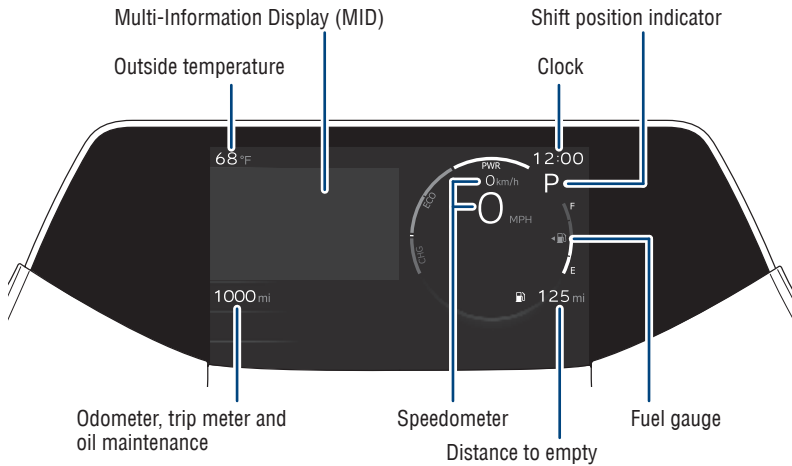























Refer to the "Owner's Manual" for more details.

# OVERVIEW

## Indicator symbols

For details, refer to “Warning lights and indicators,” Section 2, 2023 “Owner’s Manual”.

 <b>ABS</b>	ABS (Anti-lock Brake System) warning <sup>1,5</sup>	 <b>ECO</b>	Eco drive mode indicator
 <b>AHB</b>	AHB (Automatic High Beams) indicator		Electric power steering system warning <sup>1,5</sup> [red/yellow]
 <b>HOLD</b>	Brake hold operating indicator <sup>1,2,5</sup>	 <b>EV MODE</b>	EV drive mode indicator
 <b>HOLD</b>	Brake hold standby indicator <sup>1</sup>	 <b>EV</b>	EV indicator
 <b>BRAKE</b>	Brake system warning <sup>1,5</sup>		Fuel tank door position
 <b>(!)</b>	Brake system warning <sup>1,5</sup> [yellow]		Full-Speed Range Dynamic Radar Cruise Control (DRCC) indicator <sup>5</sup> [white/green/orange]
	BSM (Blind Spot Monitor) outside rear view mirror indicators <sup>1,4</sup>		Headlight low/high beam indicators
	Charging system warning <sup>5</sup>		High coolant temperature warning <sup>5</sup>
 <b>CUSTOM</b>	Custom mode indicator		Hybrid system overheat warning <sup>5</sup>
	Driver's and front passenger's seat belt reminder <sup>5</sup> (alarm will sound when the vehicle is on)		Inappropriate pedal operation warning <sup>5</sup>
	Driving assist information indicator <sup>1</sup>	 <b>P OFF</b>	Intuitive parking assist OFF indicator <sup>4,5</sup>





LDA (Lane Departure Alert) indicator<sup>5</sup>  
[white/green/orange<sup>3</sup>]



Low engine oil pressure warning<sup>5</sup>



Low fuel level warning



Low outside temperature indicator



Low tire pressure warning<sup>1,5</sup>



LTA (Lane Tracing Assist) indicator<sup>5</sup>  
[white/green/orange<sup>3</sup>]



Malfunction/  
Check Engine indicator<sup>1</sup>



Open door warning



Parking brake indicator<sup>2,5</sup>



PASSENGER AIR BAG ON/OFF  
indicator<sup>1</sup>



PDA (Proactive Driving Assist) indicator<sup>5</sup>  
[white/green/orange]



Pre-Collision System (PCS) warning<sup>1,2,5</sup>



READY indicator



Rear passengers' seat belt reminder<sup>5</sup>



Security indicator



Slip indicator<sup>1,3</sup>



Smart Key system indicator



Sport mode indicator



SRS airbag warning<sup>1,5</sup>



Turn signal indicator



VSC (Vehicle Stability Control) OFF  
indicator<sup>1</sup>

<sup>1</sup> If the indicator does not turn off within a few seconds of starting the vehicle, there may be a malfunction. Have the vehicle inspected by your Toyota dealer.

<sup>2</sup> If the indicator flashes, there may be a malfunction. Refer to the "Owner's Manual".

<sup>3</sup> If the indicator flashes, it indicates that the system is operating.

<sup>4</sup> If equipped.

<sup>5</sup> With warning buzzer.

# OVERVIEW

## Keyless entry

### UNLOCKING OPERATION

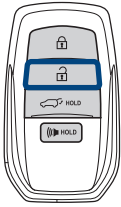

Press

ONCE: Driver door  
TWICE: All doors

Carry Smart  
Key remote

Driver door unlock\*

Grasp

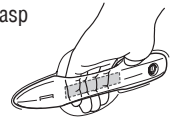

**NOTE: If a door is not opened within 60 seconds of unlocking, all doors will relock for safety.**

### LOCKING OPERATION



Press

Carry Smart  
Key remote

All-door lock

Touch



### PANIC BUTTON

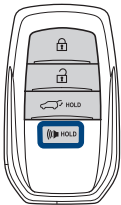

Press and hold



### BACK DOOR OPERATION (LOCKING/UNLOCKING)

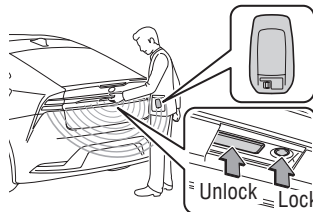

Carry Smart  
Key remote

\* Driver door unlocking function can be programmed to unlock driver door only, or all doors. Grasping passenger door handle will unlock all doors (if equipped).

*Please refer to the "Owner's Manual" for more details on how to program the doors.*

**NOTE: Doors may also be locked/unlocked using the mechanical key. (Slide the release lever on the back of Smart Key and take the mechanical key out.)**

# Smart Key system

## START FUNCTION

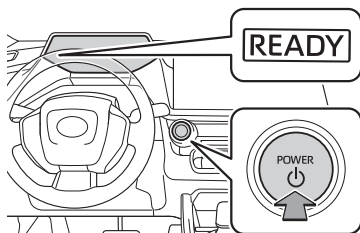

**NOTE:** The Smart Key must be carried to enable the start function. Depress the brake pedal and press the “POWER” button.

## POWER (WITHOUT STARTING VEHICLE)

Without depressing the brake pedal, pressing the power button will change the operation mode in succession from:

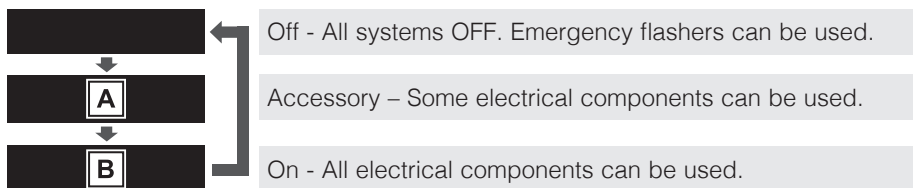

**A** - “ACCESSORY”, **B** - “IGNITION ON”

# Fuel tank door release & cap

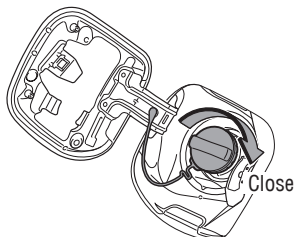
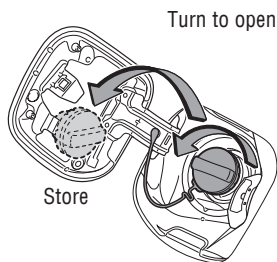
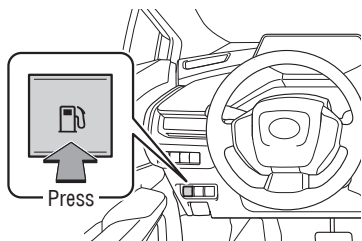

**NOTE:** Tighten until one click is heard. If the cap is not locked or tightened enough, the Check Engine indicator “” may illuminate.

## Hood release

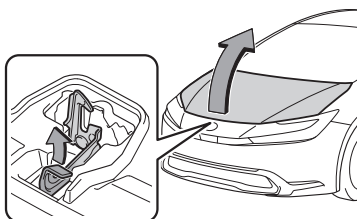
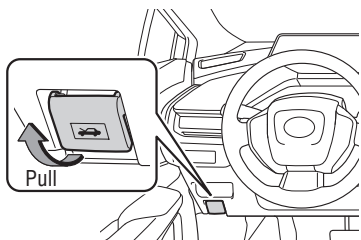

Push the lever to the left and raise the hood

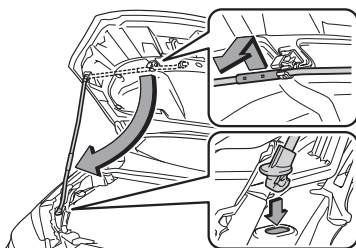

Insert support rod

## Instrument panel light control

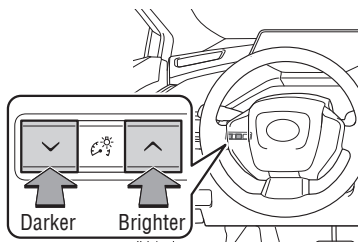

## Engine maintenance

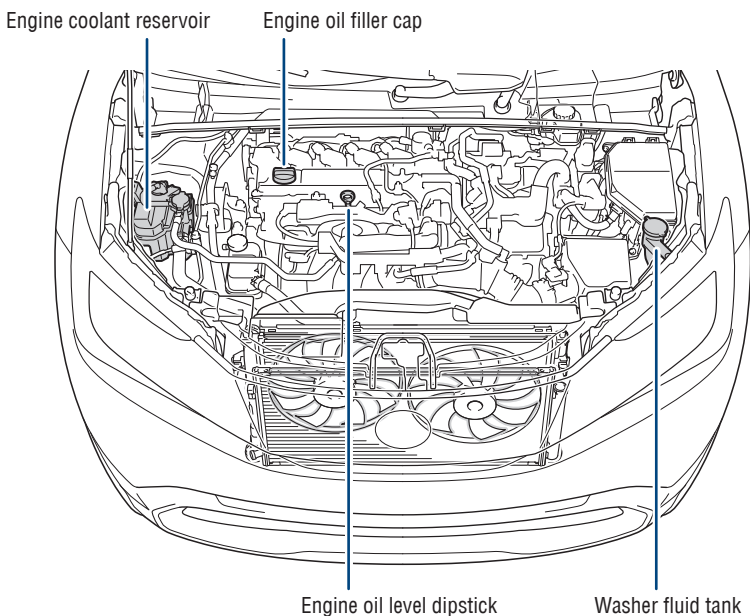

**NOTE:** Regularly scheduled maintenance at your Toyota dealer, including oil changes, will help extend the life of your vehicle and maintain performance. Please refer to the “*Warranty & Maintenance Guide.*” Maintenance reset light instructions can be found in “*Maintenance Requirements*” in “*Owner’s Manual*”.

## FEATURES & OPERATIONS

### Hybrid Synergy Drive System

The Hybrid Synergy Drive System utilizes a computer-controlled gasoline engine and electric motor to provide the most efficient combination of power for the vehicle. When the brakes are applied, the braking force generates electricity, which is then sent to the traction battery to conserve energy. In addition, the engine shuts off when the vehicle is stopped. The benefits are better fuel economy and reduced vehicle emissions.

**NOTE: Fuel consumption and energy information of the Hybrid System are shown on the Multi-Information Display (MID) and Audio Multimedia System screen.**

#### TIPS FOR IMPROVED FUEL ECONOMY

1. Ensure tire pressures are maintained at levels specified in the “Owner’s Manual”.
2. When possible, link trips to reduce engine cold starts.
3. Avoid driving at speeds that are higher than necessary, especially on the highway.
4. When possible, avoid sudden stops to maximize regenerative braking energy.
5. Minimize use of the air conditioning.

#### STARTING YOUR VEHICLE

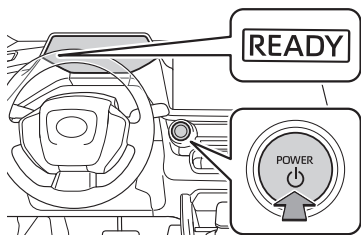

- (1) Depress the brake pedal, and “” and a message will be displayed on the Multi-Information Display (MID).
- (2) Press the power button briefly and firmly.
- (3) Continue depressing the brake pedal until the “READY” indicator is illuminated. If the “READY” indicator turns on, the hybrid system will operate normally. Shift the lever to the desired position and you may begin driving.

### EV drive mode

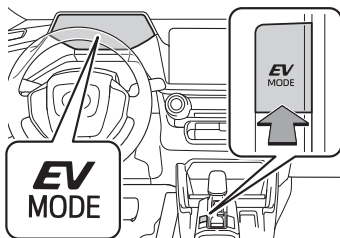

Use EV drive mode when driving short distances to reduce noise early in the morning and late at night in residential areas or to cut emissions when parking in a small garage or indoor car park.

Refer to the “Owner’s Manual” for more details.

## Hybrid transmission

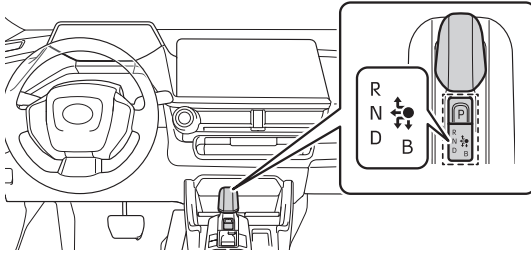

<b>P</b>	Park
<b>R</b>	Reverse
<b>N</b>	Neutral
<b>D</b>	Drive
<b>B</b>	Engine brake*

\* The engine brake is the equivalent of downshifting. Shift to “B” when engine braking is desired (i.e. downhill driving, coasting to a stop, etc.)

Refer to the “Owner’s Manual” for more details.

## Driving mode select switch

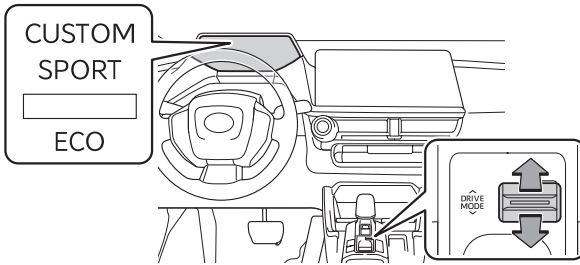

### **CUSTOM mode**

Use CUSTOM mode to allow you to drive with the power train, steering wheel, suspensions and air conditioning system functions set to your preferred settings.

### **SPORT mode**

Use Sport mode when increased acceleration response and precise handling is desired, for example, when driving on mountain roads.

### **NORMAL mode**

Use for normal driving.

### **ECO drive mode**

Use Eco drive mode to help achieve low fuel consumption during trips that involve frequent accelerating.

Refer to the “Owner’s Manual” for limitations and more details on this system.

## FEATURES & OPERATIONS

### **Auto lock/unlock**

Automatic door locks can be programmed to operate in different modes, or turned OFF.

#### DEFAULT SETTING

##### **Shift position linked door locking/unlocking function**

- Doors lock when shifting from Park.
- Doors unlock when shifting into Park.

#### CUSTOMIZED SETTING

##### **Speed linked door locking function**

- Doors lock when the vehicle speed is approximately 12 mph (20 km/h) or higher.

##### **Driver's door linked door unlocking function**

- Doors unlock when the driver's door is opened within approximately 45 seconds after turning the vehicle is turned off.

Refer to the "Owner's Manual" for more details.

### **Door lock switches**

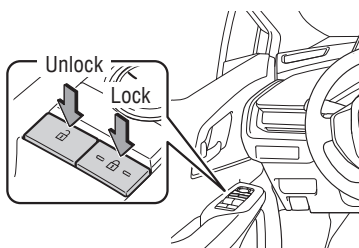



## Power windows

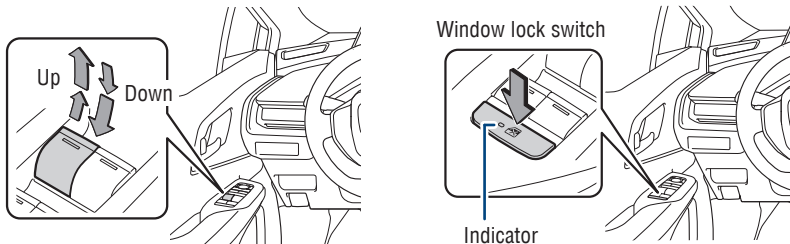

**All window auto up/down** Push the switch completely down or pull it completely up and release to fully open or close. To stop the window partway, operate the switch in the opposite direction.

**Window lock switch** Deactivates all passenger windows. Driver's window remains operable.

## Tilt & telescopic steering wheel

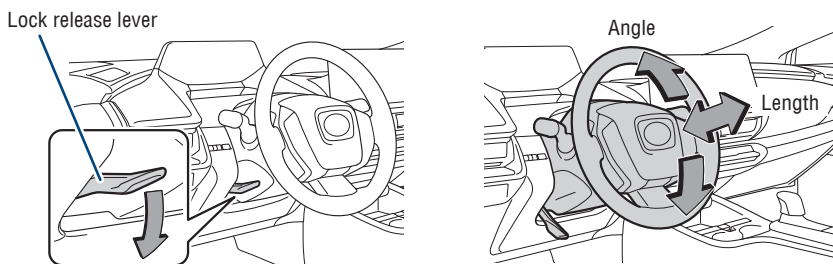

Hold the steering wheel, push the lever down, set angle and length, and return the lever.

**NOTE: Do not attempt to adjust while the vehicle is in motion.**

# FEATURES & OPERATIONS

## Front seats-Adjustments

MANUAL SEAT

POWER SEAT (FOR DRIVER'S SIDE\*)

\* If equipped

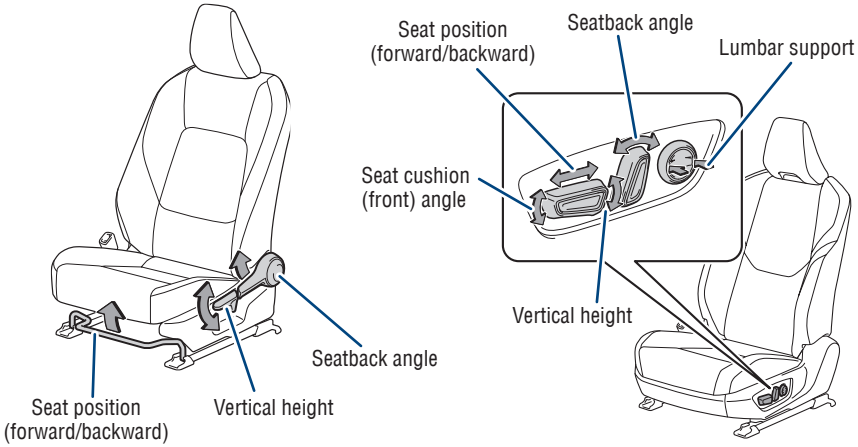

## Seats-Head restraints

Front seats

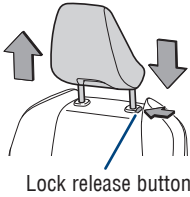

Rear center seat

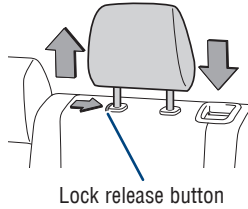

Rear outboard seats

Head restraints cannot be adjusted.

## Rear seats-Folding

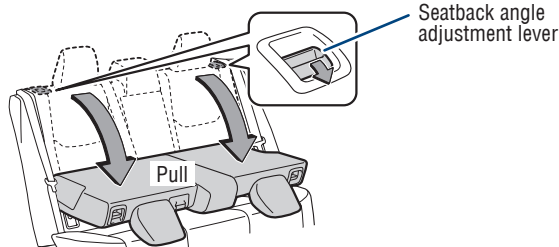

# Windshield wipers & washers

## INTERMITTENT (IF EQUIPPED)

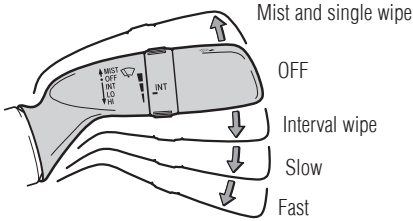

Adjust frequency<sup>1</sup>

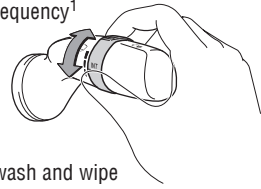

<sup>1</sup> **Intermittent windshield wiper frequency adjustment:** Rotate to increase/decrease wiper frequency.

## AUTO (RAIN-SENSING) (IF EQUIPPED)

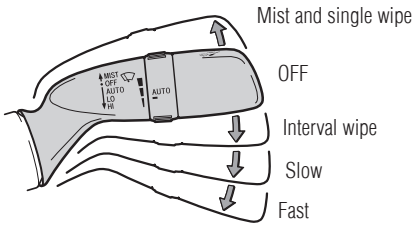

Adjust sensitivity<sup>2</sup>

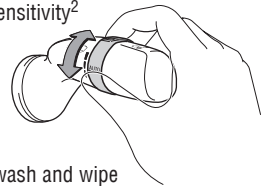



<sup>2</sup> **Rain-sensing windshield wiper sensitivity adjustment:** Rotate to increase/decrease sensor sensitivity.

Refer to the “Owner’s Manual” for more details on customizing AUTO mode operation.

# FEATURES & OPERATIONS

## Lights & turn signals

### HEADLIGHTS

Operating the  switch turns on the headlight indicator .

#### Type A

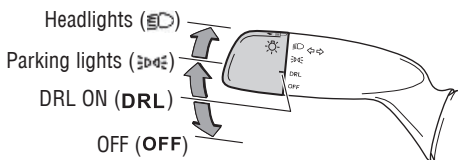

#### Type B

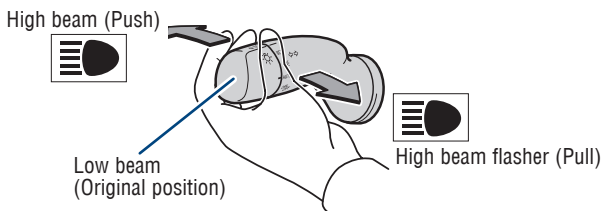
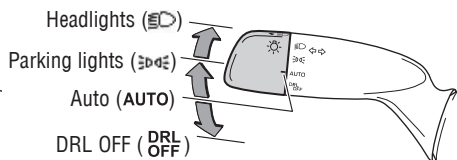

### Daytime Running Light system (DRL)

Automatically turns on under certain conditions to make vehicle more visible to other drivers. Not for use at night. (The parking brake needs to be released and the headlight switch must be in the "DRL", "OFF" or "AUTO" position while the vehicle is on.)

### Automatic light cut off system (AUTO)

- Headlights are on: The lights will turn off automatically 30 seconds after the vehicle is turned from ON to OFF and a door is opened and closed. (If the "LOCK" switch on the Smart Key remote is pressed after all doors are closed, the lights will turn off immediately.)
- Only the taillights are on: The taillights will turn off automatically if the vehicle is turned from ON to OFF and the driver's door is opened.

### Automatic High Beams system (AHB)\*

Automatically switches between high and low beams as appropriate to enhance vision at night.

Refer to Toyota Safety Sense™ 3.0 (TSS 3.0) in this guide or the "Owner's Manual" for more details on the Automatic High Beams feature.

\* Operating conditions must be met. Refer to the "Owner's Manual" for details.

### TURN SIGNALS

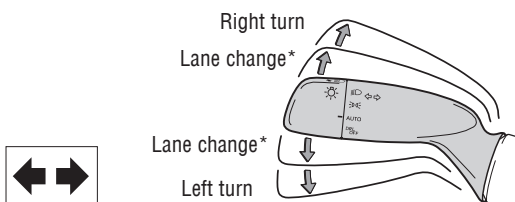

\* Move the lever partway and release. The signals will flash three times.

# Electric parking brake

## PARKING BRAKE

### Automatic mode

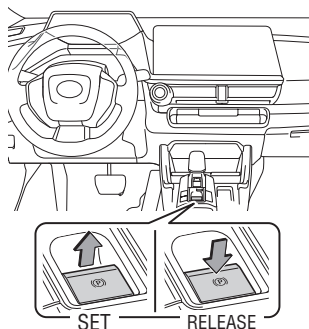

### Manual mode

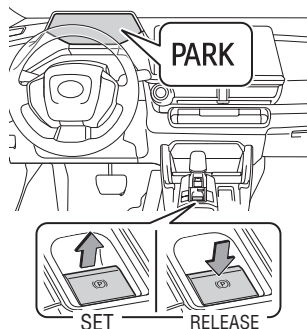

### Automatic mode

To turn automatic mode ON, while vehicle is stopped, pull and hold the parking brake switch until a buzzer sounds and a message displays on the Multi-Information Display (MID). While depressing the brake pedal, shifting the lever into P position will automatically set the parking brake and turn the parking brake indicator light on. To release brake, depress the brake pedal and shift the lever out of P. The indicator will turn off.

To turn automatic mode OFF, press and hold the parking brake switch until a buzzer sounds and a message displays on the MID.

### Manual mode

While the vehicle is stopped and the brake pedal is depressed, pull the switch to set the parking brake and turn the parking brake indicator light on. To release, depress the brake pedal and press the switch. The indicator will turn off.

Refer to the "Owner's Manual" for limitations and more details.

## BRAKE HOLD

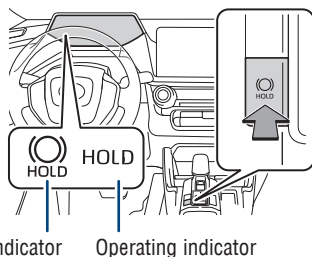





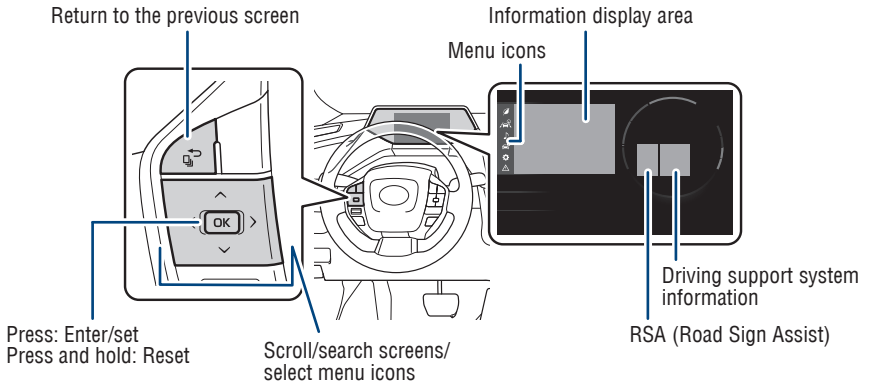

The brake hold system keeps the brake applied when the shift position is in D or N while the system is on and the brake pedal has been depressed to stop the vehicle. The system releases the brake when the accelerator pedal is depressed with the shift position in D to allow smooth start off.

Refer to the "Owner's Manual" for limitations and more details.

## Multi-Information Display (MID)



Press MID control switches to change and select information in the following:

-  Driving information display
-  Driving support system information display
-  Audio system-linked display
-  Vehicle information display
-  Settings display
-  Warning message display

Refer to the "Owner's Manual" for limitations and more details.

## Steering wheel switches & telephone controls (Bluetooth®)

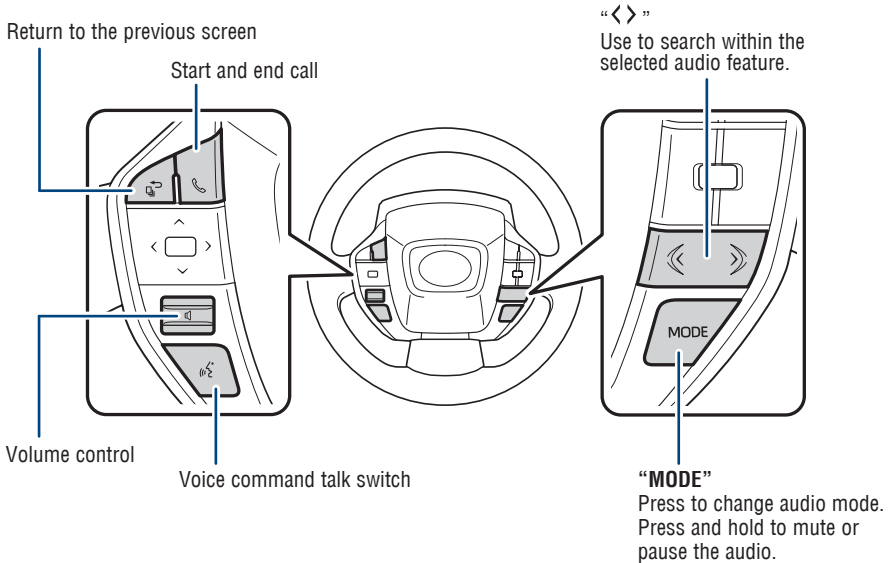

Bluetooth® technology allows dialing or receipt of calls without removing your hands from the steering wheel.

Refer to the Bluetooth® device pairing in this guide or the “Multimedia Owner’s Manual” for additional user instructions.

**NOTE: Always use safe driving practices and follow all traffic rules.**

## Clock

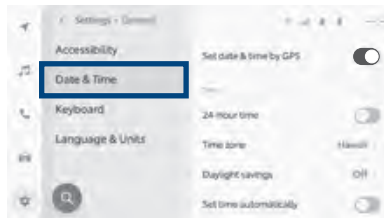

- 1) Press “⚙️” on the main menu.
- 2) Select “**General**” on the submenu.
- 3) Select “**Date & Time.**”
- 4) Select the desired items to be set.

**NOTE: It is recommended to “Set date & time by GPS” feature to ON for automatic time updates based on your location.**

Refer to the “Multimedia Owner’s Manual” for more details.

## FEATURES & OPERATIONS

### Audio Multimedia

#### VEHICLES EQUIPPED WITH 8-in DISPLAY

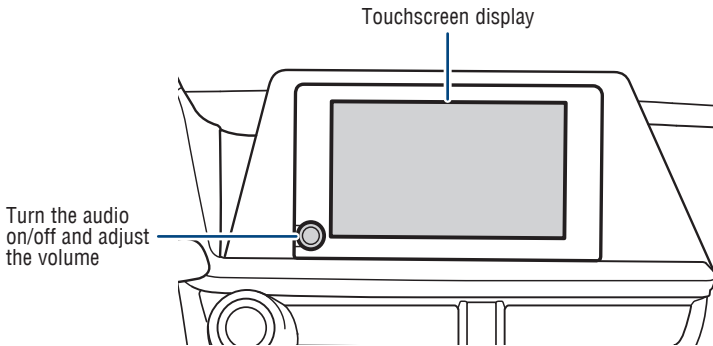

#### VEHICLES EQUIPPED WITH 12.3-in DISPLAY

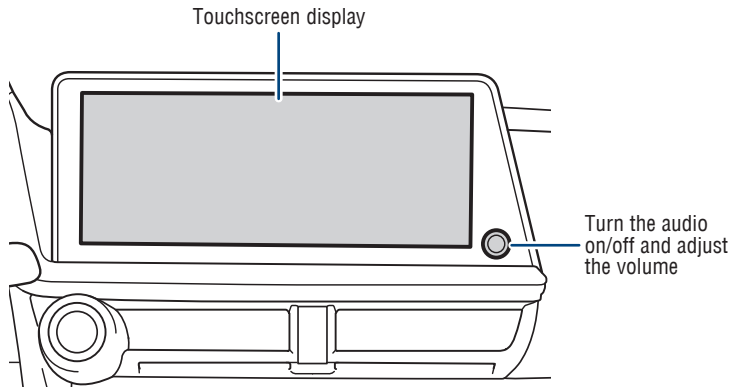

Refer to the "Multimedia Owner's Manual" or visit [www.toyota.com/audio-multimedia](http://www.toyota.com/audio-multimedia) for additional resources.

**NOTE: Always use safe driving practices and follow all traffic rules.**



## USB Type-C charge ports

FRONT

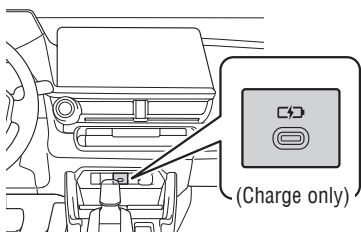

CONSOLE BOX

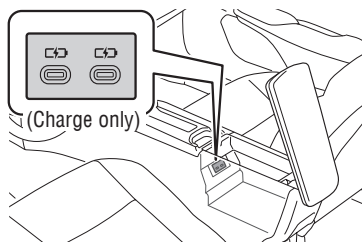

REAR

Vehicles without rear seat heater

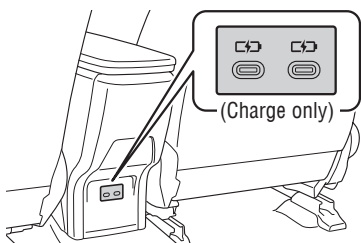

Vehicles with rear seat heater

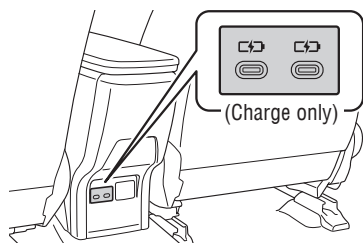

The vehicle must be in the "ACCESSORY" or "IGNITION ON" mode for use.

## USB Type-C media port

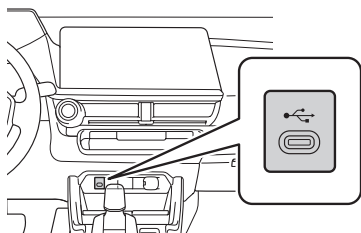

Connecting a compatible device and cable into the USB media port will support charging and music playback through the audio multimedia system.

## FEATURES & OPERATIONS

### Power outlet-12V DC

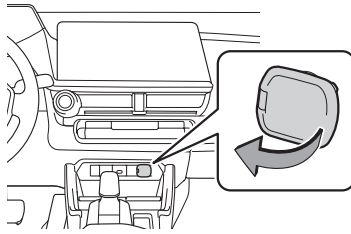

The vehicle must be in the “ACCESSORY” or “IGNITION ON” mode for use.

### Qi Wireless charger (if equipped)

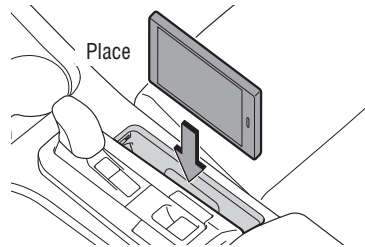
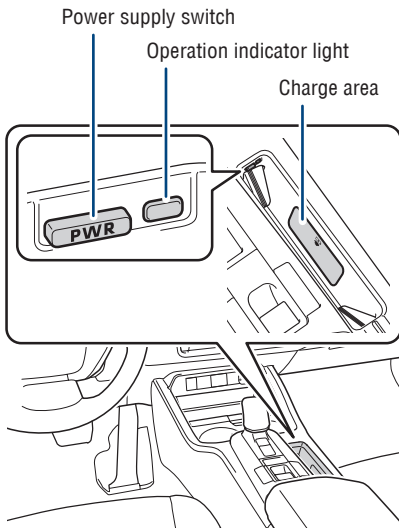

Place device nearest in the center of the charging area for best results. If the charging coil is not in the center of the device, place the device so that its charging coil is centered in the charging area.

A mobile device can be charged wirelessly on the tray. Press the wireless charger power switch and the green operation indicator light turns on. Place a compatible mobile device on the tray as shown in the illustration. An amber indicator illuminates while charging is in progress. When charging is complete, the indicator illuminates green. Some phones, cases or cover type wireless chargers may not cause the green indicator to illuminate even though it is fully charged.

*Refer to the “Owner’s Manual” for limitations and more details on this system before attempting to use it.*

# Air conditioning/heating

## AIR CONDITIONING

Rear window and outside rear view mirror defoggers\*

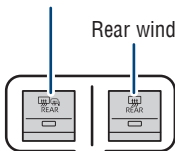

Rear window defogger\*

### Automatic mode:

Adjusting the temperature setting will cause the airflow mode, air intake and fan speed to adjust automatically to the set temperature.

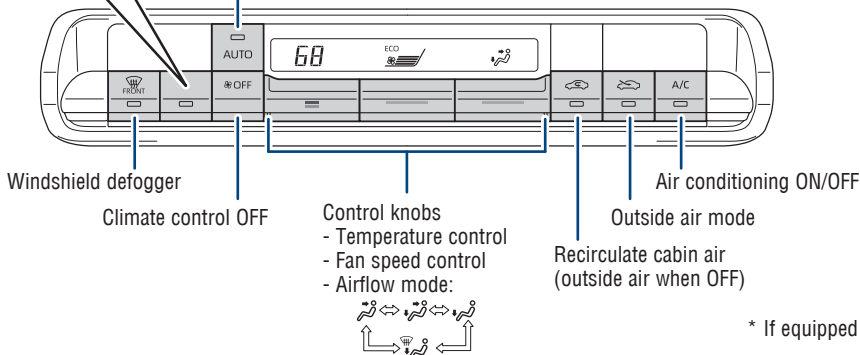

\* If equipped

## AIR CONDITIONING CONTROL SCREEN

### Air conditioning control screen

- (1) Touch "🚗" on the main manu on the multimedia display.
- (2) Select "Climate" on the sub menu.
- (3) Select the desired setting.

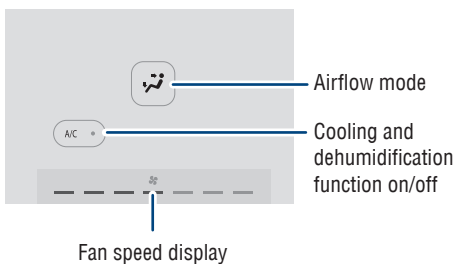
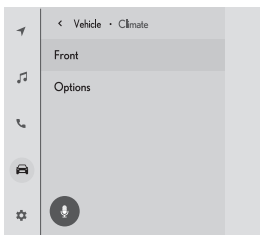

### Option control screen

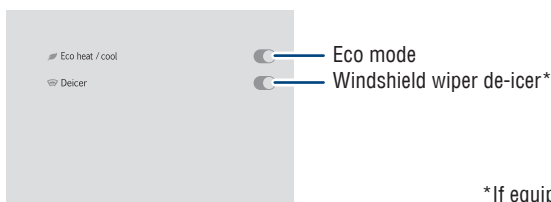

\* If equipped

## FEATURES & OPERATIONS

### **Heated/ventilated seats (if equipped)**

#### HEATED SEAT OPERATION (IF EQUIPPED)

##### Front seats

Level indicators  
(amber)

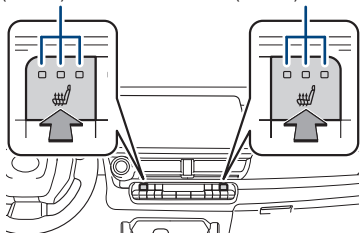

Level indicators  
(amber)

##### Outboard rear seats (if equipped)

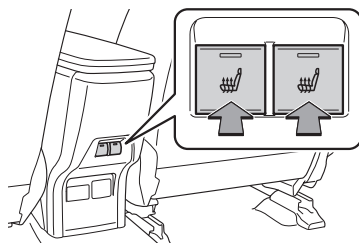

The vehicle must be on for use.

#### VENTILATED SEAT OPERATION (IF EQUIPPED)

Level indicators  
(green)

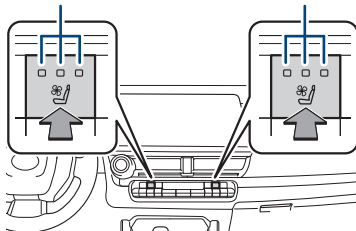

Level indicators  
(green)

The vehicle must be on for use.

### **Heated steering wheel (if equipped)**

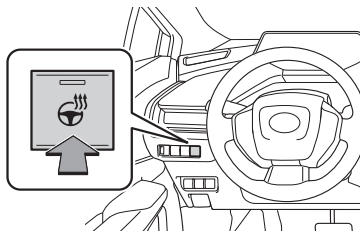

The vehicle must be on for use.

## Garage door opener (HomeLink®) (if equipped)

### VEHICLES WITH AUTO ANTI-GLARE INSIDE REAR VIEW MIRROR

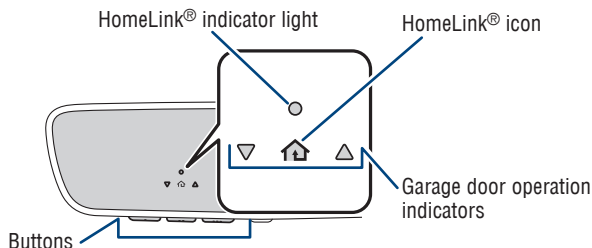

### VEHICLES WITH DIGITAL REARVIEW MIRROR

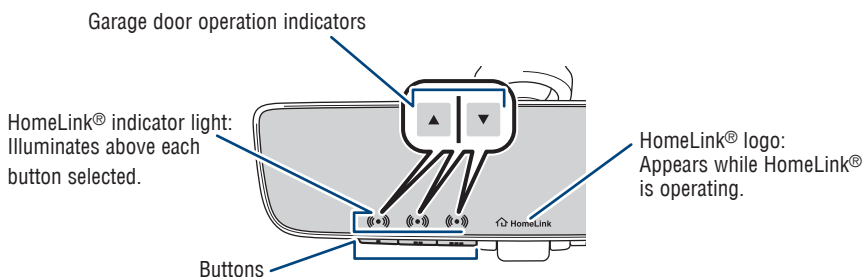

Garage door openers manufactured under license from HomeLink®\* can be programmed to operate garage doors, estate gates, security lighting, etc.

*Refer to the "Owner's Manual" for more details.*

For programming assistance, contact HomeLink® at 1-800-355-3515, or visit [www.homelink.com/toyota](http://www.homelink.com/toyota).



\* HomeLink® is a registered trademark of Gentex Corporation.

## FEATURES & OPERATIONS

### **Direct Light Illumination (if equipped)**

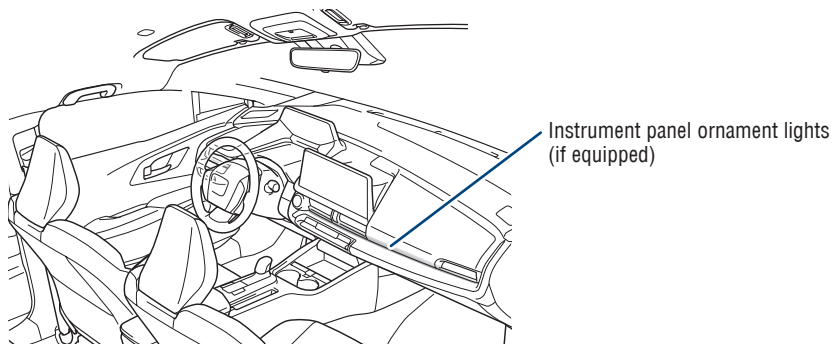

Under the following conditions, the instrument panel ornament lights blink 2 times to notify the driver.

- Preceding vehicle start notification:  
Notifies when the preceding vehicle starts off while stopped behind the preceding vehicle.
- PDA (Proactive Driving Assist) linked notifications (vehicles with PDA [Proactive Driving Assist]):  
Notifies when PDA (Proactive Driving Assist) has detected an operation target.

*Refer to the section "Illumination notification" in the "Owner's Manual" for limitations and more details.*

### **Vehicle Stability Control (VSC)/ TRAC OFF switch**

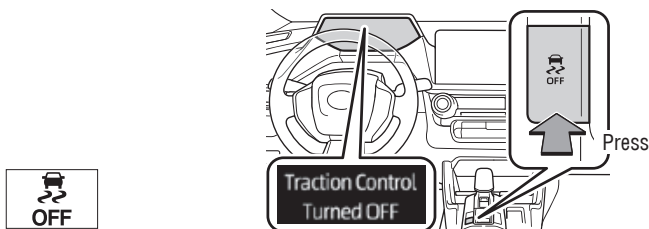

The VSC OFF switch can be used to help free a stuck vehicle in surroundings like mud, dirt or snow. While the vehicle is stopped, press the switch to disable the TRAC system.

To disable both VSC and TRAC systems, press and hold the switch for at least 3 seconds while the vehicle is stopped.

*Refer to the "Owner's Manual" for limitations and more details.*

## Rear view monitor system

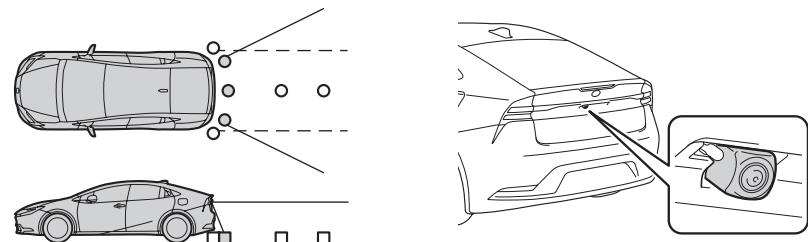

The rear view monitor system displays an image of the view from the bumper of the rear area of the vehicle. The camera for the rear view monitor system is located above the license plate.

To adjust the image on the rear view monitor screen, press “” on the main menu on the multimedia display and select “Display.” Select “Camera” to adjust the screen contrast and brightness.

Refer to the “Multimedia Owner’s Manual” for limitations and more details on this system.

## RCD (Rear Camera Detection)

The rear camera detection (RCD) feature is designed to detect pedestrians in the detection area behind the vehicle when the vehicle is backing up. If a pedestrian is detected, a buzzer will sound and an icon will be displayed on the Multimedia display to inform the driver of the pedestrian.

### DISPLAY ON AUDIO SYSTEM SCREEN

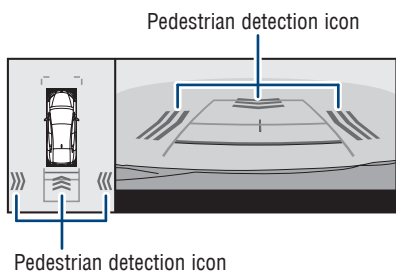

### Pedestrian detection icon:

The icon will be displayed automatically when a pedestrian is detected.

### SYSTEM ON/OFF

- (1) Press “ ” switches and select “” from the Multi-Information Display (MID).
- (2) Press “ ” switches and select “ RCD” and then press “” to turn the system On/Off.
- (3) Press “” to go back to the menu.

Refer to the “Owner’s Manual” for limitations and more details on this system before attempting to use it.

## FEATURES & OPERATIONS

### Blind Spot Monitor (BSM) and Rear Cross Traffic Alert (RCTA) (if equipped)

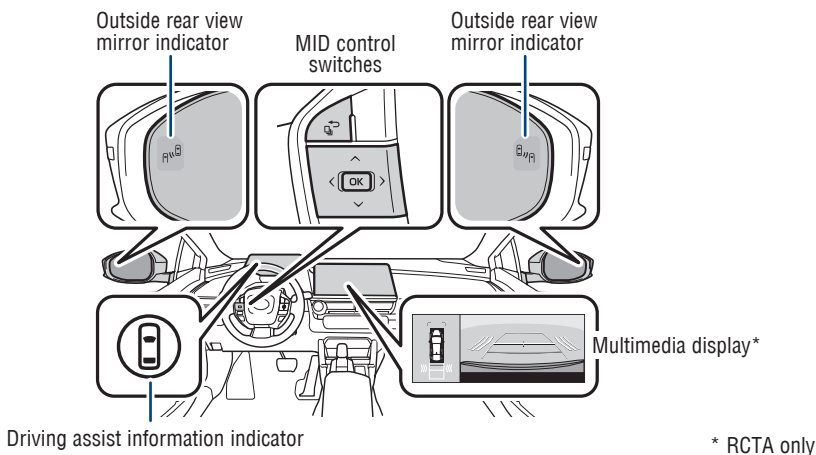

#### BLIND SPOT MONITOR (BSM)

The system is designed to use radar sensors to detect vehicles traveling in the Prius' blind spot. If a vehicle is detected, the driver will be alerted via the outside rear view mirror indicator on the detected side.

#### REAR CROSS TRAFFIC ALERT (RCTA)

While in reverse, when a vehicle approaching from the right or left rear of the Prius is detected, the outside rear view mirror indicators will flash and a buzzer will sound. Also, the RCTA icon for the detected side will be displayed on the multimedia display.

#### SYSTEM ON/OFF

- (1) Press “ ” switches and select “” from the Multi-Information Display (MID).
- (2) Press “ ” switches and select “ BSM” or “ RCTA” and then press “” to turn BSM or RCTA On/Off.
- (3) Press “” to go back to the menu.

Refer to the “Owner’s Manual” for limitations and more details on this system before attempting to use it.



## Safe Exit Assist (SEA) (if equipped)

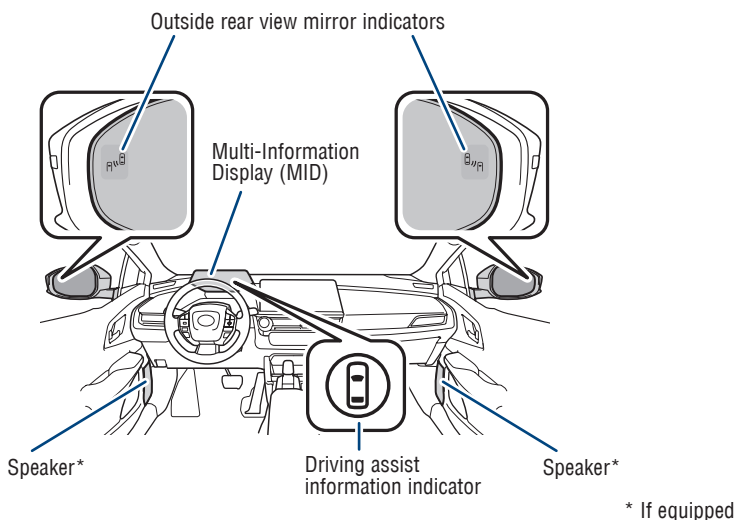

Safe Exit Assist is a system that uses rear side radar sensors installed on the inner side of the rear bumper to help warn occupants if an approaching vehicle or bicycle may collide with an opened door, before or as the door is being opened, to reduce the possibility of a collision.

### SYSTEM ON/OFF

- (1) Press “ ” switches and select “” from the Multi-Information Display (MID).
- (2) Press “ ” switches and select “ SEA” or “ Safe Exit Assist” and then press “” to turn the system On/Off.
- (3) Press “” to go back to the menu.

Refer to the “Owner’s Manual” for limitations and more details on this system before attempting to use it.

## **Panoramic View Monitor (PVM) (if equipped)**

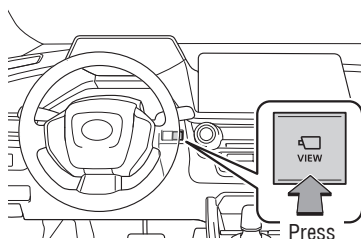

### **See-through view**

Display mode switching button

Screen off button

Voice recognition icon

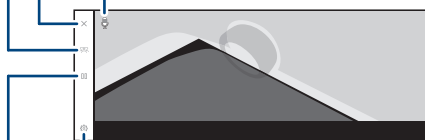

Customize settings button

Rotation pause/resume button

### **Moving view**

Display mode switching button

Screen off button

Voice recognition icon

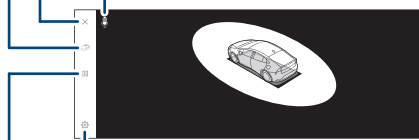

Customize settings button

Rotation pause/resume button

The Panoramic View Monitor (PVM) is designed to assist the driver in viewing the surroundings, when operating at low speeds or parking, by combining front, side and rear cameras and displaying an overhead image on the Audio Multimedia System screen.

To display the moving view/see-through view screen, press the camera switch when the shift lever is in the “P” position and the Intuitive parking assist is enabled. Press the camera switch again to display the previous display screen, such as the navigation screen.

*Refer to the “Multimedia Owner’s Manual” for limitations and more details on this system before attempting to use it.*

## Intuitive Parking Assist (if equipped)

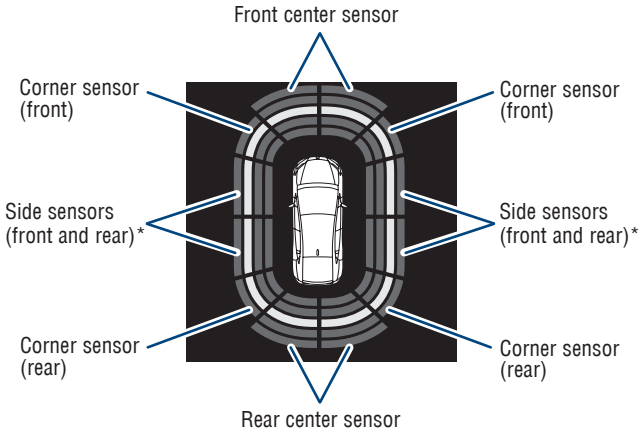

\* Available only on vehicles with Advanced Park.

The parking assist sonar system operates when the vehicle approaches an obstacle. The distance from your vehicle to nearby obstacles when parallel parking or maneuvering into a garage is measured by sensors and communicated via the Multi-Information Display (MID) and/or the multimedia display and a buzzer.

When the sensor detects an obstacle, the direction and the approximate distance to the obstacle are displayed on the MID and/or the multimedia display by illuminating continuously (far) or blinking (near), and beeping sounds will switch from intermittent to continuous as you approach and get closer to a detected obstacle. When the sensors detect two or more obstacles, the audible alerts will respond to the nearest zone.

Always check the surrounding area when using this system.

### SYSTEM ON/OFF

- (1) Press “ ” switches and select “” from the Multi-Information Display (MID).
- (2) Press “ ” switches and select “ Parking Assist” and then press “” to turn the system On/Off.
- (3) Press “” to go back to the menu.

Refer to the “Owner’s Manual” for limitations and more details on this system before attempting to use it.

## FEATURES & OPERATIONS

### **Front and Rear Parking Assist with Automatic Braking (PA w/AB) (if equipped)**

Front and Rear Parking Assist with Automatic Braking consists of the following functions that operate when driving at a low speed or backing up, such as when parking. When the system determines that the possibility of a collision with a detected object or pedestrian is high, a warning operates to urge the driver to take evasive action. If the system determines that the possibility of a collision with a detected object is extremely high, the brakes are automatically applied to help avoid the collision or help reduce the impact of the collision.

#### FUNCTIONALITY

##### For static objects front and rear

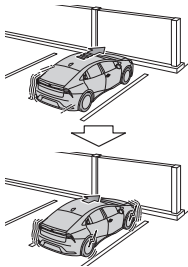

When traveling at a low speed and the brake pedal is not depressed, or is depressed late.

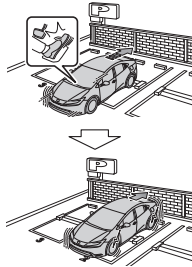

When the accelerator pedal is depressed excessively.

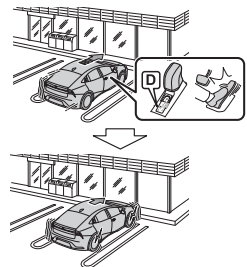

When the vehicle moves forward due to the incorrect shift position being selected.

##### For static objects around the vehicle (vehicles with the Advanced Park)

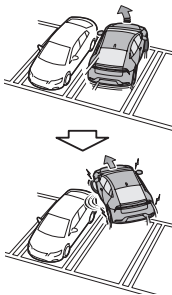

When moving forward and a collision with a stationary object on the inner side of a turn is likely.

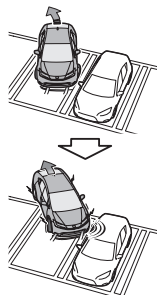

When reversing and a collision with a stationary object on the outer side of a turn is likely.

### For rear-crossing vehicles



When reversing, a vehicle is approaching and the brake pedal is not depressed, or is depressed late.

### For rear pedestrians

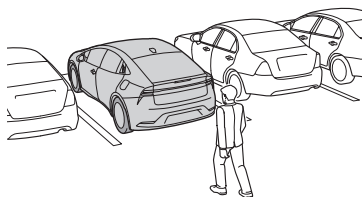

When an approaching pedestrian is detected behind the vehicle while backing up, and when the brake pedal is not depressed or is depressed late.

The pedestrian detection area differs from the Rear Camera Detection (RCD)\*. Therefore in certain circumstances, RCD may detect a pedestrian, but automatic braking may not occur.

\* If equipped

### SYSTEM ON/OFF

- (1) Press “ ” switches and select “” from the Multi-Information Display (MID).
- (2) Press “ ” switches and select “ PKSB” and then press “” to turn the system On/Off.
- (3) Press “” to go back to the menu.

*Refer to the section “Parking Support Brake function” (“static objects to the front and rear”, “static objects around the vehicle”, “rear-crossing vehicles” and “rear pedestrians”) in the “Owner’s Manual” for limitations and more details.*

## FEATURES & OPERATIONS

### **Advanced Park (if equipped)**

Advanced Park is designed to assist in safely and smoothly parking in a target parking space by displaying the blind spots around the vehicle and the parking spot through a bird's eye view, delivering operation guidance through displays and buzzer operation, and changing the shift position, operating the steering wheel, accelerator pedal, and brake pedal. Advanced Park does not operate the turn signal.

Additionally, the panoramic view monitor can display the area in front, behind, and from above the vehicle, helping confirm the condition of the area around the vehicle.

Depending on the condition of the road surface or the vehicle, the distance between the vehicle and a parking space, etc., it may not be possible to assist in parking in the target space.

#### FUNCTIONALITY

- Perpendicular parking (forward/reverse) function
- Perpendicular exiting (forward/reverse) function
- Parallel parking function
- Parallel exiting function
- Memory function

#### CAMERAS

##### Front camera

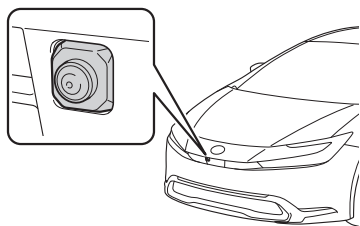

##### Side cameras

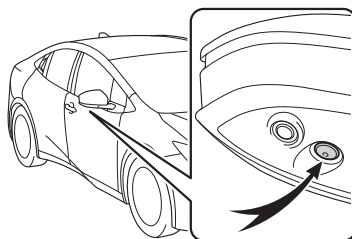

##### Rear camera

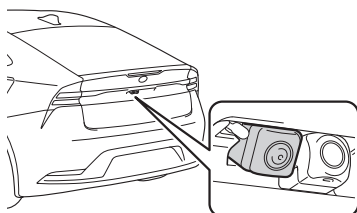

## SYSTEM ON/OFF MAIN SWITCH

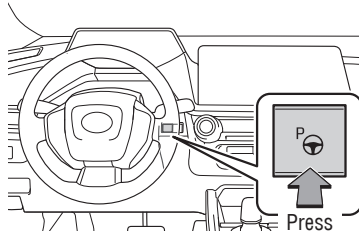

## CONDITIONS WHERE ASSISTANCE WILL BEGIN

When all of the following conditions are met, the assistance will begin:

- The brake pedal is depressed
- The vehicle is stopped
- The driver's seat belt is fastened
- The steering wheel is not being operated
- The accelerator pedal is not depressed
- All of the doors and the trunk are closed
- The outside rear view mirrors are not folded
- The parking brake is not engaged
- The dynamic radar cruise control with full-speed range is not operating
- ABS, VSC, TRAC, PCS and PKSB are not operating
- The vehicle is not on a steep slope
- The VSC and TRAC are not turned off

*Refer to the "Owner's Manual" and "Multimedia Owner's Manual" for limitations and more details on this system before attempting to use it.*

## Quick overview-Toyota Safety Sense™ 3.0

Toyota Safety Sense™ 3.0 (TSS 3.0) is a set of active safety technologies designed to help mitigate or prevent collisions across a wide range of traffic situations, in certain conditions. TSS 3.0 is designed to help support the driver's awareness, decision making and vehicle operation contributing to a safe driving experience.

**Refer to the "Owner's Manual" for operation, setting adjustments, limitations and more details to understand these functions and complete safety precautions.**

**For more information, please go to [www.toyota.com/safety-sense](http://www.toyota.com/safety-sense).**



### **Pre-Collision System with Pedestrian Detection (PCS w/PD)**

PCS w/PD is designed to provide alert, mitigation, and/or avoidance support in certain conditions, when the system determines there is potential for a collision with a detected object.

The advanced front radar system is designed to work with the forward-facing camera to help recognize a preceding vehicle, bicyclist, pedestrian or motorcycle in certain conditions.



### **Lane Tracing Assist (LTA)**

When driving on a road with clear lane lines with the dynamic radar cruise control operating, Lane Tracing Assist detects the lane lines and preceding and surrounding vehicles using the front camera and radar sensor, and operates the steering wheel to maintain the vehicle's lane position. LTA requires the driver to grip the steering wheel.

When LTA is activated, if the system does not detect driving operations, such as if the driver is not holding the steering wheel, and determines the driver is not responsive, the Emergency Driver Support System (EDSS) is designed to decelerate the vehicle to a stop within its current lane to help avoid or mitigate a possible collision.



### **Lane Departure Alert (LDA) with Steering Assist**

LDA uses the front camera to detect lane lines or other roadway boundaries. This system warns the driver if the vehicle may deviate from the current lane or course and also can slightly operate the steering wheel to help avoid deviation from the lane or course. If LDA detects that the vehicle is swaying, a message will be displayed and a warning buzzer will sound to urge the driver to take a break.



### **Full-Speed Range Dynamic Radar Cruise Control (DRCC)**

Full-Speed Range DRCC is designed to help maintain a pre-set distance to a preceding vehicle when the preceding vehicle is traveling at a lower speed.



### **Automatic High Beams (AHB)**

AHB is designed to detect the headlights of oncoming vehicles and the taillights of preceding vehicles and switch between high beams and low beams as appropriate.





### Road Sign Assist (RSA)

RSA is designed to recognize specific road signs using the forward-facing camera to provide information to the driver via the display.



### Proactive driving assist (PDA)

When system operating conditions are met, using the vehicle's camera and radar, Proactive Driving Assist (PDA) provides gentle braking into curves or gentle braking and/or steering to help control distance between your vehicle and a preceding vehicle, pedestrian, bicyclist or motorcycle.

## Over-The-Air (OTA) Updates

Toyota Safety Sense 3.0 is capable of over-the-air updates. To use this function it is necessary to opt-in to the Connected Service Master Data Consent. When the Toyota Safety Sense 3.0 software is updated, the operating methods of functions may change. Before using the system, make sure to read the Digital Owner's Manual corresponding to the current software version, available at [www.toyota.com/owners/resources/warranty-owners-manuals](http://www.toyota.com/owners/resources/warranty-owners-manuals).

## Sensors

TSS 3.0 combines a forward-facing camera mounted in front of the inside rear view mirror and a front grill-mounted radar. These sensors support the driving assist systems.

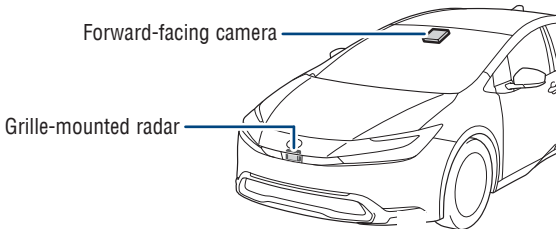

## **Pre-Collision System with Pedestrian Detection (PCS w/PD)**

The Pre-Collision System with Pedestrian Detection (PCS w/PD) is designed to help detect a vehicle, bicyclist, pedestrian or motorcycle in certain situations. Using both a camera and front radar, PCS w/ PD can provide an audio/visual alert to warn you of a possible collision under certain circumstances. If you don't react, the system is designed to automatically brake.

As there is a limit to the degree of recognition accuracy and control performance that this system can provide, do not overly rely on this system. This system will not prevent collisions or lessen collision damage or injury in every situation. Do not use PCS instead of normal braking operations under any circumstances. Do not attempt to test the operation of the Pre-Collision System yourself, as the system may not operate or engage, possibly leading to an accident. In some situations, such as when driving in inclement weather such as heavy rain, fog, snow or a sandstorm or while driving on a curve and for a few seconds after driving on a curve, a vehicle, bicyclist, pedestrian or motorcycle may not be detected by the radar and camera sensors, preventing the system from operating or engaging properly.

*Refer to the Toyota "Owner's Manual" for a list of additional situations in which the system operation may be limited.*

### **Pre-Collision Warning**

When the system determines that the possibility of a frontal collision is high, a buzzer will sound and an icon and warning message will be displayed on the Multi-Information Display (MID) to urge the driver to take evasive action.

### **Pre-Collision Brake Assist**

If the driver notices the hazard and brakes, the system may provide additional braking force using Brake Assist. This system may prime the brakes and may apply greater braking force in relation to how strongly the brake pedal is depressed.

### **Pre-Collision Brake Control**

If the driver does not brake in a set time and the system determines that the possibility of a collision with a preceding vehicle is extremely high, the system may automatically apply the brakes, reducing speed in order to help the driver reduce the impact and in certain cases avoid the collision.

*See [www.toyota.com/safety-sense](http://www.toyota.com/safety-sense) for more information.*

## PCS PEDESTRIAN DETECTION

Under certain conditions, the PCS included with TSS 3.0 may also help to detect a pedestrian, bicyclist or motorcycle in front of your vehicle using the forward-facing camera and the front radar sensor. The forward-facing camera of PCS detects a potential pedestrian, bicyclist or motorcycle based on size, profile, and motion of the detected pedestrian, bicyclist or motorcycle. However, a pedestrian, bicyclist or motorcycle may not be detected depending on the conditions, including the surrounding brightness and the motion, posture, size, and angle of the potential detected pedestrian, bicyclist or motorcycle, preventing the system from operating or engaging.

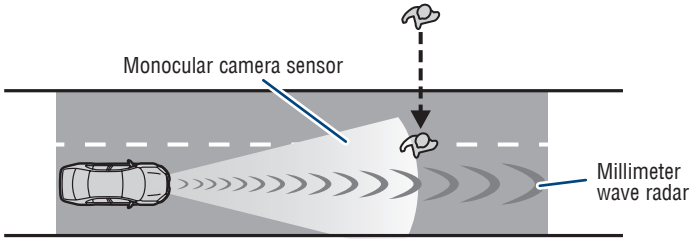

As part of the Pre-Collision System, this function is also designed to first provide an alert and then automatic braking if needed.

Refer to the Toyota "Owner's Manual" for additional limitations and information.

## CHANGING PCS WARNING TIMING

- (1) Press "**▲ ▼**" switches and select "**⚙️**" from the Multi-Information Display (MID).
- (2) Press "**◀ ▶**" switches and select "**🚗 PCS**" and then press and hold "**OK**." The setting screen is displayed.
- (3) Press "**◀ ▶**" switches and select "Warning timing" and then press "**OK**" to change the desired setting. Each time it is pressed, the PCS warning timing changes "Later" or "Default" or "Earlier."
- (4) Press "**↶**" to go back to the menu.

**Note: PCS is enabled each time the vehicle is turned on. The system can be disabled/enabled and the alert timing of the system can be changed. (Alert timing only, brake operation remains the same.)**

# TOYOTA SAFETY SENSE™

## DISABLING PRE-COLLISION SYSTEM (PCS)

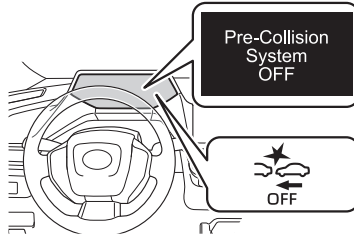

- (1) Press "▲▼" switches and select "⚙️" from the Multi-Information Display (MID).
- (2) Press "◀▶" switches and select "🚗 PCS" and then press and hold "OK."
- The setting screen is displayed.
- (3) Press "◀▶" switches and select "🚗 PCS" and then press "OK" to turn PCS On/Off.
- (4) Press "↶" to go back to the menu.









*Refer to the Toyota "Owner's Manual" for additional information on PCS w/PD operation, settings adjustments, limitations, and precautions before attempting to use it.*

## Lane Tracing Assist (LTA)

When driving on a road with clear lane lines with the dynamic radar cruise control operating, Lane Tracing Assist detects the lane lines and preceding and surrounding vehicles using the front camera and radar sensor, and operates the steering wheel to maintain the vehicle's lane position. LTA requires the driver to grip the steering wheel.

When LTA is activated, if the system does not detect driving operations, such as if the driver is not holding the steering wheel, and determines the driver is not responsive, the Emergency Driver Support System (EDSS) is designed to decelerate the vehicle to a stop within its current lane to help avoid or mitigate a possible collision.

Operation of the Lane Tracing Assist function is indicated by the following icons on the instrument cluster.

Indicator	Lane display	Steering icon	Situation
 White	 Gray/White	 Gray	LTA is on standby
 Green	 Green	 Green	LTA is operating
 Orange Flashing	 Orange Flashing	 Green	The vehicle is departing the lane toward the side which the lane display is flashing

Refer to the Toyota "Owner's Manual" for additional information on LTA operation, settings adjustments, limitations, and precautions before attempting to use it.

### TURNING LANE TRACING ASSIST (LTA) ON/OFF

**Press the LTA switch to turn LTA ON/OFF.**

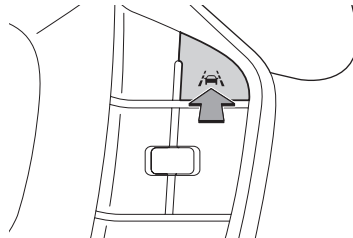

**Note:** Operation of LTA and setting adjustments continues in the same condition regardless of power switch modes until changed by the driver or the system is reset. The LTA indicator is illuminated when LTA is on.

## Lane Departure Alert (LDA) with Steering Assist

### LANE DEPARTURE ALERT (LDA) WITH STEERING ASSIST

By detecting visible lane markings or the road's edge at speeds above 30 mph, Lane Departure Alert (LDA) with Steering Assist is designed to issue a visual alert and audio or steering vibration alert if an inadvertent lane departure is detected. If the driver does not take corrective action, the Steering Assist function is designed to provide gentle corrective steering.\* If LDA detects that the vehicle is swaying, a message will be displayed and a warning buzzer will sound to urge the driver to take a break.

\* See [www.toyota.com/safety-sense](http://www.toyota.com/safety-sense) for more information and limitations.

#### Lane departure alert function

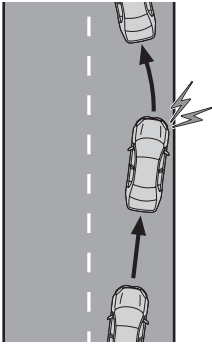

#### Lane departure prevention function

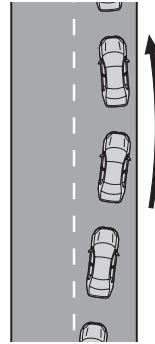



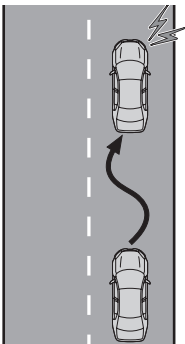









#### Break suggestion function (Sway Warning)







## LANE DEPARTURE ALERT (LDA) WITH STEERING ASSIST (CONTINUED)

Operation of the Lane Departure Alert function is indicated by the following icons on the instrument cluster.

Indicator	Lane display	Steering icon	Operation
Not illuminated	Not illuminated	Not illuminated	System disabled
 White	 Gray	Not illuminated	Lane lines are not detected by the system
 White	 White	Not illuminated	Lane lines are detected by the system
 Orange Flashing	 Orange Flashing	Not illuminated	Lane departure alert function is operating for the side which the lane display is flashing
 Green	 Green	 Green	Lane departure prevention function is operating for the side which the lane display is illuminated
 Orange Flashing	 Orange Flashing	 Green	Lane departure alert function/lane departure prevention function is operating for the side which the lane display is flashing













## TURNING LDA ON/OFF

- Press “   













OVERVIEW

# TOYOTA SAFETY SENSE™













## ADJUSTING LDA ALERT TIMING

- (1) Press “ ” switches and select “” from the Multi-Information Display (MID).
- (2) Press “ ” switches and select “ LDA” or “ Lane Departure Alert System” and then press and hold “.” The setting screen is displayed.
- (3) Press “ ” switches and select “Alert Timing” and then press “” to change the desired setting. Each time it is pressed, the LDA alert timing changes “Default” or “Earlier.”
- (4) Press “” to go back to the menu.

## ADJUSTING LDA ALERT OPTIONS

- (1) Press “ ” switches and select “” from the Multi-Information Display (MID).
- (2) Press “ ” switches and select “ LDA” or “ Lane Departure Alert System” and then press and hold “.” The setting screen is displayed.
- (3) Press “ ” switches and select “Alert Options” and then press “” to change the desired setting. Each time it is pressed, the LDA alert options changes “Vibration” or “Beep.”
- (4) Press “” to go back to the menu.

## TURNING THE DRIVER BREAK SUGGESTION (SWAY WARNING) ON/OFF

- (1) Press “ ” switches and select “” from the Multi-Information Display (MID).
- (2) Press “ ” switches and select “ Vehicle Settings” and then press and hold “.” The setting screen is displayed.
- (3) Press “ ” switches and select “ Driver Break Suggestion” and then press “” to turn the system On/Off.
- (4) Press “” to go back to the menu.

*Refer to the Toyota “Owner’s Manual” for additional information on LDA operation, settings adjustments, limitations, and precautions before attempting to use it.*



# Full-Speed Range Dynamic Radar Cruise Control (DRCC)

Intended for highway use, Full-Speed Range Dynamic Radar Cruise Control (DRCC) lets you drive at a preset speed, with a minimum set speed of approximately 20 mph. The system uses vehicle-to-vehicle distance control, helping maintain a preset distance from the vehicle ahead of you.\*

\* See [www.toyota.com/safety-sense](http://www.toyota.com/safety-sense) for more information

Refer to the Toyota "Owner's Manual" for a list of additional situations in which the system operation may be limited.

## Meter display

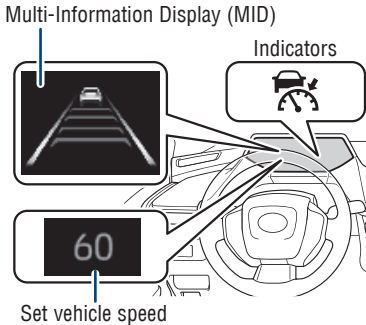

## Switches

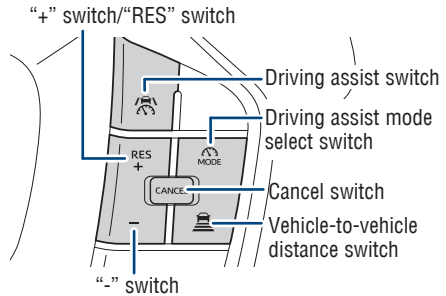

## ACTIVATING DRCC

(1)

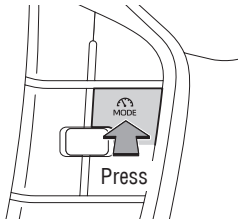

(2)

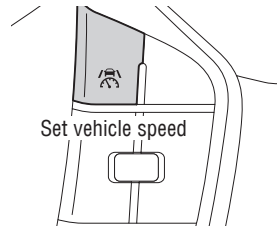

The vehicle will cruise at a set vehicle speed, decelerate to maintain a selected distance from a slower preceding vehicle and accelerate back up to the selected speed if the vehicle in front changes lanes or speeds up.

- (1) Press "MODE" switch to select DRCC. The dynamic radar cruise control indicator " " will illuminate and the message "Adaptive Cruise Mode" will be displayed on the MID.
- (2) Using the accelerator pedal, accelerate or decelerate to the desired vehicle speed (approximately 20 mph [30 km/h] or more), and press " " switch to set the set vehicle speed. The set vehicle speed will be displayed on the Multi-Information Display (MID).

# TOYOTA SAFETY SENSE™

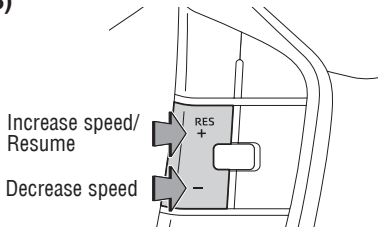

## ADJUSTING SET VEHICLE SPEED

(3)

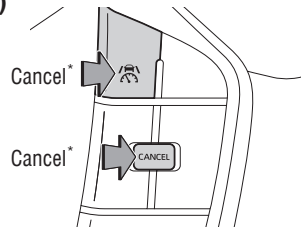

(4)



- (3) To change the set vehicle speed, press the “+” (increase) or “-” (decrease) switch until the desired speed is displayed. Press and hold to continuously adjust the speed in 1 mph (1.6 km/h) increments, or use a single press to adjust in individual increments of 1 mph (1.6 km/h).
- (4) Press “” switch or “” switch to cancel the speed control. (Press the “” switch to resume control.)

\* The speed control may also be canceled by depressing the brake pedal.

## ADJUSTING DISTANCE

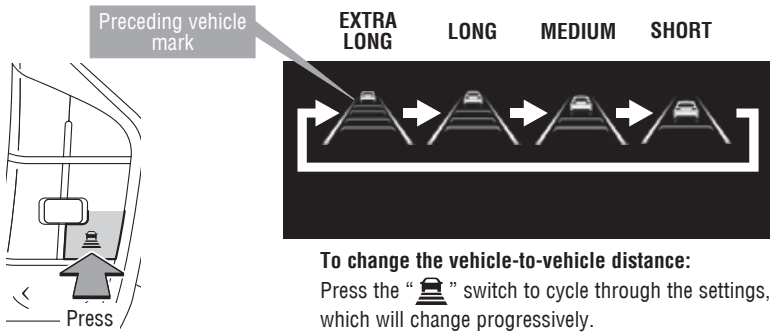

The actual vehicle-to-vehicle distance varies in accordance with the vehicle speed. Also, when the vehicle is stopped by system control, it will be stopped at a certain distance from the preceding vehicle, depending on the situation, regardless of the setting.

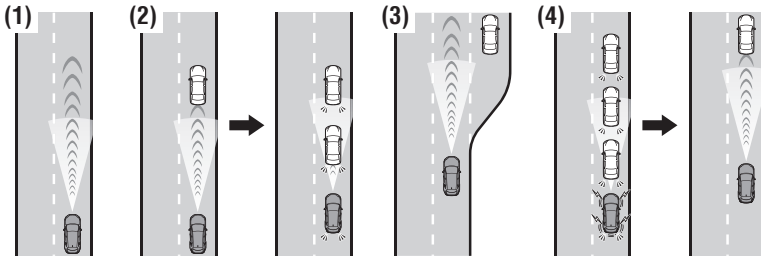

(1) **Constant speed cruising when there are no vehicles ahead**

The vehicle travels at the speed set by the driver. If the set vehicle speed is exceeded while driving down a hill, the set vehicle speed display will blink and a buzzer will sound.

(2) **Deceleration cruising and follow-up cruising when a preceding vehicle driving slower than the set vehicle speed is detected**

When a slower vehicle is detected running ahead of your vehicle, the vehicle automatically decelerates and if a greater reduction in vehicle speed is necessary, the brakes may be applied (the brake lights will come on at this time). The vehicle is controlled to maintain the vehicle-to-vehicle distance set by the driver, in accordance with changes in the speed of the preceding vehicle. If vehicle deceleration is not sufficient and the vehicle approaches the vehicle ahead, the approach warning will sound.

(3) **Acceleration when there are no longer any preceding vehicles driving slower than the set vehicle speed**











The vehicle accelerates until the set vehicle speed is reached and then resumes constant speed cruising.

(4) **Starting off**

If a preceding vehicle stops, the vehicle will also stop (controlled stop). After the preceding vehicle starts off, pressing the "RES" switch or depressing the accelerator pedal will resume follow-up cruising (start off operation). If a start off operation is not performed, the controlled stop will continue.

**Note: When your vehicle is too close to a vehicle ahead, and sufficient automatic deceleration via the cruise control is not possible, the display will flash and the buzzer will sound to alert the driver. An example of this would be if another driver cuts in front of you while you are following a vehicle. Depress the brake pedal to ensure an appropriate vehicle-to-vehicle distance.**

## ADDITIONAL DRCC SETTINGS

- (1) Press “ ” switches and select “” from the Multi-Information Display (MID).
- (2) Press “ ” switches and select “ DRCC” and then press “.”  
The setting screen is displayed.
- (3) Press “ ” switches to select a DRCC setting from the menu, and the press “” to change the desired setting.
- (4) Press “” to go back to the menu.

Refer to the Toyota “Owner’s Manual” for additional information on DRCC operation, settings adjustments, limitations, and precautions before attempting to use it.

## Cruise Control

Intended for highway use, Cruise Control lets you drive at a preset speed. The system is designed to function at speeds greater than 20 mph.\*

\* See [www.toyota.com/safety-sense](http://www.toyota.com/safety-sense) for more information

Refer to the Toyota “Owner’s Manual” for a list of additional situations in which the system operation may be limited.

### Meter display

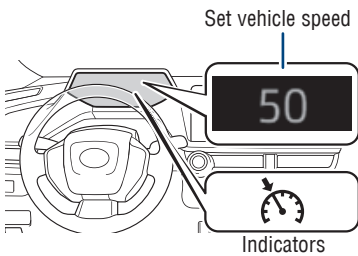

### Switches

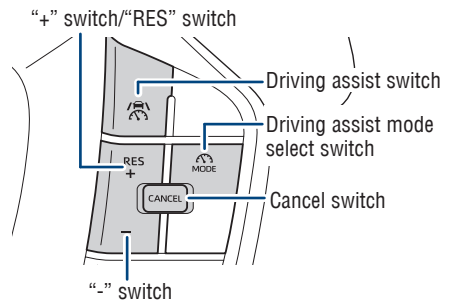

## ACTIVATING CRUISE CONTROL

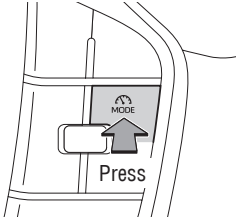

(1)

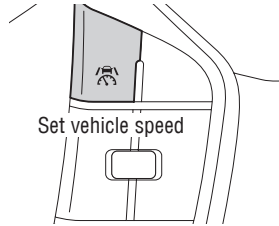

(2)



Vehicle will cruise at a set vehicle speed.

- (1) Press “MODE” switch to select “Cruise Control Mode.” The cruise control indicator  will illuminate.
- (2) Using the accelerator pedal, accelerate or decelerate to the desired vehicle speed (approximately 20 mph [30 km/h] or more), and press “” switch to set the set vehicle speed. The set vehicle speed will be displayed on the Multi-Information Display (MID).

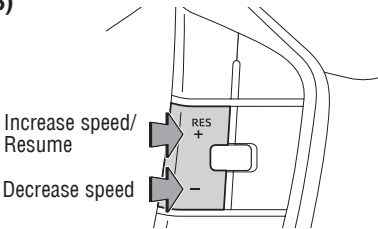

## ADJUSTING SET VEHICLE SPEED

(3)

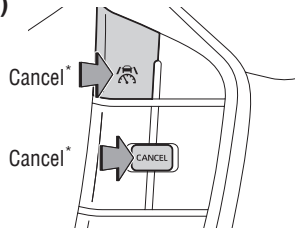

(4)



- (3) To change the set vehicle speed, press the “+” (increase) or “-” (decrease) switch until the desired speed is displayed. Press and hold to continuously adjust the speed in 1 mph (1.6 km/h) increments, or use a single press to adjust in individual increments of 1 mph (1.6 km/h).
- (4) Press “” switch or “” switch to cancel the speed control. (Press the “” switch to resume control.)

\* The speed control may also be canceled by depressing the brake pedal.

**Note: NOTE: On steep downhills, or where there are sudden changes between sharp up and down gradients, vehicle speed may exceed the set speed when driving down a steep hill.**

Refer to the Toyota “Owner’s Manual” for additional information on Cruise Control operation, settings adjustments, limitations, and precautions before attempting to use it.

## Automatic High Beams (AHB)

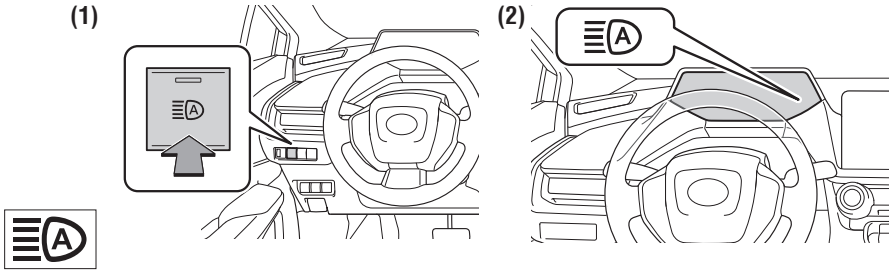

The Automatic High Beams (AHB) safety system is designed to help the driver see more clearly at night. At speeds above 21 mph, AHB can detect the headlights of oncoming vehicles and taillights of preceding vehicles, then automatically toggles between high and low beams accordingly.

See [www.toyota.com/safety-sense](http://www.toyota.com/safety-sense) for more information.

Refer to the Toyota “Owner’s Manual” for additional information on AHB operation, settings adjustments, limitations, and precautions before attempting to use it.

### ACTIVATING THE AHB SYSTEM

(1) Press the “” switch.

(2) Turn the headlight switch to the “” or “**AUTO**” position.

The AHB indicator “” will come on when the headlights are on and the headlight switch lever is in the low beam position to indicate the system is active.

**Note: Push the lever away from you to manually turn on high beams. Press the AHB switch to turn the AHB system off.**

### CONDITIONS WHERE AHB WILL TURN ON/OFF AUTOMATICALLY

When all of the following conditions are met, the high beams will be automatically turned on (after approximately 1 second):

- Vehicle speed is approximately 21 mph (34 km/h) or more.
- The area ahead of the vehicle is dark.
- There are no oncoming or preceding vehicles with headlights or taillights turned on.
- There are few streetlights or other lights on the road ahead.

If any of the following conditions occur, the high beams will be automatically turned off:

- Vehicle speed drops below approximately 17 mph (27 km/h).
- The area ahead of the vehicle is not dark.
- Oncoming or preceding vehicles have headlights or taillights turned on.
- There are many streetlights or other lights on the road ahead.

## TEMPORARILY SWITCHING TO THE LOW BEAMS

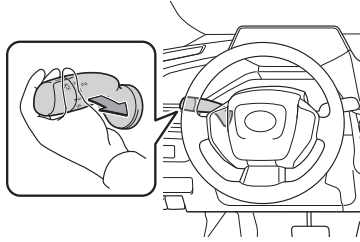

Pull the lever toward you and then return it to its original position to switch to the low beams temporarily.

The high beams are on while the lever is pulled toward you. However, after the lever is returned to its original position, the low beams remain on for a certain period of time. Afterwards, the Automatic High Beams will be activated again.

**NOTE: It is recommended to switch to the low beams when use of the high beams is inappropriate or the high beams may cause problems or distress to other drivers or pedestrians nearby.**

## Road Sign Assist (RSA)

Using the forward-facing camera and navigation system (if equipped), Road Sign Assist (RSA) is designed to detect certain road signs and display them on the instrument cluster.

*All vehicle actions must be driver-initiated and are not automated. Refer to the Toyota "Owner's Manual" for additional information and limitations.*

### SUPPORTED TYPES OF ROAD SIGNS

The following types of road signs can be displayed.



Speed limit



Do Not Enter



No U-turn



No Turn On Red



Stop



Yield











Warning

Depending on the specifications of the vehicle, signs may be displayed overlapping.











# TOYOTA SAFETY SENSE™

## SYSTEM ON/OFF

- (1) Press “ ” switches and select “” from the Multi-Information Display (MID).
- (2) Press “ ” switches and select “ RSA” and then press “” to turn RSA On/Off.
- (3) Press “” to go back to the menu.

**Note: If the vehicle was last turned off while a speed limit sign was displayed on the Multi-Information Display (MID), the same sign displays again when the vehicle is turned back ON.**

## ADDITIONAL RSA SETTINGS

- (1) Press “ ” switches and select “” from the Multi-Information Display (MID).
- (2) Press “ ” switches and select “ RSA” and then press and hold “”. The setting screen is displayed.
- (3) Press “ ” switches to select an RSA setting from the menu, and press “” to select or change a desired setting.
- (4) Press “” to go back to the menu.







*Refer to the Toyota “Owner’s Manual” for additional information on RSA operation, settings adjustments, limitations, and precautions before attempting to use it.*











## Proactive Driving Assist (PDA)

When system operating conditions are met, using the vehicle's camera and radar, Proactive Driving Assist (PDA) provides gentle braking into curves or gentle braking and/or steering to help support driving tasks such as distance control between your vehicle and a preceding vehicle, pedestrian, bicyclist or motorcycle.

### SYSTEM OPERATION DISPLAY











Icon	Meaning
	<ul style="list-style-type: none"> <li>• White: Monitoring for detectable objects</li> <li>• Green: Detectable object crossing the road or detectable object on the side of the road assistance operating</li> </ul>
	A pedestrian has been detected as crossing the road or on the side of the road and brake or steering assistance is operating
	A vehicle has been detected on the side of the road and brake or steering operation assistance is being performed
	<ul style="list-style-type: none"> <li>• Steering operation assistance is being performed to prevent the vehicle from approaching too close to a detectable object on the side of the road</li> <li>• When the steering assist is operating</li> </ul>
	Preceding vehicle deceleration assistance is being performed
	Warning to maintain appropriate vehicle-to-vehicle distance
	Curve deceleration assistance is being performed

### TURNING PDA ON/OFF

- (1) Press “ ” switches and select “” from the Multi-Information Display (MID).
- (2) Press “ ” switches and select “ PDA” and then press “” to turn PDA On/Off.
- (3) Press “” to go back to the menu.

# TOYOTA SAFETY SENSE™











## ADJUSTING PDA SUPPORT TIMING

- (1) Press “ ” switches and select “” from the Multi-Information Display (MID).
- (2) Press “ ” switches and select “() PDA” and then press and hold “.
- The setting screen is displayed.
- (3) Press “ ” switches and select “Sensitivity” and then press “.
- the desired setting. Each time it is pressed, the timing options changes “Later”, “Default” or “Earlier.”
- (4) Press “” to go back to the menu.

## OBSTACLE ANTICIPATION ASSIST (OAA)

Obstacle Anticipation Assist (OAA) is designed to detect vehicles parked on the side of the road, or pedestrians or bicyclists on the side of the road or crossing the road, and depending on the circumstances, OAA may provide mild braking and/or steering assist to control distance between the detected object and the vehicle. This system operates at vehicle speeds of approximately 20-35 mph (30-60 km/h).











## TURNING OBSTACLE ANTICIPATION ASSIST (OAA) ON/OFF

- (1) Press “ ” switches and select “” from the Multi-Information Display (MID).
- (2) Press “ ” switches and select “() PDA” and then press and hold “.
- The setting screen is displayed.
- (3) Press “ ” switches and select “OAA” or “Obstacle Anticipation Assist” and then press “.
- to turn the system On/Off.
- (4) Press “” to go back to the menu.

## DECELERATION ASSIST (DA)

Deceleration Assist (DA) is designed to provide braking assist and gently reduce vehicle speed when the system detects preceding vehicles or certain upcoming curves in the road and the driver is not pressing on the accelerator or brake pedals. This feature operates at speeds above approximately 15 mph (20 km/h). DA does not provide steering support and will not bring the vehicle to a complete stop.











## TURNING DECELERATION ASSIST (DA) ON/OFF

- (1) Press “ ” switches and select “” from the Multi-Information Display (MID).
- (2) Press “ ” switches and select “() PDA” and then press and hold “.
- The setting screen is displayed.
- (3) Press “ ” switches and select “DA” or “Deceleration Assist” and then press “.
- to turn the system On/Off.
- (4) Press “” to go back to the menu.

## STEERING ASSIST (SA)

PDA Steering Assist (SA) is designed to detect the lines of the roadway and vary the assistance from the power steering to help the driver stay within the lane. Steering Assist does not actively steer the vehicle. This feature is designed to operate at vehicle speeds between 5-80 miles per hour and does not require DRCC to be engaged.

## TURNING STEERING ASSIST (SA) ON/OFF

- (1) Press “ ” switches and select “” from the Multi-Information Display (MID).
- (2) Press “ ” switches and select “ PDA” and then press and hold “.
- The setting screen is displayed.
- (3) Press “ ” switches and select “SA” or “Steering Assist” and then press “.
- (4) Press “.

*Refer to the Toyota “Owner’s Manual” for additional information on PDA operation, settings adjustments, limitations, and precautions before attempting to use it.*

# SAFETY & EMERGENCY FEATURES

## Seat belts

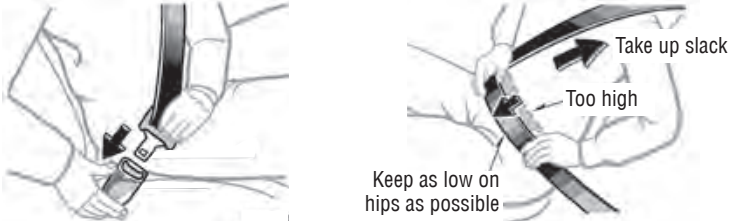

**NOTE:** If a passenger's seat belt is fully extended, then retracted even slightly, the Automatic Locking Retractor (ALR) will prevent it from being re-extended beyond that point, unless fully retracted again. This feature is used to help hold child restraint systems securely.

To find more information about seat belts, and how to install a child restraint system, refer to the "Owner's Manual".

## Seat belts - Shoulder belt anchor

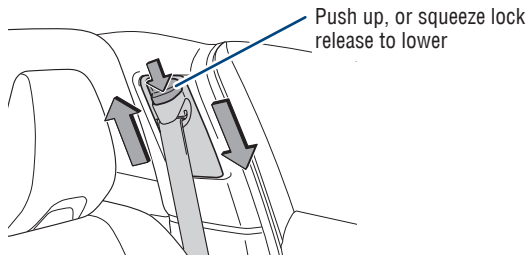

## Rear door child safety locks

Rear door

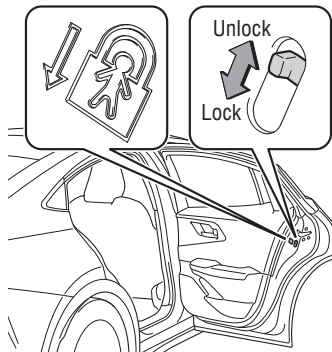

Moving the lever downward will allow the door to be opened only from the outside.

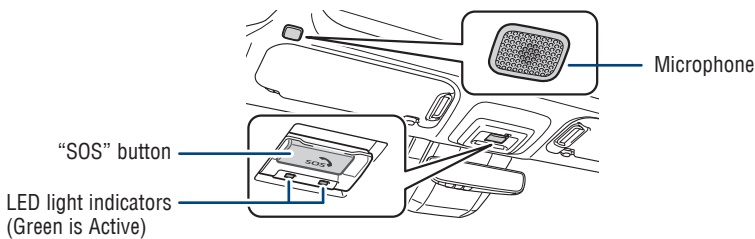

Safety Connect is a subscription-based telematics service that uses Global Positioning System (GPS) data and embedded cellular technology to provide safety and security features to subscribers. Safety Connect is staffed with live agents at the Toyota response center, which operates 24 hours per day, 7 days per week.

**Services for subscribers include:**

- Automatic collision notification
- Stolen vehicle locator
- Emergency assistance ("SOS" button)
- Enhanced roadside assistance

*For limitations and additional information, refer to the "Owner's Manual" or visit [www.toyota.com/connected-services](http://www.toyota.com/connected-services).*

# SAFETY & EMERGENCY FEATURES

## Spare tire & tools (if equipped)

### TOOL LOCATION

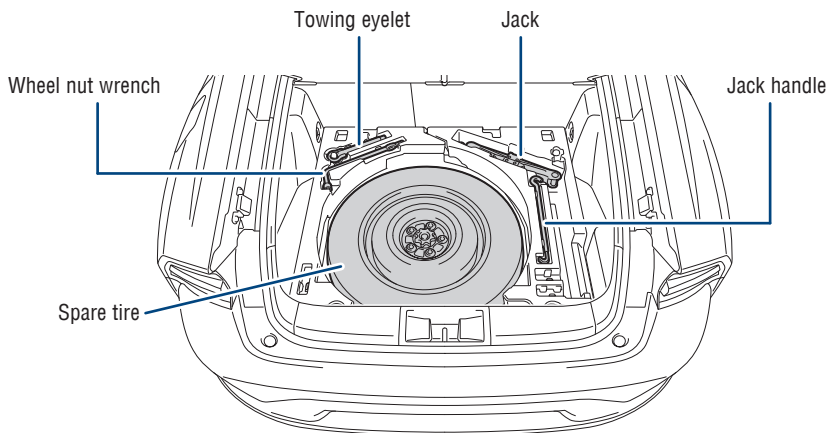

### REMOVING THE SPARE TIRE

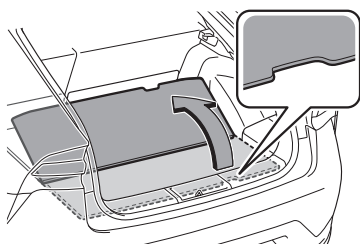

**(1)** Open the deck board.

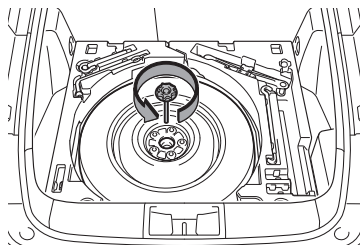

**(2)** Loosen the center fastener that secures the spare tire.

Refer to the "Owner's Manual" for tire changing and jack positioning procedures.

# Tire repair kit & tools (if equipped)

## TOOL LOCATION

### Deck under tray (type A)

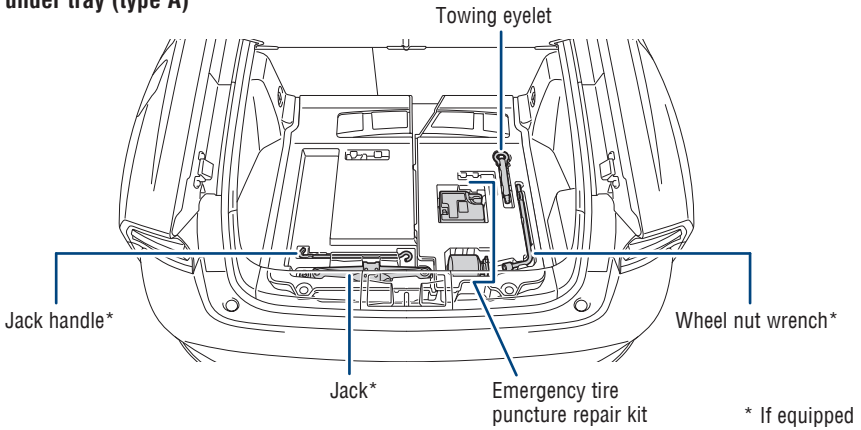

### Deck under tray (type B)

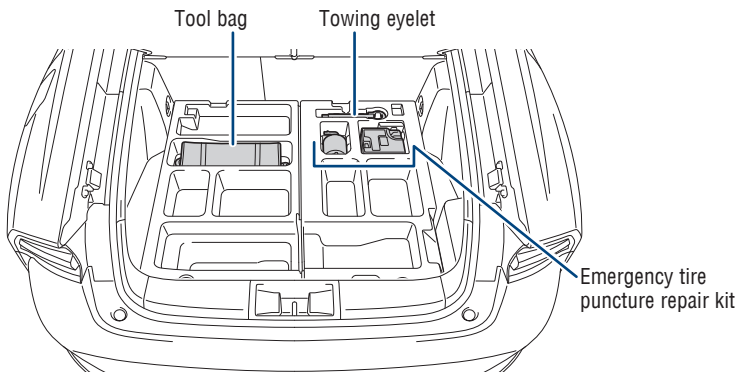

### Emergency tire puncture repair kit components

- Bottle -

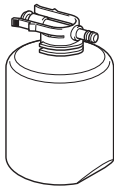

Sticker



- Compressor -

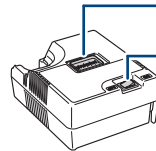

Air pressure gauge

Compressor switch

Power plug

Hose

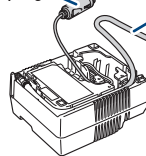

Air release cap





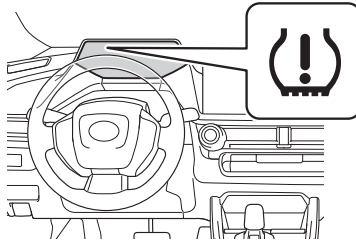

Refer to the "Owner's Manual" for more details.



## Tire Pressure Monitoring (warning) System (TPMS)



The tire pressure warning system can be selected on “” of the Multi-Information Display (MID).



### System reset initialization

- (1) Press “ ” switches and select “” from the Multi-Information Display (MID).
- (2) Press “ ” switches and select the “ Vehicle Settings” then press “.

(3) Press “ ” switches and select “TPWS setting” and then press “.

(4) Press “ ” switches and select “Tire Pressure Setting” and then press “.



- Setting by selecting a specified tire inflation pressure -

(5) Press “ ” switches and select “Setting by Specified Pressure” and then press “.

(6) Press “ ” switches and select the desired tire pressures, then press “.

The tire pressure warning light will slowly blink three times.

- Setting using the current tire inflation pressure -

(5) Press “ ” switches and select “Setting by Current Pressure” and then press “.

The tire pressure warning light will slowly blink three times and a message indicating that tire pressure is being set will be displayed on the MID.

The tire pressure detected by the tire pressure warning system can be displayed on the Multi-Information Display (MID).

If the tire pressure indicator flashes for 1 minute and then remains on, take the vehicle to your local Toyota dealer.

*Refer to the load label on the door jamb or the “Owner’s Manual” for tire inflation specifications.*

**NOTE: The warning light may come on due to temperature changes or changes in tire pressure from natural air leakage. If the system has not been initialized recently, setting the tire pressures to factory specifications should turn off the light.**



## Star Safety System™

Your vehicle comes standard with the Star Safety System™, which combines Anti-lock Braking System (ABS), Brake Assist (BA), Electronic Brake-force Distribution (EBD), Smart Stop Technology (SST), Traction Control (TRAC) and Vehicle Stability Control (VSC).

Refer to the “Owner’s Manual” for more details and important information on limitations to these systems.

### ANTI-LOCK BRAKE SYSTEM (ABS)

Toyota’s Anti-lock Brake System detects which wheels are locking up and limits wheel lockup by “pulsing” each wheel’s brakes independently. Pulsing releases brake pressure repeatedly for fractions of a second. This helps the tires attain the traction that current road conditions will allow, helping you to stay in directional control.

### BRAKE ASSIST (BA)

Brake Assist is designed to detect sudden or “panic” braking, and then add braking pressure to help decrease the vehicle’s stopping distance. When there’s only a split second to react, Brake Assist can add additional brake pressure more quickly than just the driver alone can.

### ELECTRONIC BRAKE FORCE DISTRIBUTION (EBD)

Toyota’s ABS technology has Electronic Brake-force Distribution (EBD) to help maintain control and balance when braking. EBD responds to sudden stops by redistributing brake force to enhance the braking effectiveness of all four wheels.

### SMART STOP TECHNOLOGY (SST)

Smart Stop Technology automatically reduces engine power when the accelerator and brake pedals are pressed simultaneously under certain conditions.

SST engages when the accelerator is depressed first and the brakes are applied firmly for longer than one-half second at speeds greater than five miles per hour.

SST doesn’t engage if the brake pedal is depressed before the accelerator pedal, allowing vehicles to start on a steep hill and safely accelerate without rolling backward.

### ENHANCED VEHICLE STABILITY CONTROL (VSC)

Enhanced Vehicle Stability Control provides cooperative control of the ABS, TRAC, VSC and EPS.

Enhanced VSC helps to maintain directional stability when loss of traction occurs during a turn.

# SAFETY & EMERGENCY FEATURES

## TRACTION CONTROL (TRAC)

VSC helps prevent loss of traction during cornering by reducing Hybrid System output, and Traction Control helps maintain traction on loose gravel and wet, icy, or uneven surfaces by applying brake force to the spinning wheel(s).

Toyota's TRAC sensors are activated when one of the drive wheels starts to slip. TRAC limits Hybrid System output and applies the brakes to the spinning wheel. This transfers power to the wheels that still have traction to help keep you on track.

## Floor mat installation

There are two types of Toyota floor mats: carpeted and all-weather. Each vehicle has model-specific floor mats. Installation is easy.

To keep your floor mat properly positioned, follow these steps:

- Only use Toyota floor mats designed for your specific model.
- Only use one floor mat at a time, using the equipped fasteners to keep the mat in place.
- Install floor mats right side up.

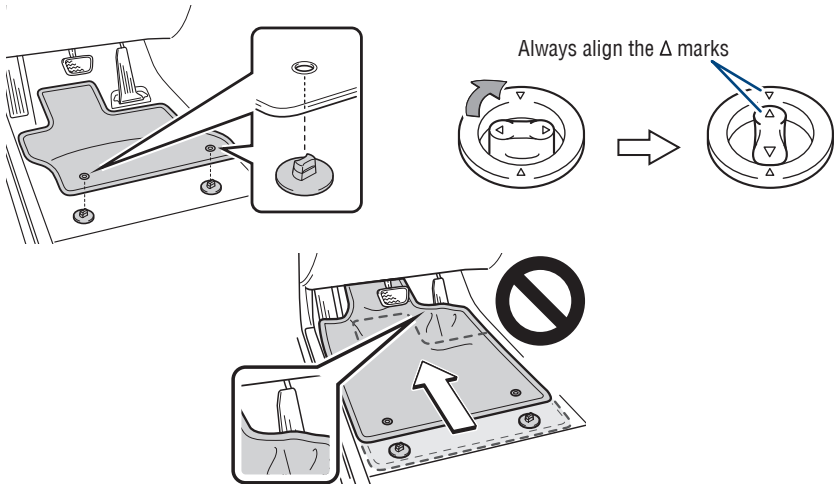



# GETTING STARTED WITH TOYOTA AUDIO MULTIMEDIA AND CONNECTED SERVICES

- Registering Your Vehicle
- Toyota app
- Bluetooth® Pairing
- Connected Services
- Apple CarPlay®
- Android Auto™
- SiriusXM®
- Online Support Tool
- Updating System Software

Scan QR Code to Download Toyota app

Apple



Android



Do not attempt the process while driving.

# Registering Your Vehicle

With the Toyota app, you will be connected to your Toyota on the go. Use the app to personalize your profile and take the customized vehicle settings and preferences for the multimedia features you enjoy most with you too. Get real time vehicle health information, enjoy remote service, manage your Connected Services subscriptions and more.



**STEP 1** Start the vehicle and select your language preference.

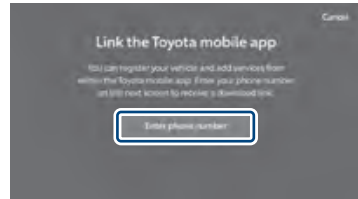

**STEP 2** Select “Enter phone number”.



**STEP 3** Enter your mobile phone number to receive a link to download the Toyota app.

**STEP 4** Download and open the Toyota app on your device and follow instructions to add your vehicle by scanning the QR Code displayed on your vehicle's screen. Complete the steps in your Toyota app to create your profile, activate included trial services and enable access in your vehicle.

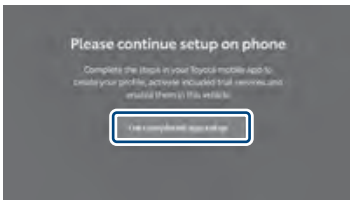

**STEP 5** Once complete, select “I’ve completed app setup”.



**STEP 6** A welcome banner will be displayed on screen to confirm linking is complete.

# GETTING STARTED WITH

## Toyota app



TOYOTA

Toyota app allows access to valuable information about your vehicle and control of capable features equipped with your vehicle.

- Manuals & Warranties
- Schedule Maintenance
- Roadside Assistance
- Vehicle Health Report
- SiriusXM® Radio
- Safety Recalls
- Toyota Financial Services - Vehicle Payment

Remote Connect equipped vehicle functions:

- Lock/Unlock
- Start Vehicle
- Vehicle Finder
- Guest Driver settings
- Hazard Lights On
- Horn Alert
- Buzzer Alert
- Lock/Unlock Hatch
- Remote Climate
- Digital Key (if equipped)

Scan QR Code to Download Toyota app.

Apple



Android



Or

Search "Toyota" at your applicable app store.



If you have a Toyota Owner's account, use your credentials to "Sign In" and get started with Toyota app.

Or

If you do not have a Toyota Owner's account, "Register" now to get started with Toyota app.



# Bluetooth® Pairing<sup>1</sup>

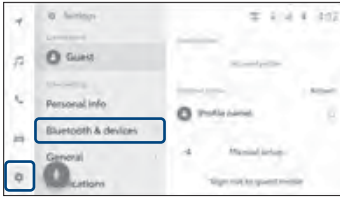

**Note:**  
Do not attempt the Bluetooth®  
Pairing process while driving.

**STEP 1** Select [GEAR ICON] from the main menu, then “Bluetooth & Devices.”



iPhone Bluetooth Menu



Android Bluetooth Menu

**STEP 2** Ensure Bluetooth is turned on for your phone.



**STEP 3** Select “Manage devices”, then “Search for devices.”



**STEP 4** Select “Device name” to register.

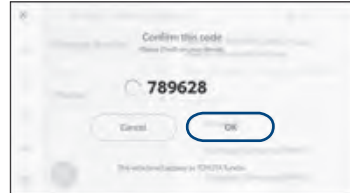

**STEP 5** Check that the displayed PIN code matches the PIN code displayed on the Bluetooth® device, and then select [OK].

## Bluetooth® Pairing<sup>1</sup> (continued)



**STEP 6** If your device supports Apple CarPlay / Android Auto, select “Yes” to enable.



**STEP 7** While pairing your device, a message may display asking to check your device to allow syncing contacts and allow messaging.

Note: You may also select “Skip” on display screen to skip enabling notifications. If skipped, proceed to **STEP 9**.



iPhone

Android

**STEP 8** Turn on “Show Notifications” for iPhone® or “ON” for Android.



**STEP 9** A confirmation will appear once your phone has been paired and connected.



## Connected Services<sup>2</sup>

Your vehicle may come available with a trial period for the following Connected Services.

Learn more at [www.toyota.com/connected-services/](http://www.toyota.com/connected-services/).

### Safety Connect<sup>3</sup>

- (SOS) EMERGENCY ASSISTANCE BUTTON
- AUTOMATIC COLLISION NOTIFICATION
- ROADSIDE ASSISTANCE
- STOLEN VEHICLE LOCATOR
- COLLISION ASSISTANCE

### Remote Connect<sup>4</sup> (if equipped)

- START VEHICLE
- VEHICLE STATUS ALERTS
- HAZARD LIGHTS ON
- BUZZER ALERT
- REMOTE CLIMATE
- LOCK/UNLOCK VEHICLE DOORS
- VEHICLE FINDER
- HORN ALERT
- LOCK/UNLOCK HATCH
- DIGITAL KEY (IF EQUIPPED)

Completing the registration process is required to enable Remote Connect.

### Service Connect<sup>5</sup> (if equipped)

- VEHICLE HEALTH REPORT
- VEHICLE MAINTENANCE ALERT NOTIFICATION

Completing the registration process is required to enable Service Connect.

### Drive Connect

- CLOUD NAVIGATION
- DESTINATION ASSIST
- INTELLIGENT ASSISTANT

## Connected Services<sup>2</sup> (continued)

### Wi-Fi Connect<sup>7</sup>

#### Multiple mobile devices

- Connect up to 5 Wi-Fi enabled devices
- Passengers can use smartphones, laptops and tablets

#### Infotainment

- Browse the internet
- Send and receive email
- Stay connected on social media
- Access favorite apps
- Stream movies



Several factors may affect smartphone and/or system performance including:

1. Smartphone operating system software version
2. Smartphone battery power level
3. Poor cellular reception to the smartphone
4. Multiple applications running on a smartphone at the same time
5. Charge/media cable quality
6. Smartphone operating system updates may also affect Toyota app functionality

For additional information, please visit: [www.toyota.com/connected-services](http://www.toyota.com/connected-services)

## Connected Services Online Support



Toyota's online support tool provides intuitive "How-To" instruction and videos.

To begin, please visit: <https://toyotaaudioandconnectedservicesupport.com/>

# Apple CarPlay® (Compatible iPhone® required)

## Setup of Apple CarPlay®



**STEP 1** Ensure Siri® is enabled on your phone.



**STEP 2** Plug a compatible iPhone® into the USB media port using an Apple® approved cable or have the smartphone and vehicle connected through Bluetooth®.

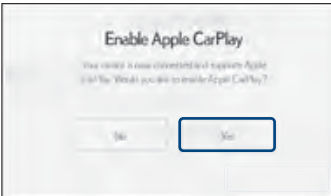

**STEP 3** On the multimedia system, select “Yes” when asked if you would like to Enable Apple CarPlay®.



**STEP 4** Select Allow to use CarPlay® while the phone is locked.



\* Screen depiction accurate at time of posting.

**STEP 5** To launch Apple CarPlay®, select the Apple CarPlay® icon on the top of the side menu bar.



\* Screen depiction accurate at time of posting.

**STEP 6** Apple CarPlay® is now ready to operate. You can go back to the Toyota multimedia system by using the Toyota icon in the Apple CarPlay® screen.

### Requirements:

Bluetooth® functions will be inoperable while CarPlay® is in use. Wireless CarPlay® is supported. Features may vary by vehicle model and phone.

To learn more about how your iPhone® works with CarPlay® visit: <https://support.apple.com/en-us/HT205634>

To view a full list of CarPlay® supported apps visit: <https://www.apple.com/ios/carplay/>

# GETTING STARTED WITH

## Apple CarPlay® (Compatible iPhone® required) (continued)

### Siri® through CarPlay®

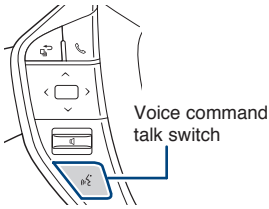

Press and hold the voice command talk switch for 2-3 seconds to activate.



\* Screen depiction accurate at time of posting.

Once Siri® is activated you can ask to: make calls, send and receive text messages, listen to music and more.

## Android Auto™ (Compatible Android™ device required)

### Setup of Android Auto™



**STEP 1** With Android 9 or below, the Android Auto™ app download is required. With Android 10, Android Auto™ is built in and the app is NOT required.



**STEP 2** Open Android Auto™ app and tap get started.



**STEP 3** Ensure Android Auto™ is enabled on the phone.



**STEP 4** Plug a compatible Android™ smartphone into the USB media port using an Android approved cable or have the smartphone and vehicle connected through Bluetooth®.

## Setup of Android Auto™ (continued)

**STEP 5** On the multimedia system, select “Yes” when asked if you would like to Enable Android Auto™.



**STEP 6** To launch Android Auto™, select the Android Auto™ icon on the top of the side menu bar.



\* Screen depiction accurate at time of posting.

**STEP 7** Android Auto™ is now ready to operate. You can go back to the Toyota multimedia system by using the Toyota icon in the Android Auto™ screen.

### Requirements:

Bluetooth® functions will be inoperable while Android Auto™ is in use. Wireless Android Auto™ is supported. Features may vary by vehicle model and phone.

To learn more about how to use Android Auto™ visit: <https://www.android.com/auto>

## Google Assistant through Android Auto™

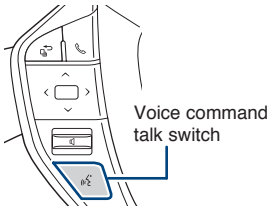

Press and hold the voice command talk switch for 2-3 seconds to activate.



\* Screen depiction accurate at time of posting.

Once Google Assistant is activated, you can ask to: make calls, send and receive text messages, listen to music and more.

## GETTING STARTED WITH

**SiriusXM® 8 (If equipped)**

### SiriusXM® Audio



\* Screen depiction accurate at time of posting.

Toyota vehicles equipped with SiriusXM® come with a 3-month Platinum Plan trial subscription. With the Platinum Plan, you get 350+ channels, including 165+ channels in your vehicle to enjoy ad-free music, plus sports, news, talk, comedy and more. Experience even more on the SXM App, featuring a collection of podcasts, Xtra channels of music, personalized Pandora® stations, SiriusXM video and more.



## Audio Multimedia Online Support



Toyota's online support tool provides intuitive "How-To" instruction and videos.

To begin, please visit: <https://toyotaaudioandconnectedservicesupport.com/>

## Updating System Software

The Toyota Audio Multimedia system is capable of over-the-air, over Wi-Fi®, and through USB flash drive updates. To use this function it is necessary to opt-in to the Connected Service Master Data Consent. When the Toyota Audio Multimedia system software is updated, the operating methods of functions may change. Each update will identify the proper updating method to one or all of the following methods:

- Update the software using the Data Communication Module (DCM)
- Update the software using Wi-Fi
- Update the software using a USB flash drive

See the Owner's Manual for complete details on the updating procedure.

After updating make sure to read the Digital Navigation Owner's Manual corresponding to the current software version available at <https://www.toyota.com/owners/resources/warranty-owners-manuals>.

---

## Privacy & Protection

To learn about Toyota's Connected Services data collection, use, sharing and retention, visit: [www.toyota.com/privacyvts](http://www.toyota.com/privacyvts).

- <sup>1</sup> The Bluetooth word mark and logos are registered trademarks owned by Bluetooth SIG, Inc. and any use of such marks by Toyota is under license. A compatible Bluetooth enabled phone must first be paired. Phone performance depends on software, coverage and carrier.
- <sup>2</sup> Visit [Toyota.com/connected-services](http://Toyota.com/connected-services) or see your local Toyota Dealer for additional details.
- <sup>3</sup> Safety Connect depends on an operative telematics device, a cellular connection, GPS signal strength and other factors outside of Toyota's control, all of which can limit system functionality or availability, including access to response center and emergency support. Stolen vehicle police report required to use Stolen Vehicle Locator. Some features may require the Toyota app. Registration required. Subscription required after trial. Service subject to change at any time without notice. Terms of Use apply. Data charges may apply. Service may vary by vehicle and region. See usage precautions and service limitations in Owner's Manual and [Toyota.com/connected-services/](http://Toyota.com/connected-services/) for additional details.  
To learn about Toyota's data collection, use, sharing and retention practices, please visit <https://www.toyota.com/privacyvts/>.
- <sup>4</sup> Toyota - Remote Connect  
Use only if aware of circumstances surrounding vehicle and it is legal and safe to do so (e.g., do not remotely start engine if vehicle is in an enclosed space or vehicle is occupied by a child). Toyota Remote Connect depends on an operative telematics device, a cellular connection, GPS signal strength and other factors outside of Toyota's control, which can limit system functionality and availability. Service may vary by vehicle and region. Registration and Toyota app download required. Subscription required after trial. Terms of Use apply. Data charges may apply. Remote start/stop not available on manual transmission-equipped vehicles. Services subject to change at any time without notice. See usage precautions and service limitations in Toyota Owner's Manual and <https://www.toyota.com/connected-services> for additional details.  
To learn about Toyota's data collection, use, sharing and retention practices, please visit <https://www.toyota.com/privacyvts/>.
- <sup>5</sup> Service Connect information provided is based on the last time data was collected from the vehicle and is not real time data. Service Connect depends on an operative telematics device, a cellular connection, GPS signal strength and other factors outside of Toyota's control, which can limit functionality or availability. Service may vary by vehicle and region. Registration required. Subscription required after trial. Service subject to change at any time without notice. Terms of Use apply. Data charges may apply. See usage precautions and service limitations in Owner's Manual and [Toyota.com/connected-services](http://Toyota.com/connected-services) for additional details.  
To learn about Toyota's data collection, use, sharing and retention practices, please visit <https://www.toyota.com/privacyvts/>.
- <sup>6</sup> Destination Assist depends on an operative telematics device, a cellular connection, navigation map data and GPS signal strength and other factors outside of Toyota's control, which can limit system ability functionality or availability. Use common sense when relying on this information. Service may vary by vehicle and region. Registration required. Subscription required after trial. Services subject to change at any time without notice. Terms of Use apply. Data charges may apply. See Owner's Manual and [Toyota.com/connected-services](http://Toyota.com/connected-services) for additional limitations and details.  
To learn about Toyota's data collection, use, sharing and retention practices, please visit <https://www.toyota.com/privacyvts/>.
- <sup>7</sup> Wi-Fi Connect is available on select 2018 and newer Toyota vehicles.  
Visit [Toyota.com/connectedservices](http://Toyota.com/connectedservices) for vehicle availability.
- <sup>8</sup> SiriusXM® audio services require a subscription sold separately by Sirius XM Radio Inc. To cancel, you must call SiriusXM at 1-866-635-2349. See SiriusXM Customer Agreement for complete terms at [www.siriusxm.com](http://www.siriusxm.com).  
All fees and programming subject to change. Not all vehicles or devices are capable of receiving all services offered by SiriusXM.



**TOYOTA**

**Quick Reference Guide 2023**



00505QRG23PRI



Printed in U.S.A. 11/22  
21-MKG-16282

[toyota.com](http://toyota.com)