

\* 1 : Shielded

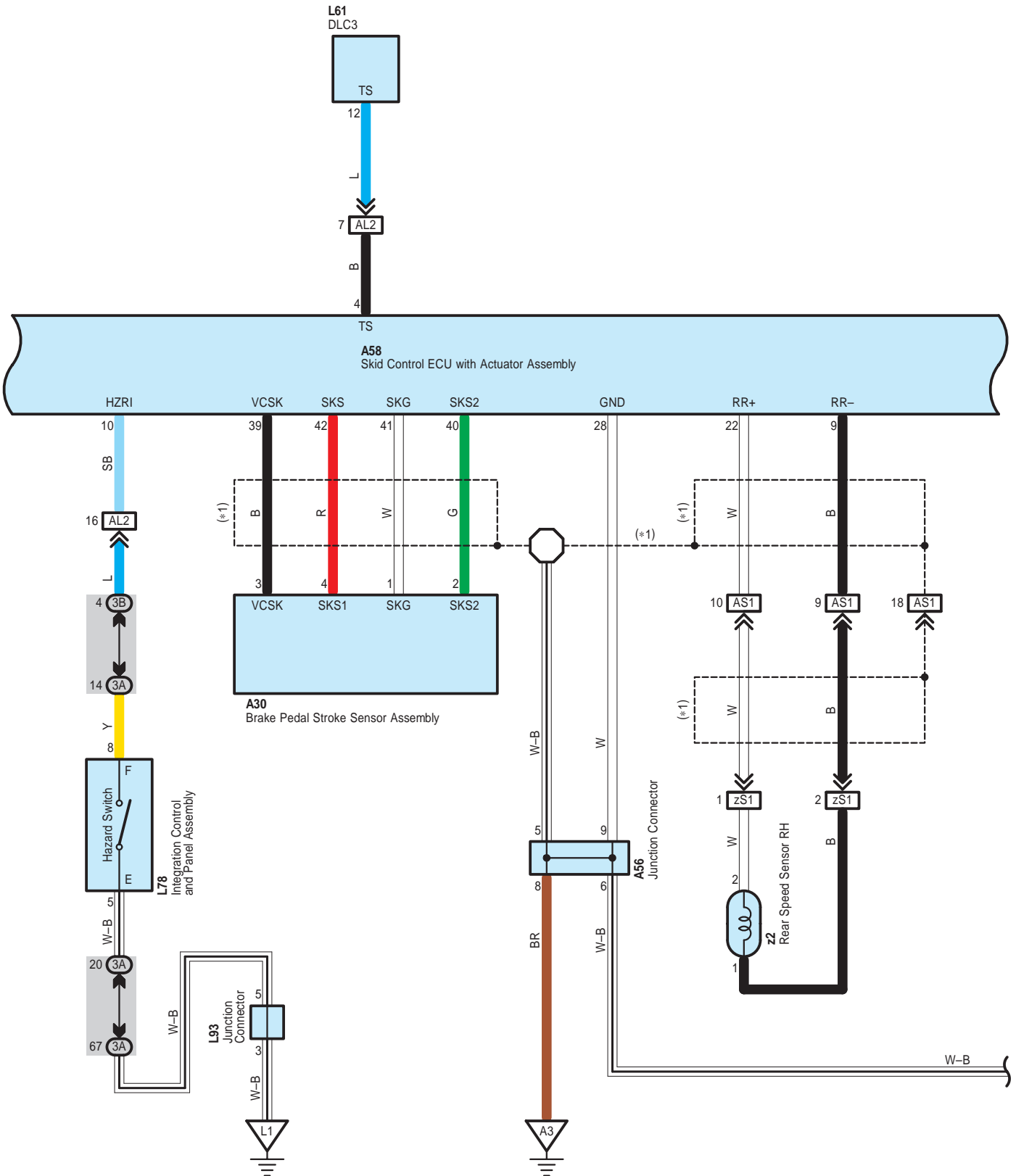

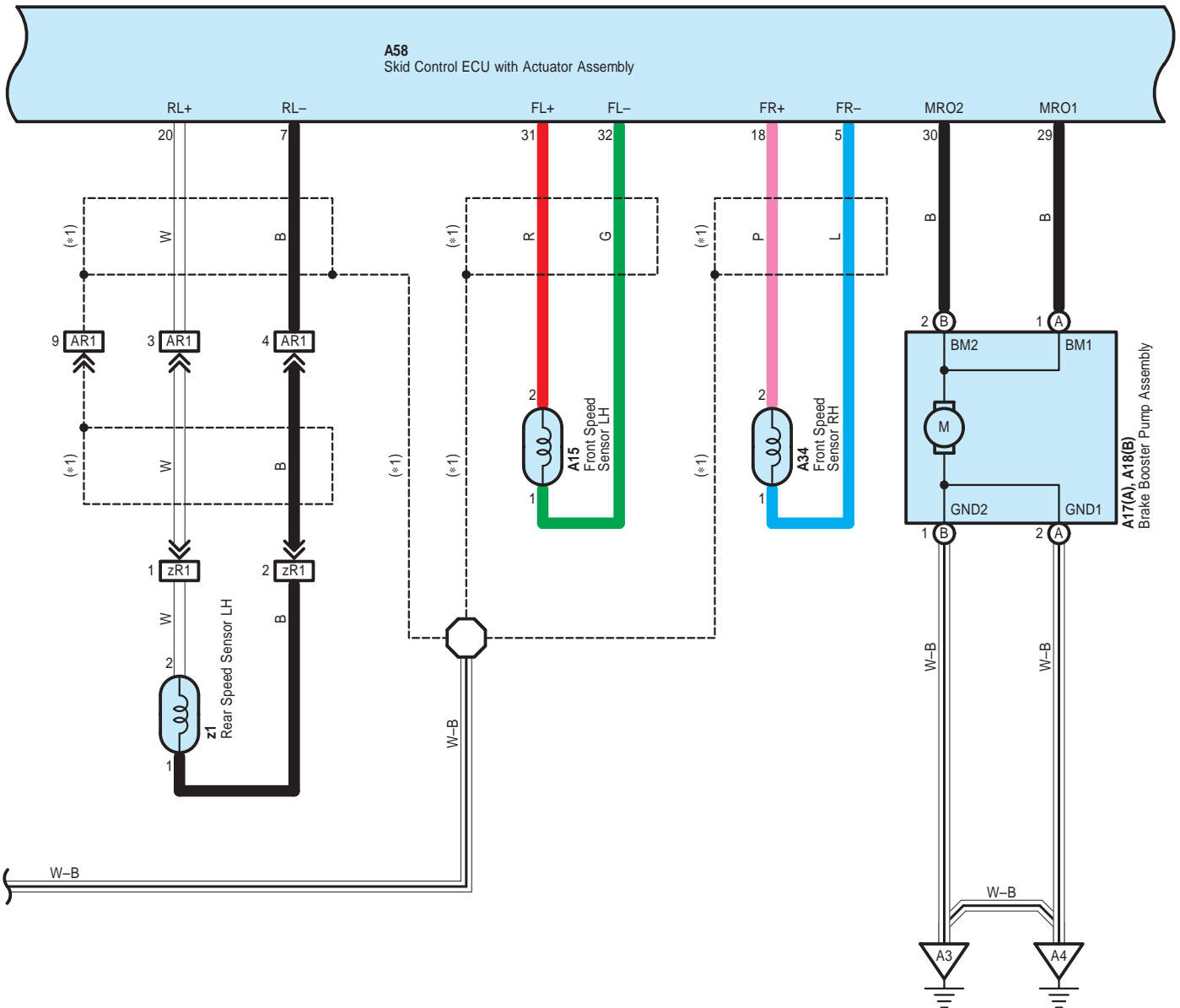

\* 1 : Shielded

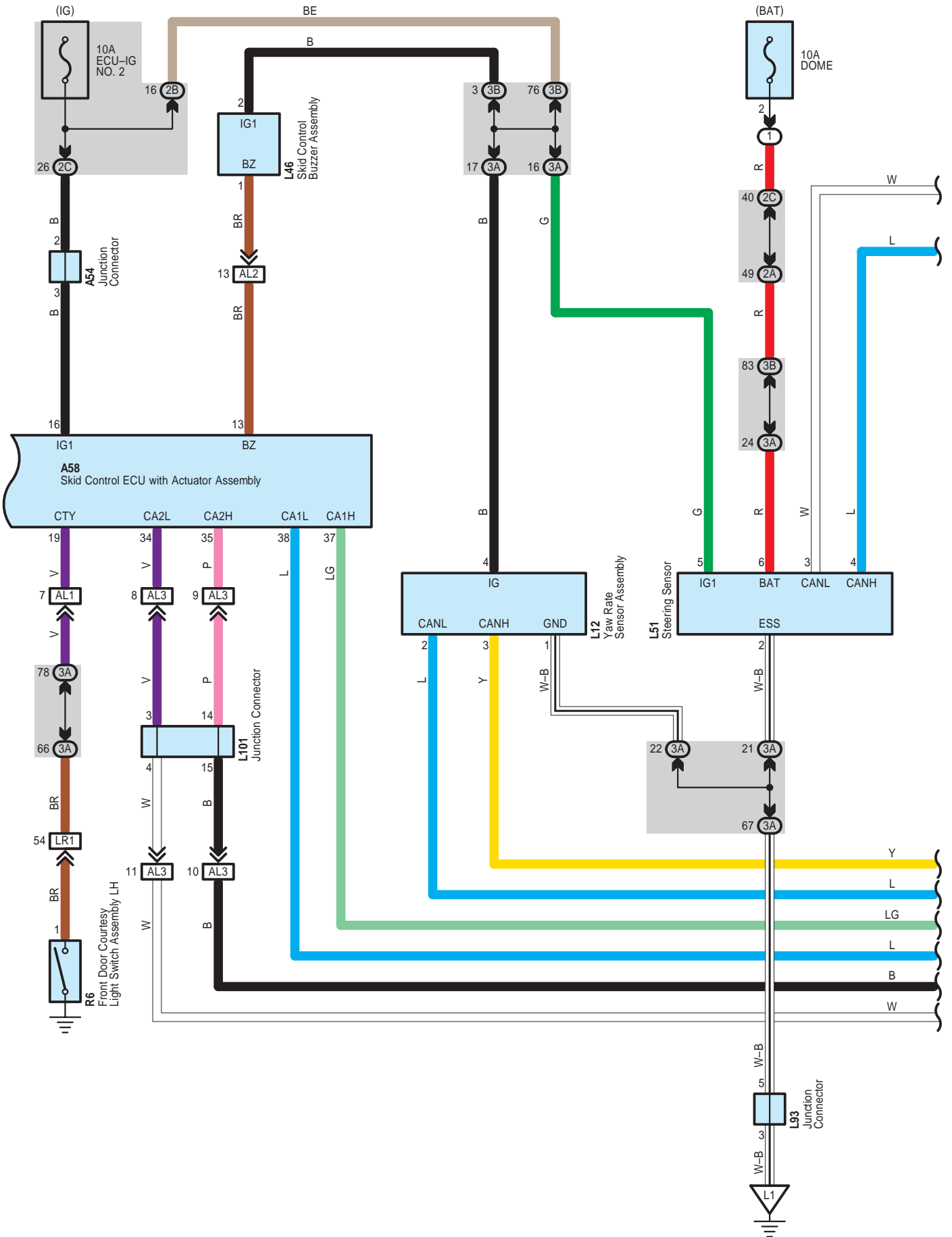

\* 1 : Shielded

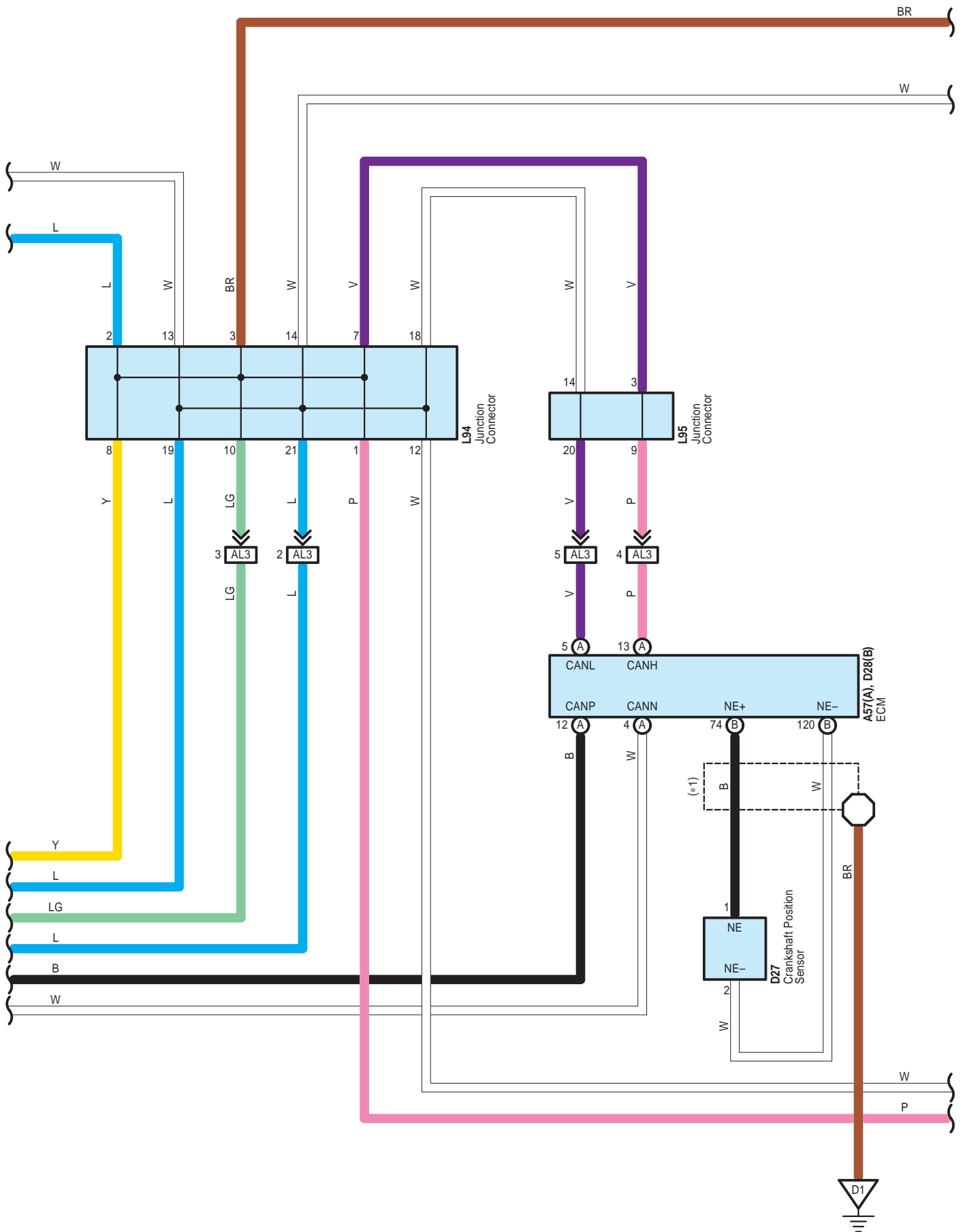

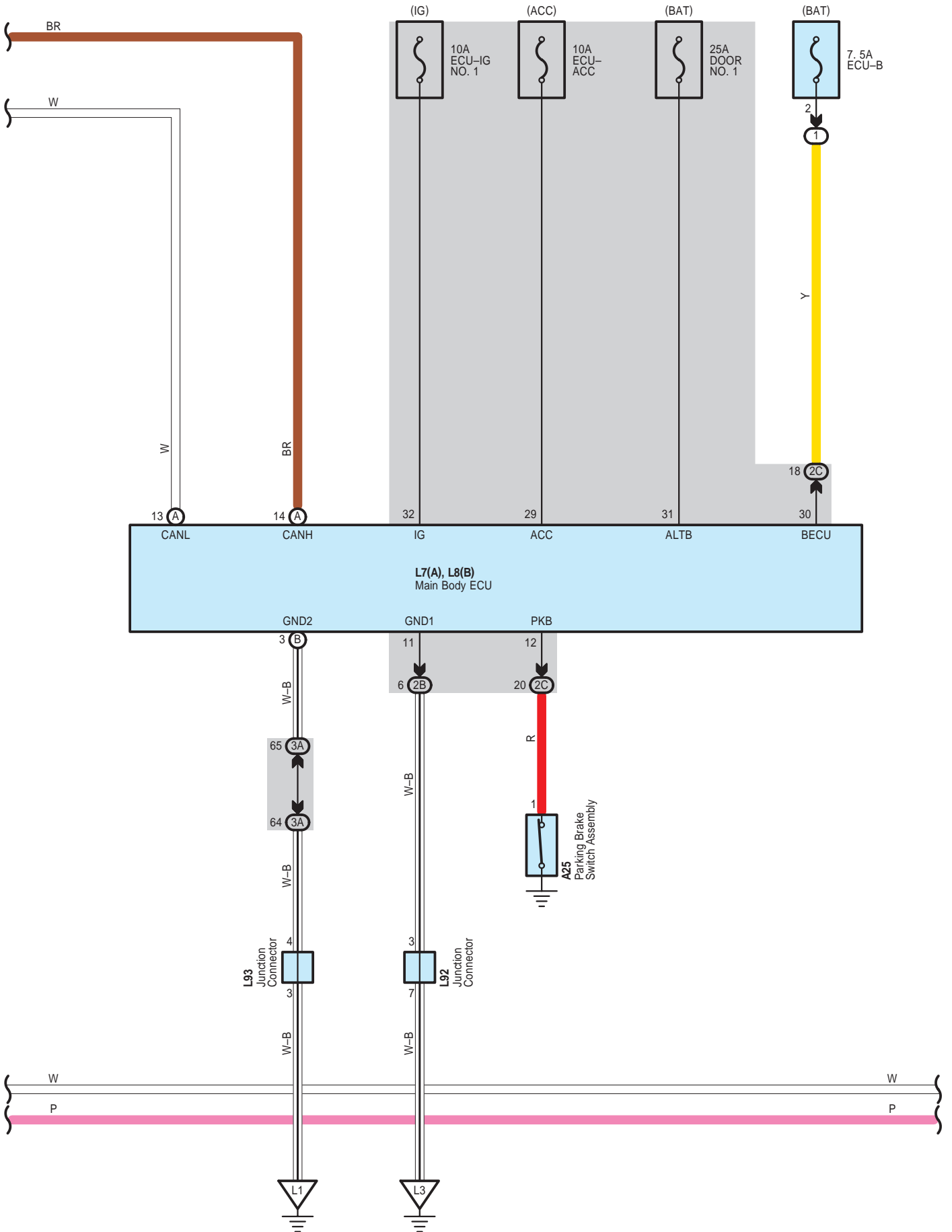

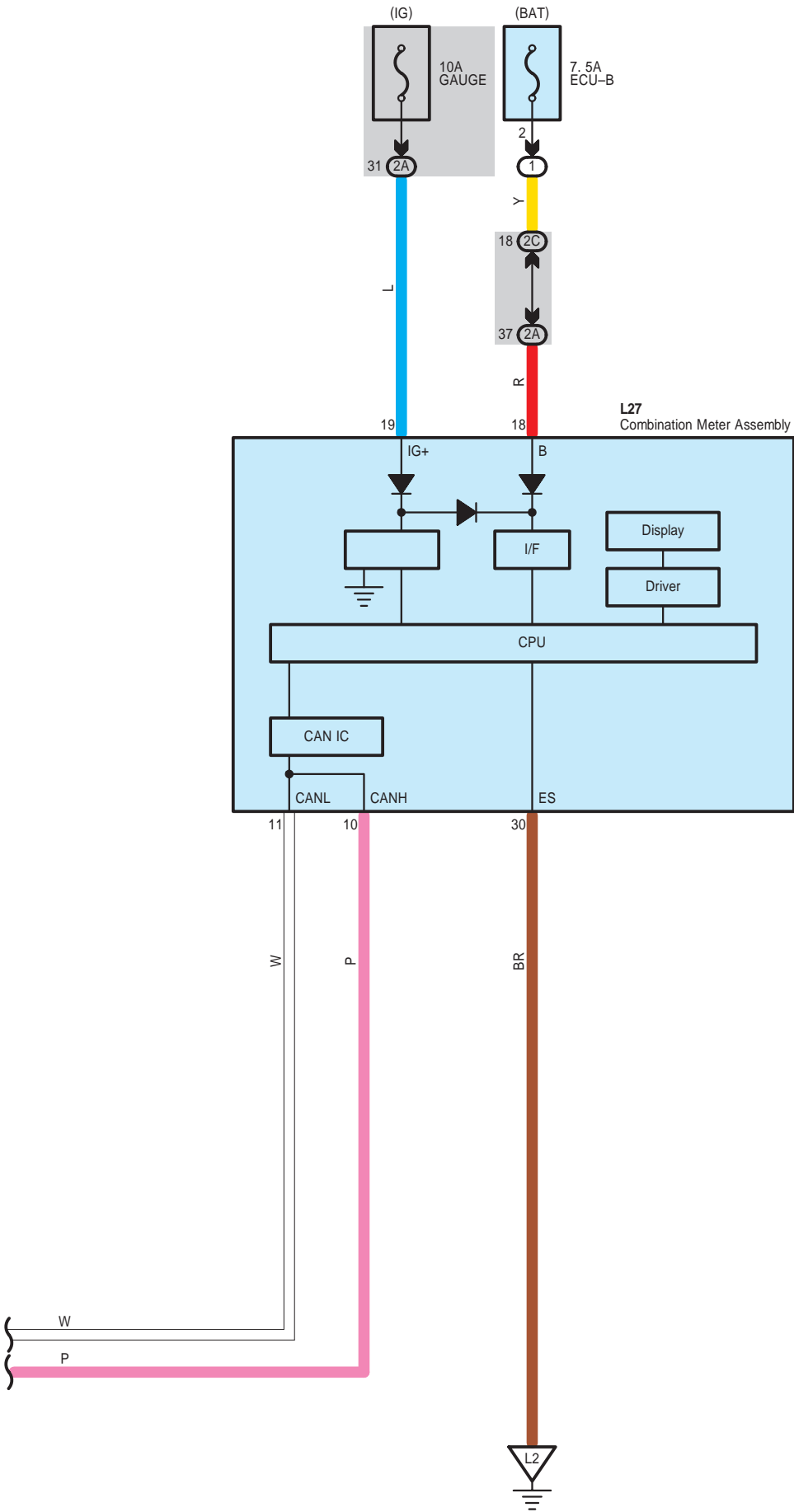

A 15

Black



A 17

Gray



A 18

Black

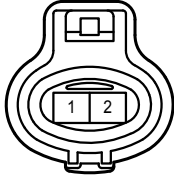

A 25

White



A 26

White

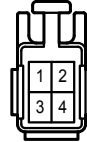

A 28

Black

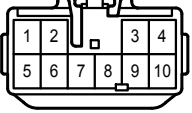

A 30

Black

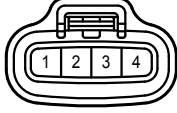

A 32

Black

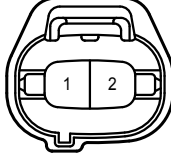

A 34

Black



A 50

White

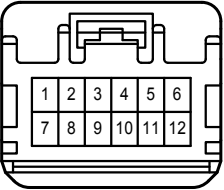

A 51

White

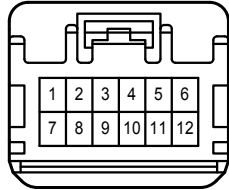

A 54

Black

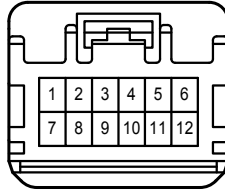

A 56

White

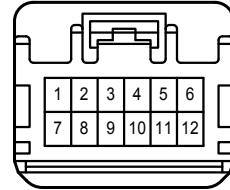

A 57

Black

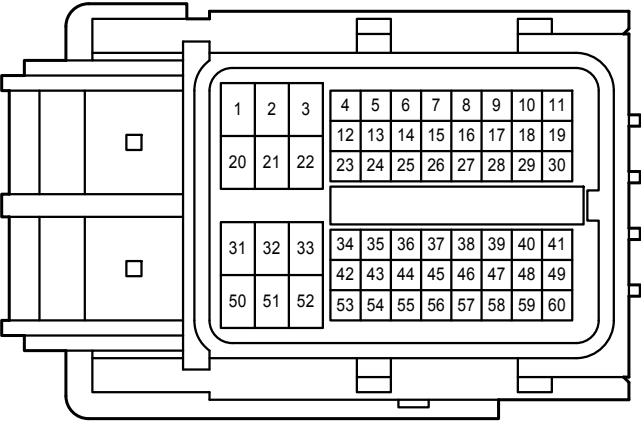

A 58

Gray

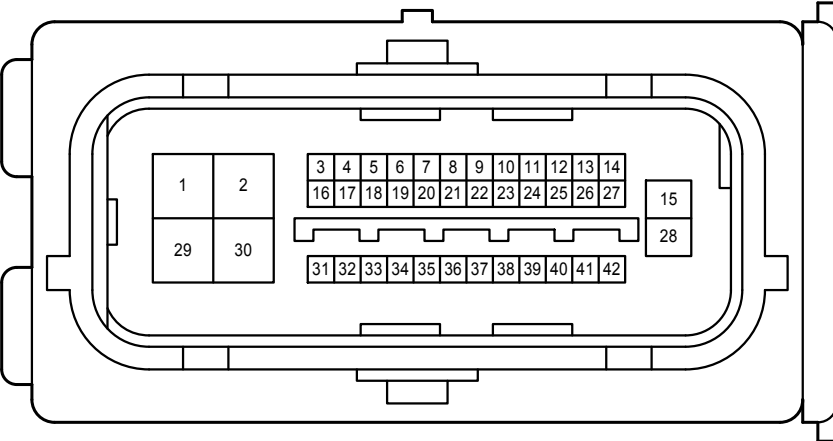

D 27

Black

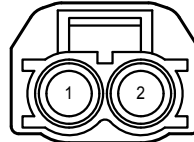



D 28  
Black

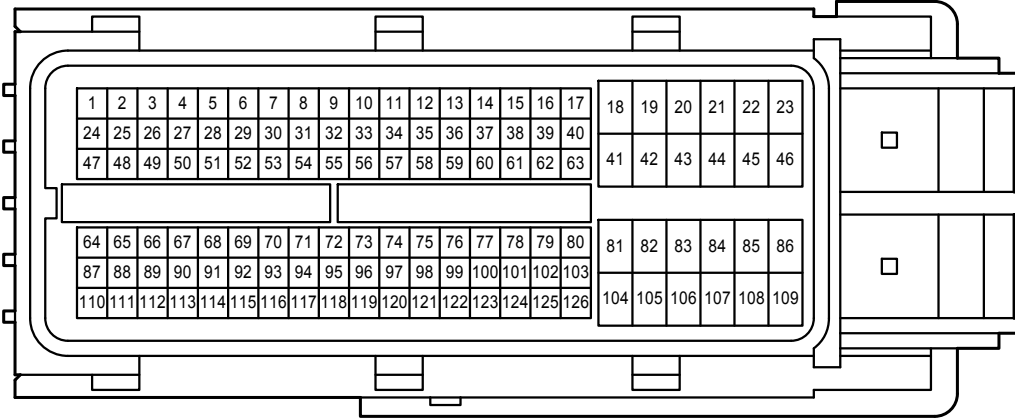

L 7  
White

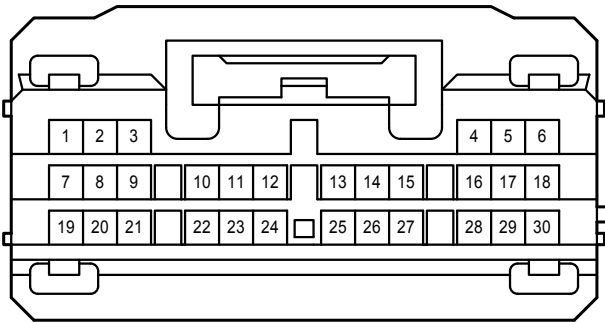

L 8  
White

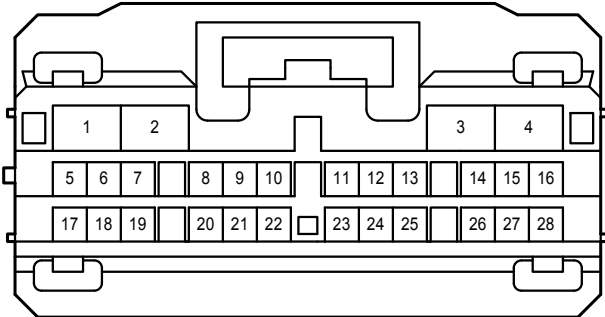

L 12  
Black

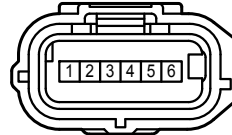

L 27  
White

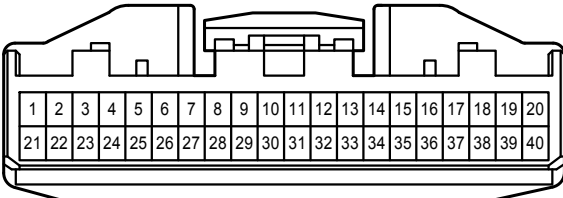

L 46  
Blue



L 51  
White

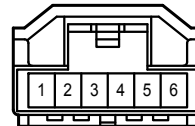

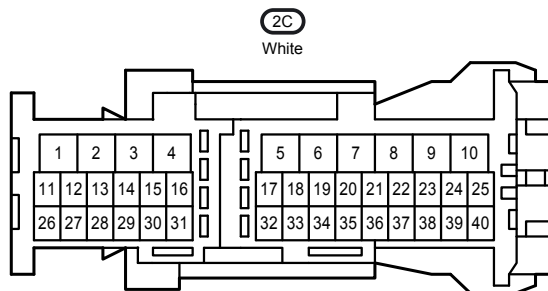
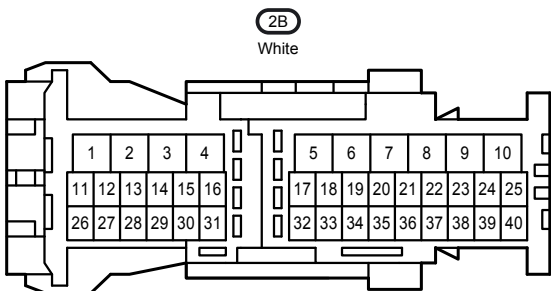
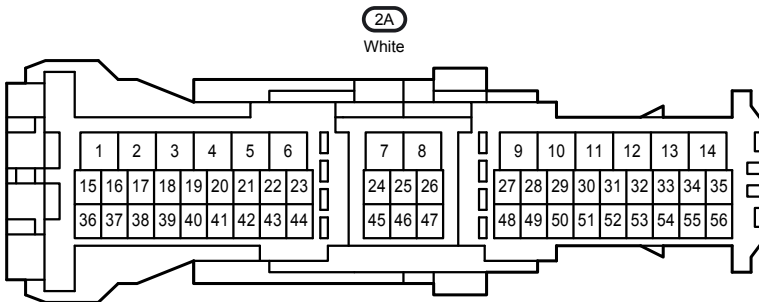
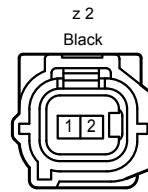
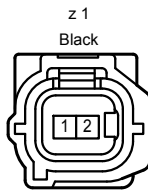
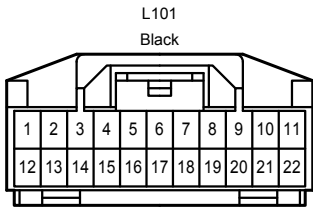
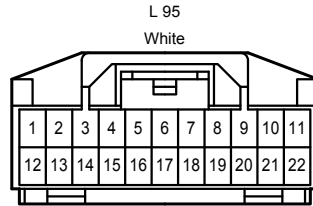
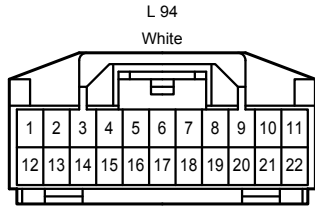
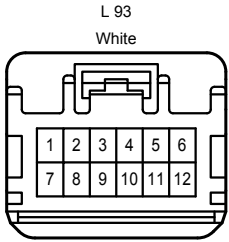
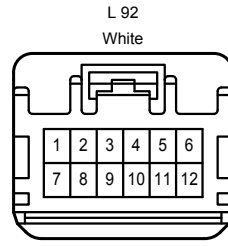
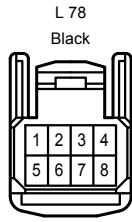
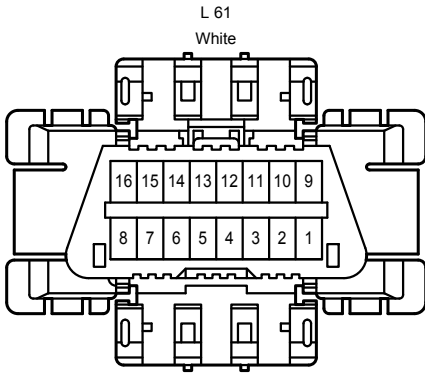

3A  
White

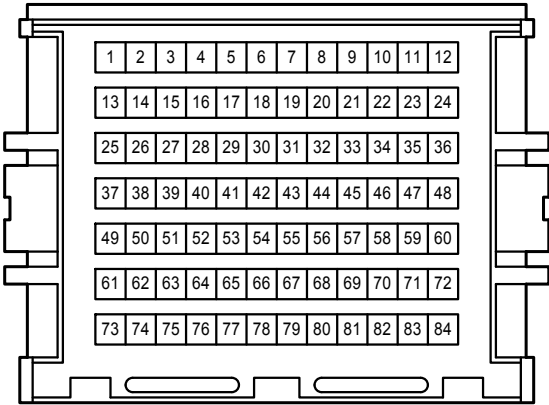

3B  
White

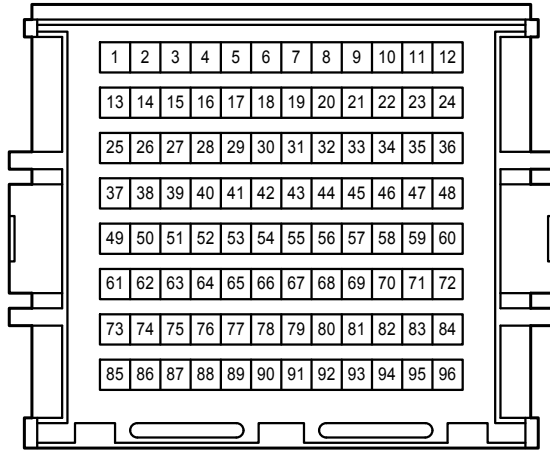

AL1  
Blue

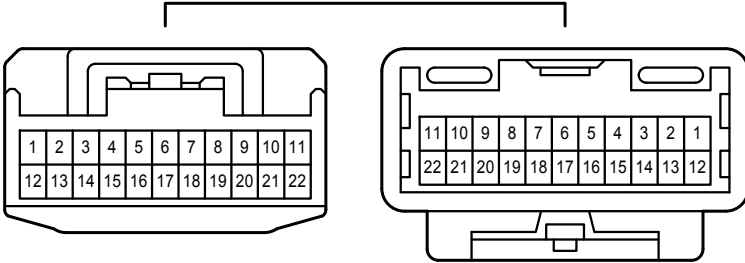

AL2  
Gray

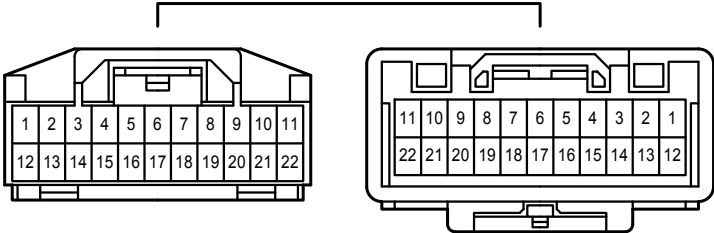

AL3  
White

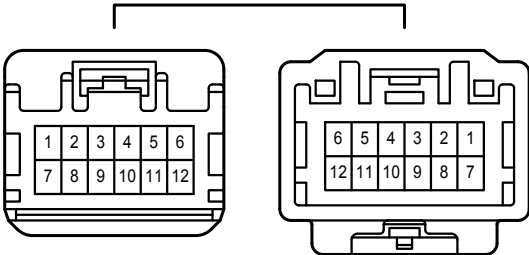

AR1  
White

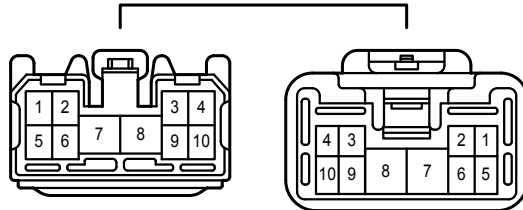

AS1  
White

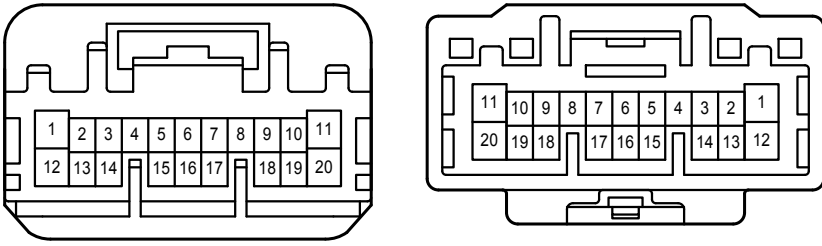

LR1  
White

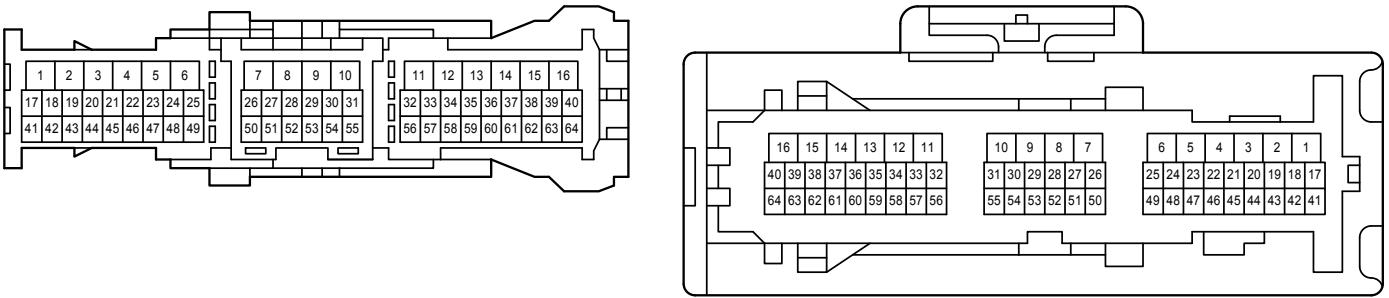

zR1  
White

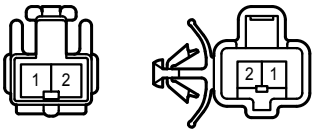

zS1  
White

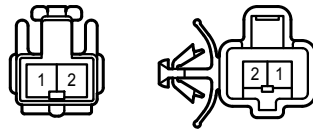

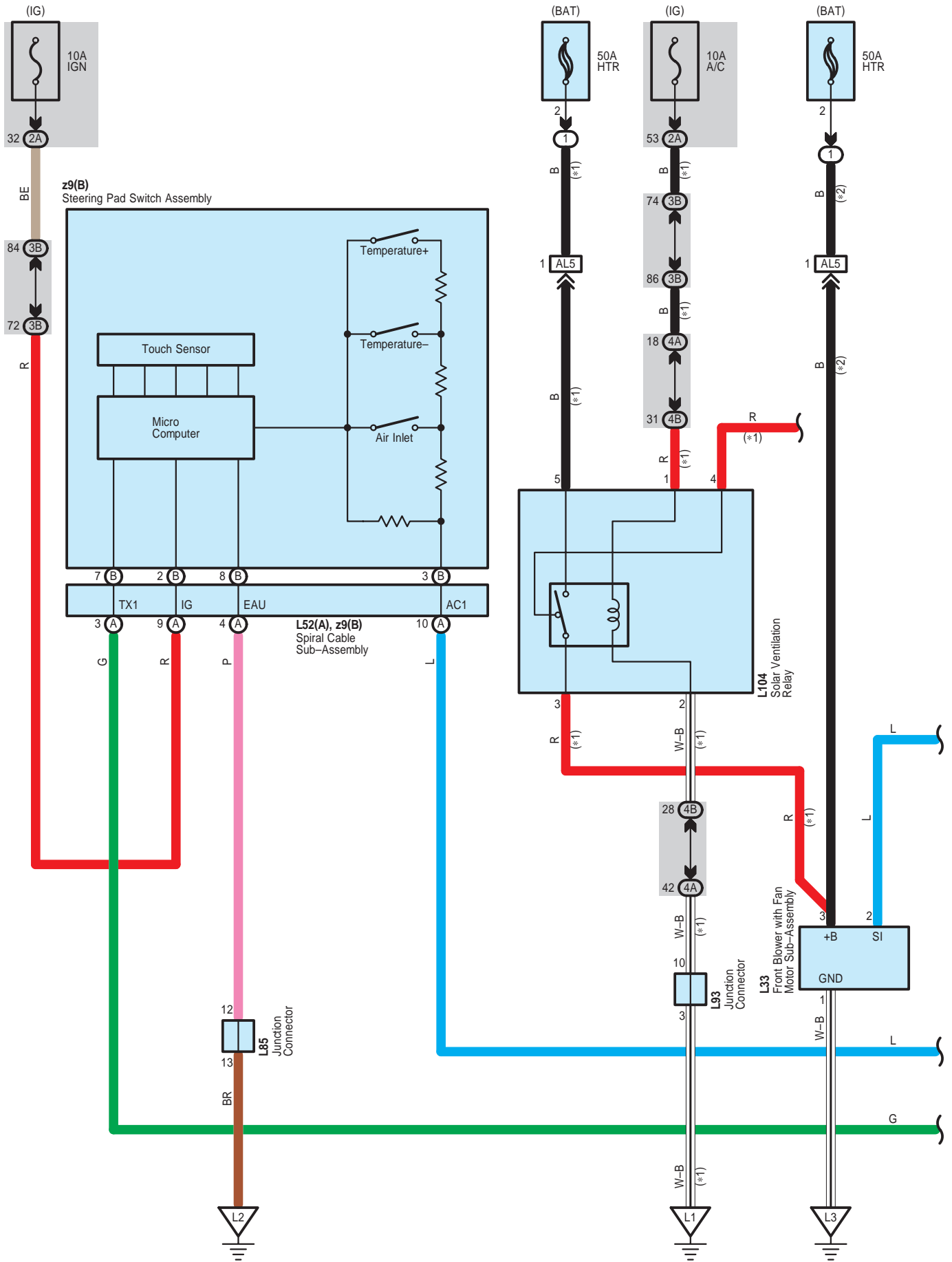

# Air Conditioning

- \* 1 : w/ Solar Ventilation System
- \* 2 : w/o Solar Ventilation System

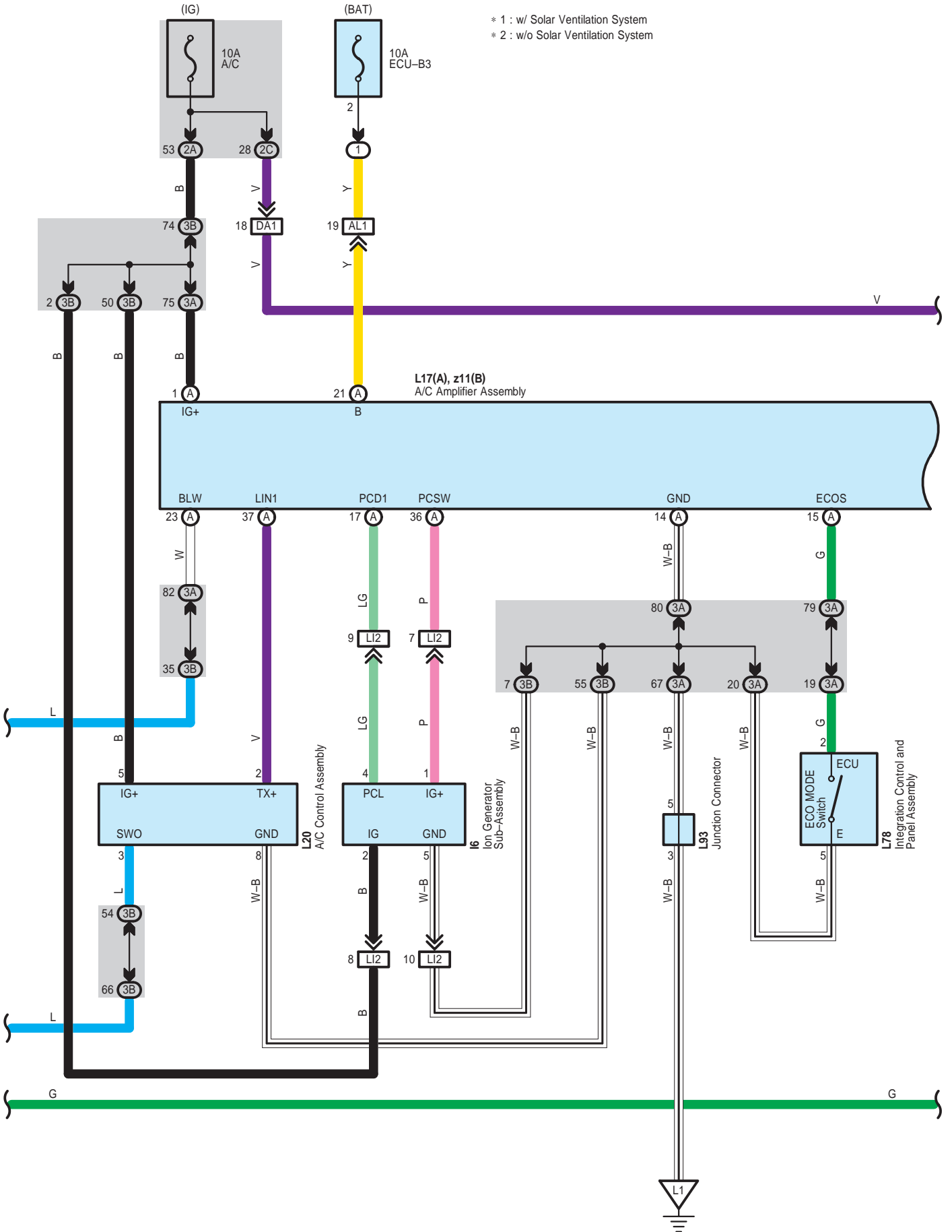

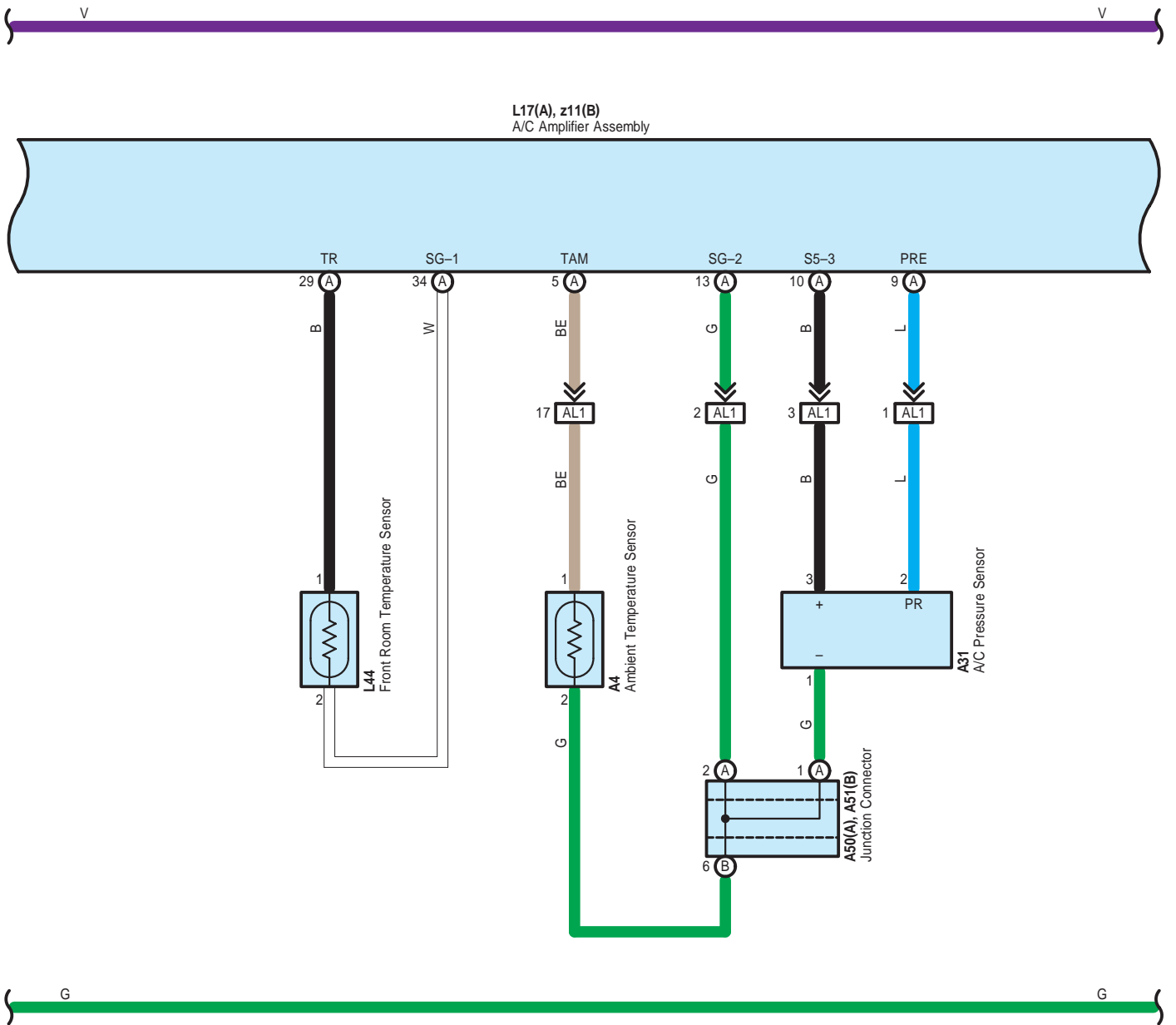

\* 3 : w/ PTC Heater

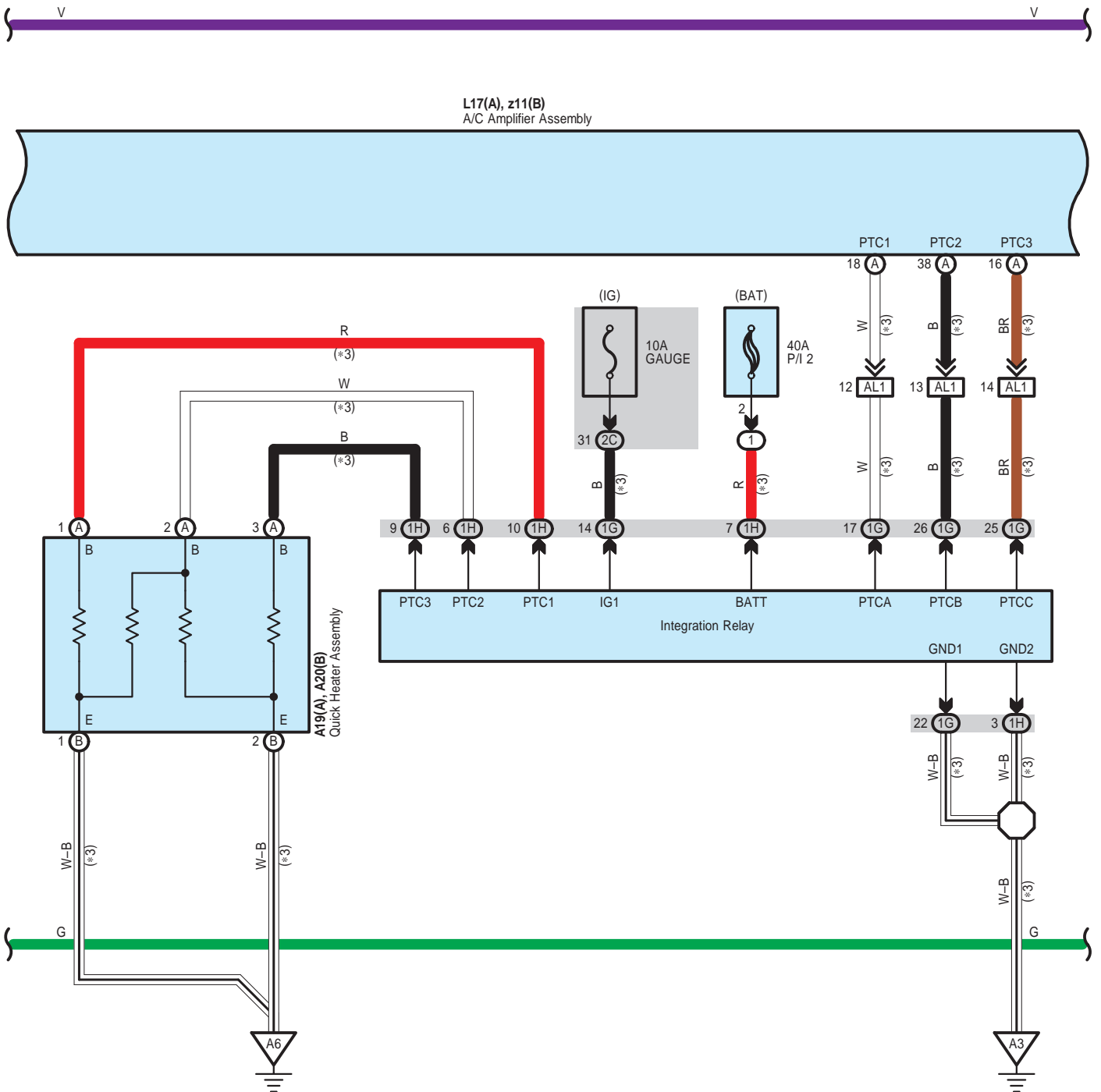





L17(A), z11(B)  
A/C Amplifier Assembly

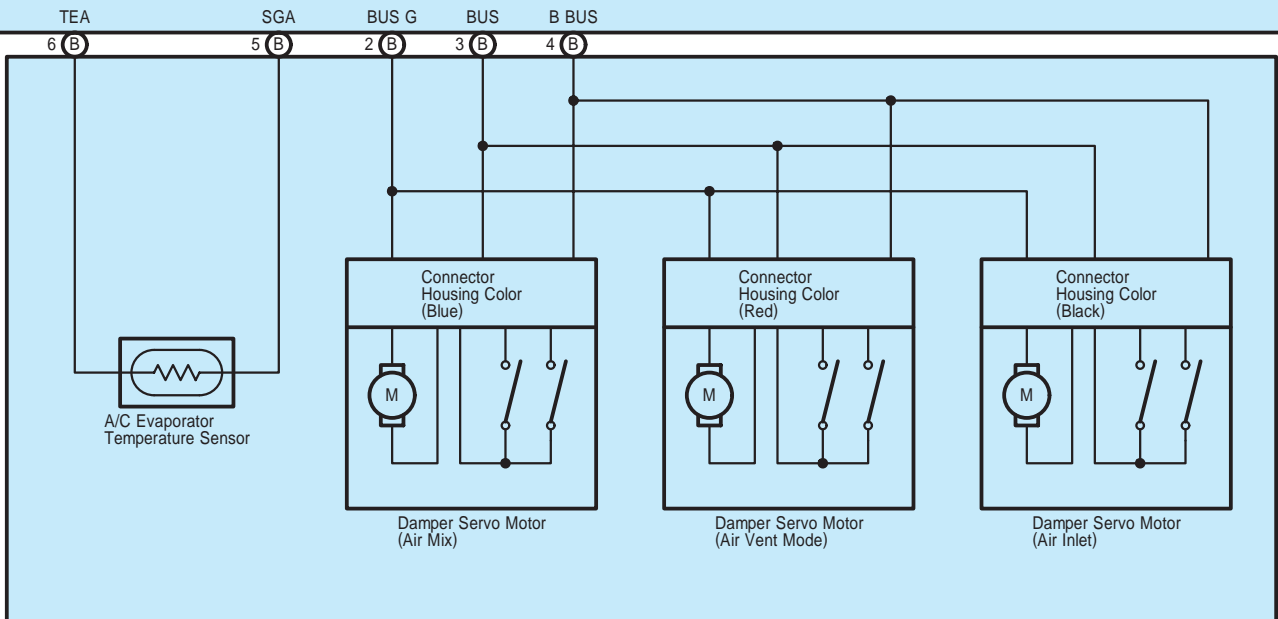
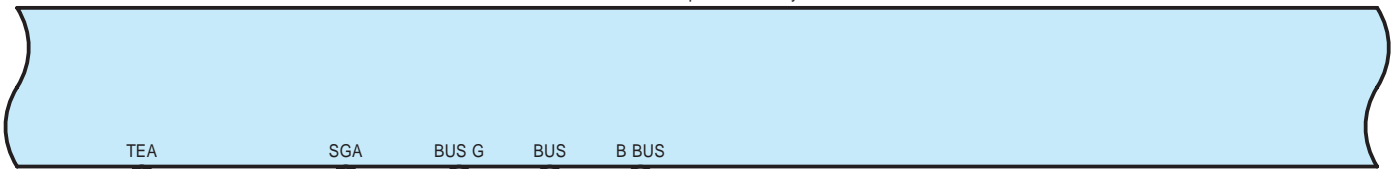

z11(B)  
A/C Blower Assembly



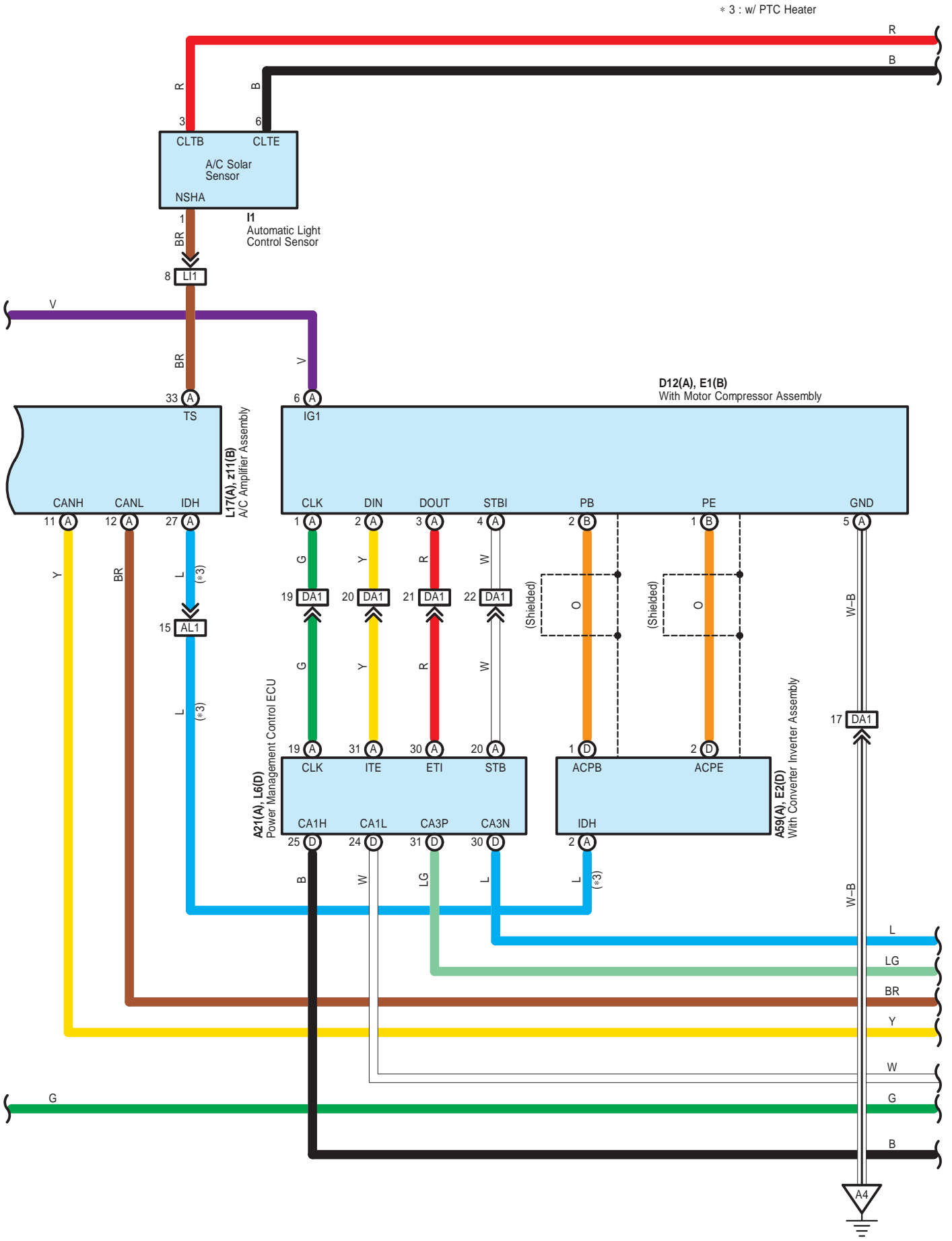

# Air Conditioning

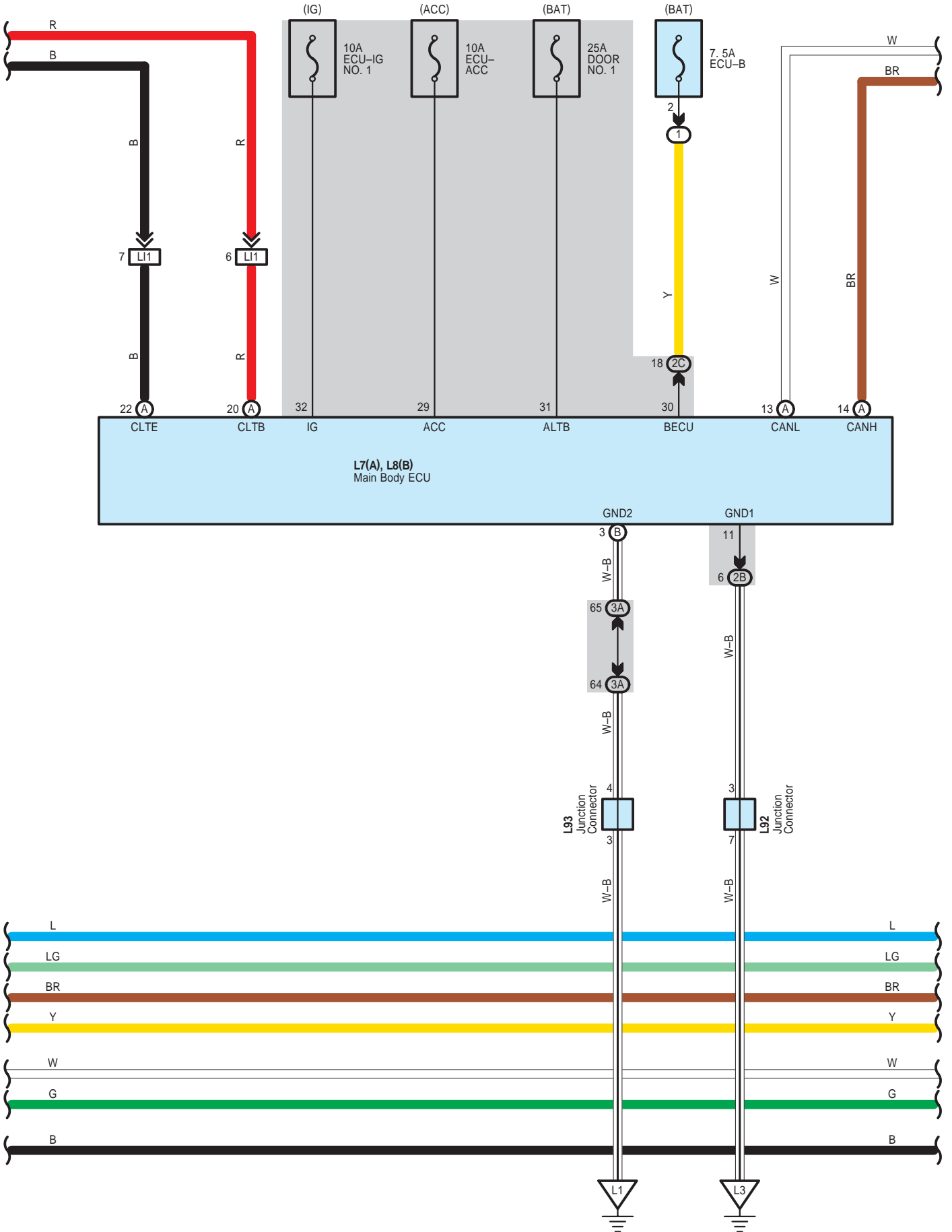

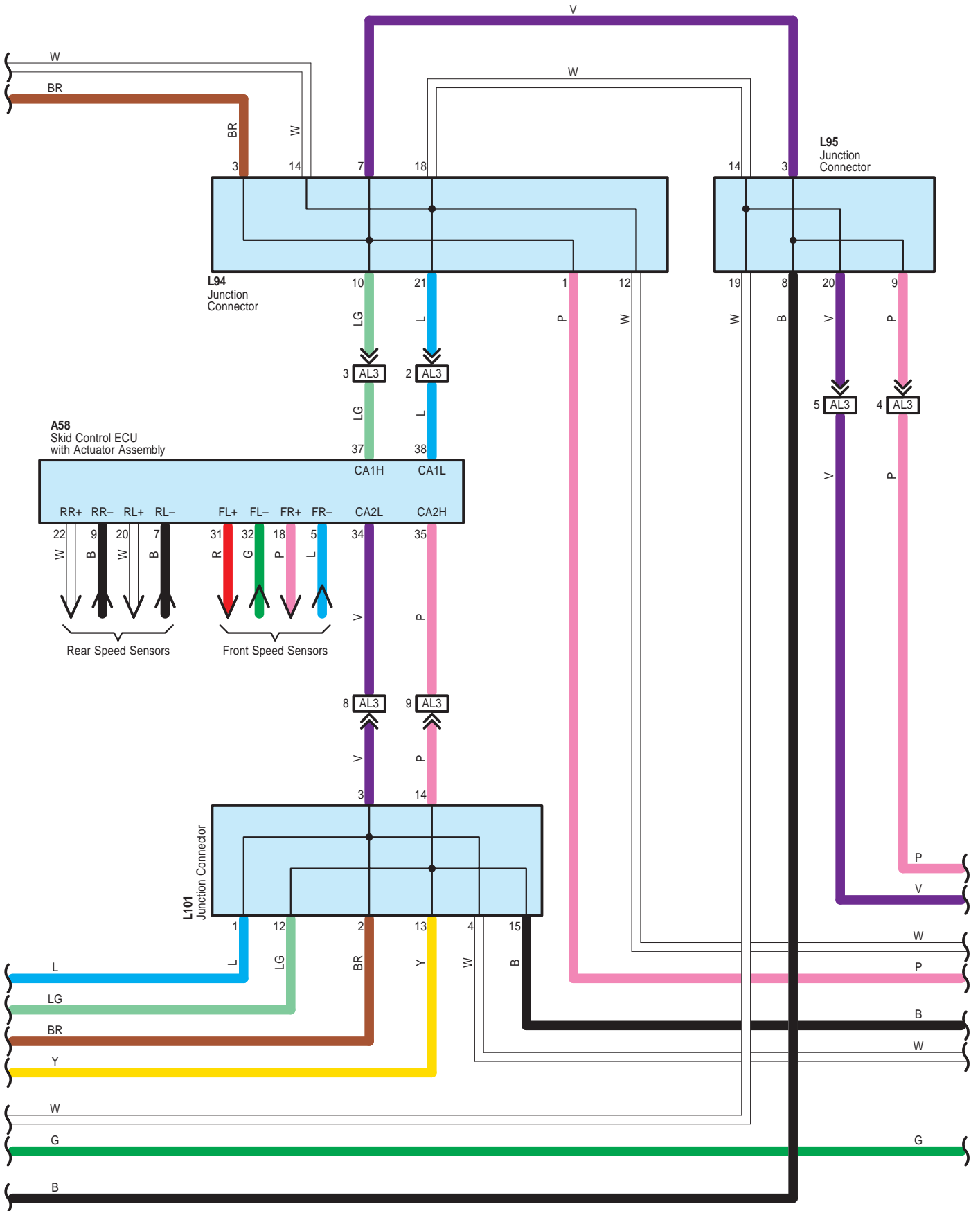

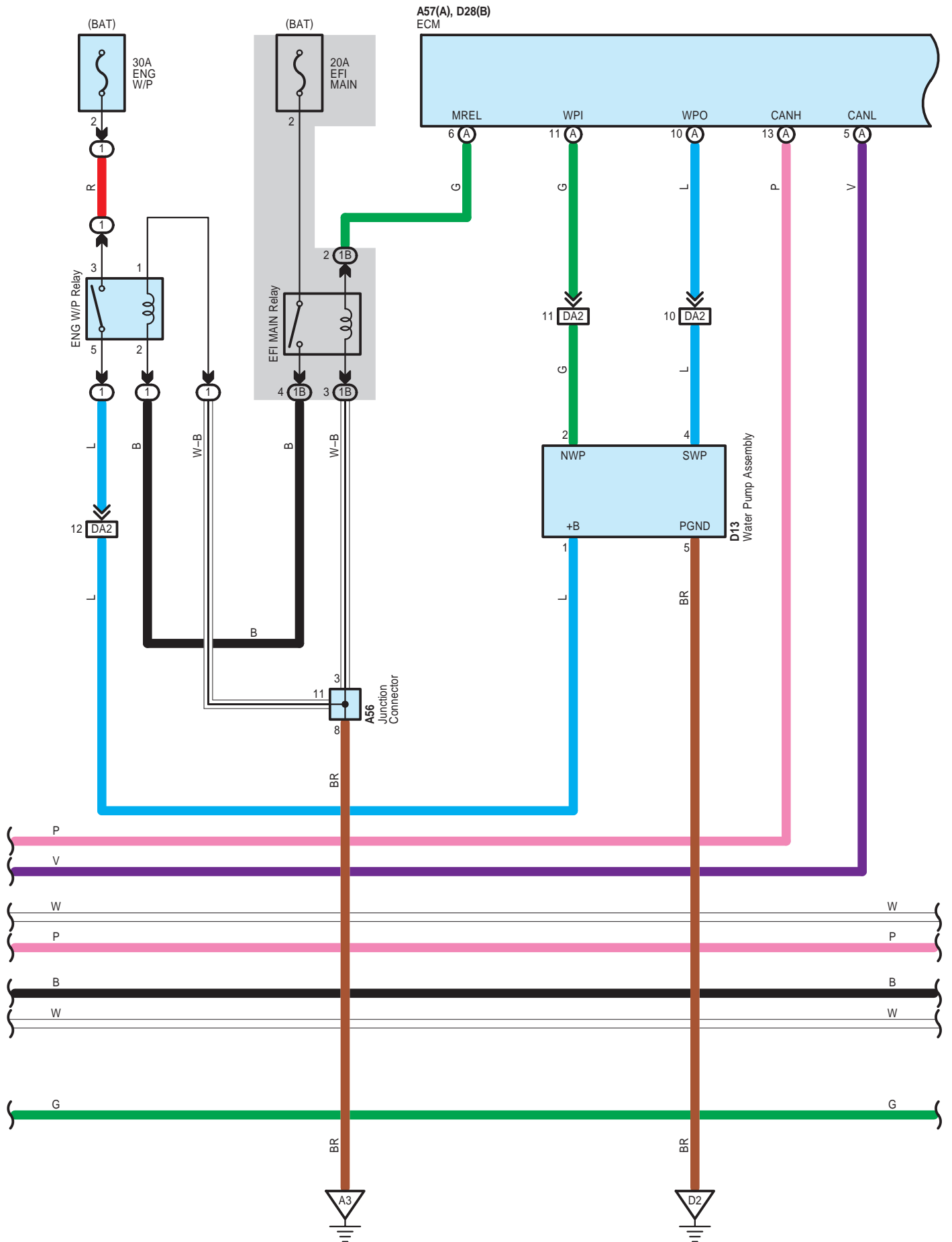

Air Conditioning

A57(A), D28(B)  
ECM

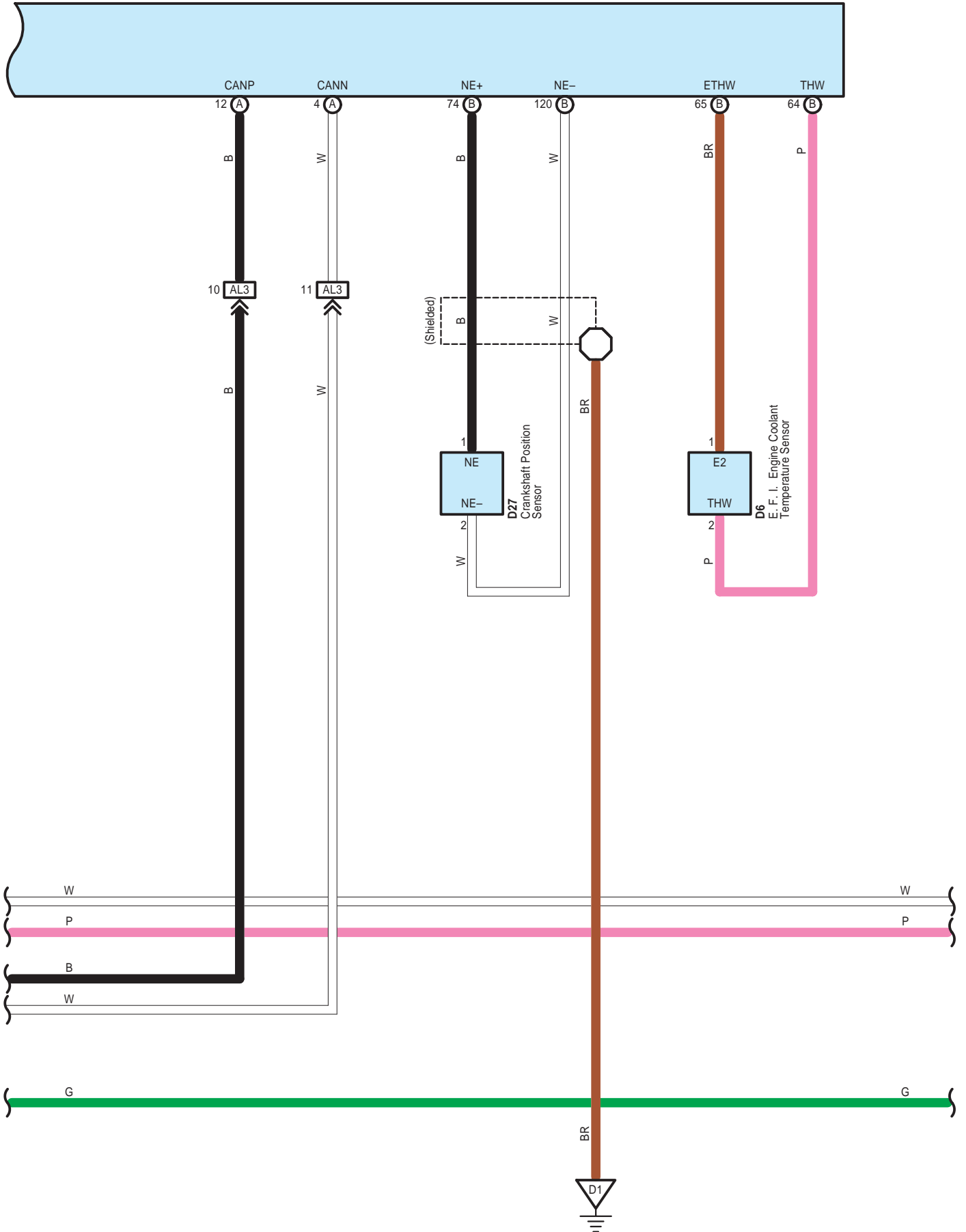

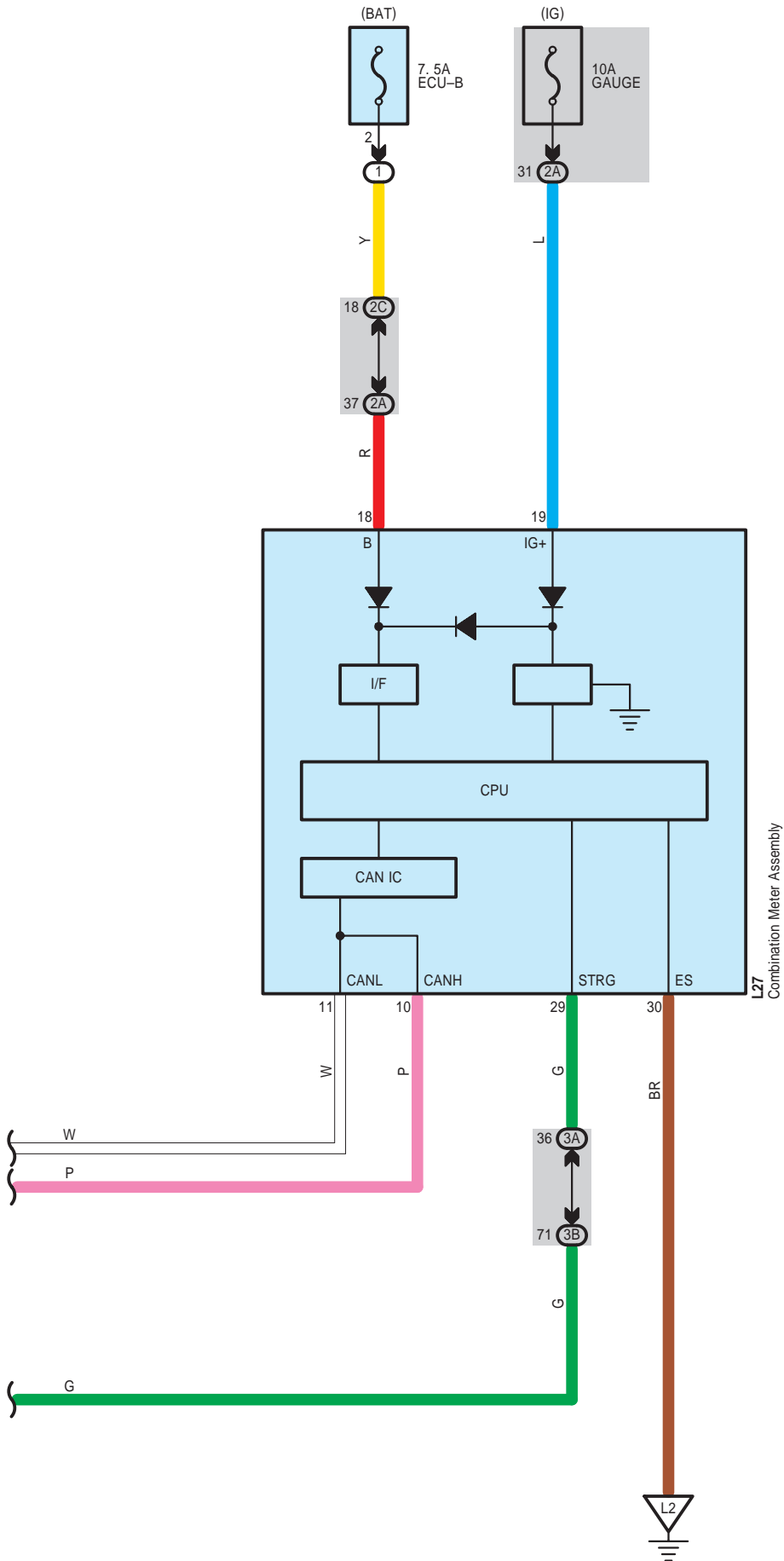





A 59  
Black

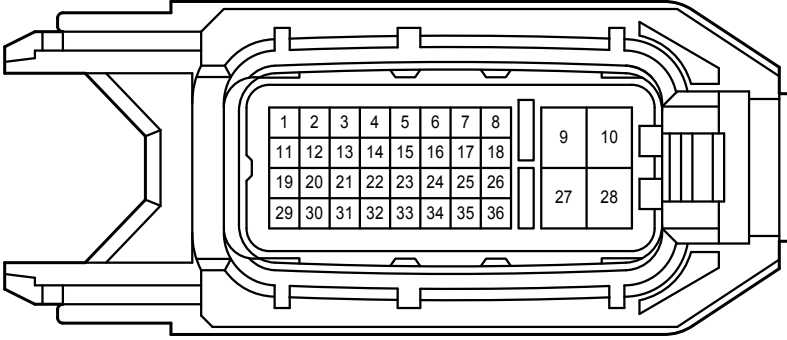

D 6  
Black



D 12  
Black

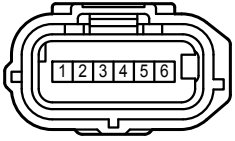

D 13  
Black



D 27  
Black

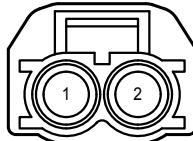

D 28  
Black

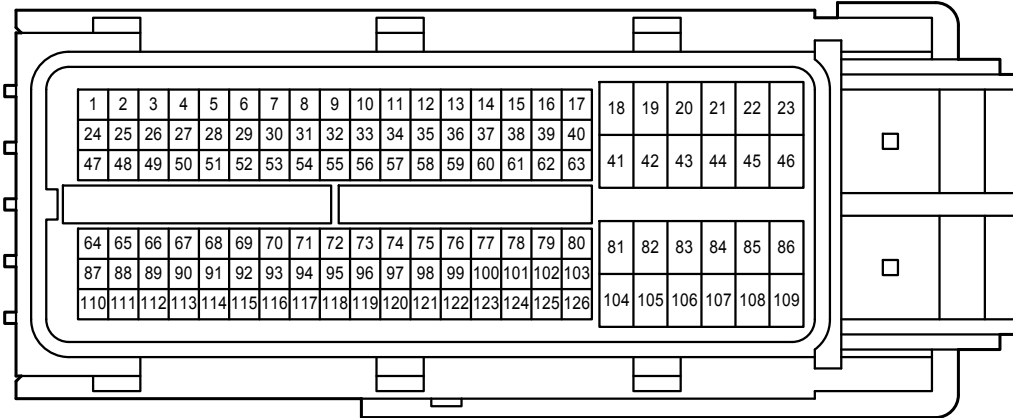

E 1  
Orange

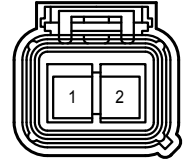

E 2  
White

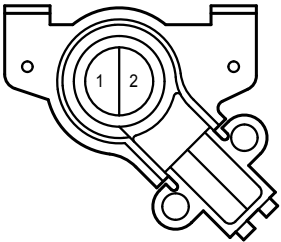

I 1  
Black

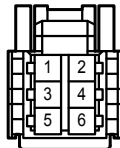

I 6  
White

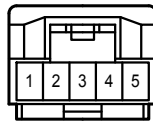

L 6  
Gray

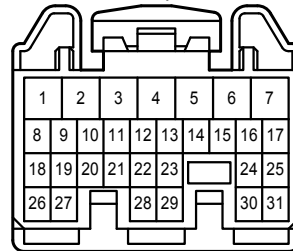

L 7  
White

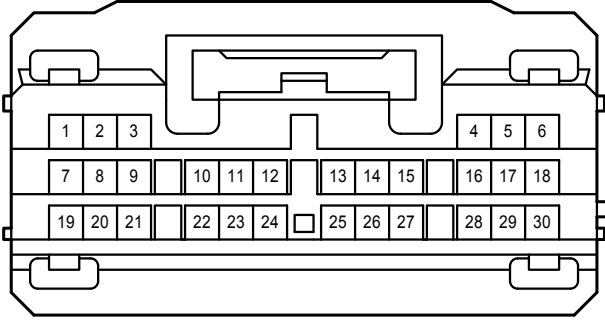

L 8  
White

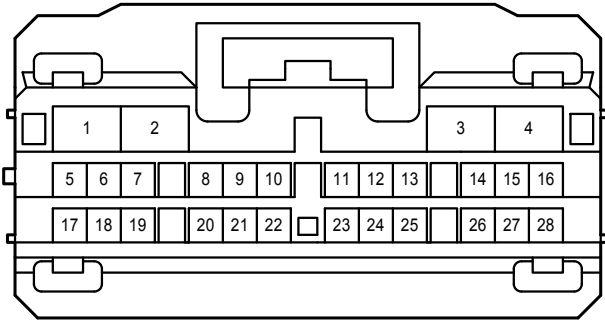

L 17  
White

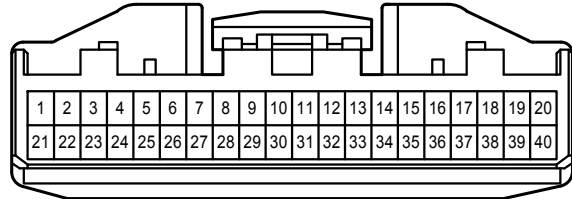

L 20  
Black

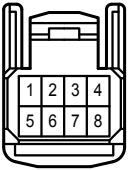

L 27  
White

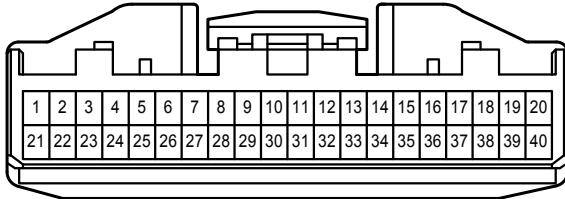

L 33  
Black

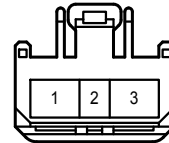

L 44  
Black



L 52  
Black



L 78  
Black

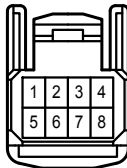

L 85  
White

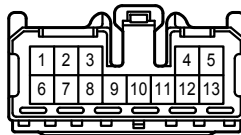

L 92  
White

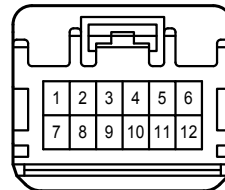

L 93  
White

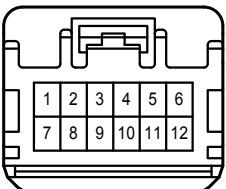

L 94  
White

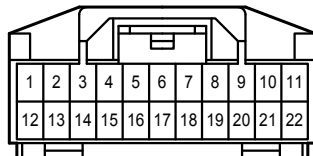

L 95  
White

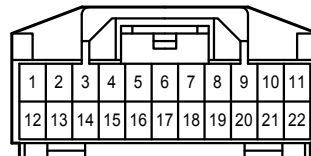

Air Conditioning

L101  
Black

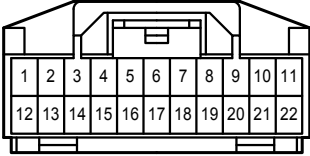

L104  
White

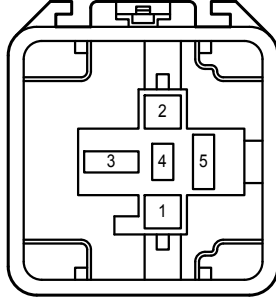

z 9  
Black

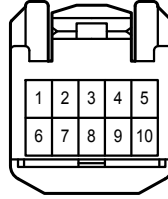

z 11  
White

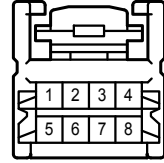

1B  
White

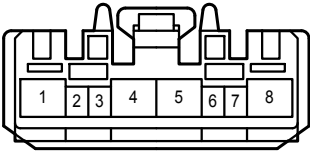

1G  
White

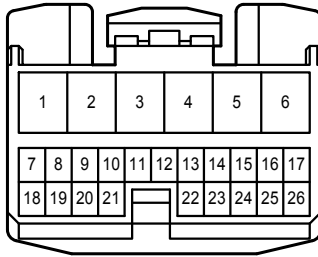

1H  
White

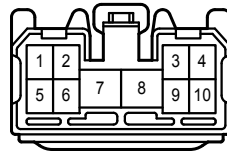

2A  
White

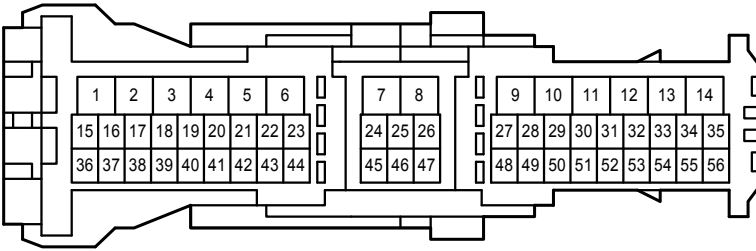

2B  
White

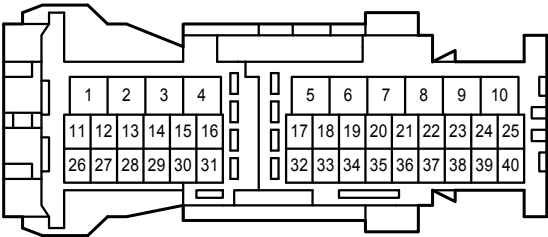

2C  
White

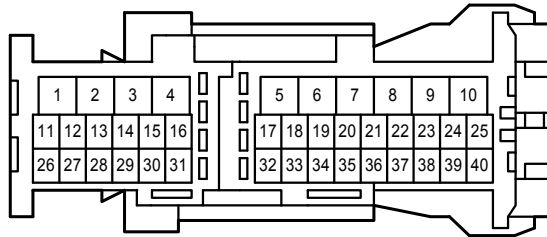

3A  
White

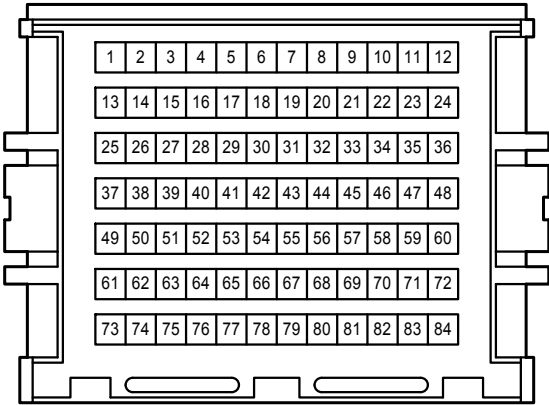

3B  
White

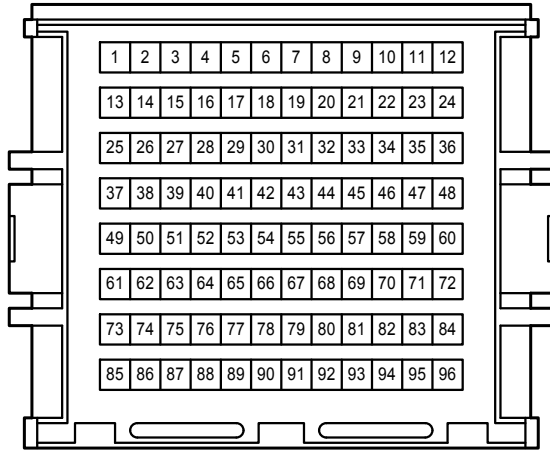

4A  
White

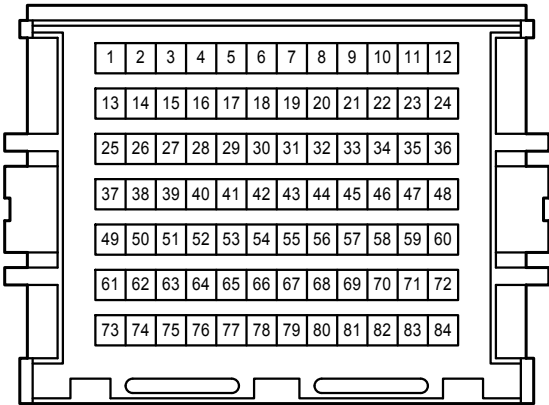

4B  
White

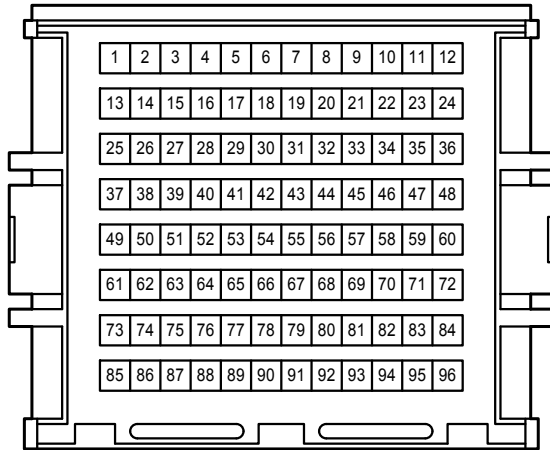

AL1  
Blue

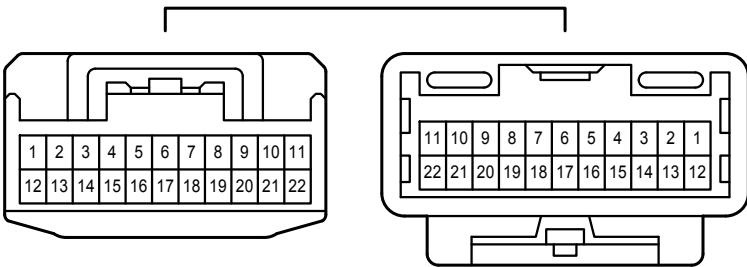

AL3  
White

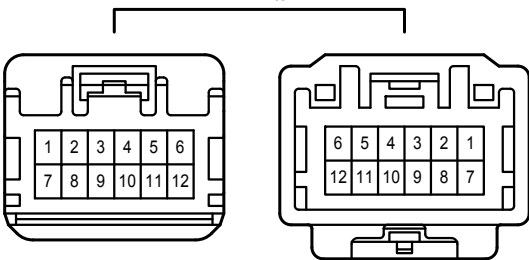

AL5  
White

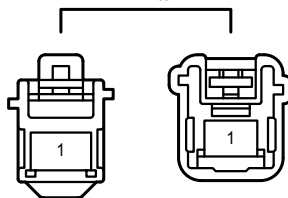

DA1  
White

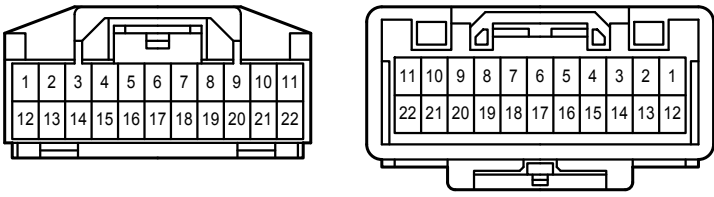

DA2  
White

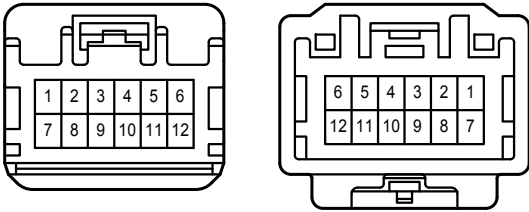

LI1  
Black

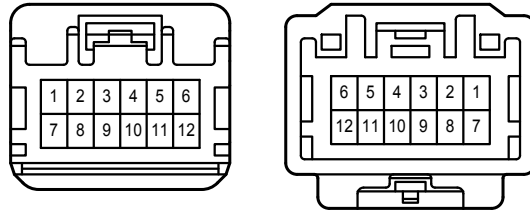

LI2  
White

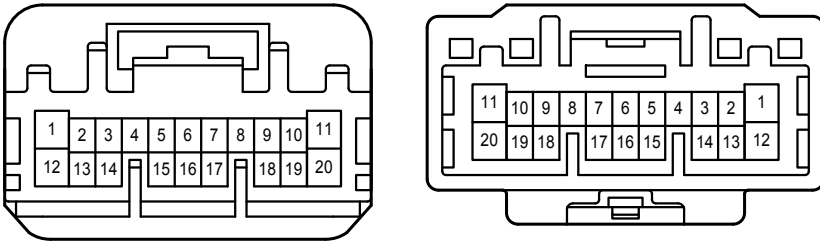

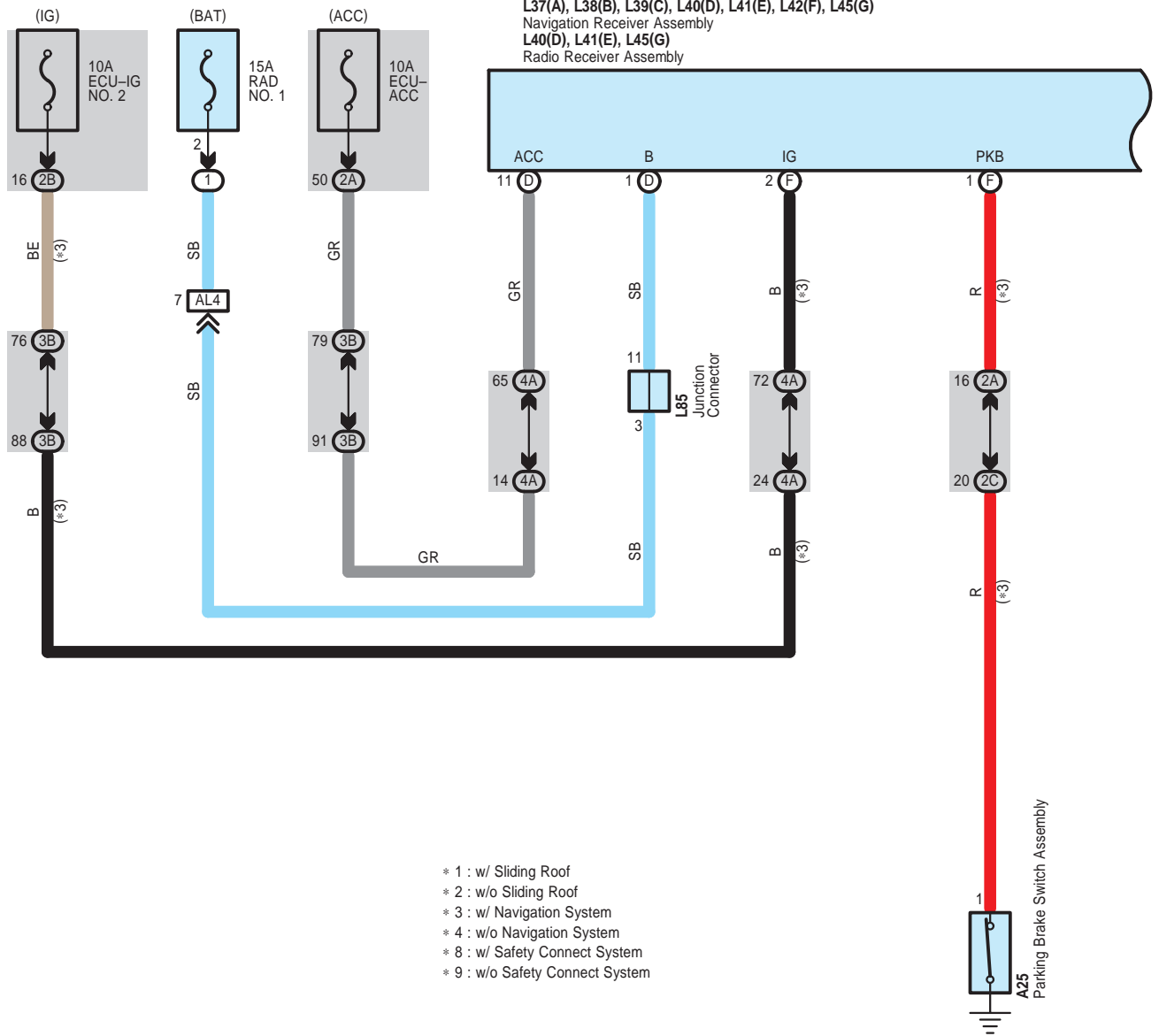

- \* 1 : w/ Sliding Roof
- \* 2 : w/o Sliding Roof
- \* 3 : w/ Navigation System
- \* 4 : w/o Navigation System
- \* 8 : w/ Safety Connect System
- \* 9 : w/o Safety Connect System

L37(A), L38(B), L39(C), L40(D), L41(E), L42(F), L45(G)  
 Navigation Receiver Assembly  
 L40(D), L41(E), L45(G)  
 Radio Receiver Assembly

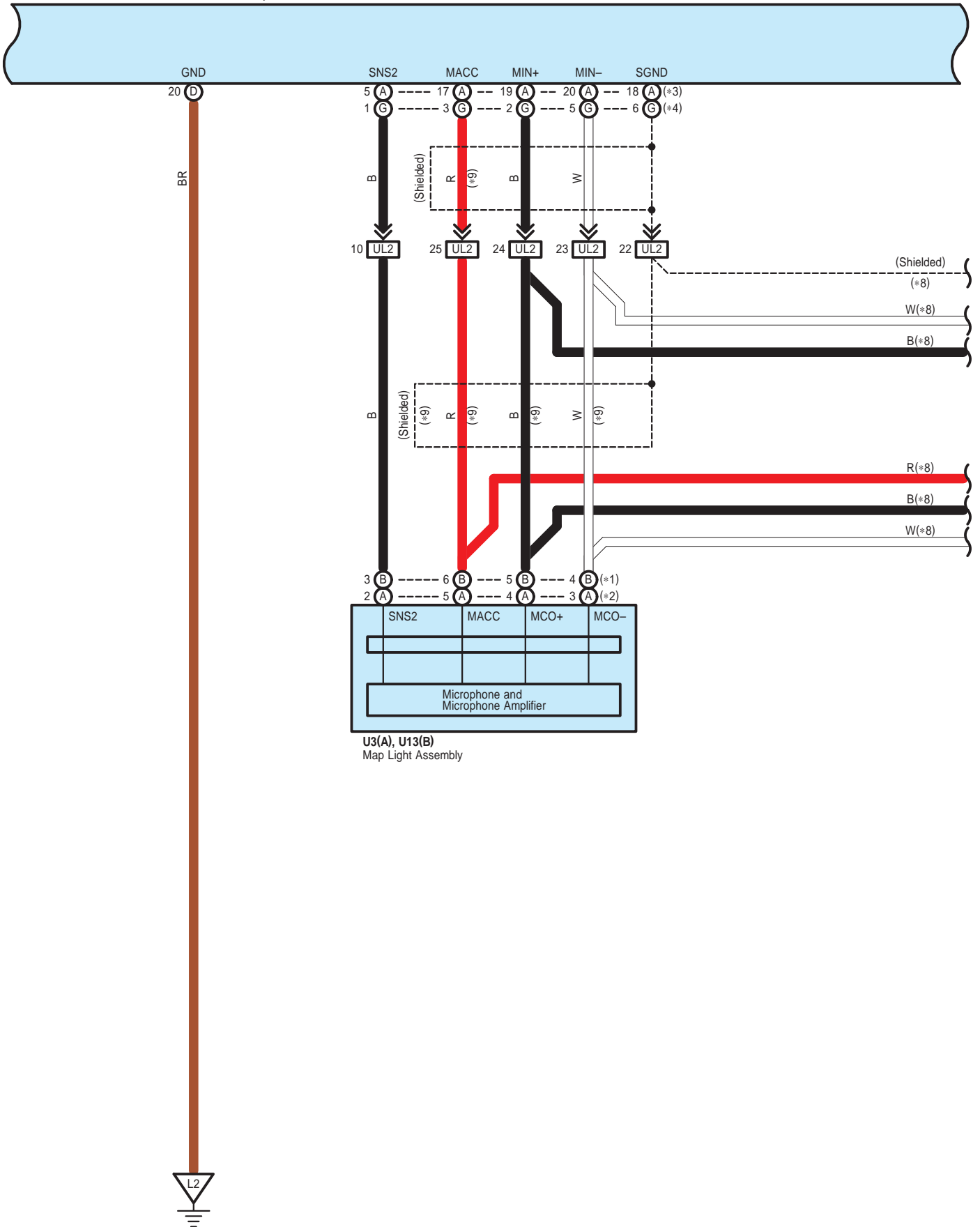

L37(A), L38(B), L39(C), L40(D), L41(E), L42(F), L45(G)  
 Navigation Receiver Assembly  
 L40(D), L41(E), L45(G)  
 Radio Receiver Assembly

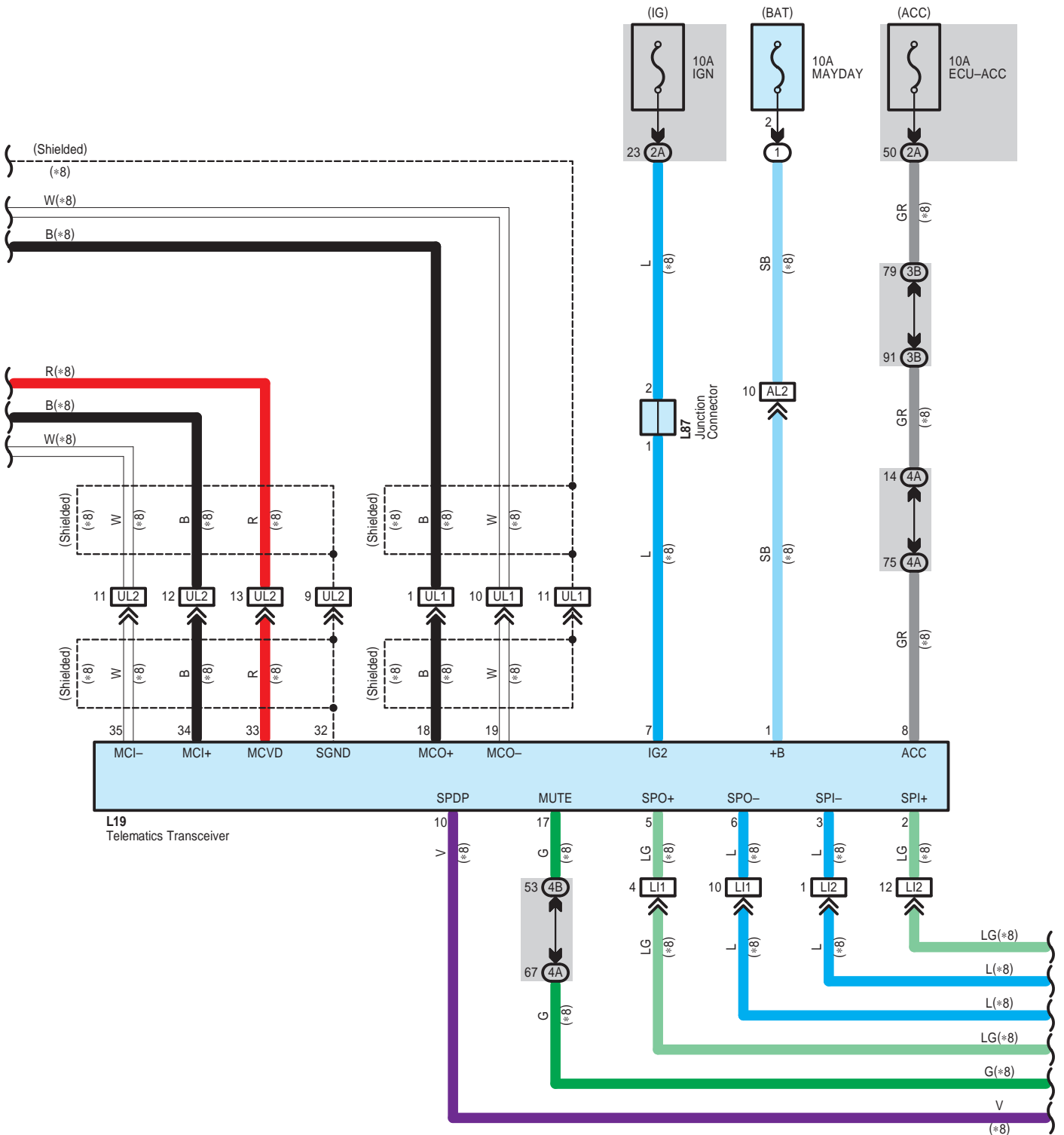



L37(A), L38(B), L39(C), L40(D), L41(E), L42(F), L45(G)  
 Navigation Receiver Assembly  
 L40(D), L41(E), L45(G)  
 Radio Receiver Assembly

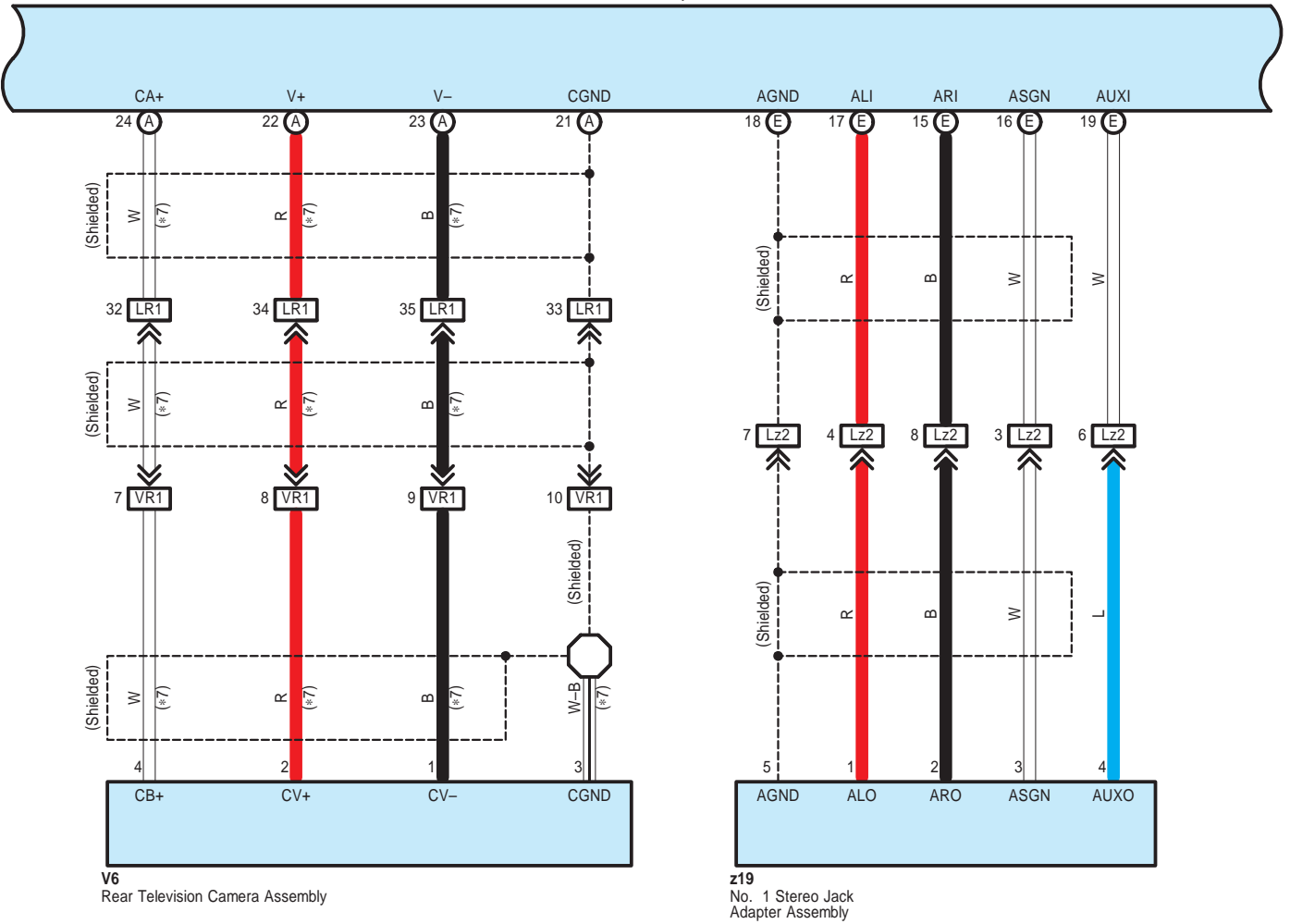

\* 7 : w/ Rear View Monitor  
 \* 8 : w/ Safety Connect System



L37(A), L38(B), L39(C), L40(D), L41(E), L42(F), L45(G)  
 Navigation Receiver Assembly  
 L40(D), L41(E), L45(G)  
 Radio Receiver Assembly

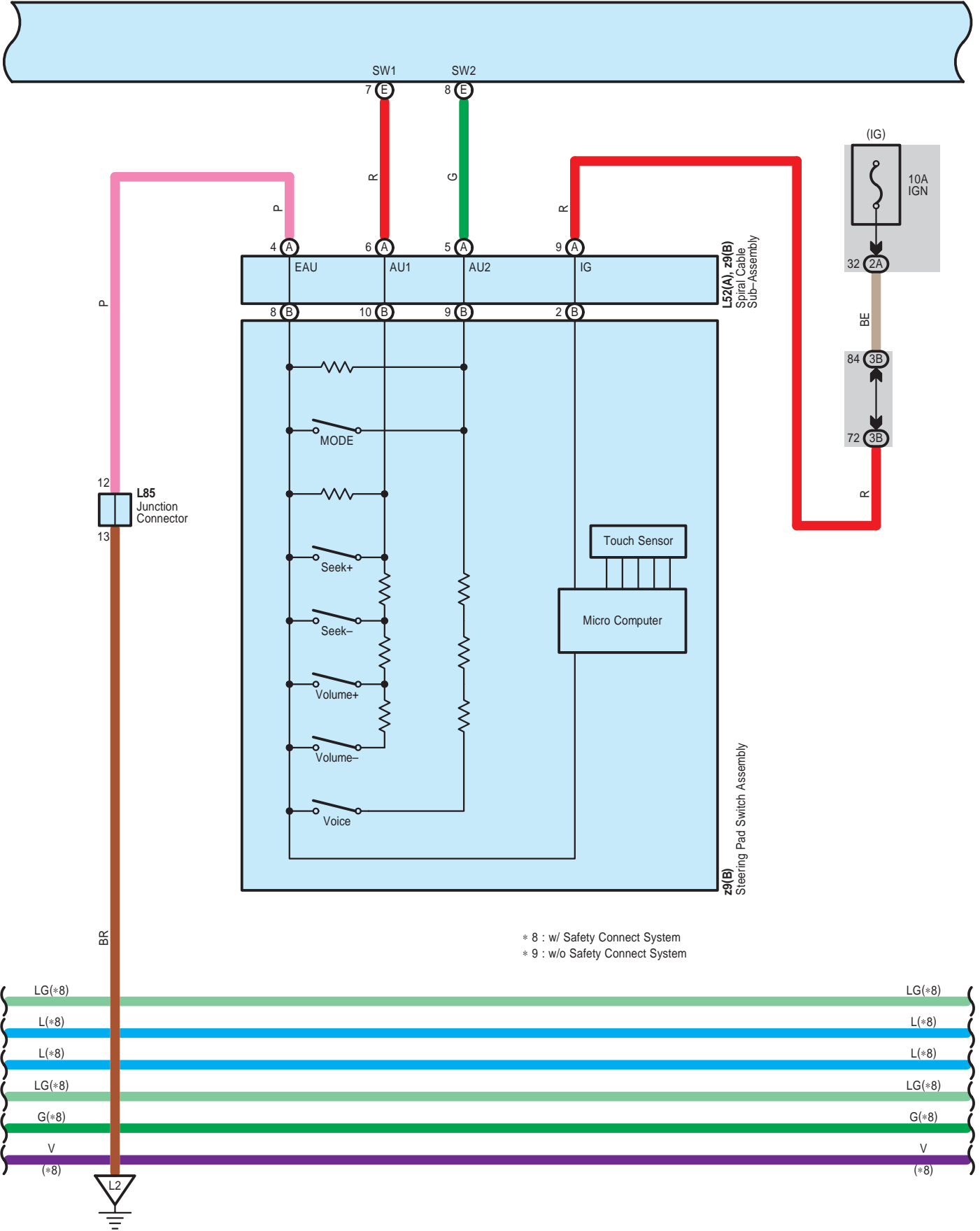

\* 8 : w/ Safety Connect System  
 \* 9 : w/o Safety Connect System

L37(A), L38(B), L39(C), L40(D), L41(E), L42(F), L45(G)  
 Navigation Receiver Assembly  
 L40(D), L41(E), L45(G)  
 Radio Receiver Assembly

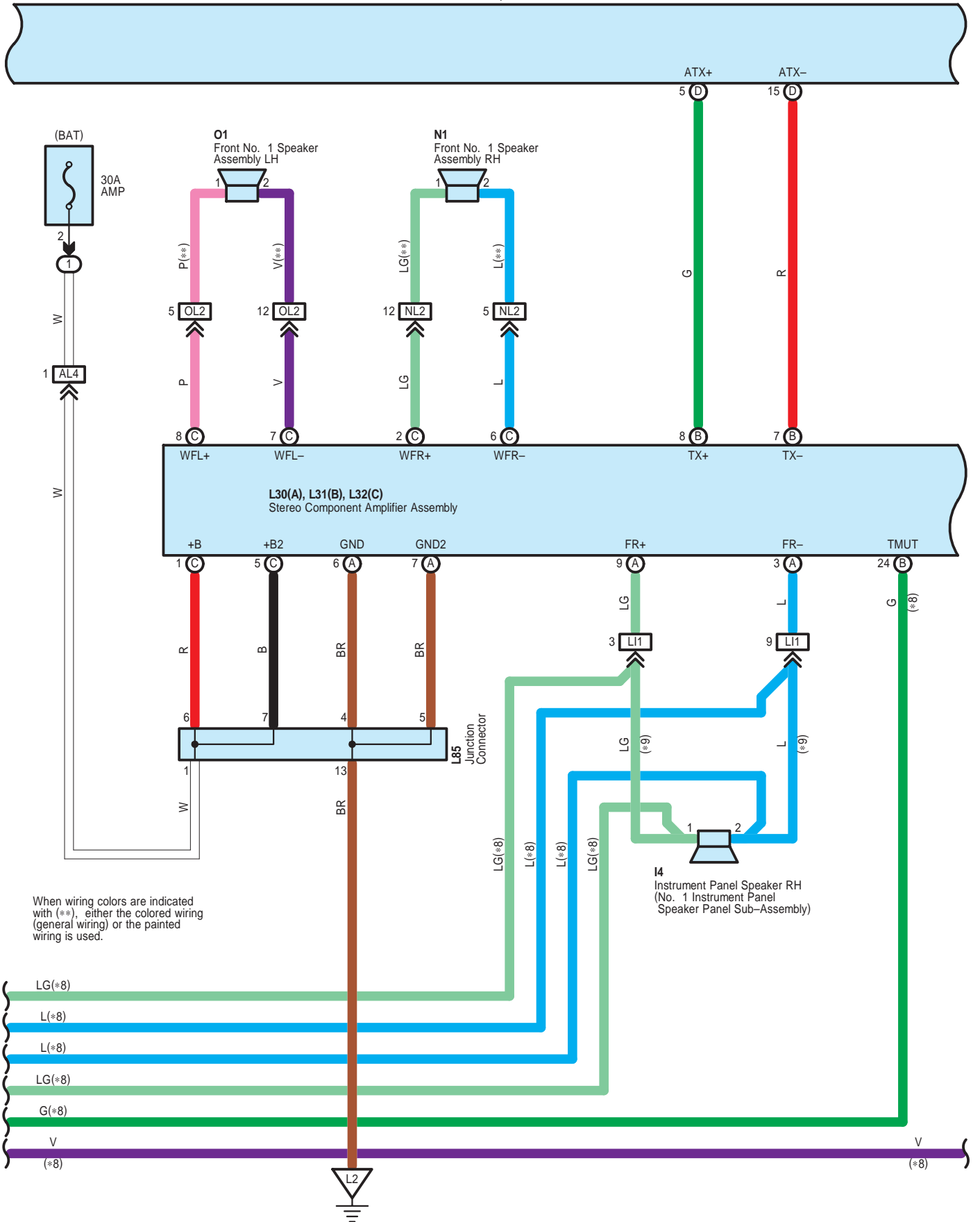

When wiring colors are indicated with (\*\*), either the colored wiring (general wiring) or the painted wiring is used.

L37(A), L38(B), L39(C), L40(D), L41(E), L42(F), L45(G)  
 Navigation Receiver Assembly  
 L40(D), L41(E), L45(G)  
 Radio Receiver Assembly

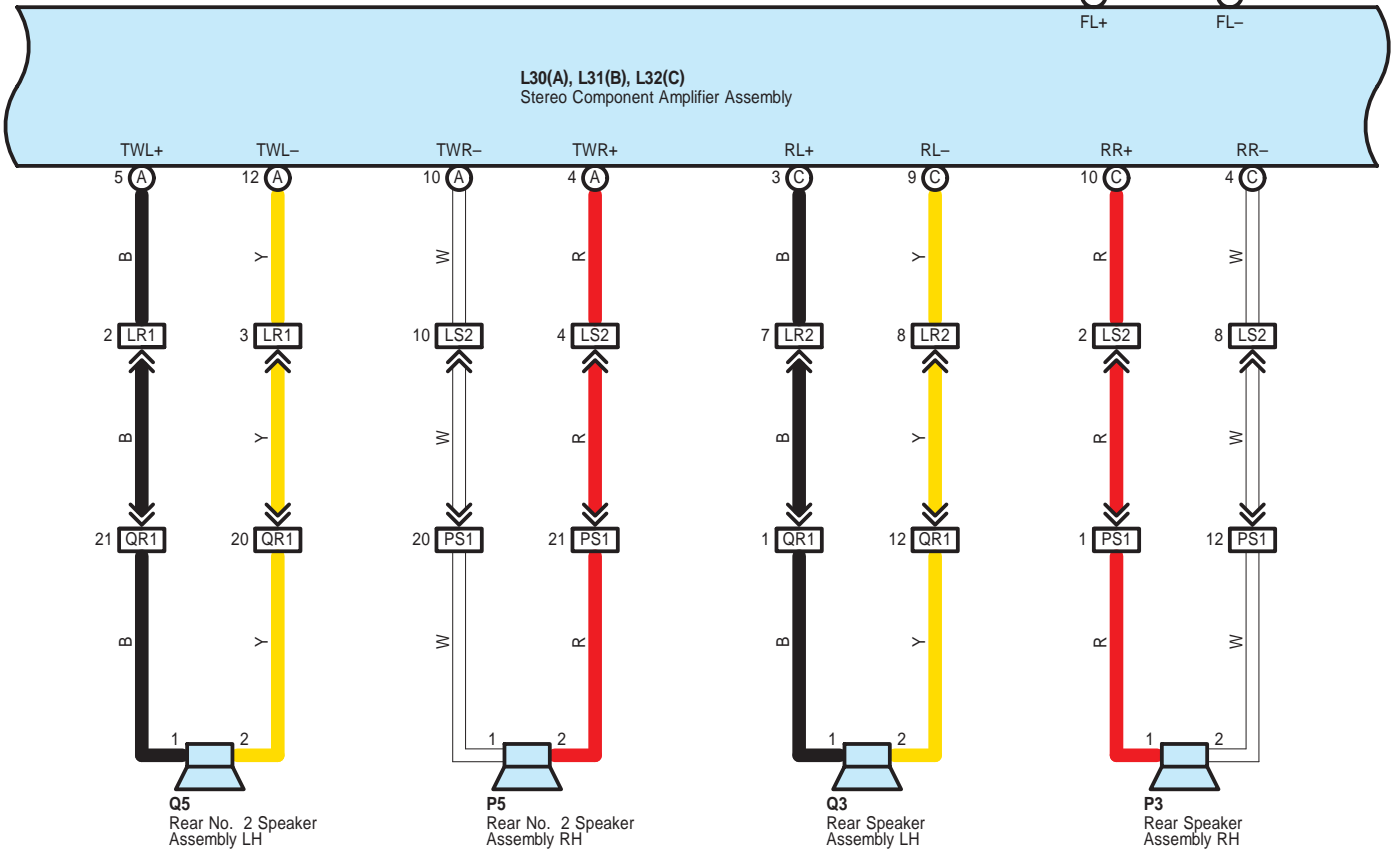
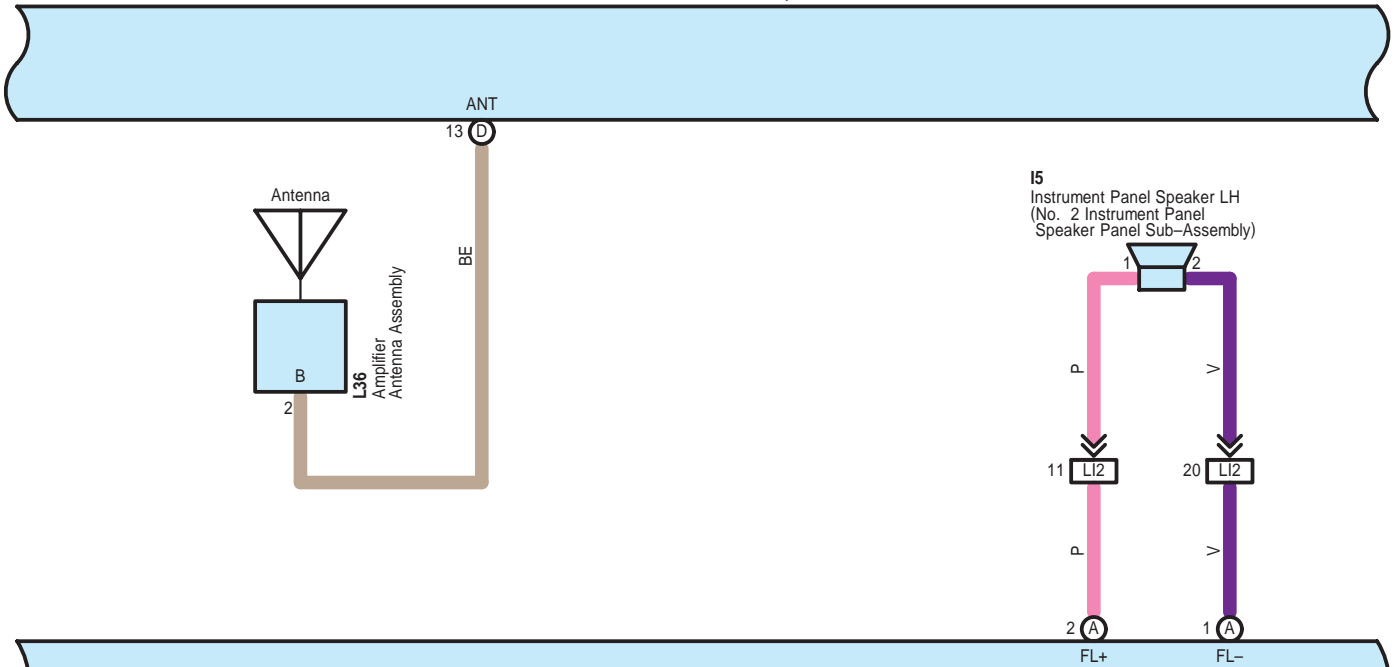

L37(A), L38(B), L39(C), L40(D), L41(E), L42(F), L45(G)  
 Navigation Receiver Assembly  
 L40(D), L41(E), L45(G)  
 Radio Receiver Assembly

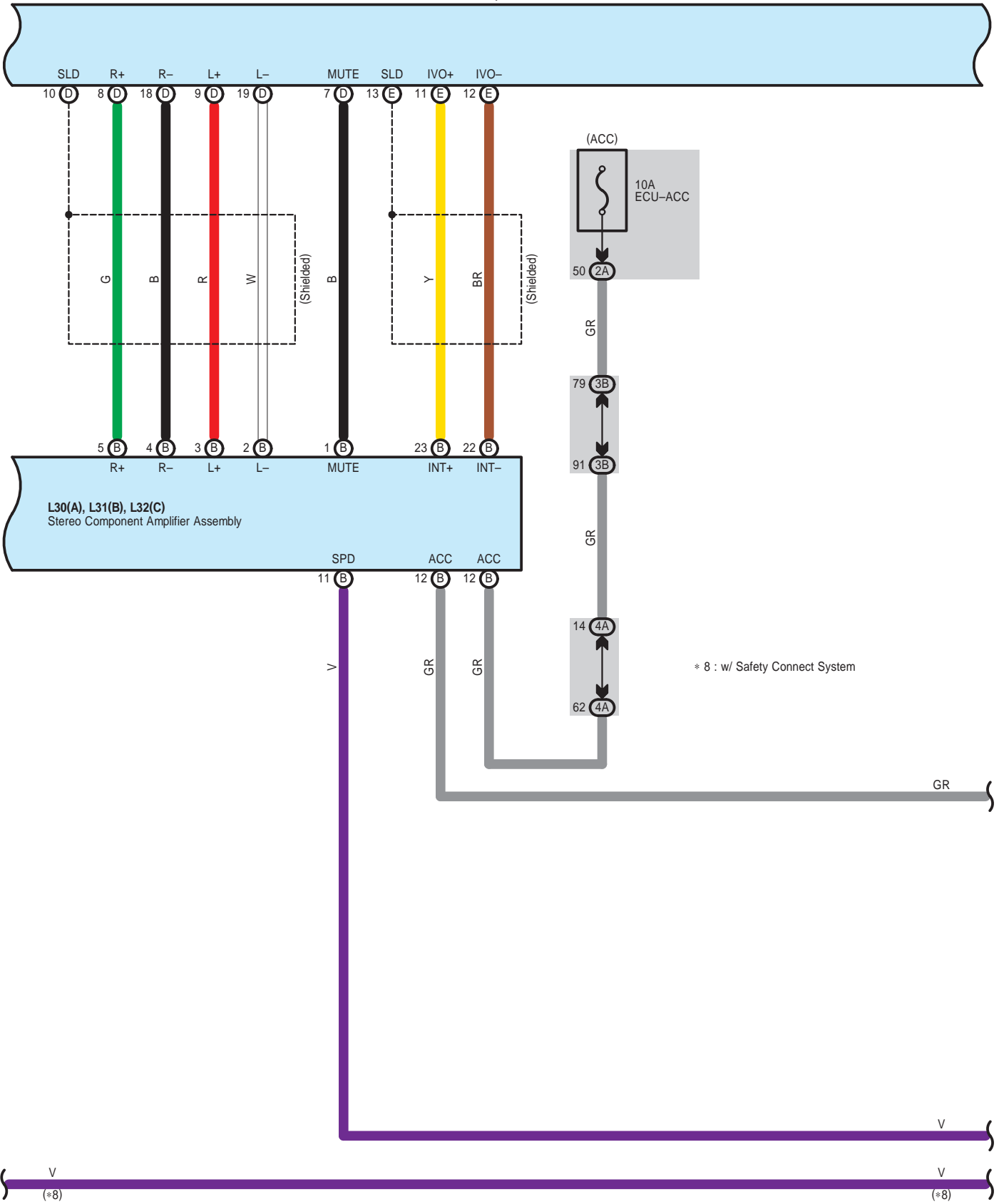

L37(A), L38(B), L39(C), L40(D), L41(E), L42(F), L45(G)  
 Navigation Receiver Assembly  
 L40(D), L41(E), L45(G)  
 Radio Receiver Assembly

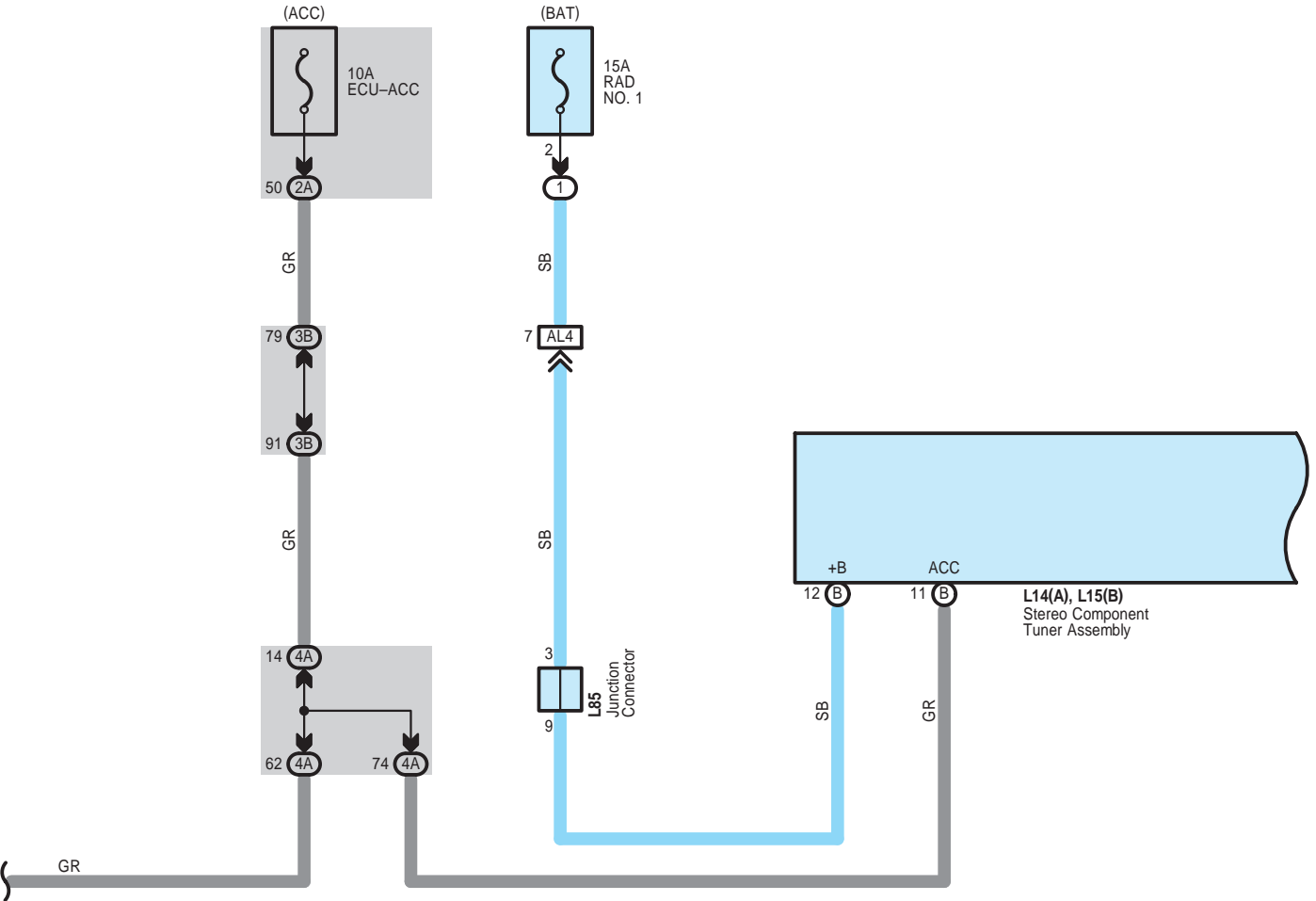
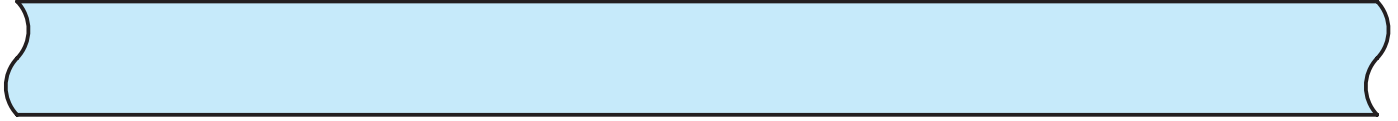

L37(A), L38(B), L39(C), L40(D), L41(E), L42(F), L45(G)  
 Navigation Receiver Assembly  
 L40(D), L41(E), L45(G)  
 Radio Receiver Assembly

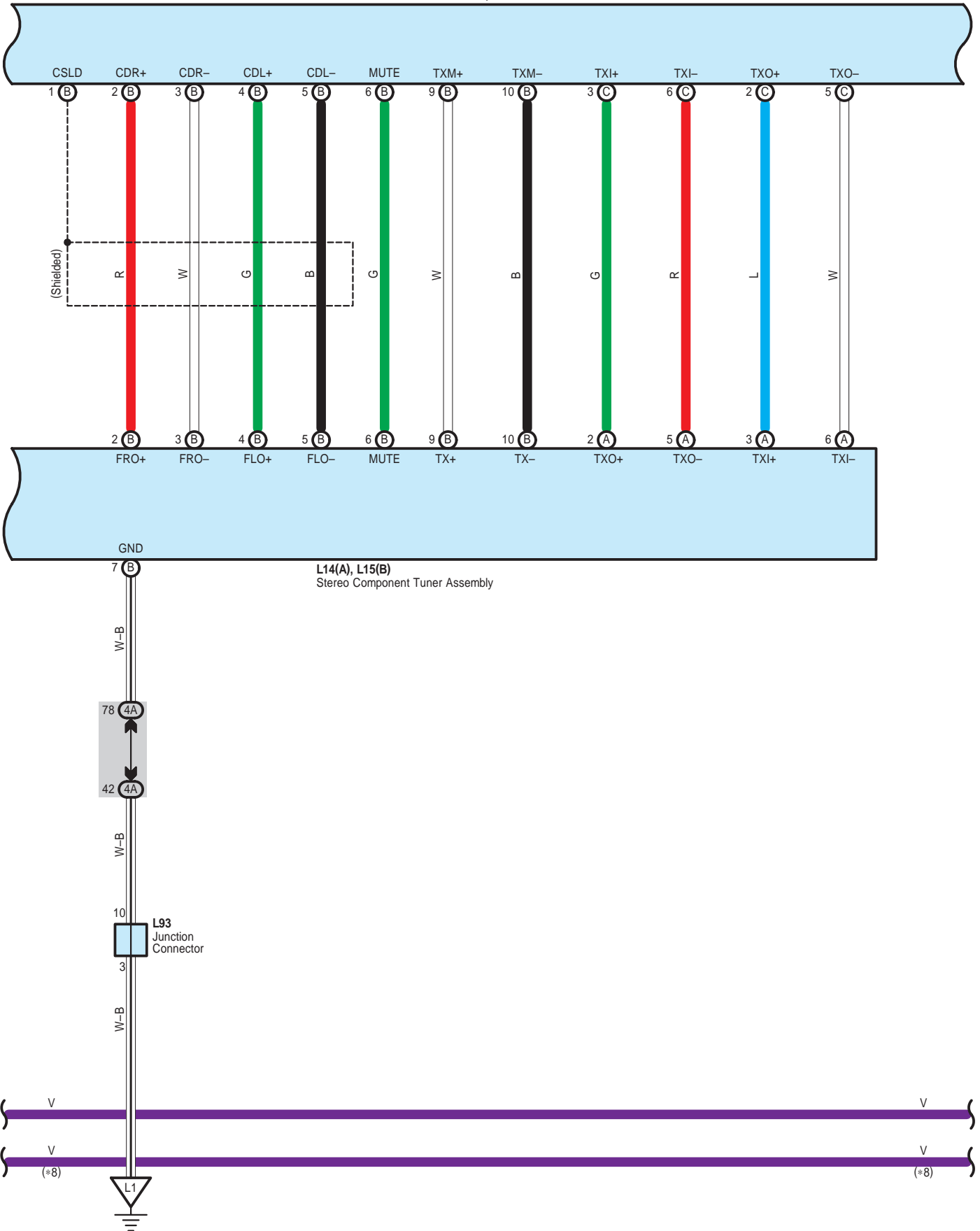

L37(A), L38(B), L39(C), L40(D), L41(E), L42(F), L45(G)  
 Navigation Receiver Assembly  
 L40(D), L41(E), L45(G)  
 Radio Receiver Assembly

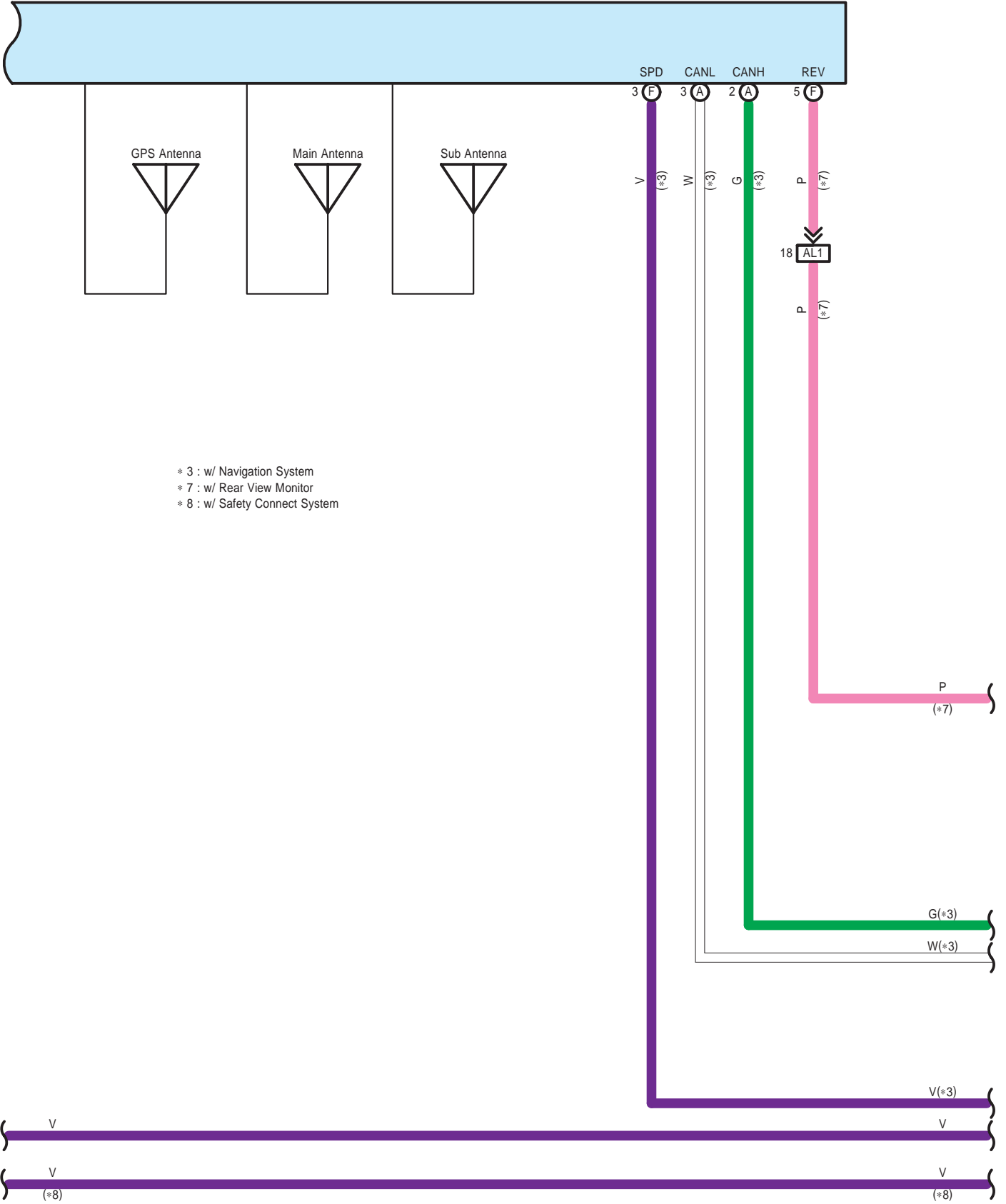





- \* 3 : w/ Navigation System
- \* 7 : w/ Rear View Monitor
- \* 8 : w/ Safety Connect System

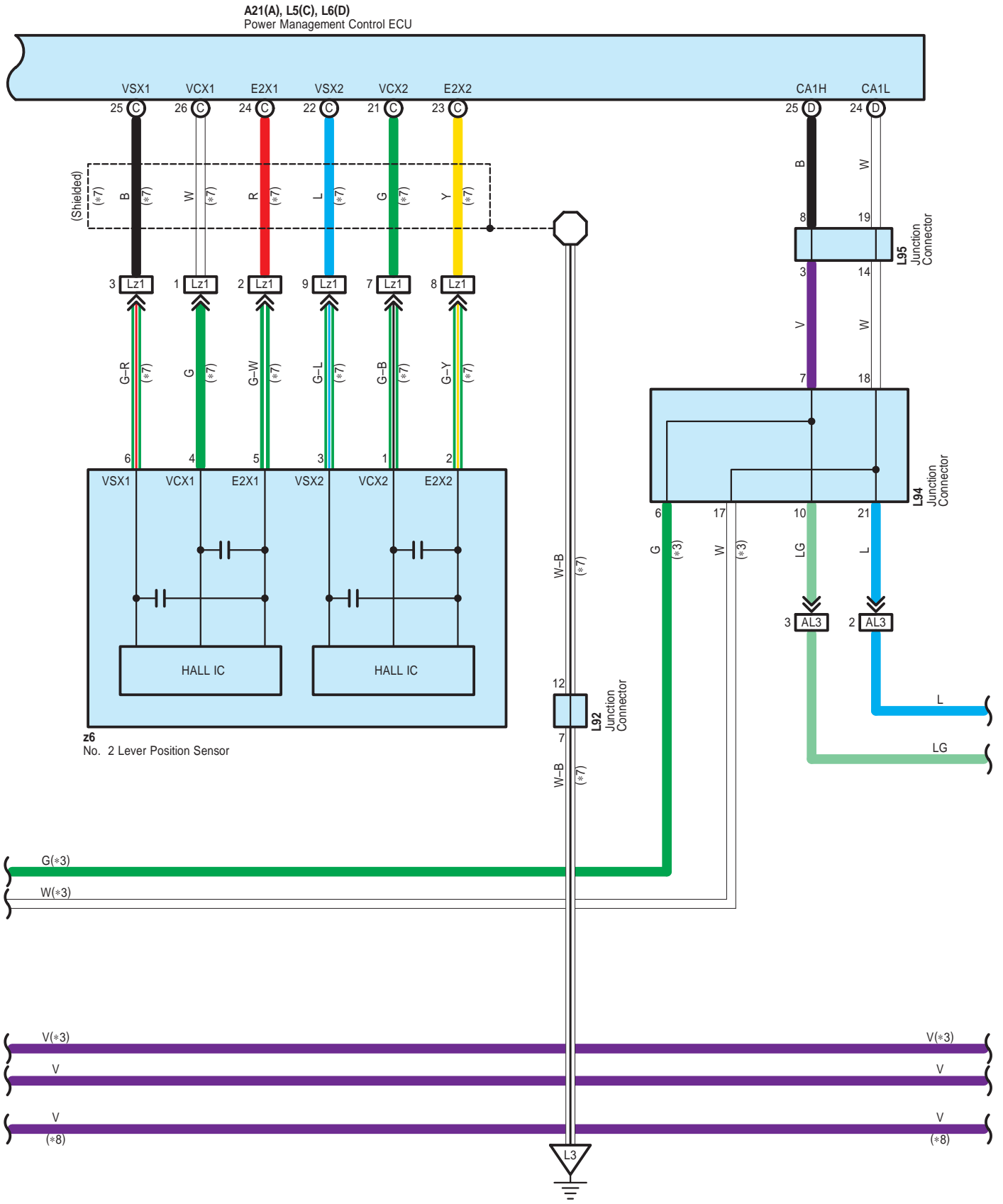

A58  
Skid Control ECU with Actuator Assembly

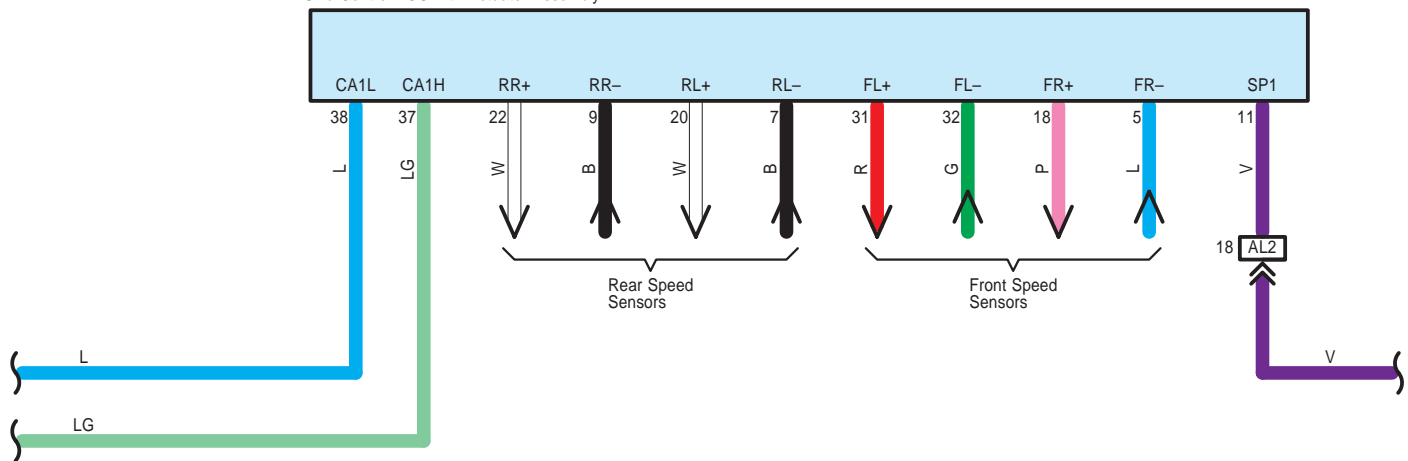

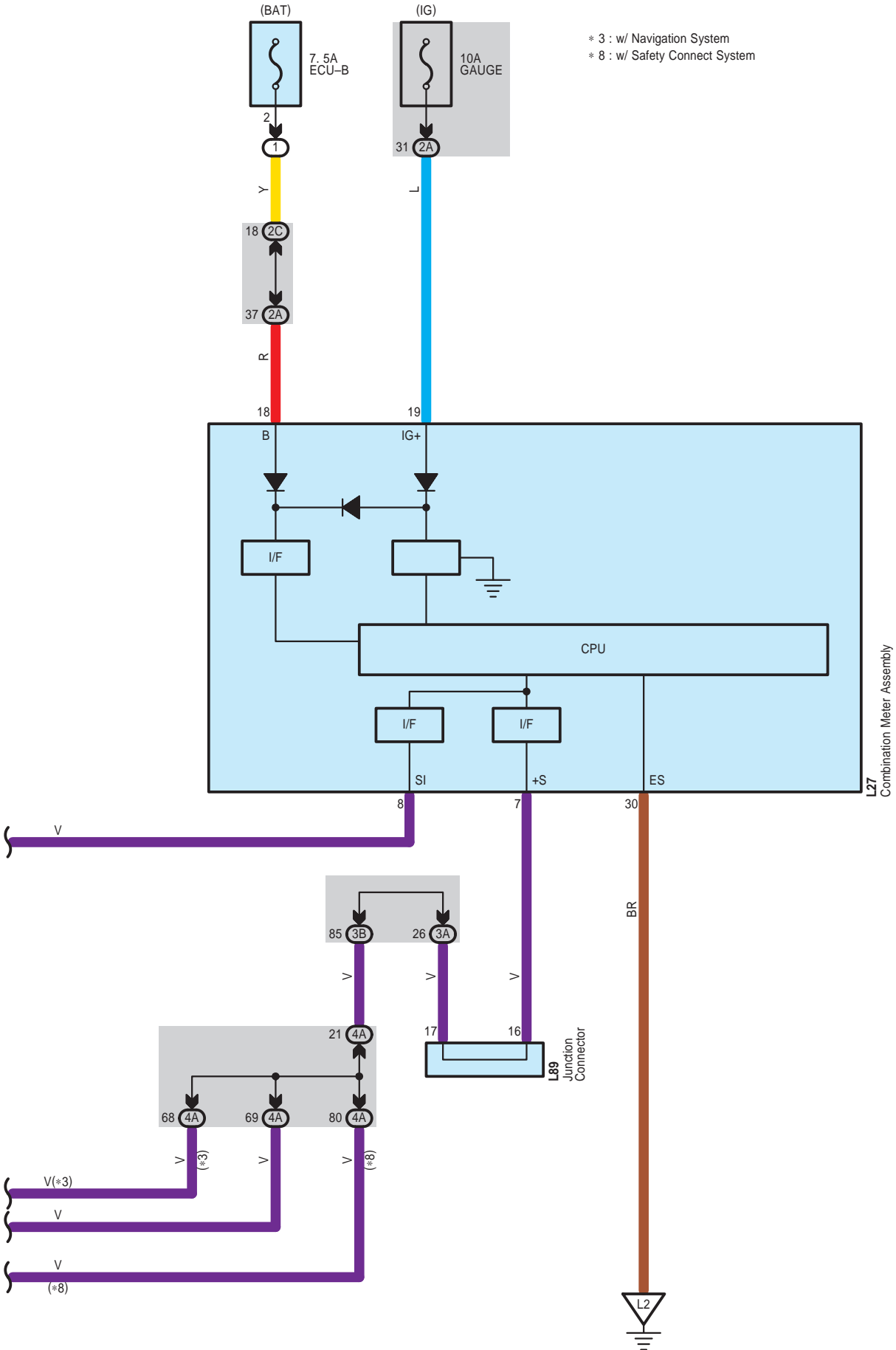



L 27  
White

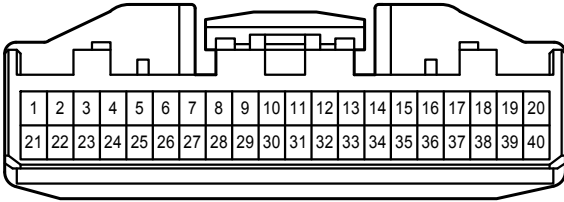

L 30  
White

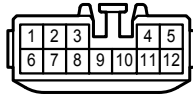

L 31  
White

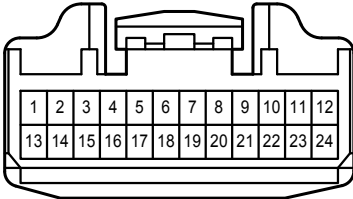

L 32  
Blue

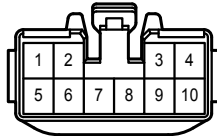

L 36  
White



L 37  
White

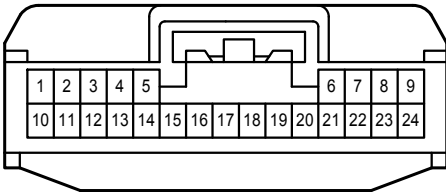

L 38  
Black

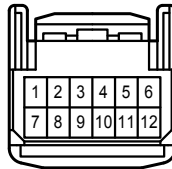

L 39  
Blue

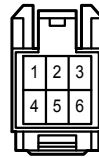

L 40  
White

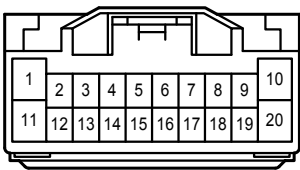

L 41  
White

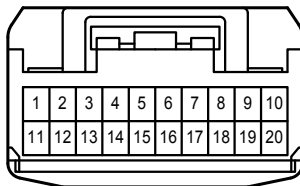

L 42  
Gray

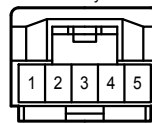

L 45  
White

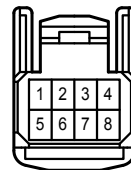

L 52  
Black

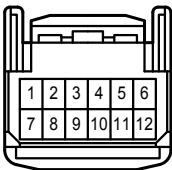

L 85  
White

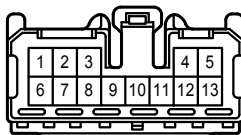

L 87  
Black

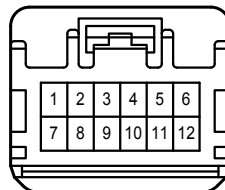

L 89  
Black

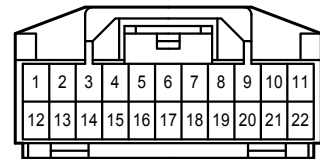

L 92  
White

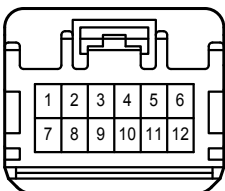

L 93  
White

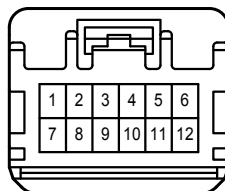

L 94  
White

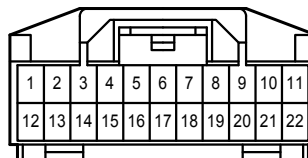

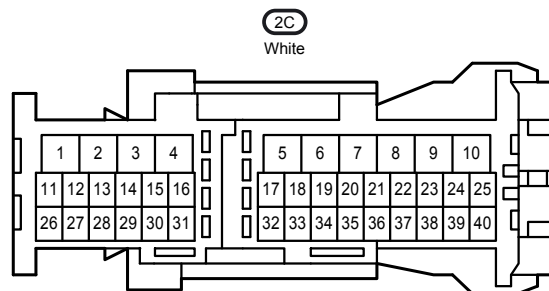
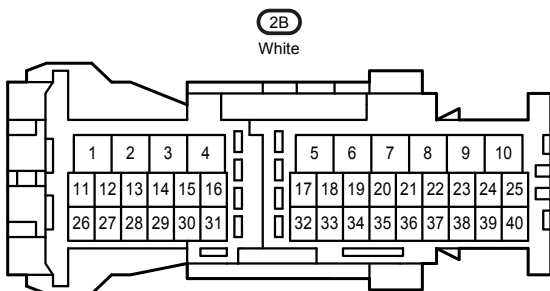
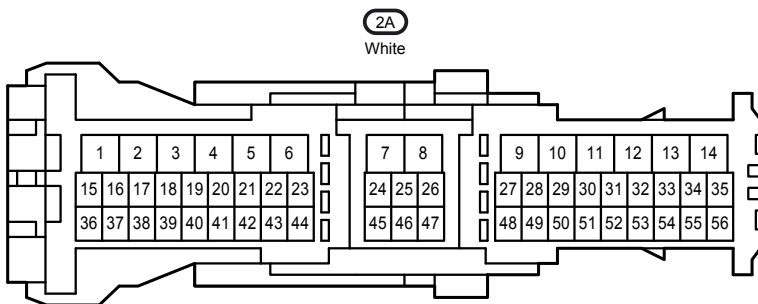
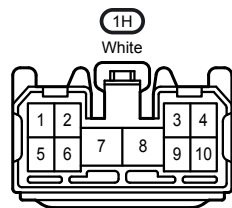
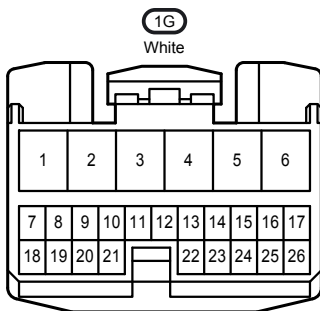
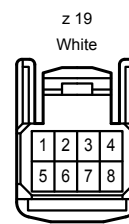
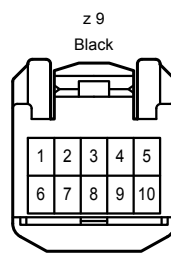
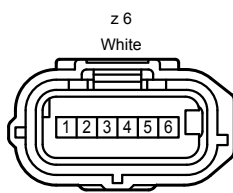
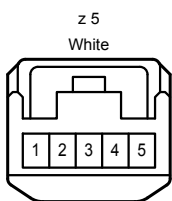
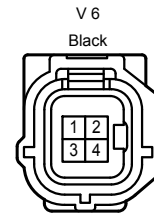
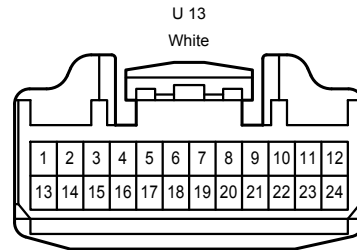
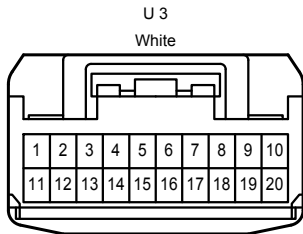
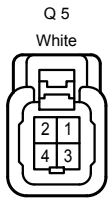
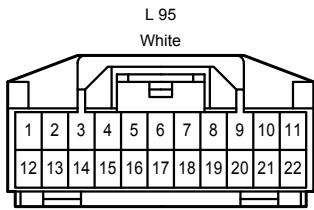

3A

White

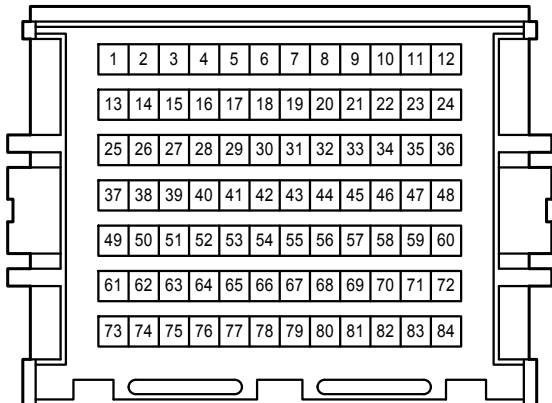

3B

White

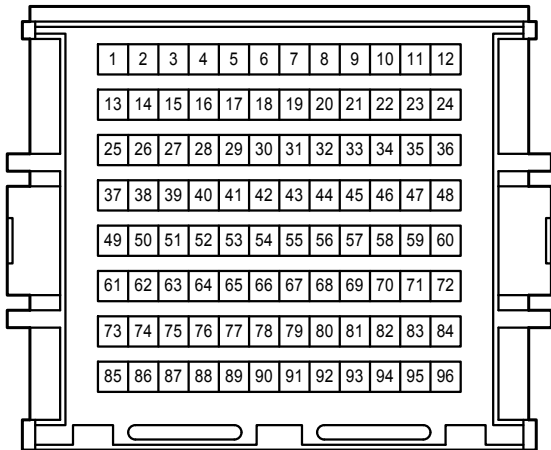

4A

White

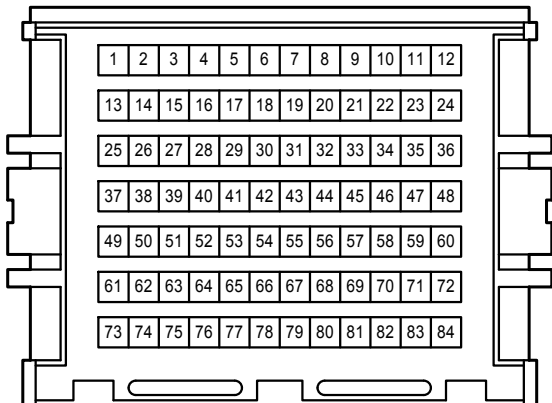

4B

White

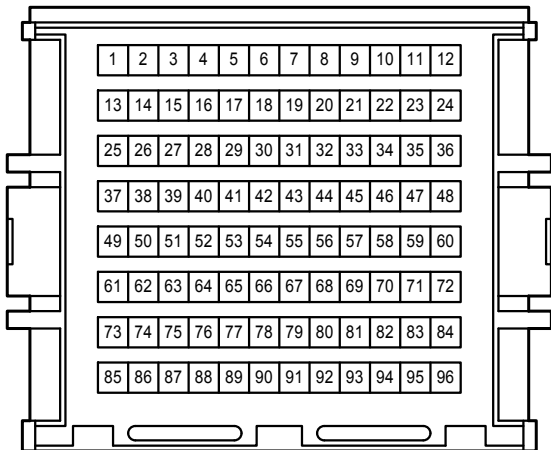

AL1

Blue

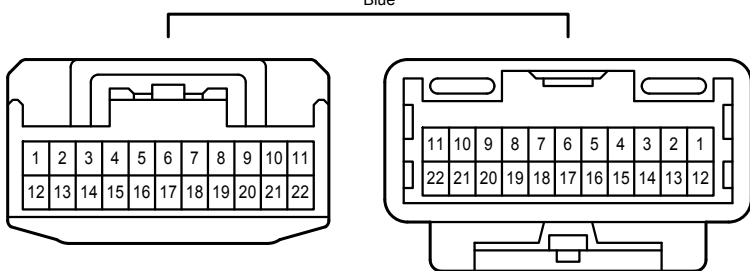

AL2

Gray

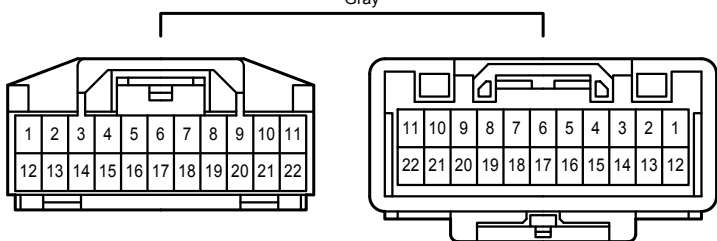



AL3  
White

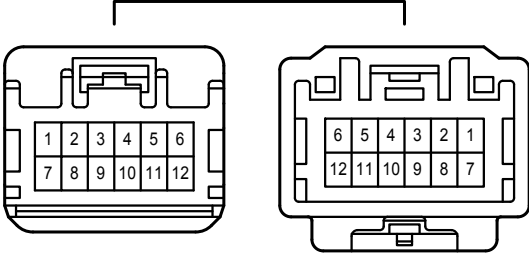

AL4  
Black

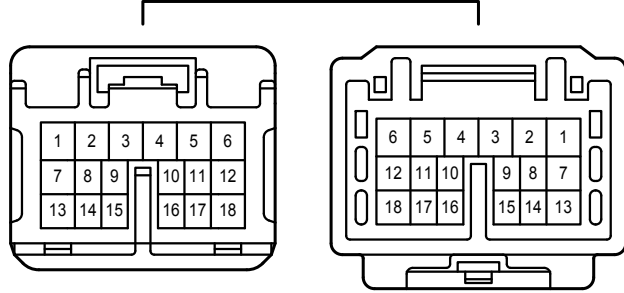

L11  
Black

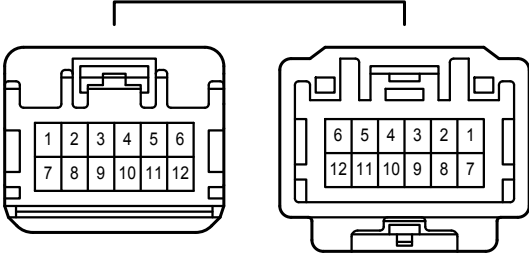

L12  
White

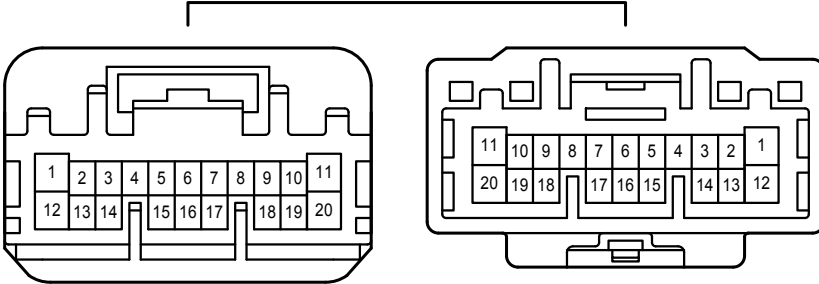

LR1  
White

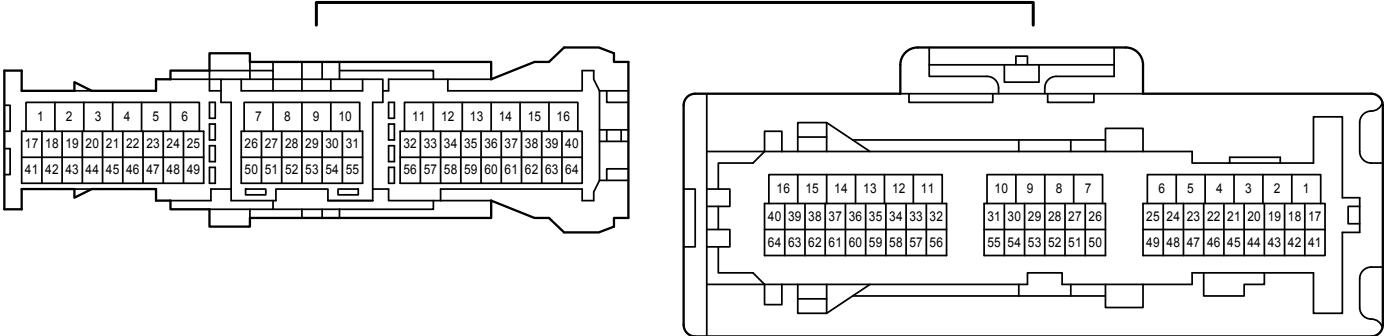

LR2  
Black

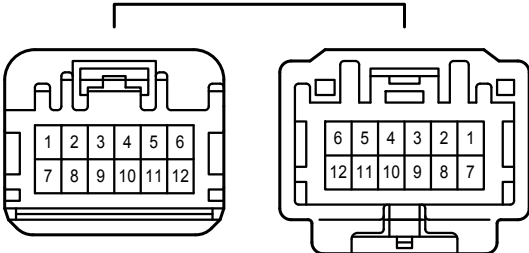

LS2  
Black

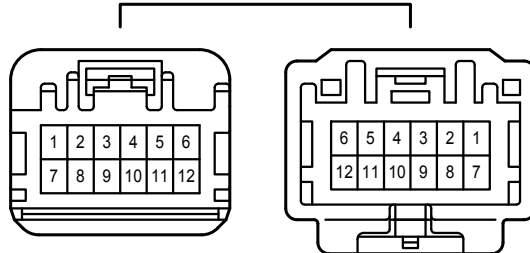

Lz1  
White

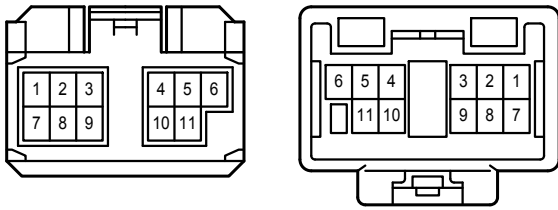

Lz2  
White

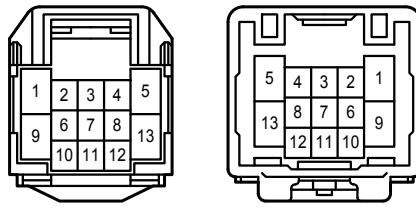

NL2  
White

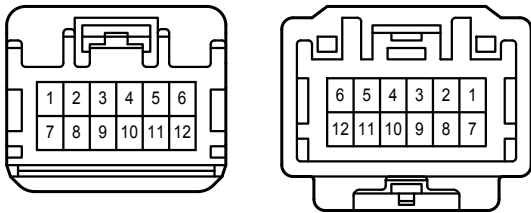

OL2  
White

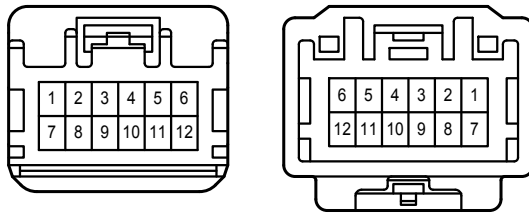

PS1  
White

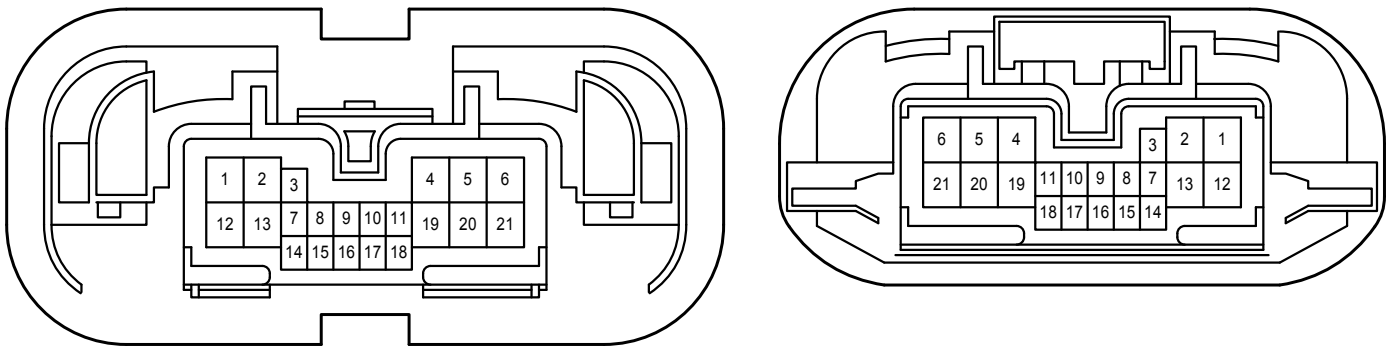

QR1  
White

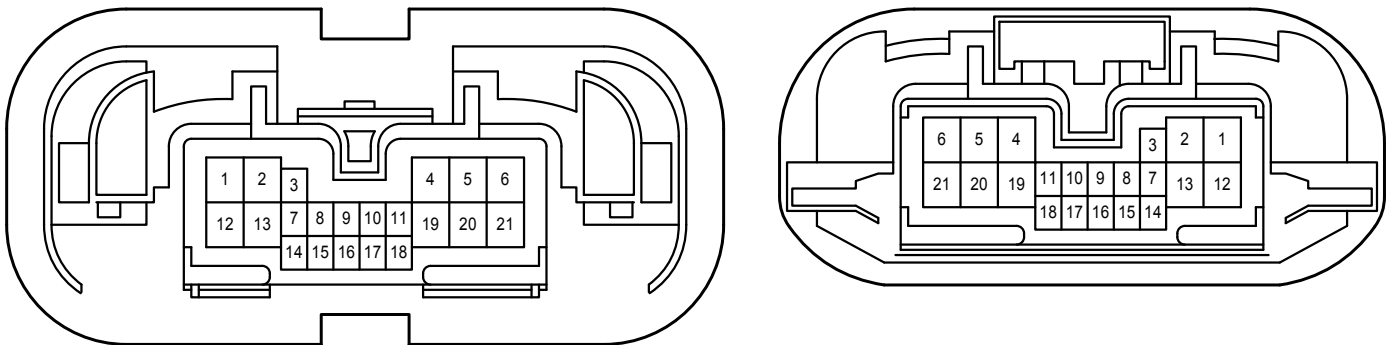

UL1  
Gray

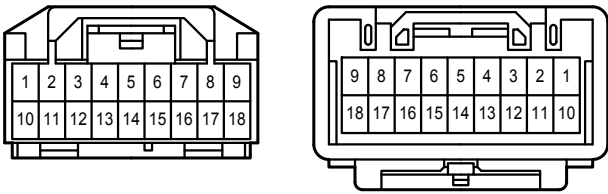

UL2  
White

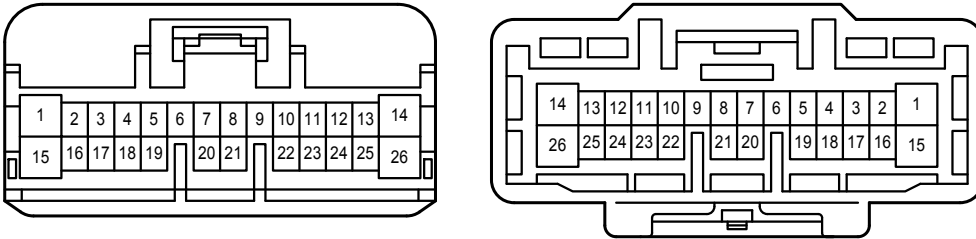

VR1  
White

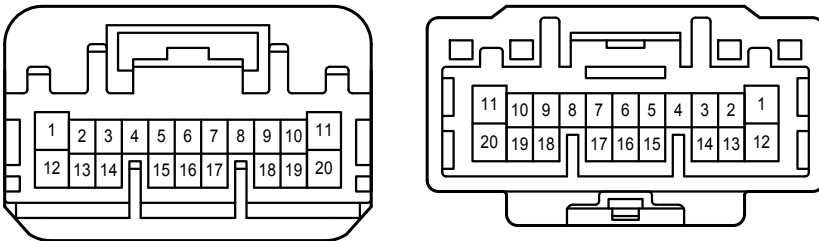

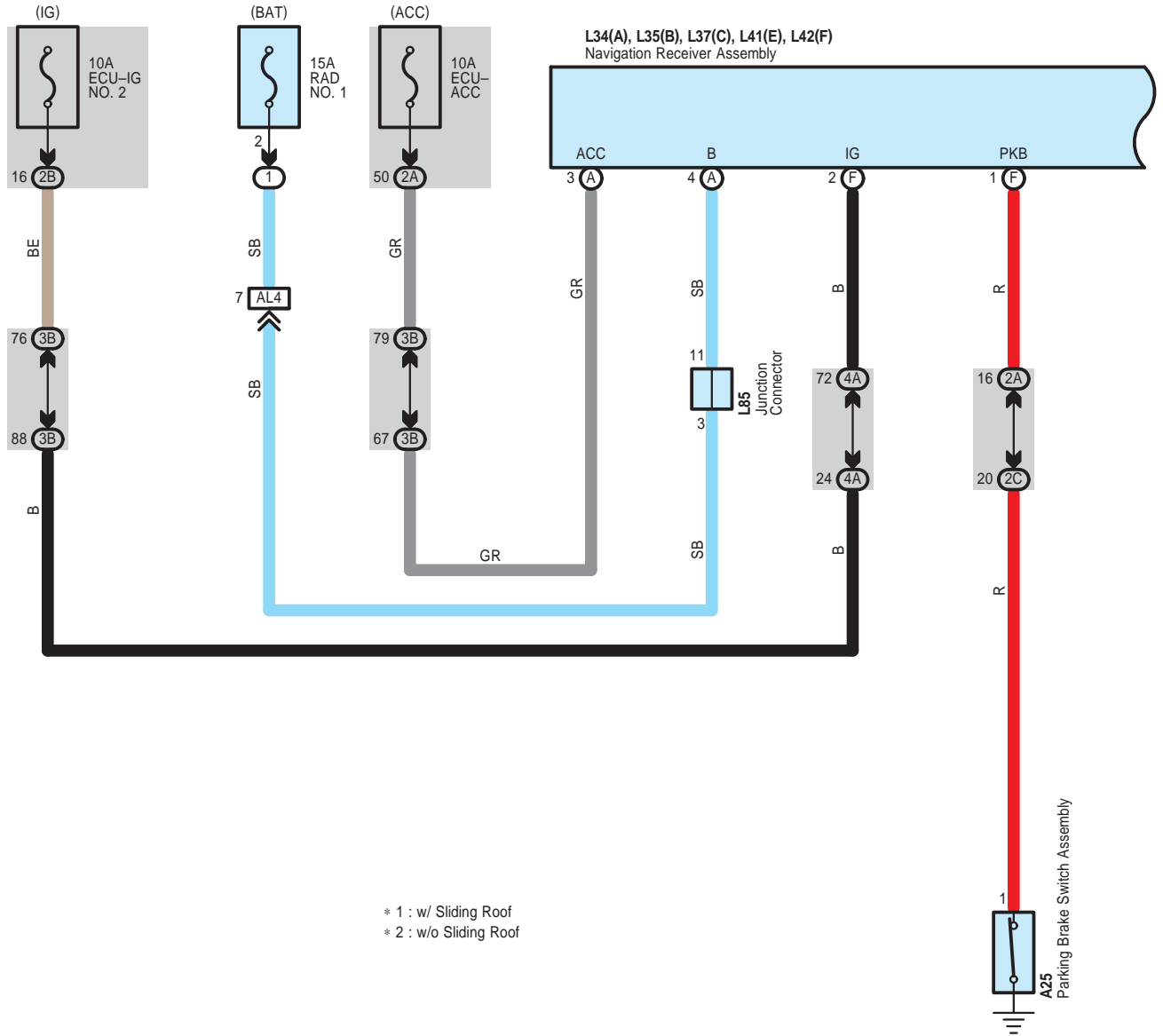

L34(A), L35(B), L37(C), L41(E), L42(F)  
Navigation Receiver Assembly

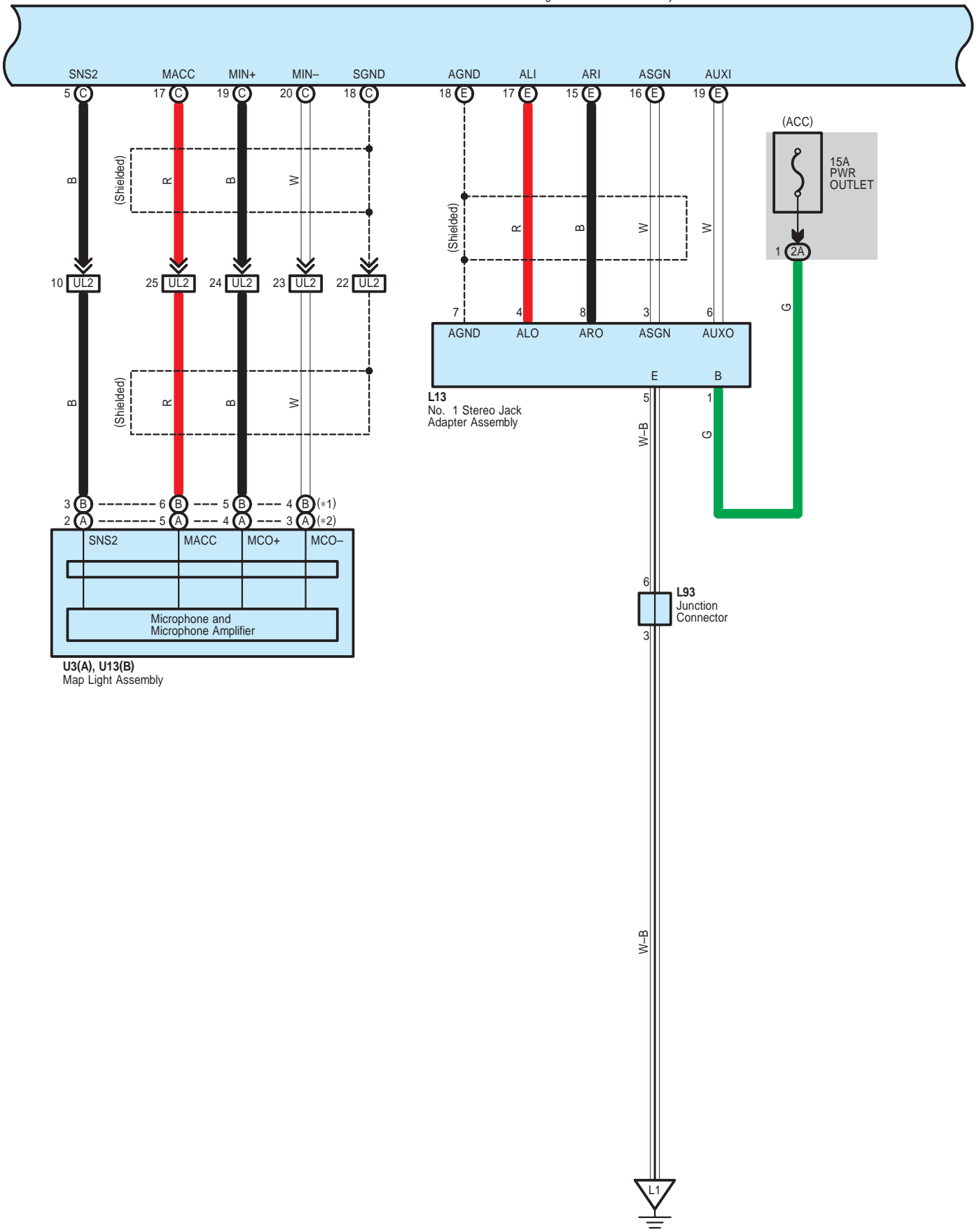

U3(A), U13(B)  
Map Light Assembly

L13  
No. 1 Stereo Jack  
Adapter Assembly

L93  
Junction  
Connector

L34(A), L35(B), L37(C), L41(E), L42(F)  
Navigation Receiver Assembly

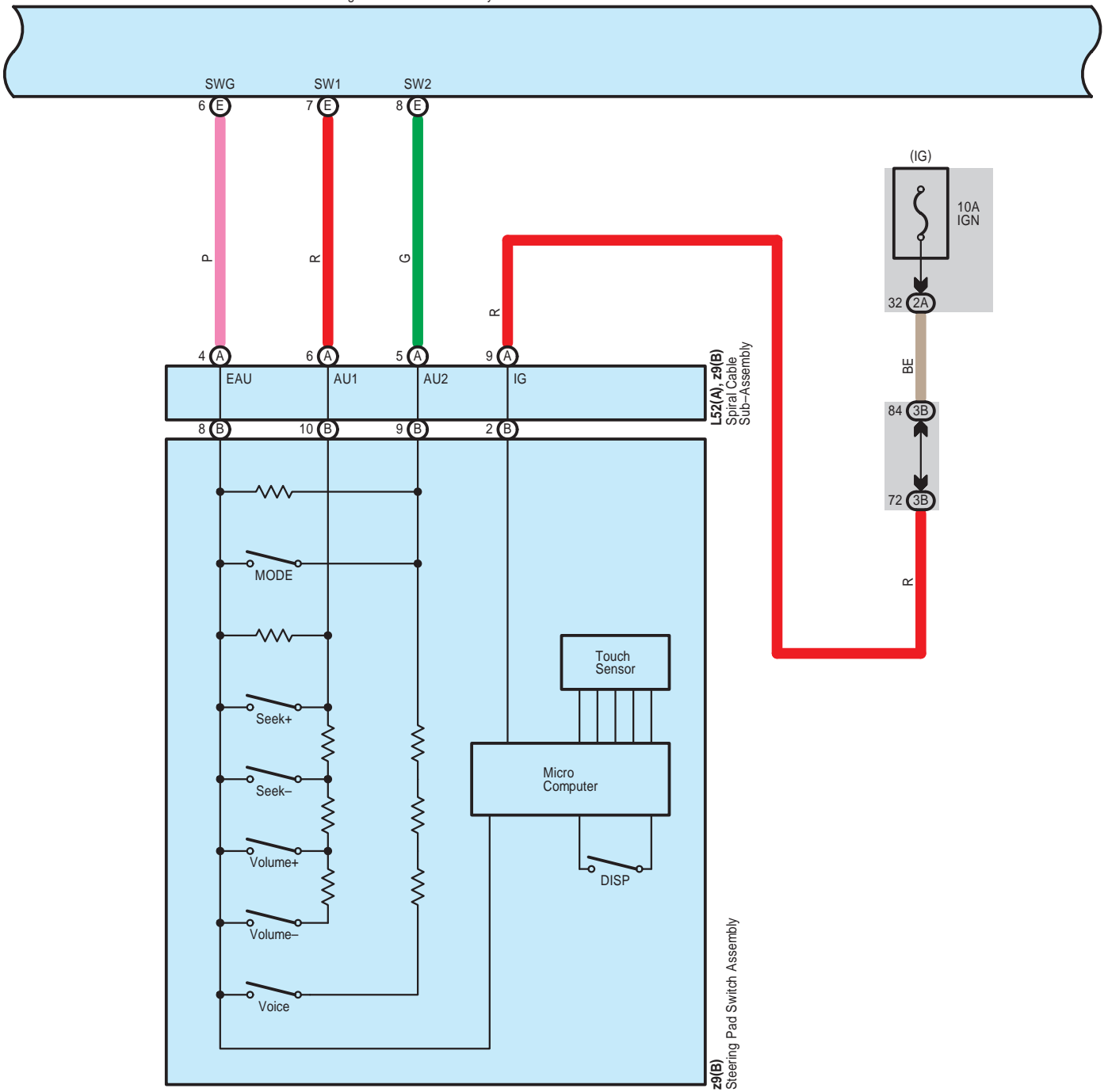

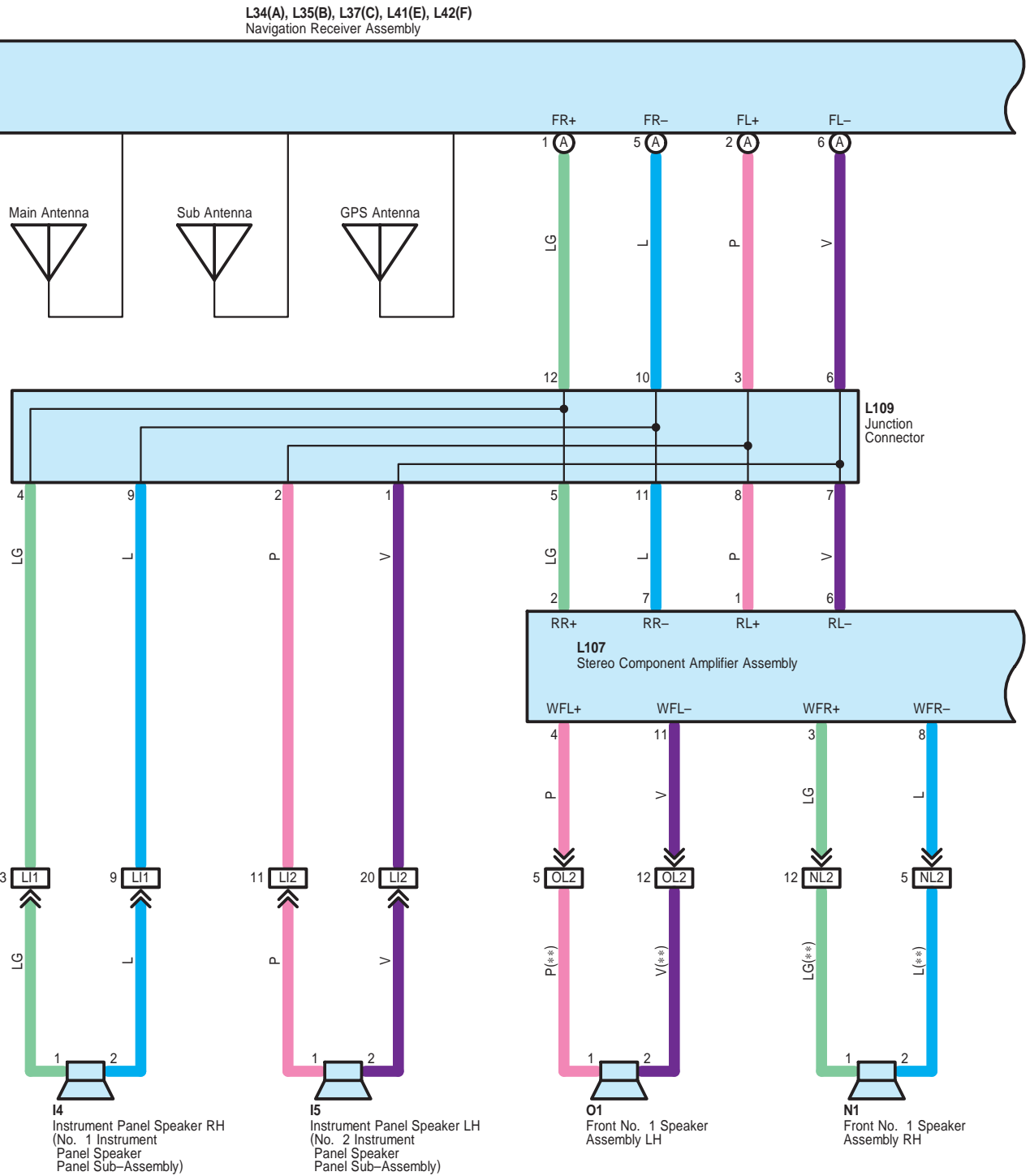

When wiring colors are indicated with (\*\*), either the colored wiring (general wiring) or the painted wiring is used.

L34(A), L35(B), L37(C), L41(E), L42(F)  
Navigation Receiver Assembly

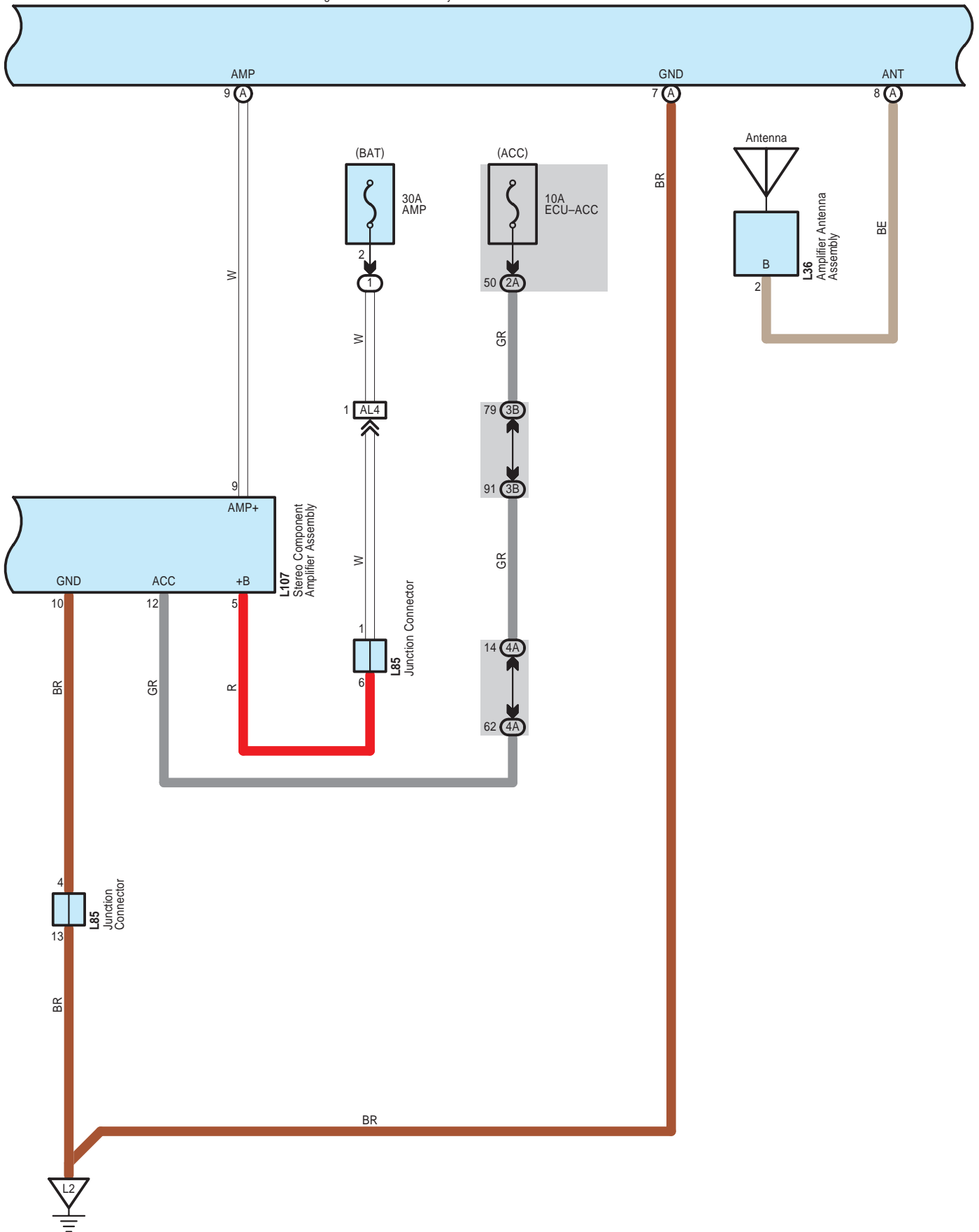



L34(A), L35(B), L37(C), L41(E), L42(F)  
Navigation Receiver Assembly

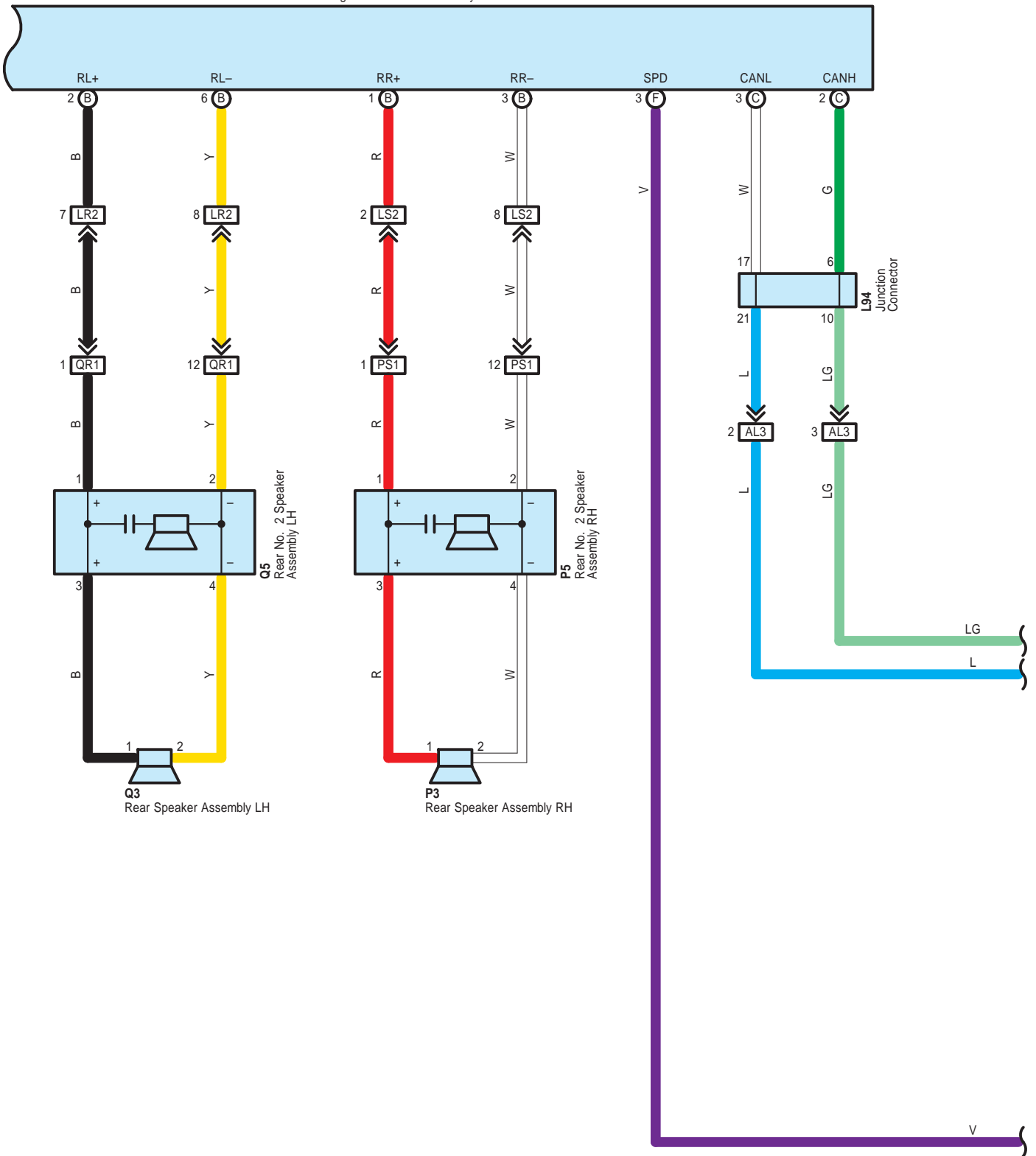

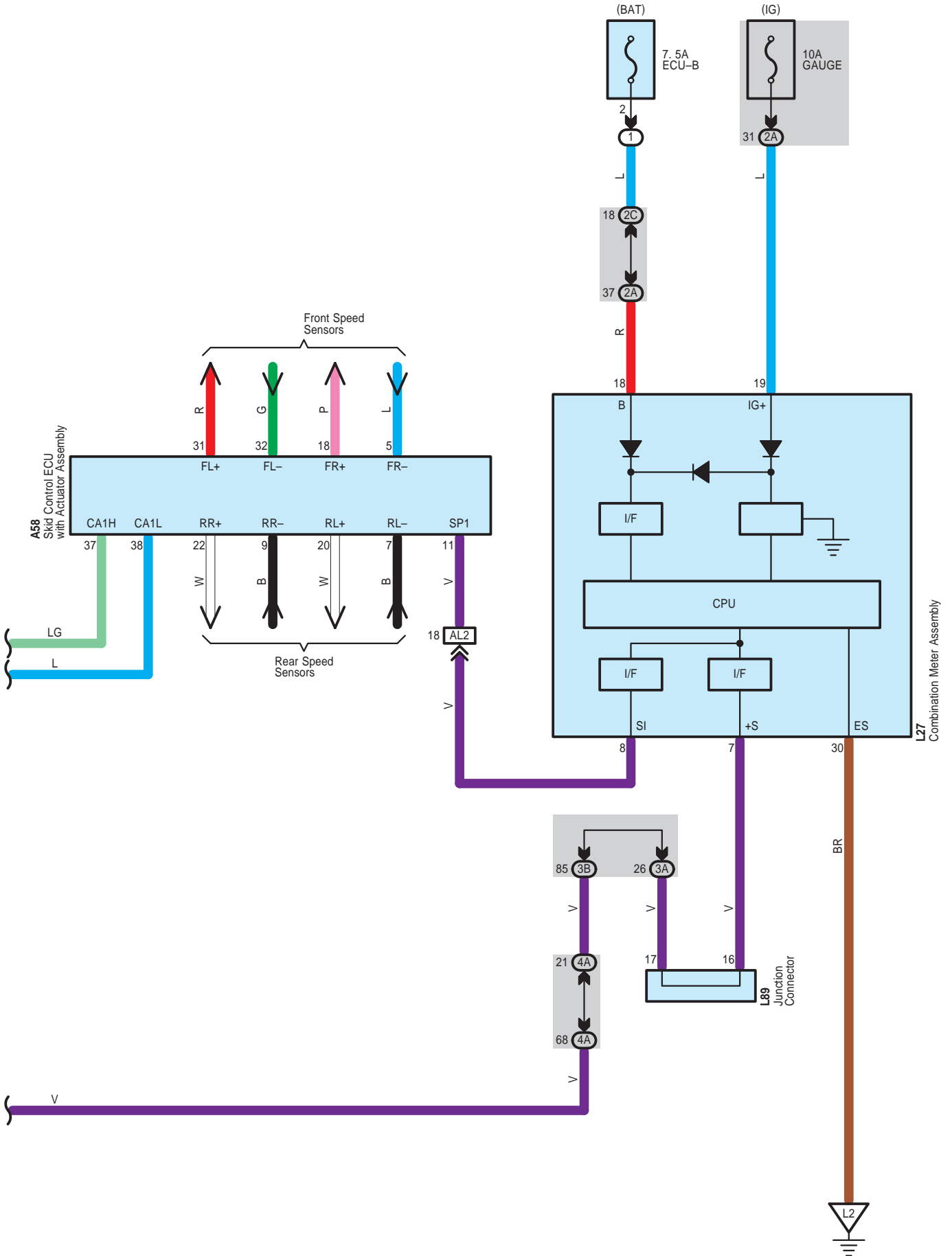

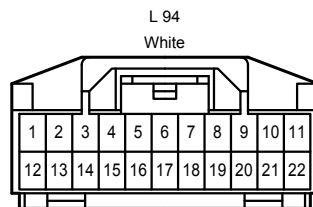
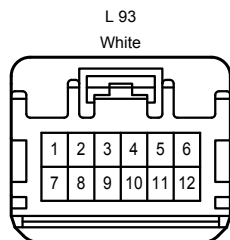
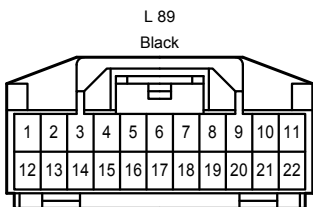
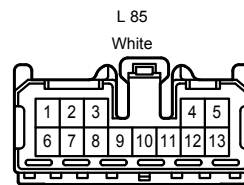
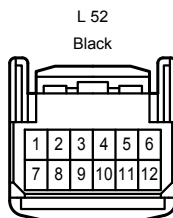
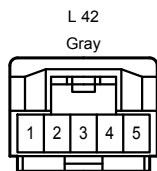
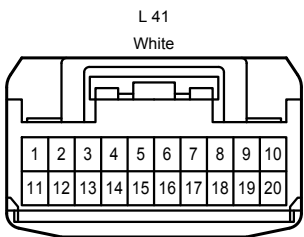
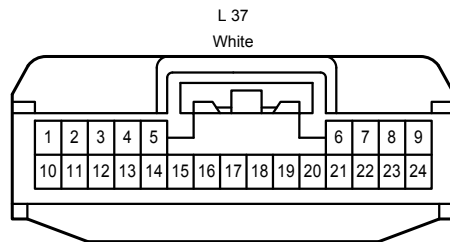
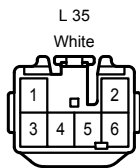
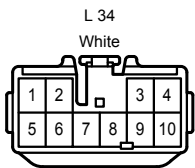
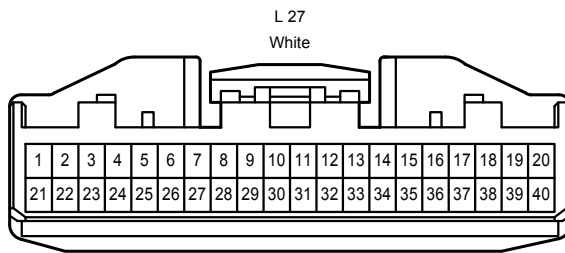
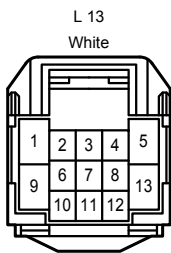
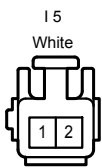
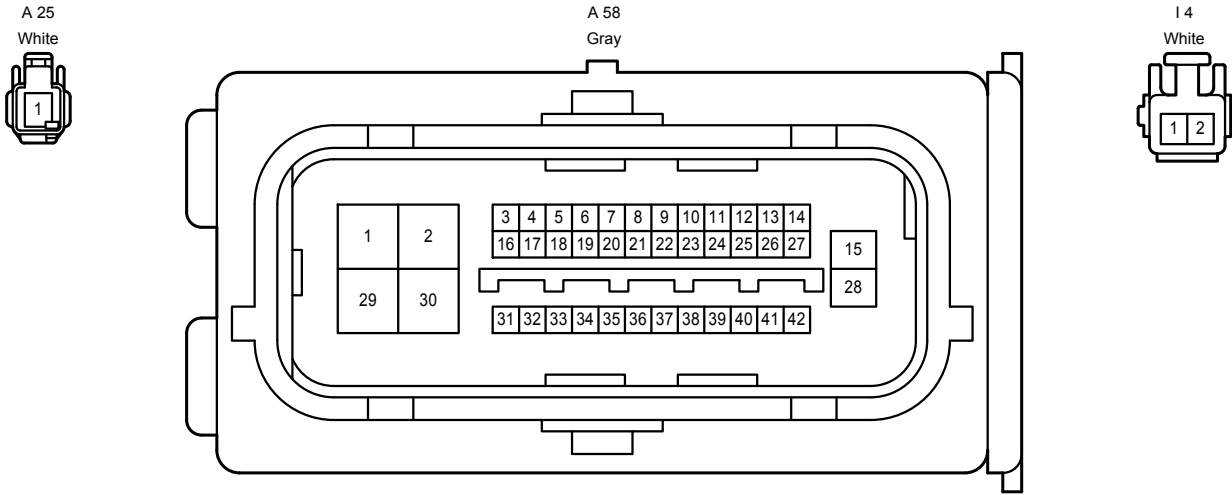

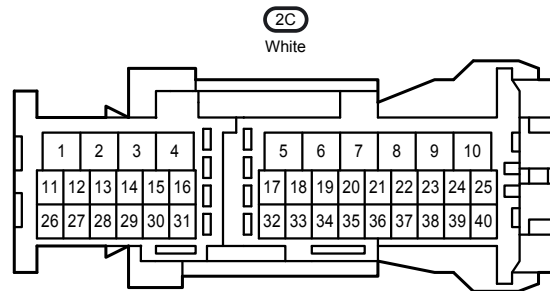
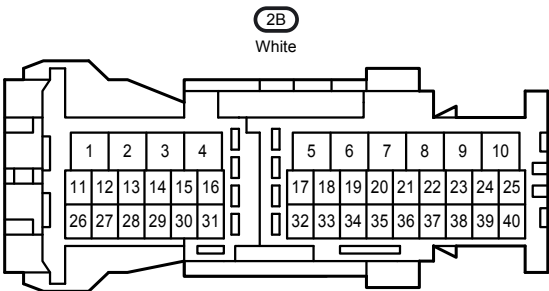
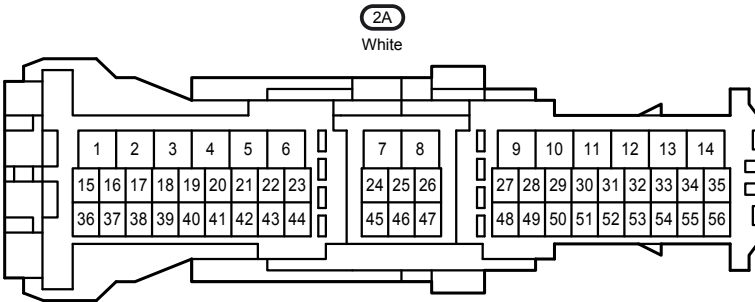
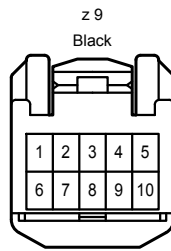
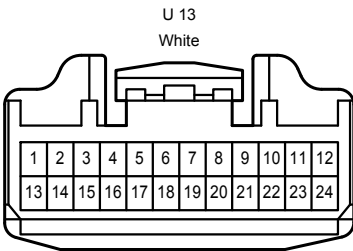
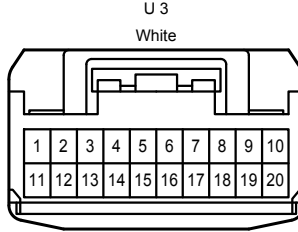
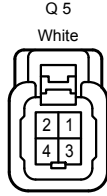
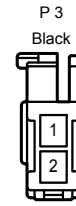
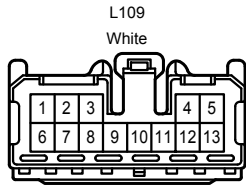
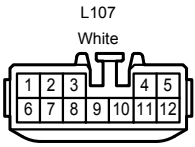

3A  
White

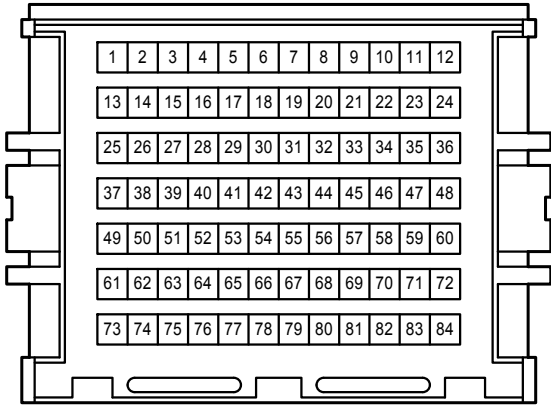

3B  
White

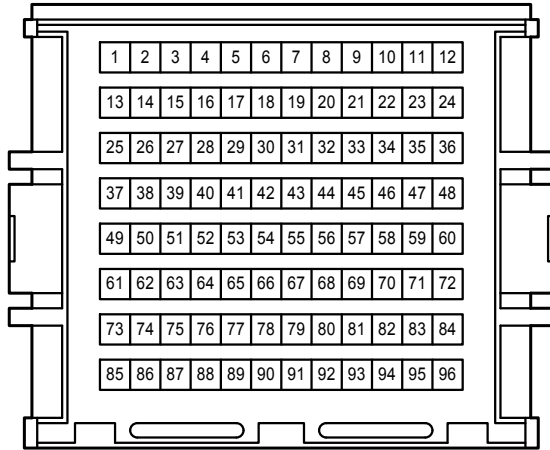

4A  
White

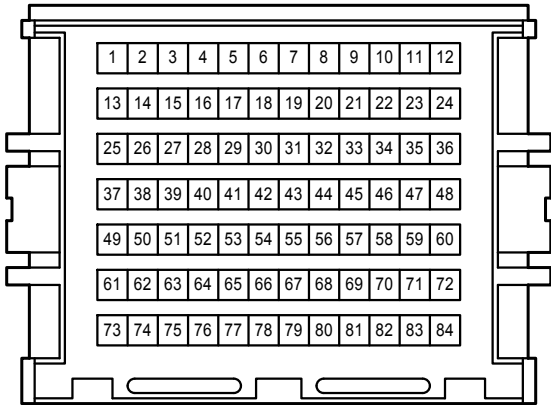

AL2  
Gray

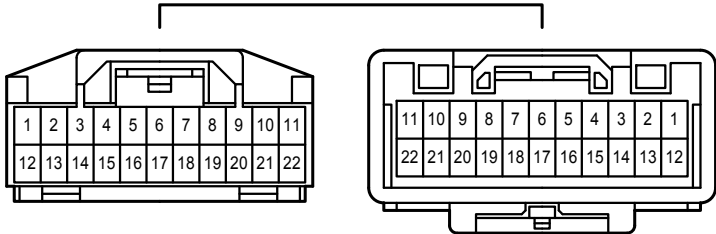

AL3  
White

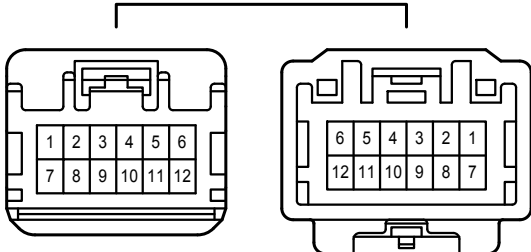

AL4  
Black

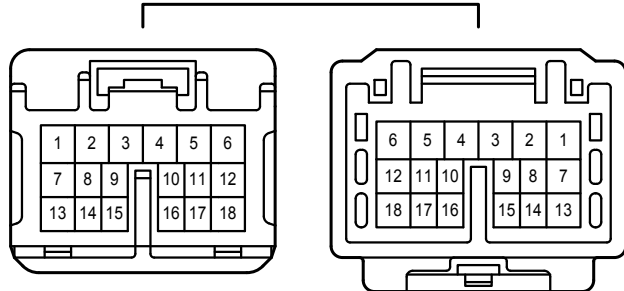

L11  
Black

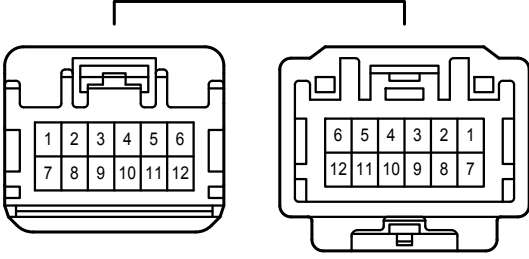

L12  
White

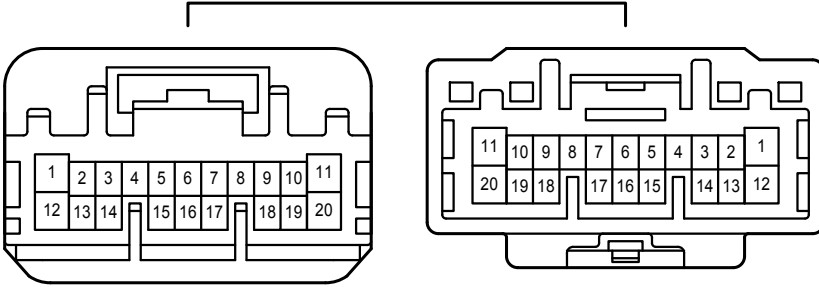

LR2  
Black

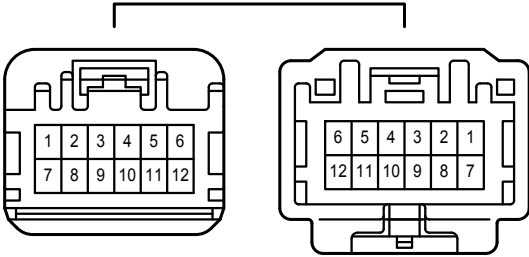

LS2  
Black

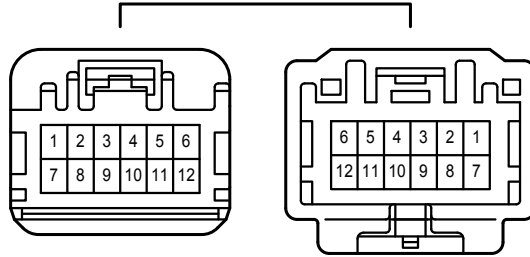

NL2  
White

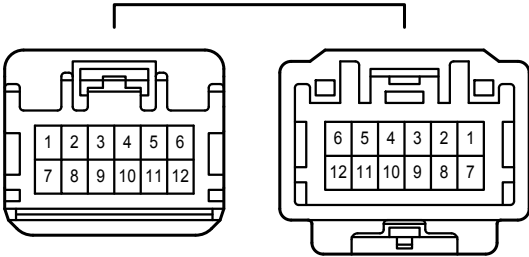

OL2  
White

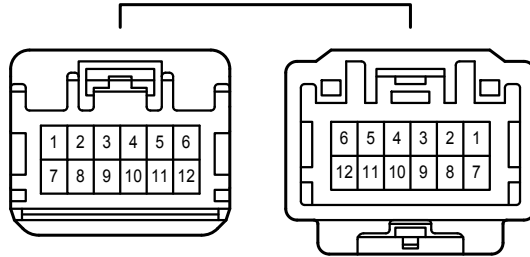

PS1  
White

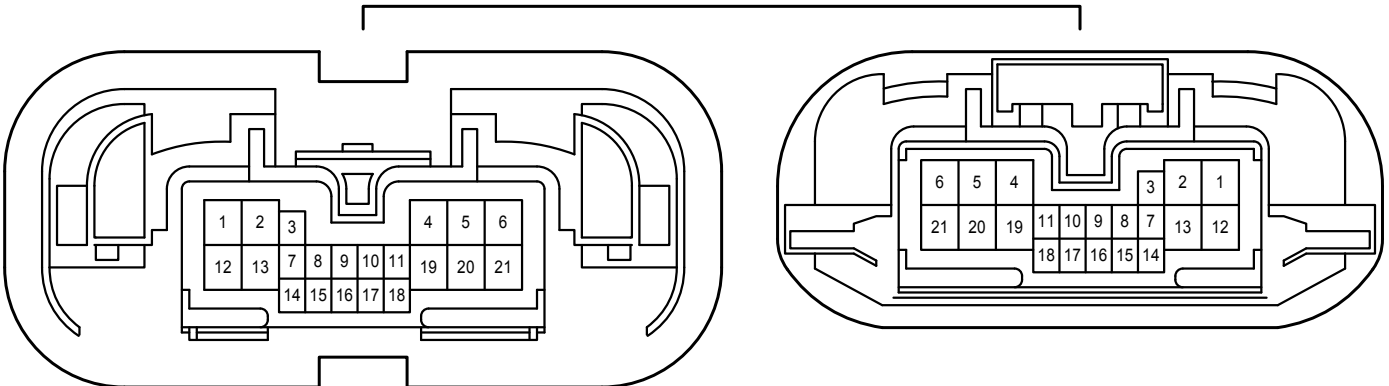

QR1  
White

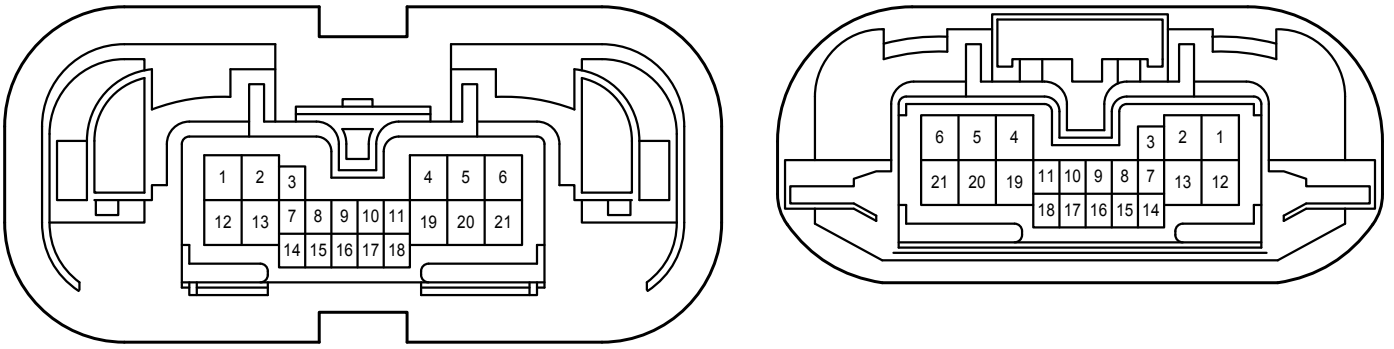

UL2  
White

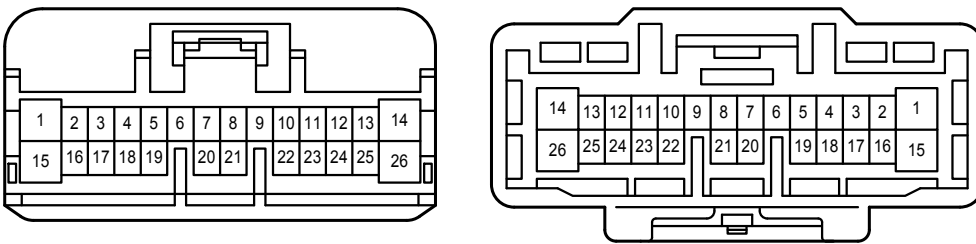

Audio System <w/o Stereo Component Amplifier>

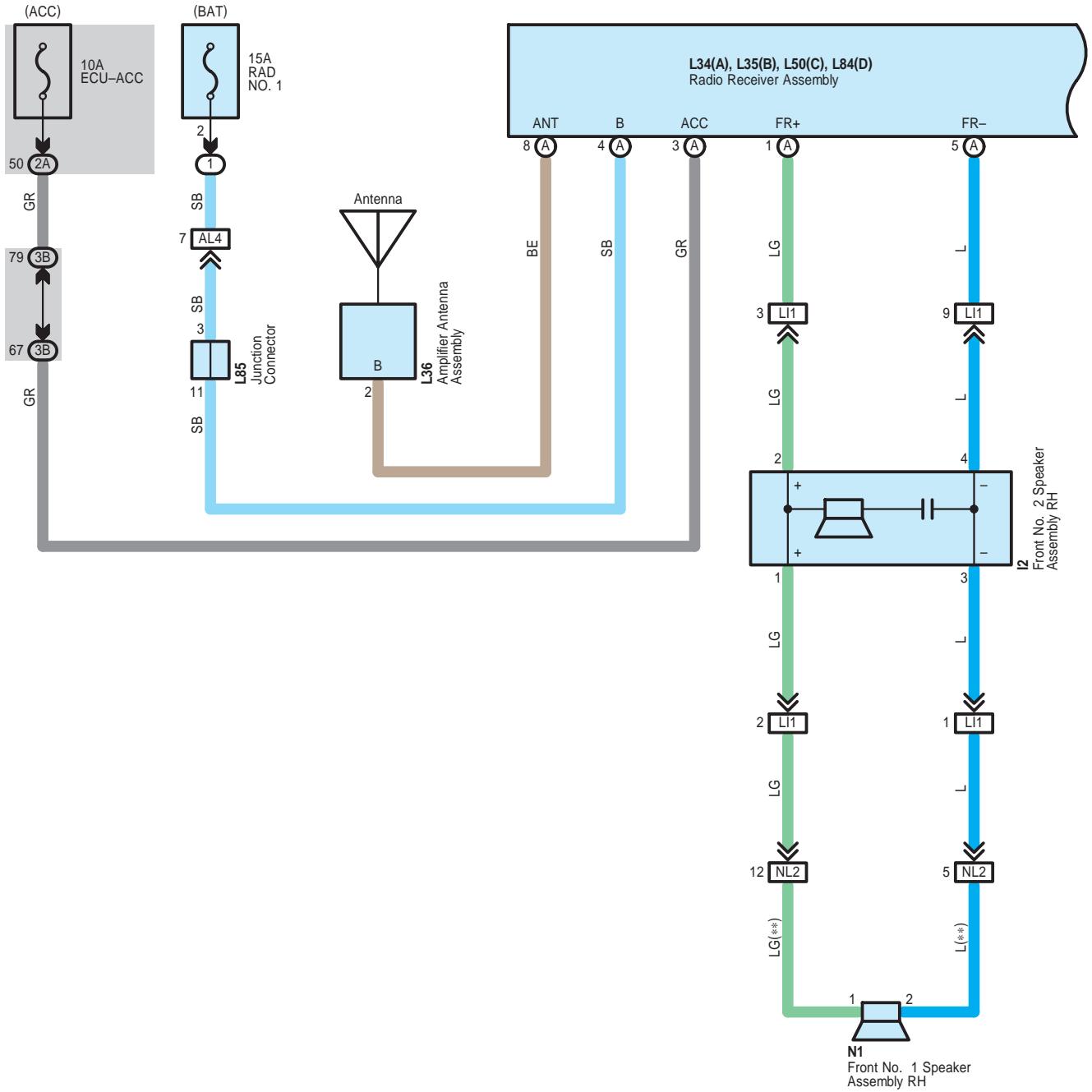



Audio System <w/o Stereo Component Amplifier>

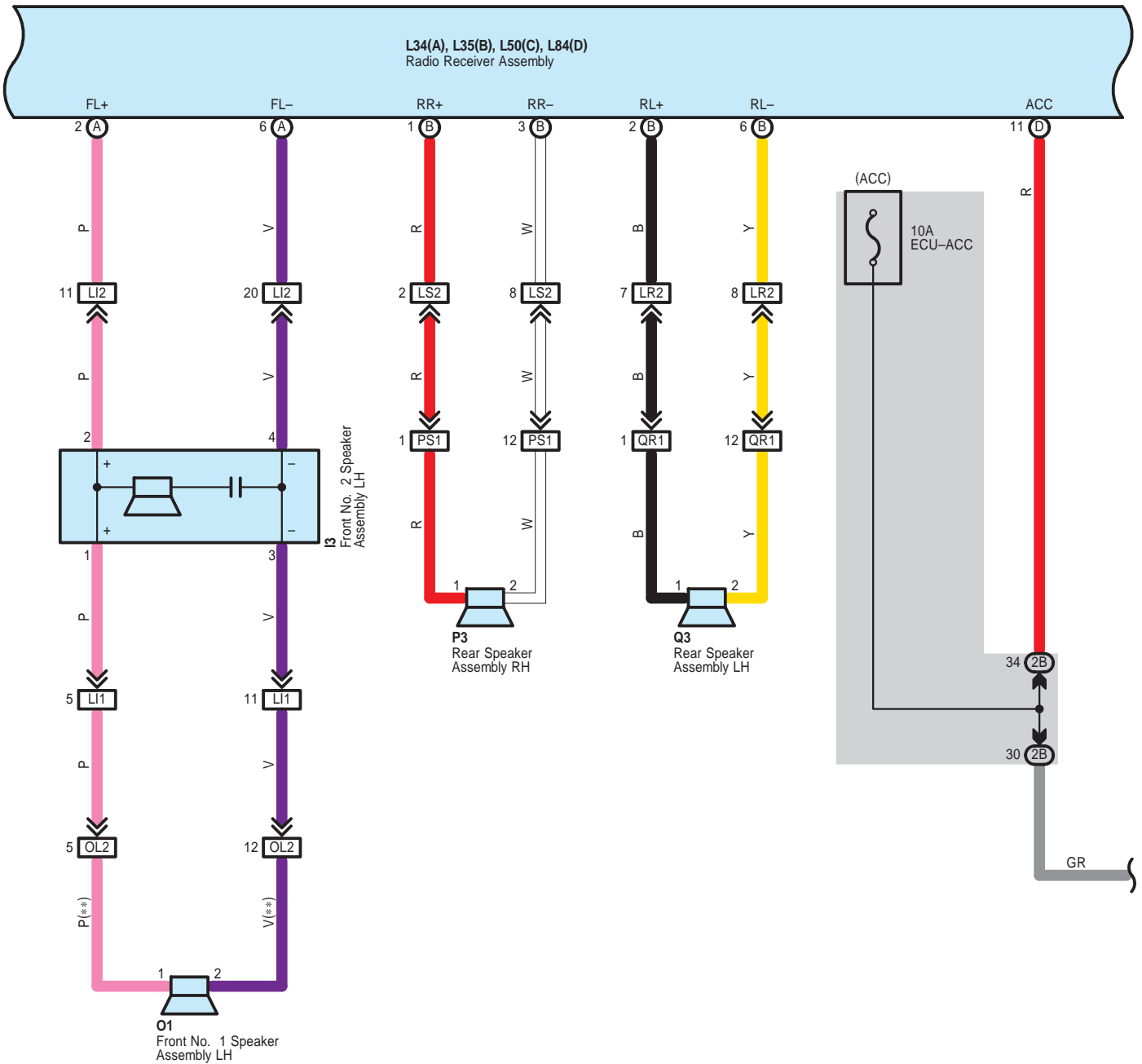

When wiring colors are indicated with (\*\*), either the colored wiring (general wiring) or the painted wiring is used.

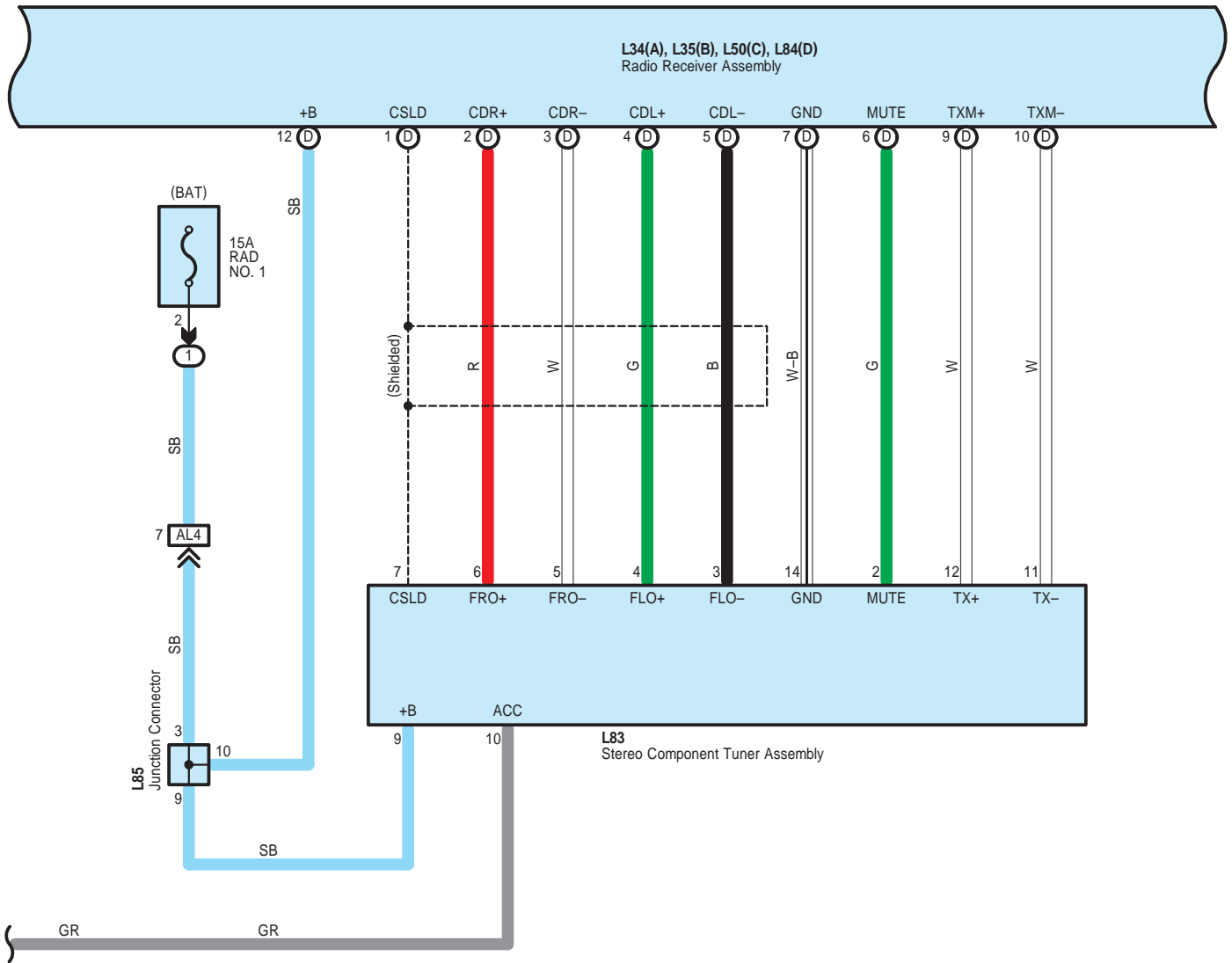

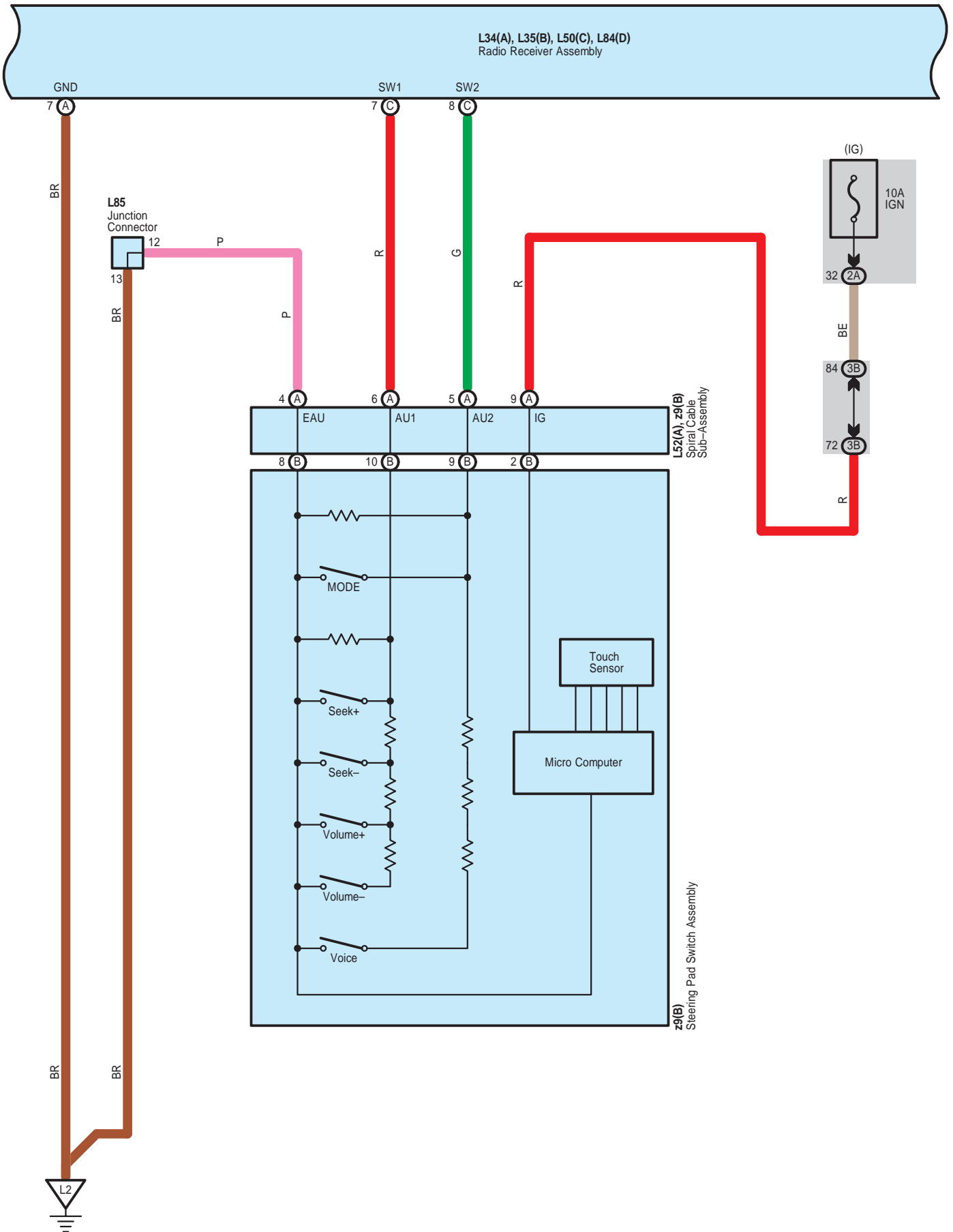

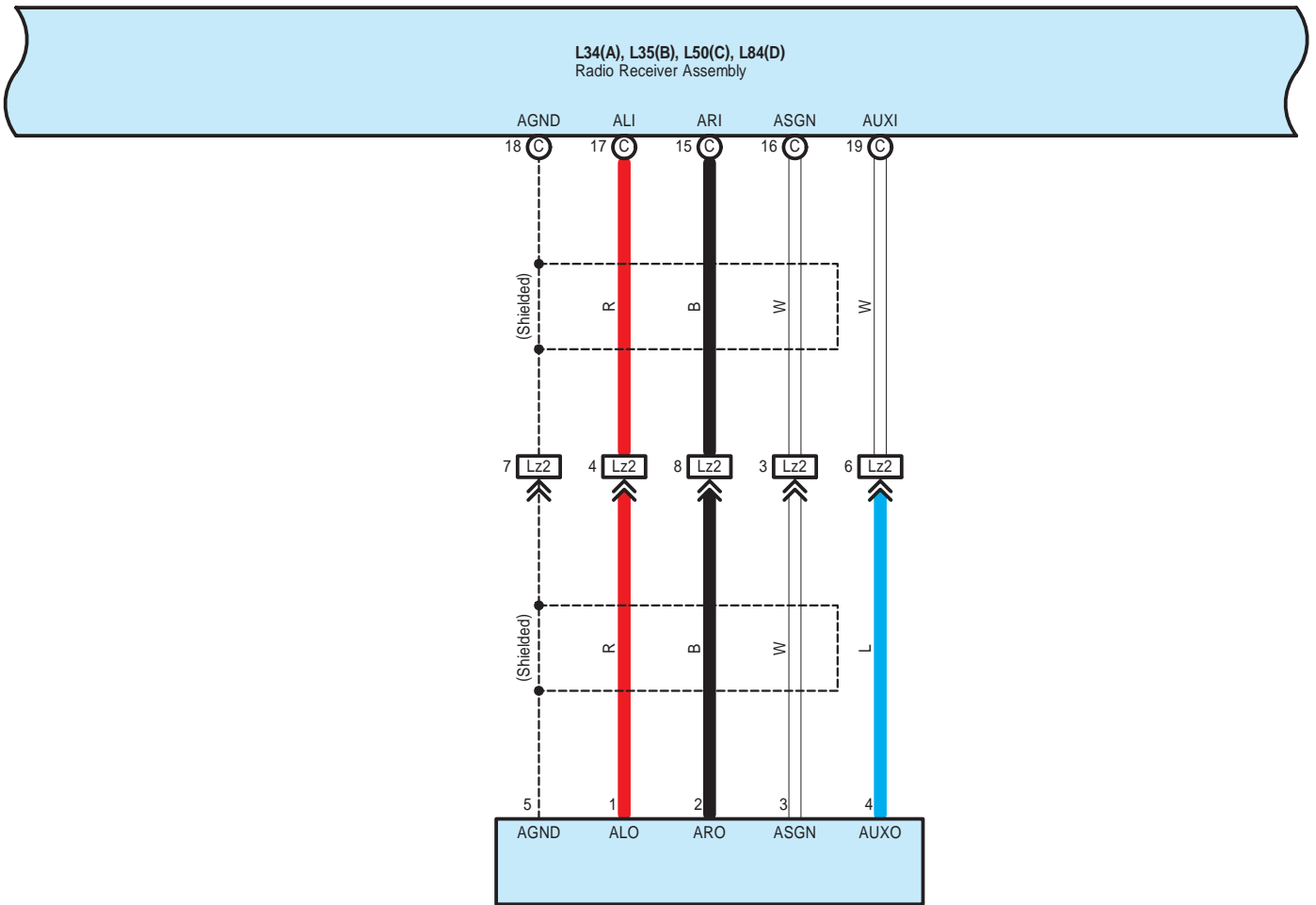

z19  
No. 1 Stereo Jack  
Adapter Assembly

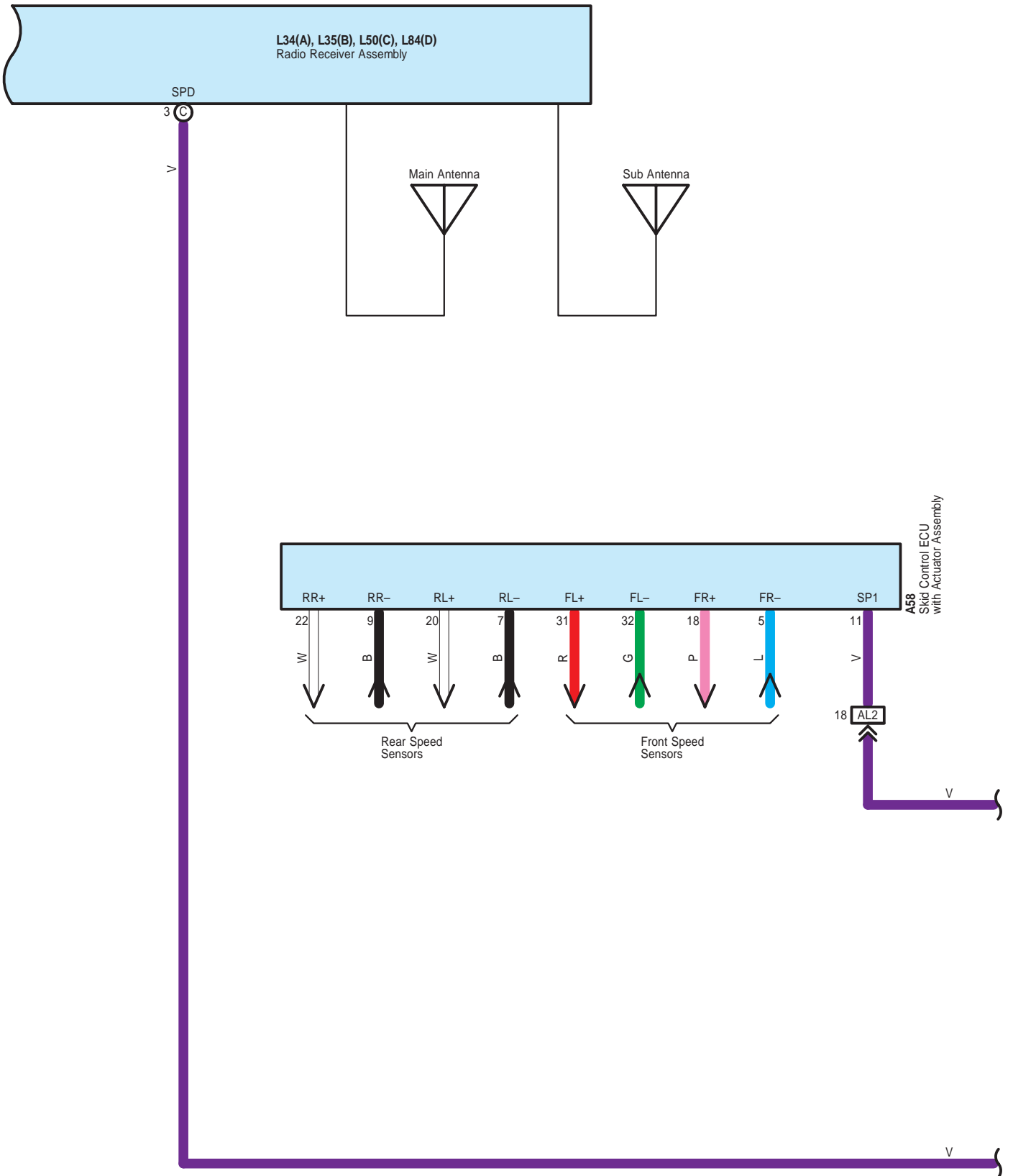

Audio System <w/o Stereo Component Amplifier>

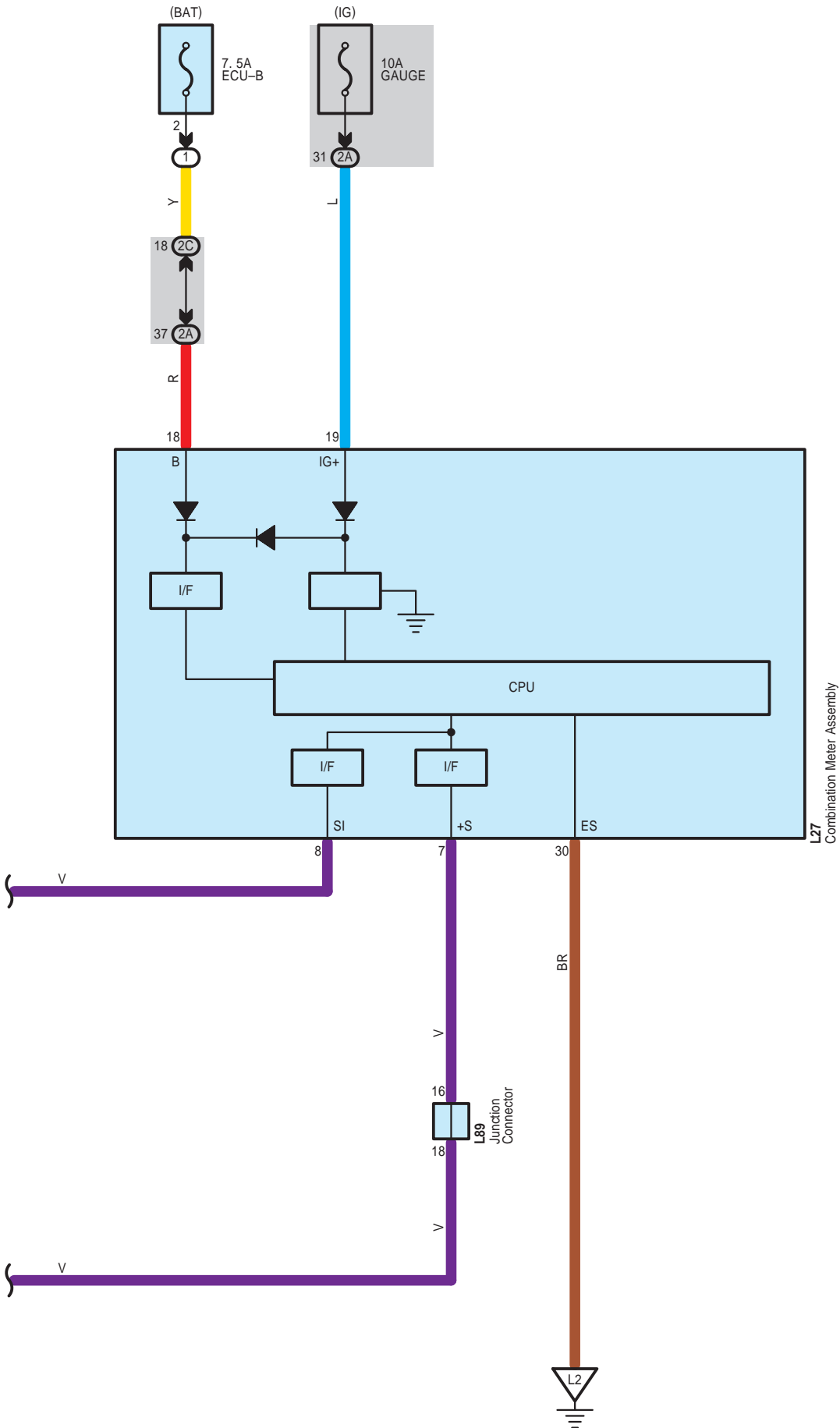

Audio System <w/o Stereo Component Amplifier>

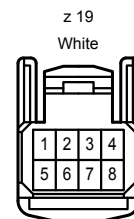
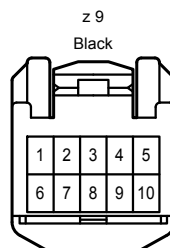
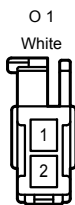
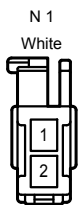
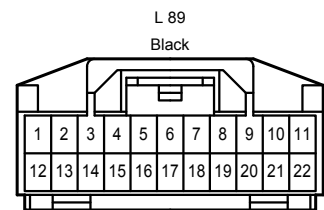
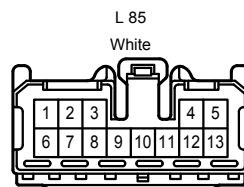
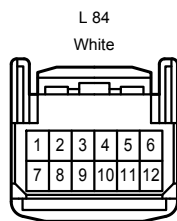
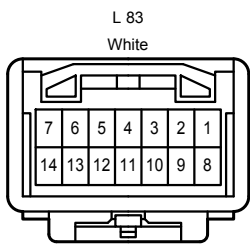
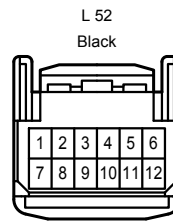
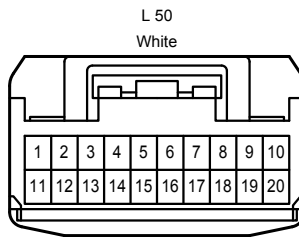
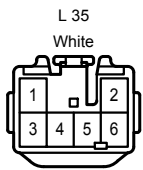
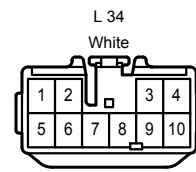
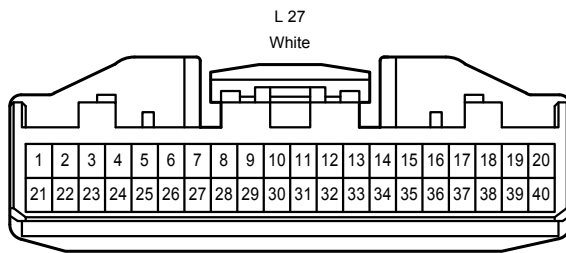
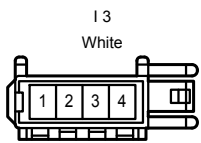
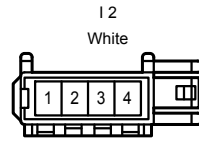
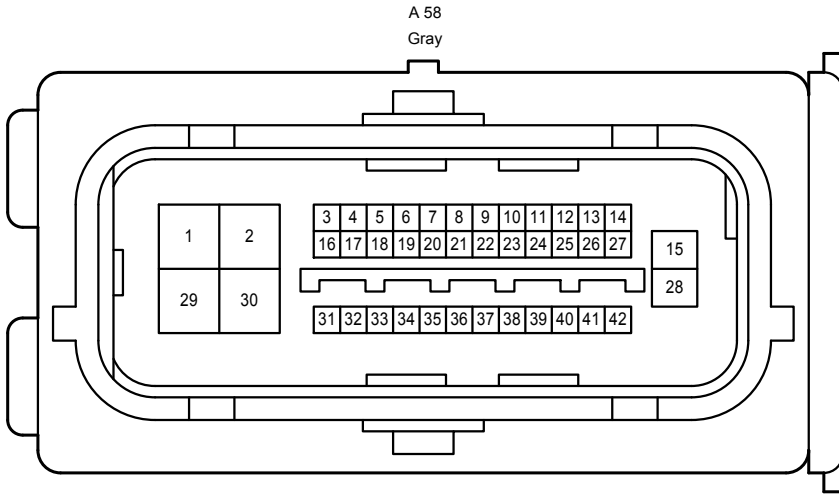

2A

White

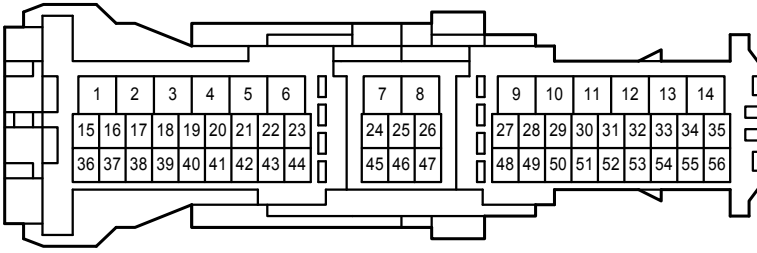

2B

White

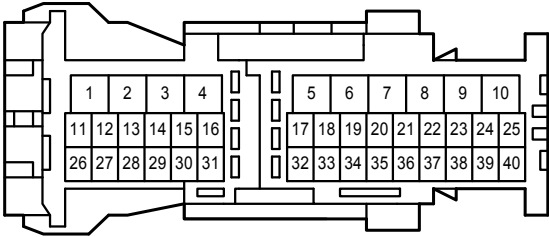

2C

White

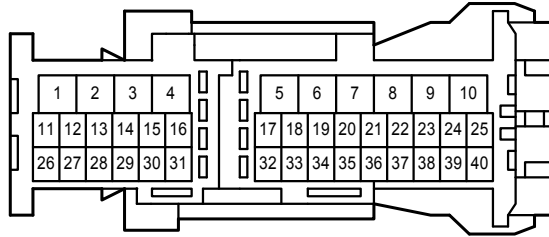

3B

White

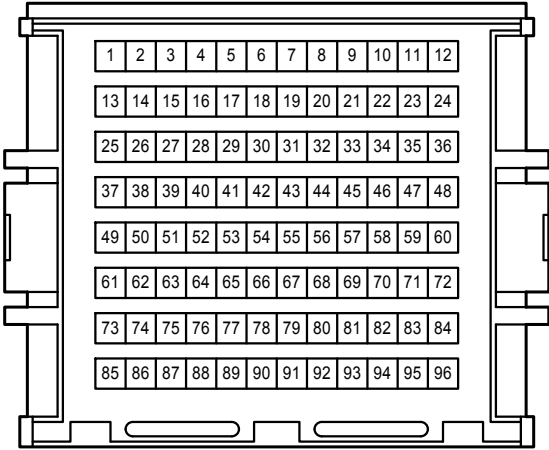

AL2

Gray

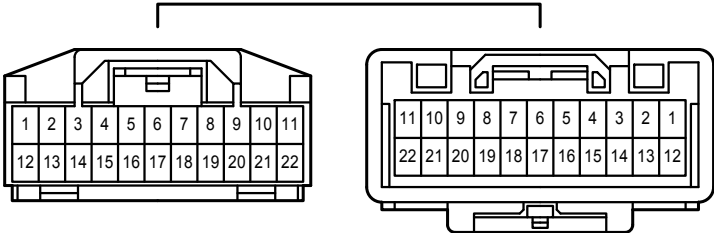



Audio System <w/o Stereo Component Amplifier>

AL4  
Black

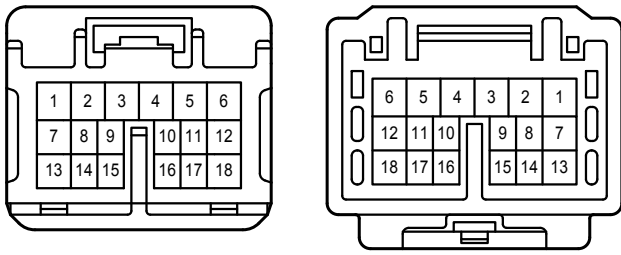

L11  
Black

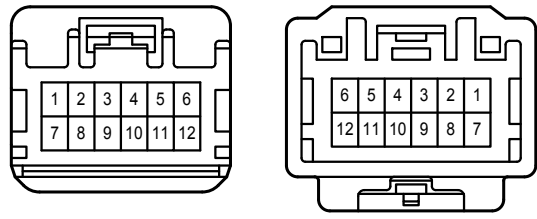

L12  
White

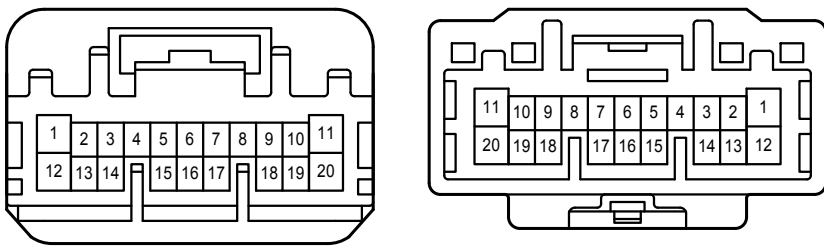

LR2  
Black

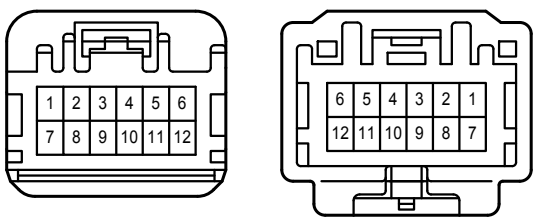

LS2  
Black

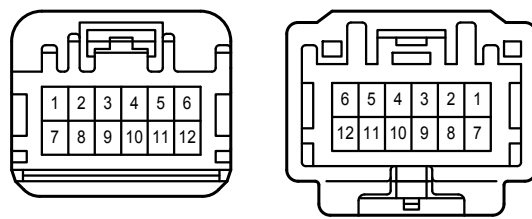

Lz2  
White

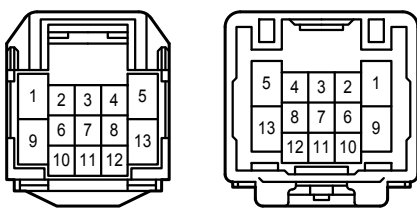

NL2  
White

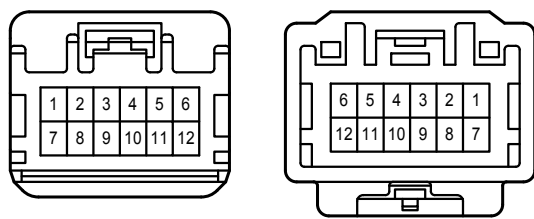

OL2  
White

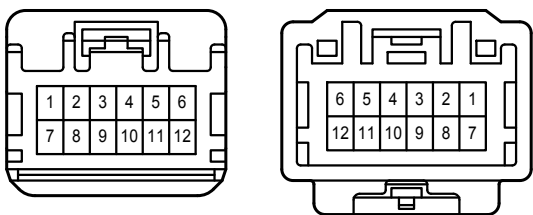

Audio System <w/o Stereo Component Amplifier>

PS1  
White

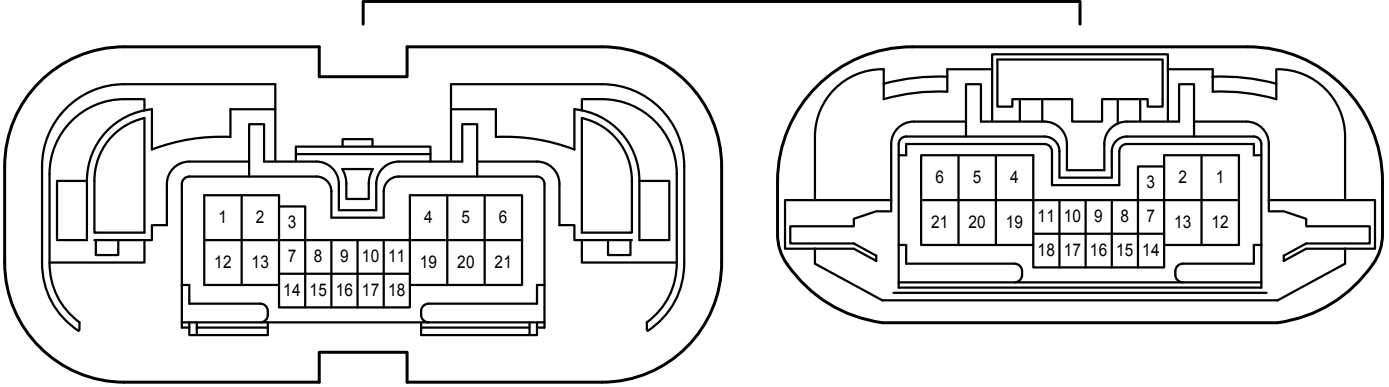

QR1  
White

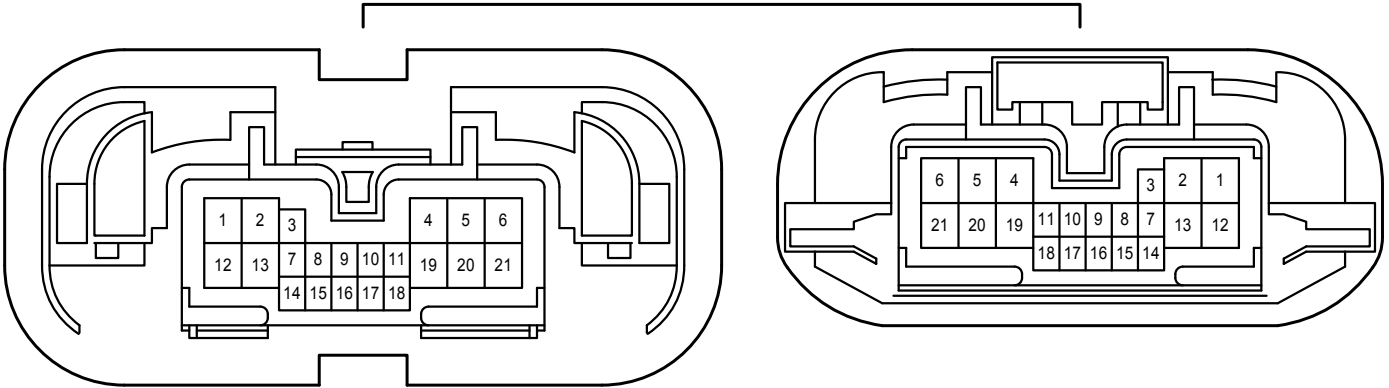

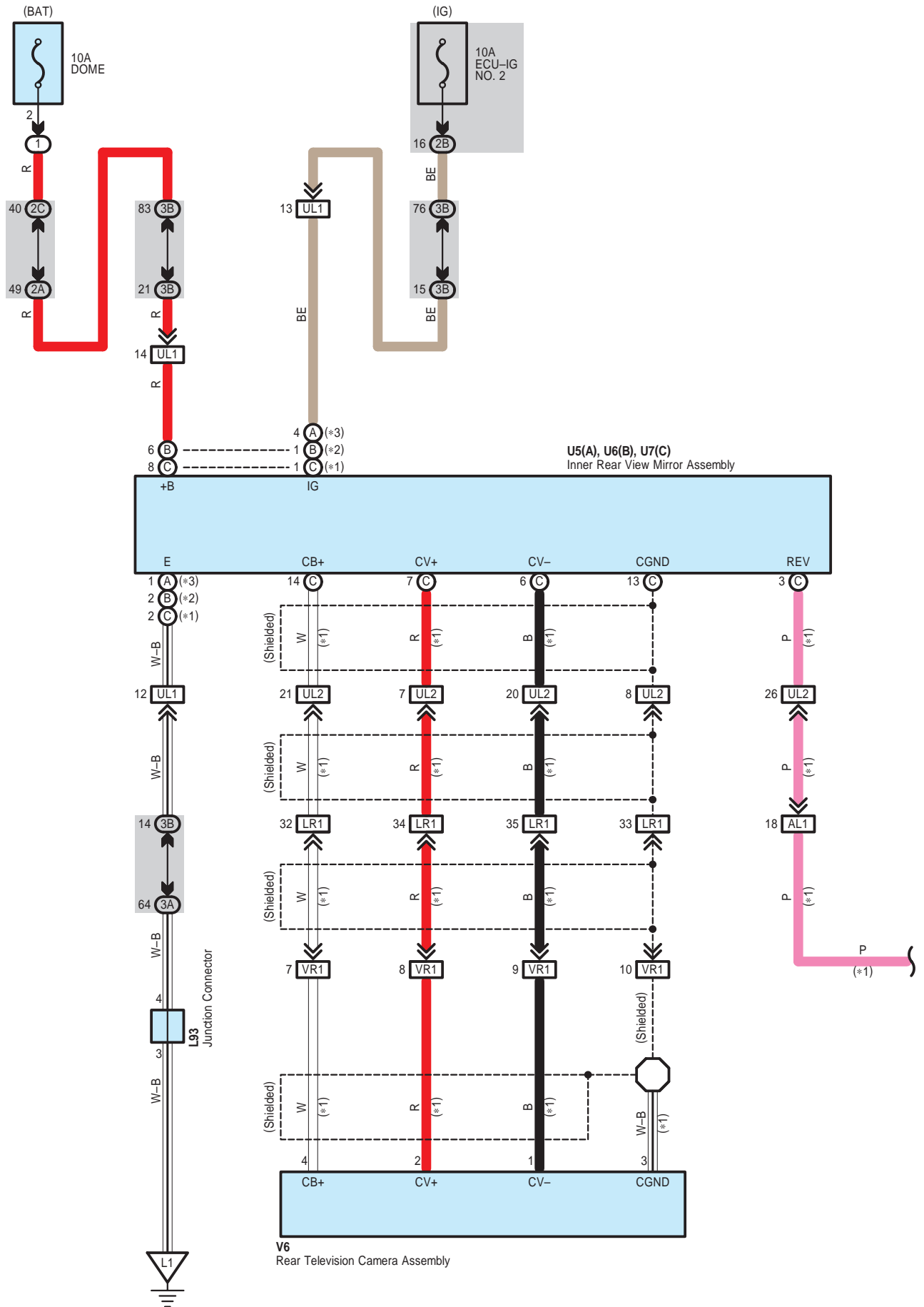



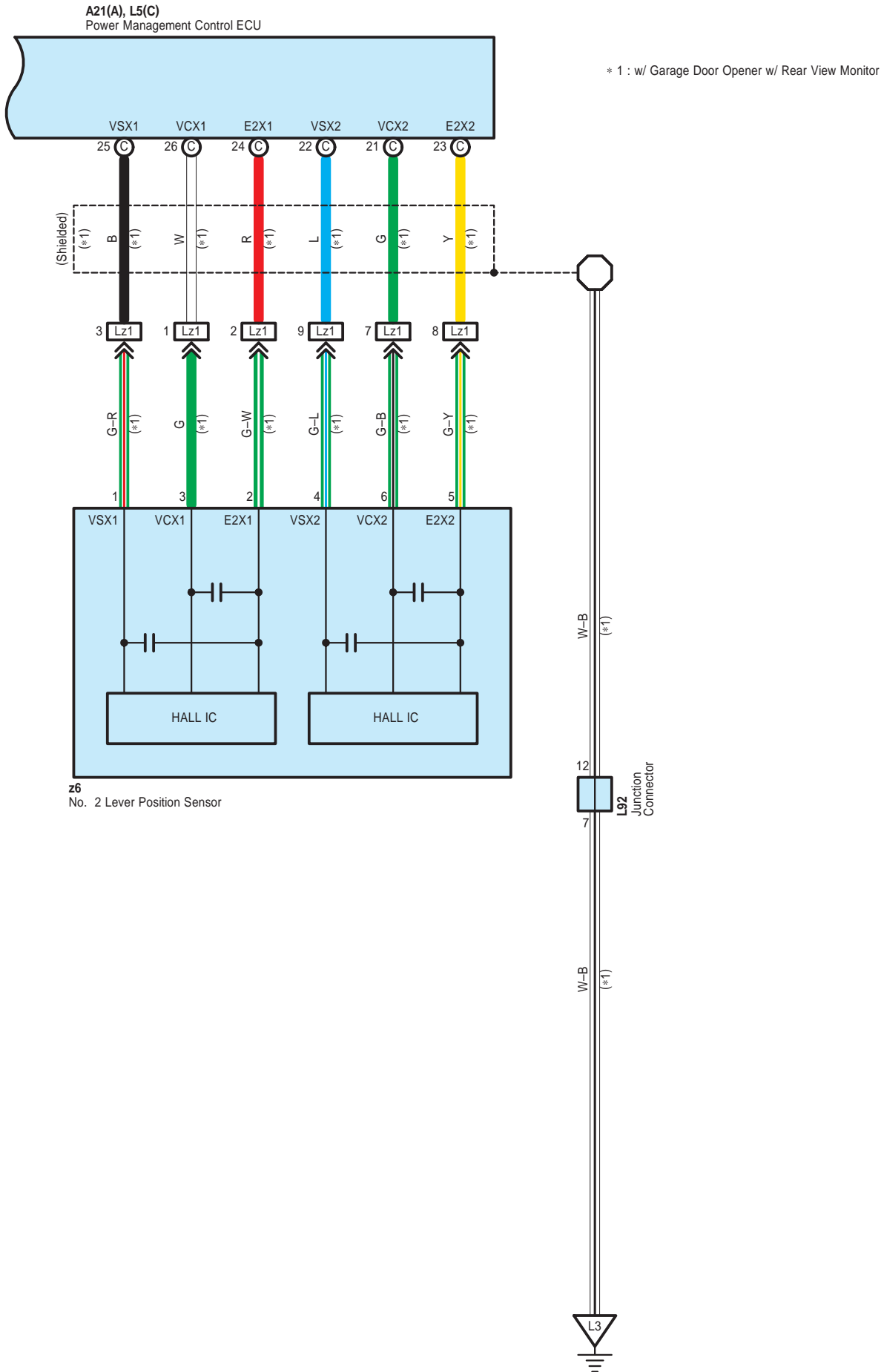

A 21  
Gray

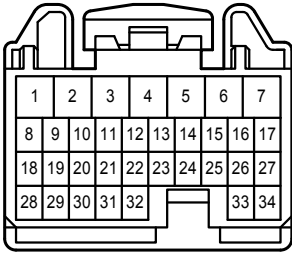

L 5  
Gray

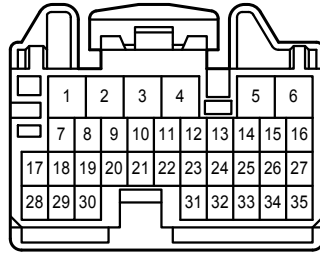

L 92  
White

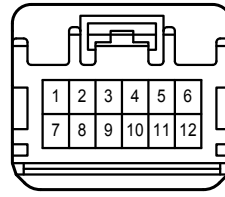

L 93  
White

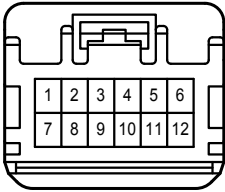

U 5  
White

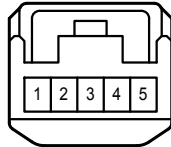

U 6  
White

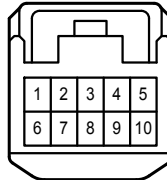

U 7  
White

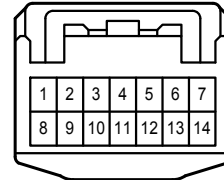

V 6  
Black

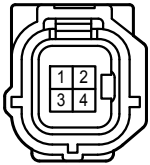

z 5  
White

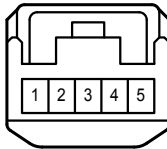

z 6  
White

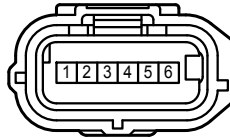

1G  
White

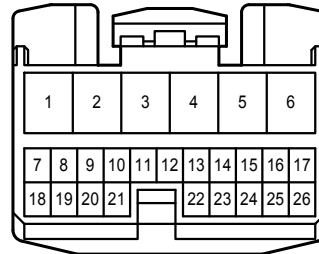

1H  
White

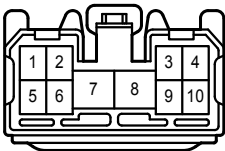

2A  
White

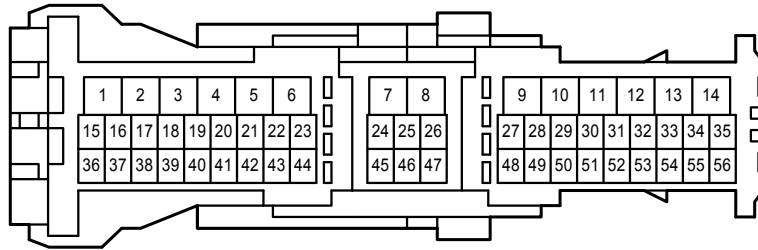

2B  
White

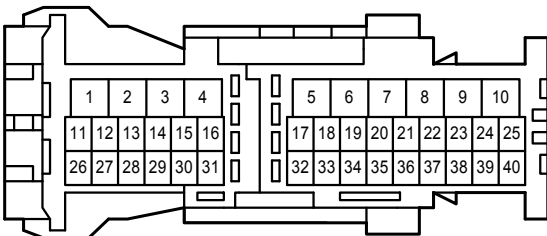

2C  
White

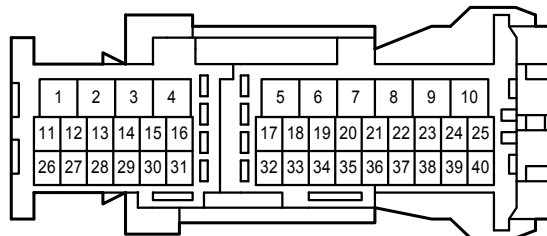

3A  
White

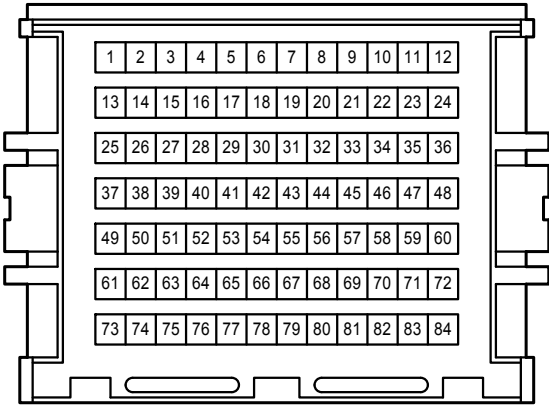

3B  
White

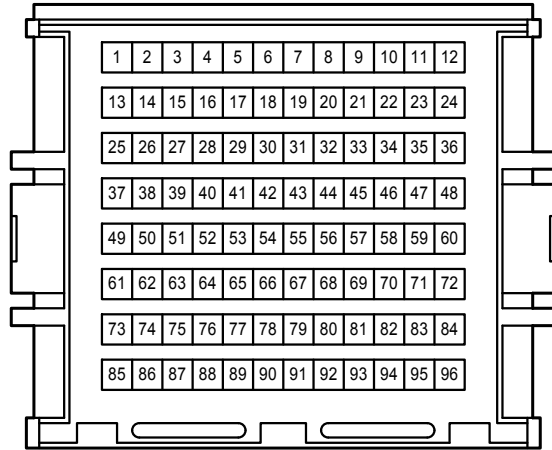

AL1  
Blue

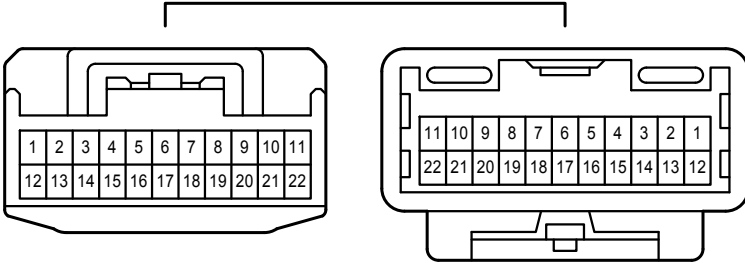

LR1  
White

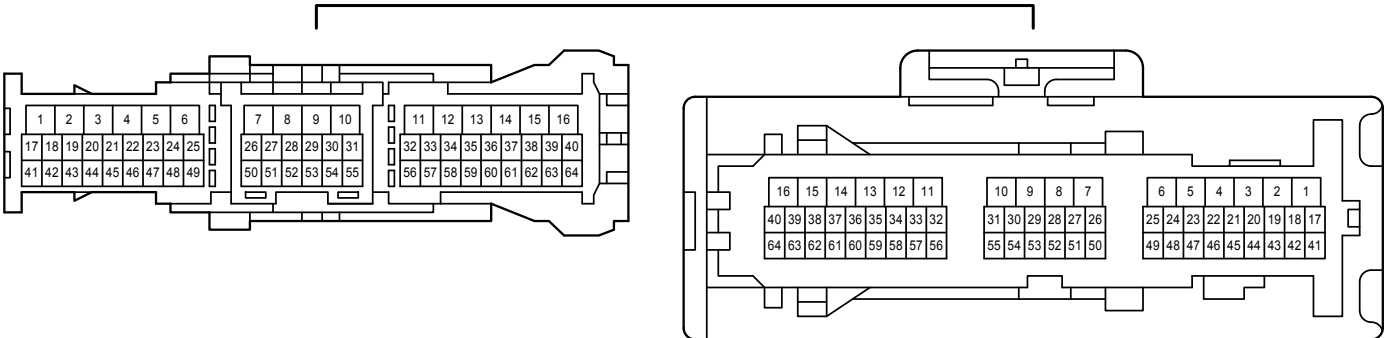

Lz1  
White

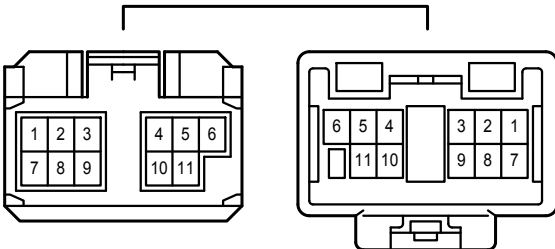

UL1  
Gray

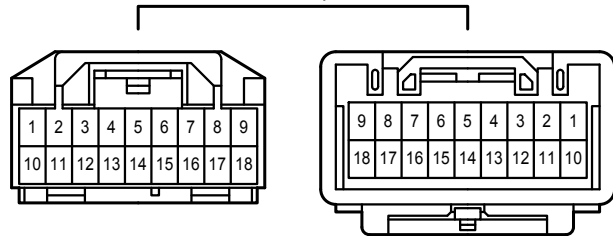

UL2  
White

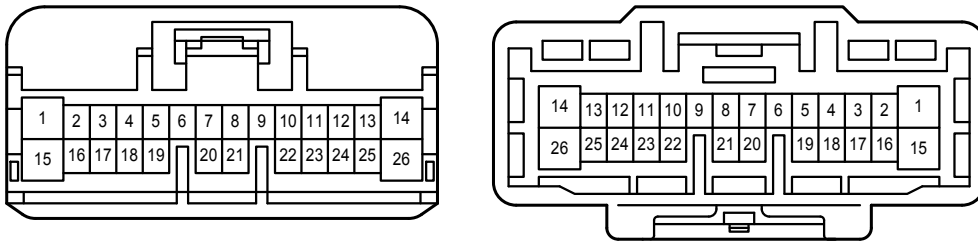

VR1  
White

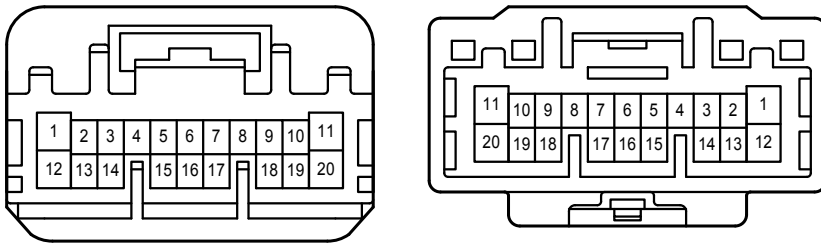



Automatic Light Control , Light Auto Turn Off System

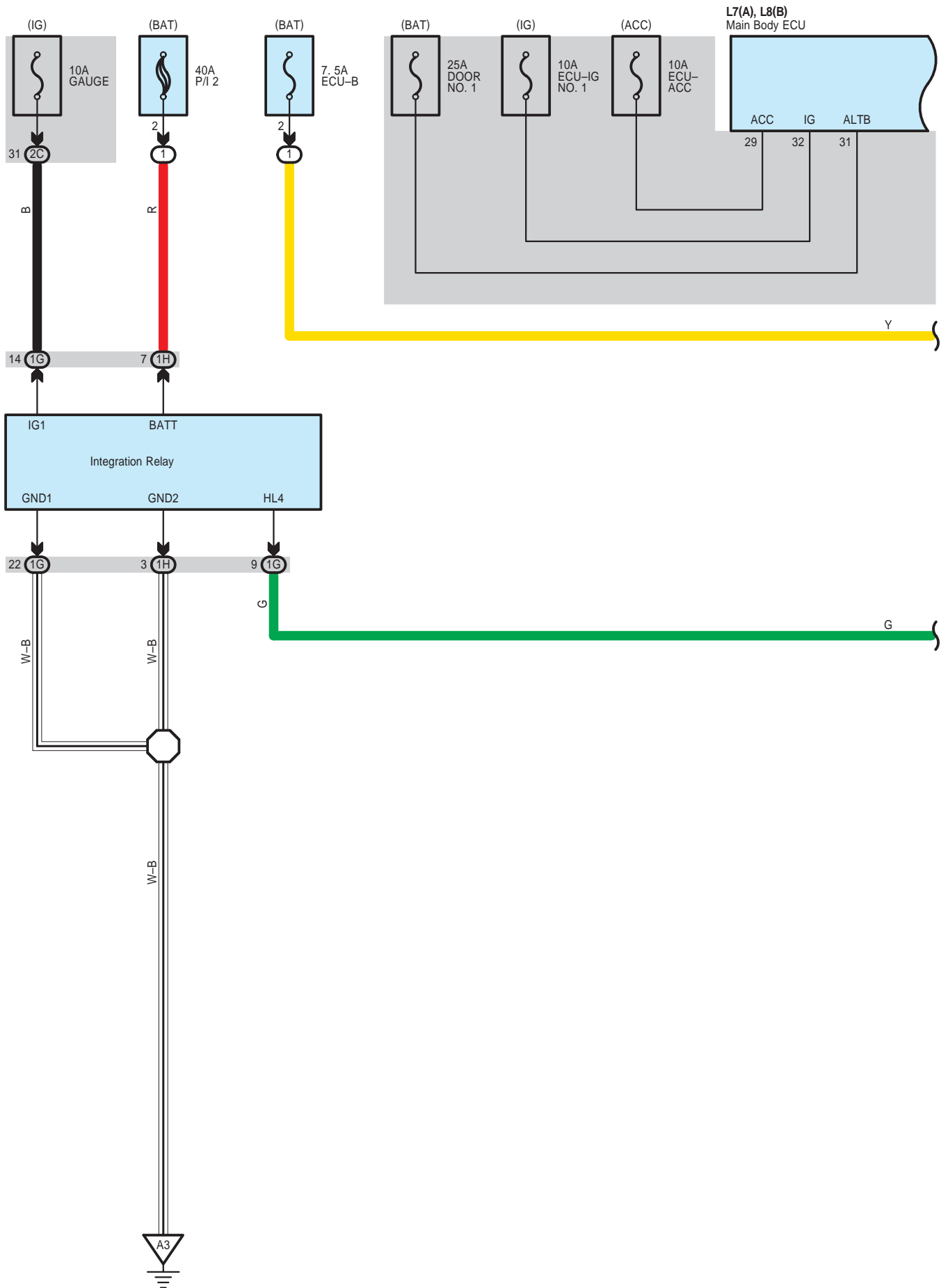

Automatic Light Control , Light Auto Turn Off System

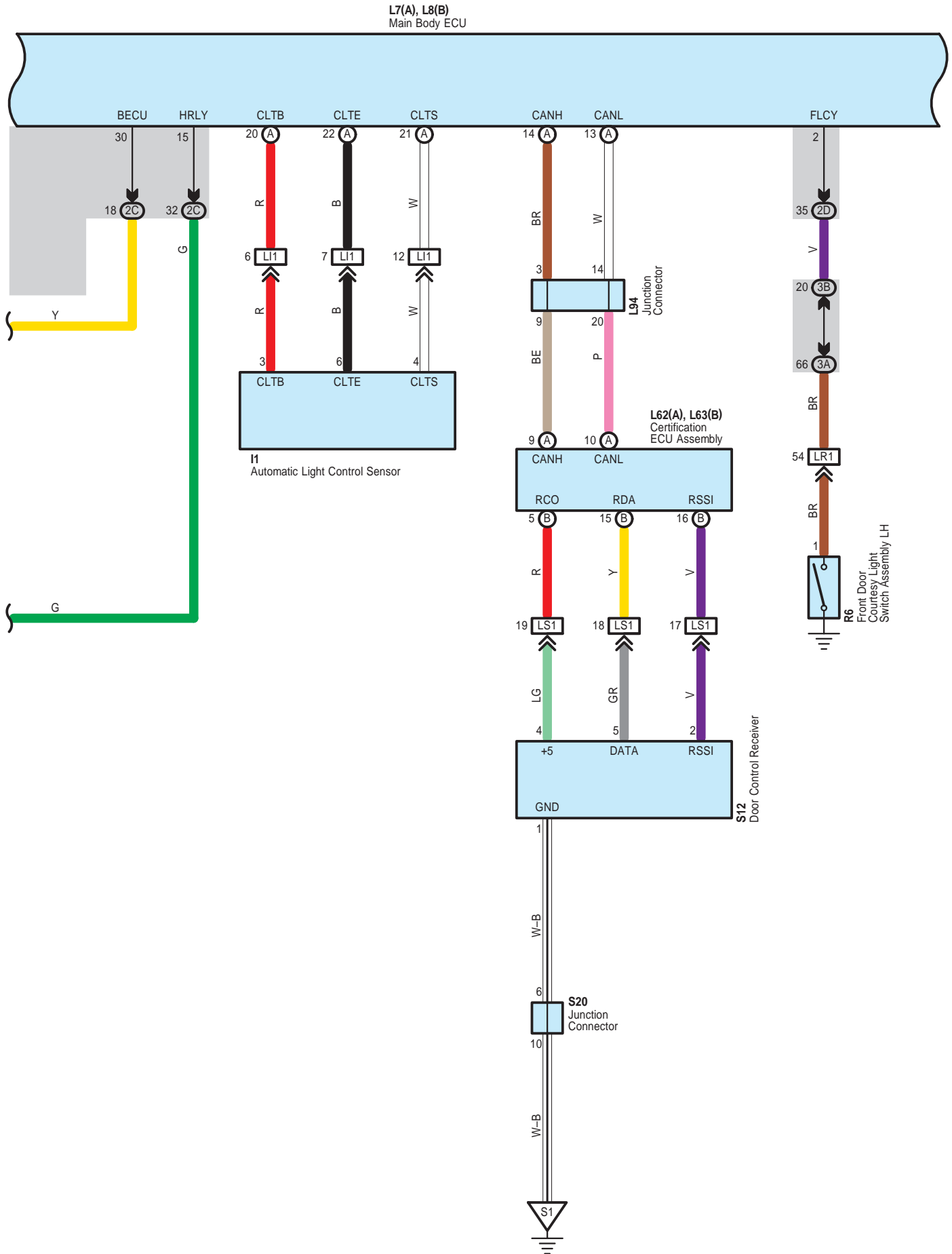

# Automatic Light Control , Light Auto Turn Off System

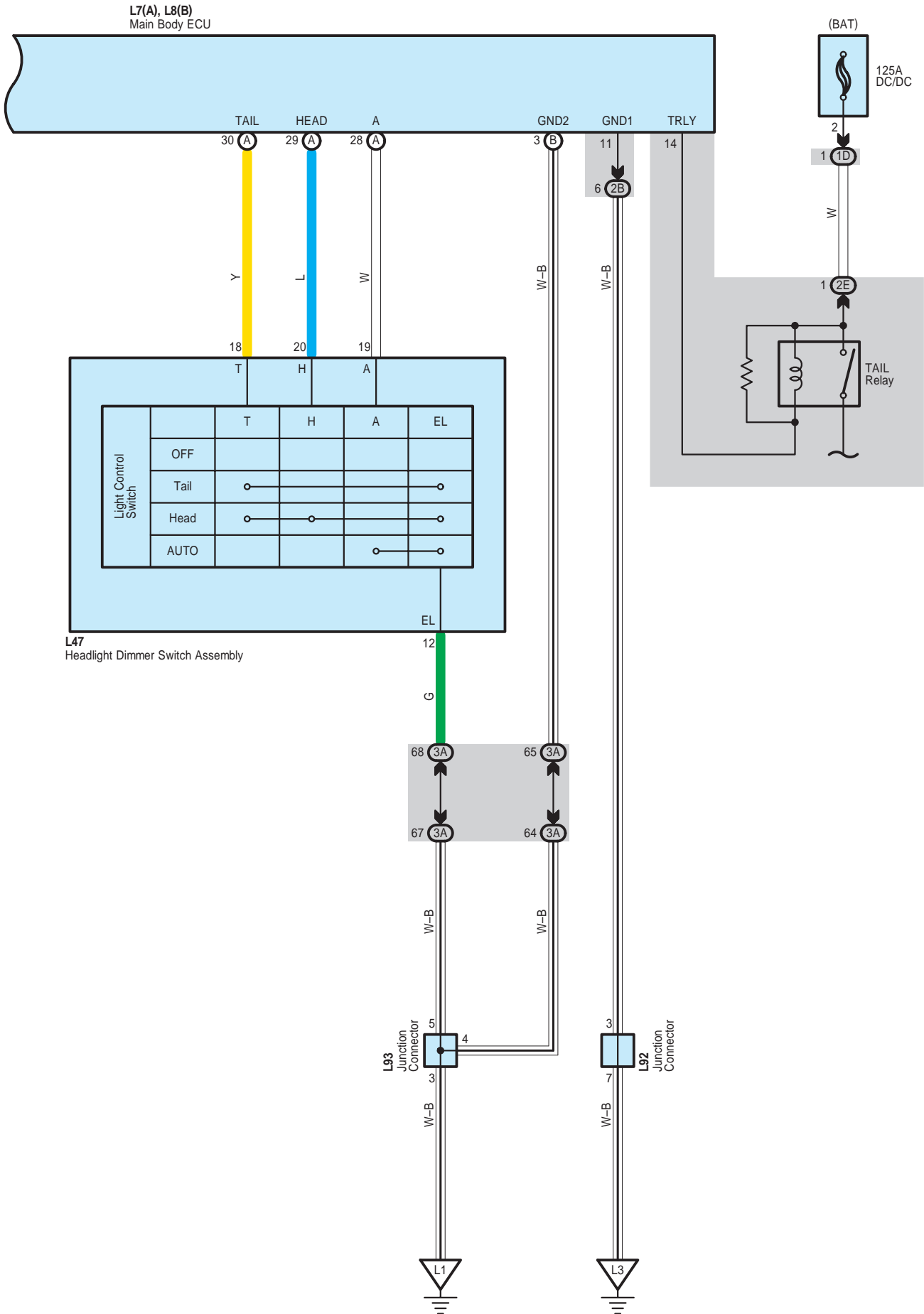

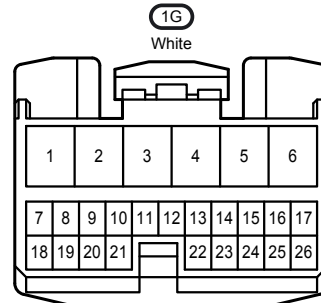
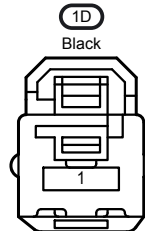
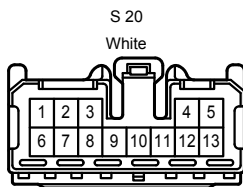
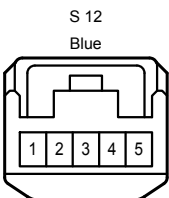
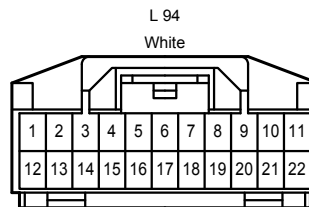
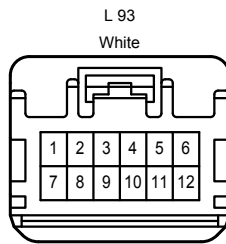
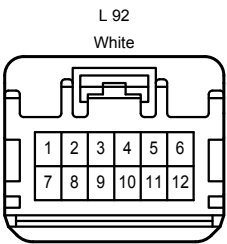
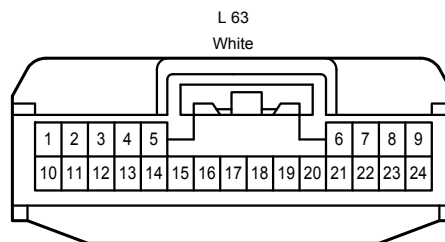
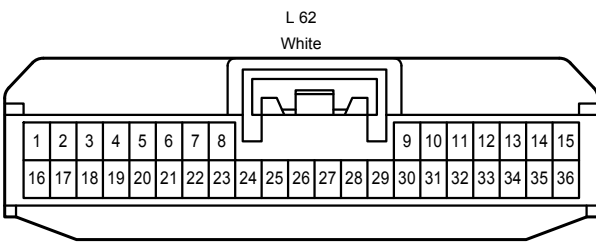
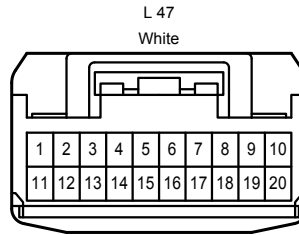
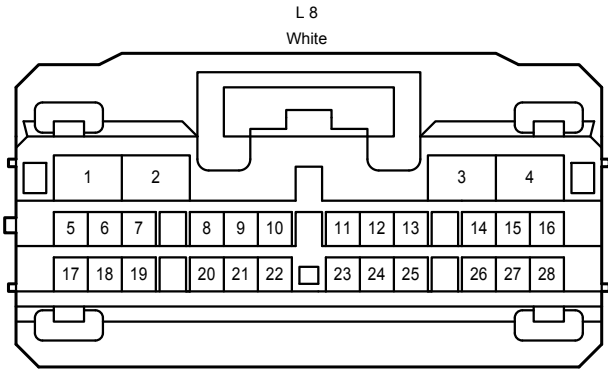
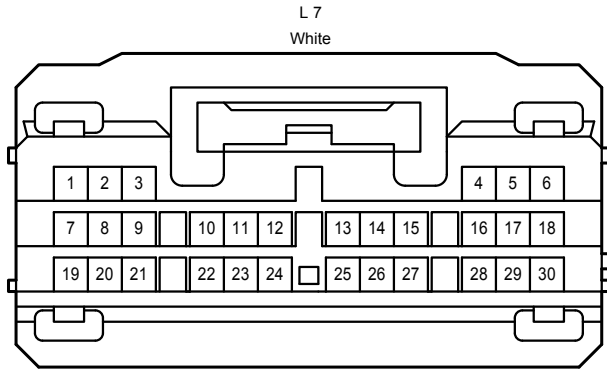
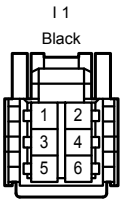

Automatic Light Control , Light Auto Turn Off System

1H

White

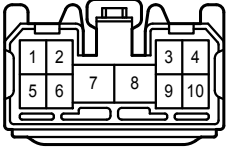

2B

White

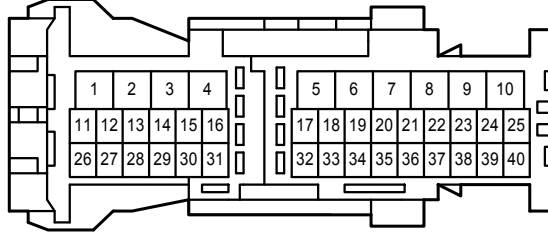

2C

White

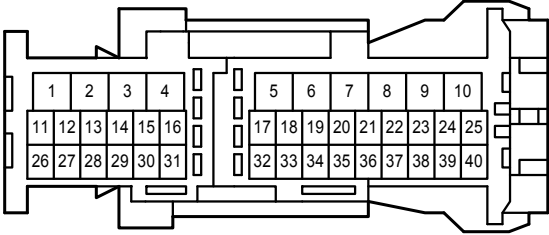

2D

White

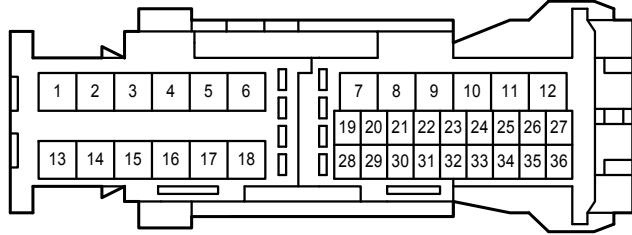

2E

White

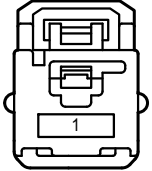

3A

White

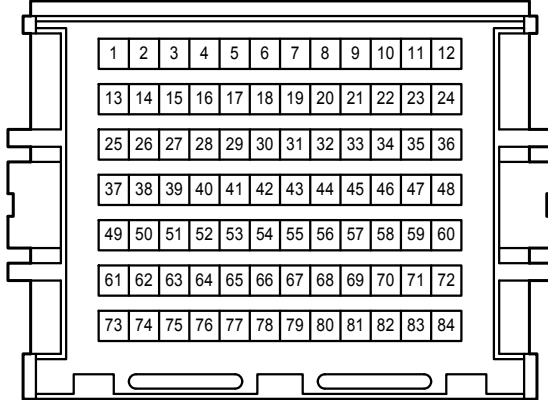

3B

White

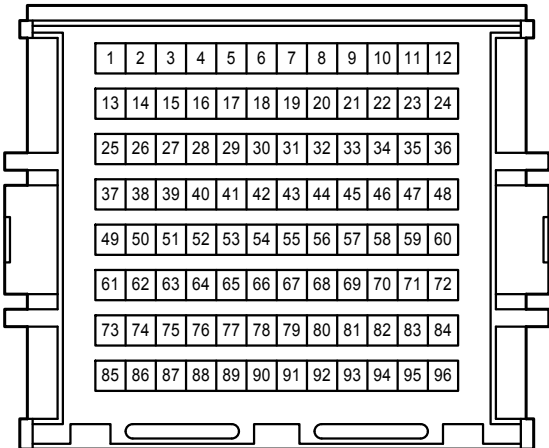

L11

Black

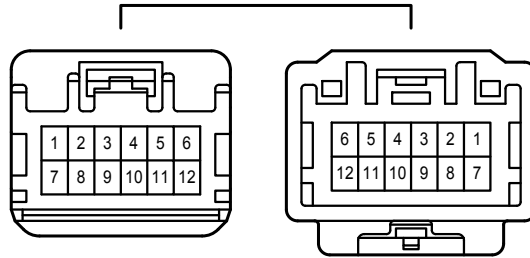

Automatic Light Control , Light Auto Turn Off System

LR1  
White

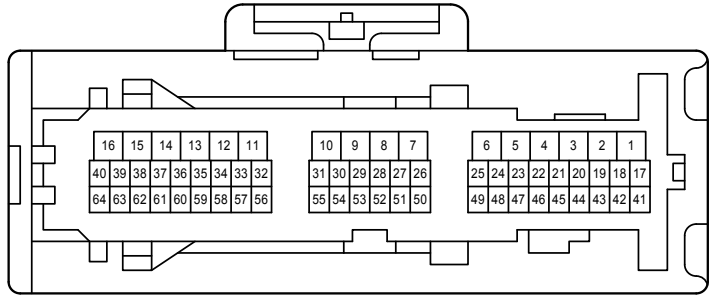
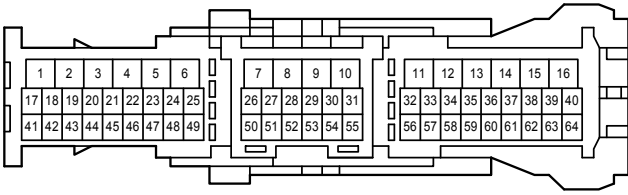

LS1  
White

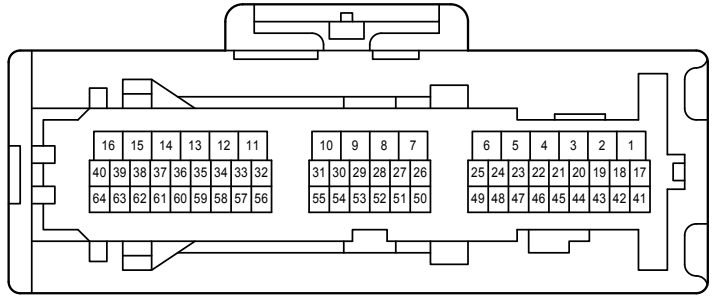
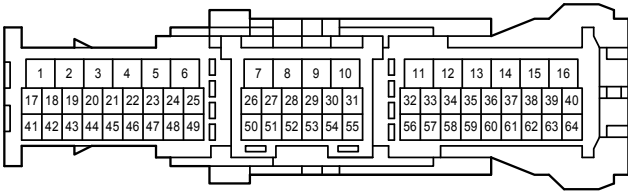

# Back-Up Light

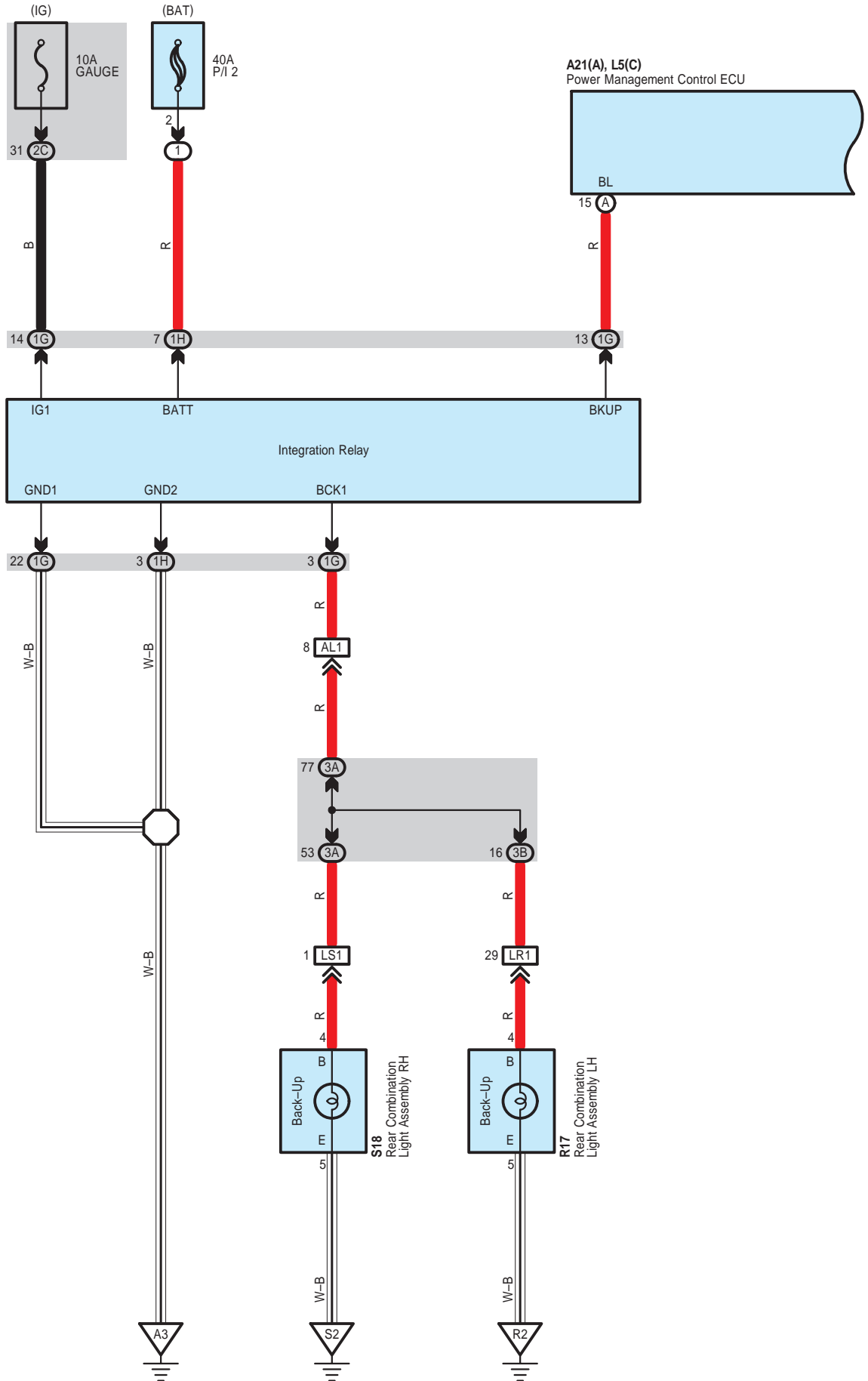

A21(A), L5(C)  
Power Management Control ECU

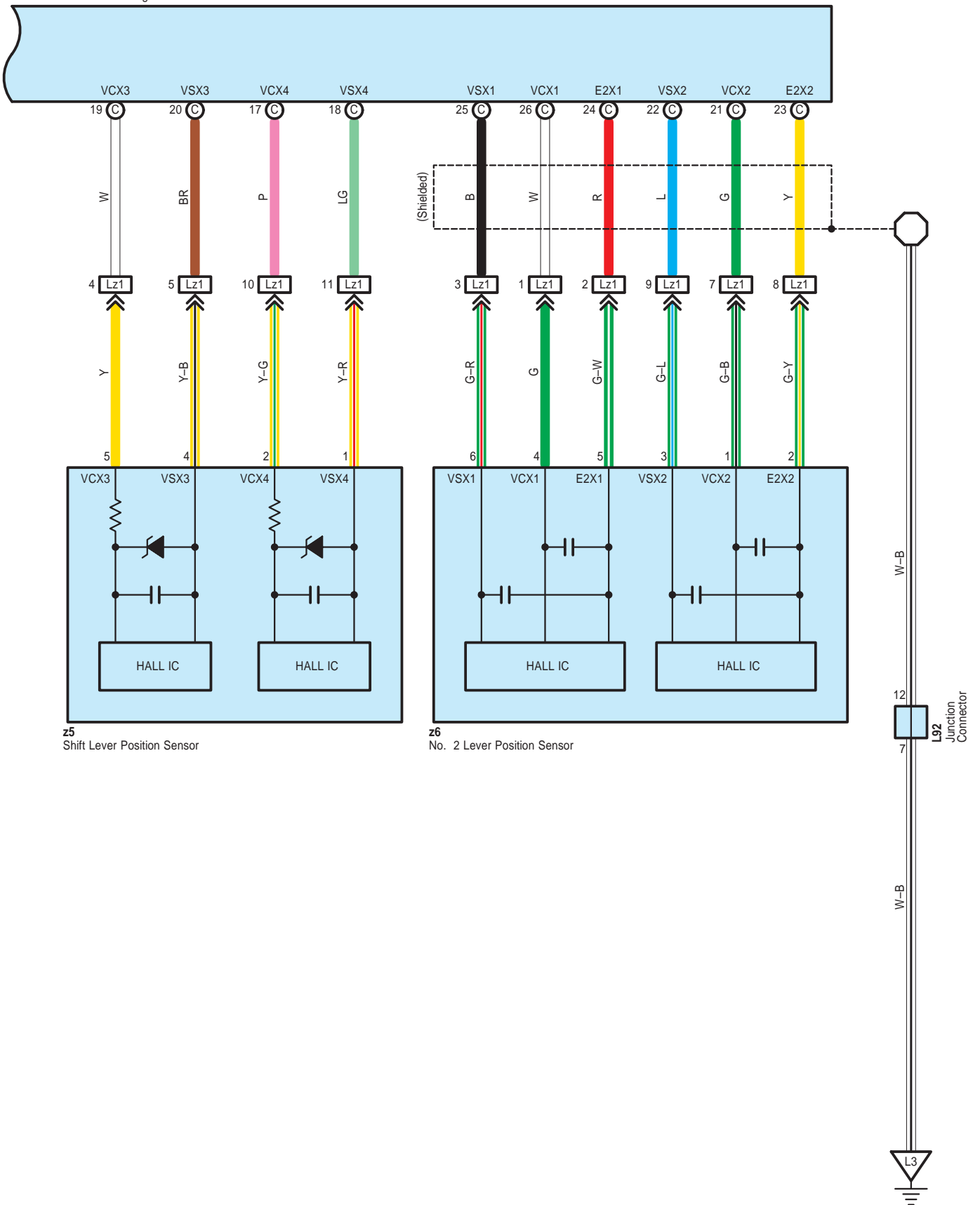



Back-Up Light

A 21  
Gray

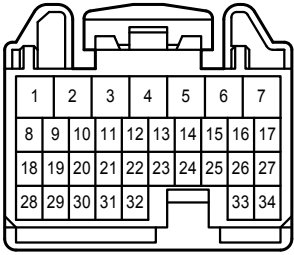

L 5  
Gray

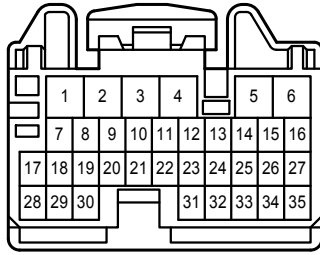

L 92  
White

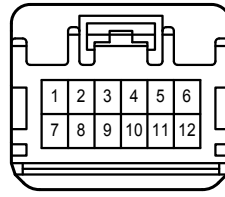

R 17  
White

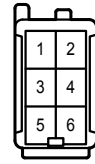

S 18  
White

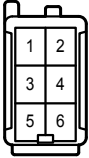

z 5  
White

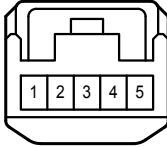

z 6  
White

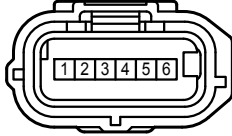

1G  
White

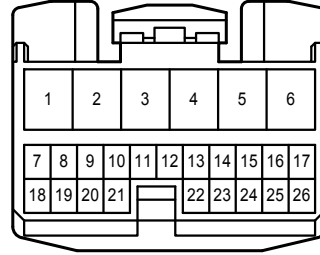

1H  
White

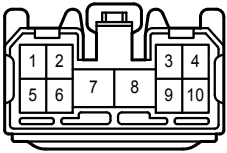

2C  
White

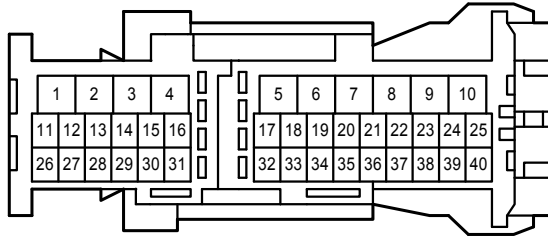

3A  
White

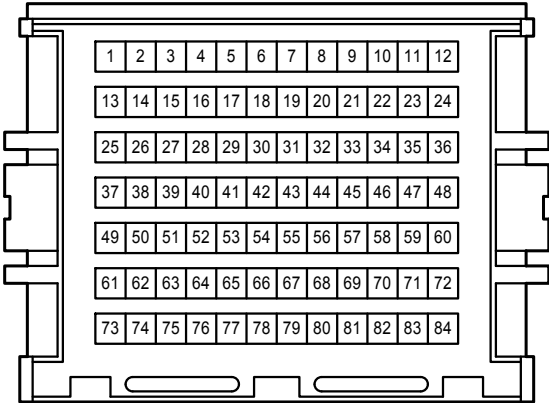

3B  
White

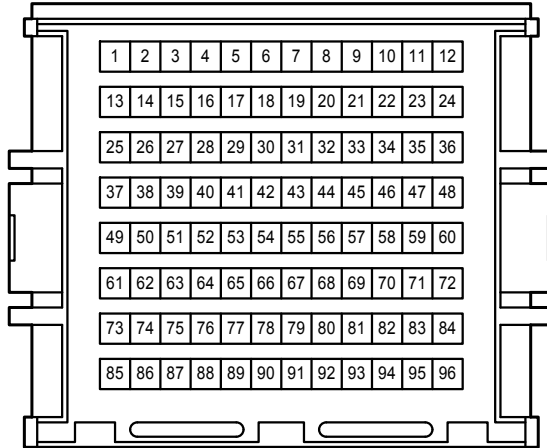

Back-Up Light

AL1  
Blue

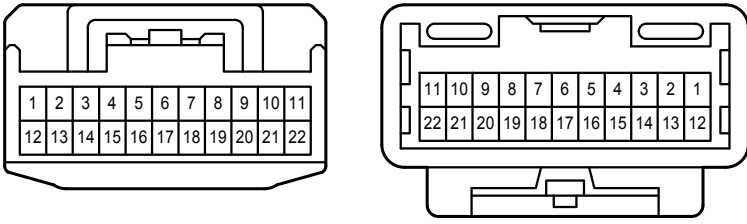

LR1  
White

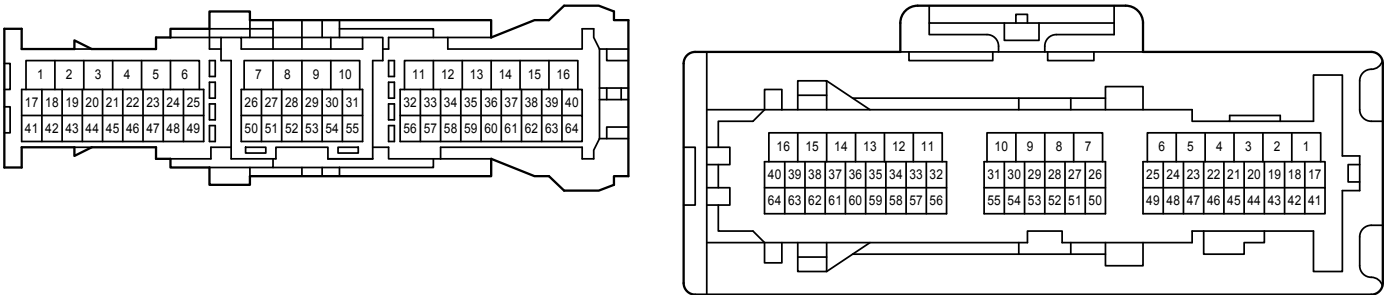

LS1  
White

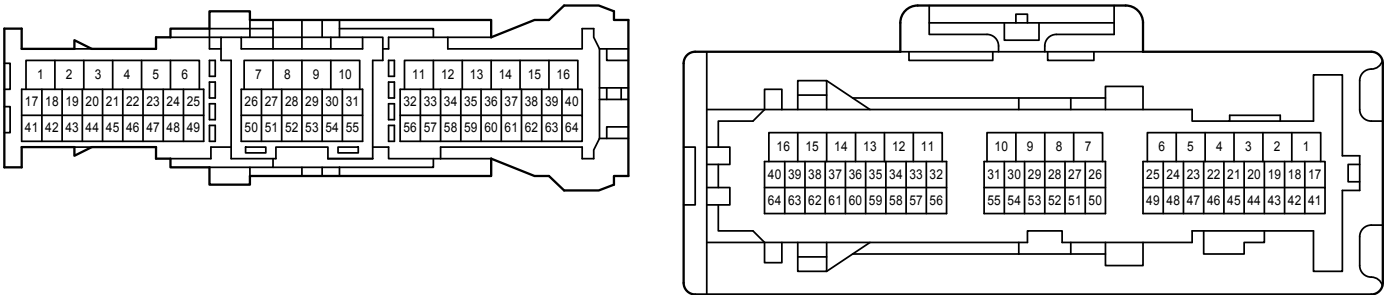

Lz1  
White

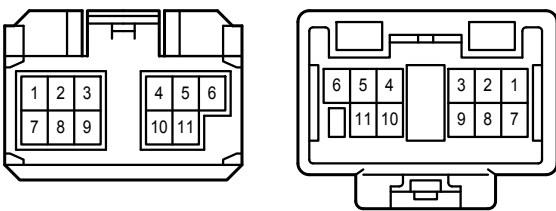

# Combination Meter

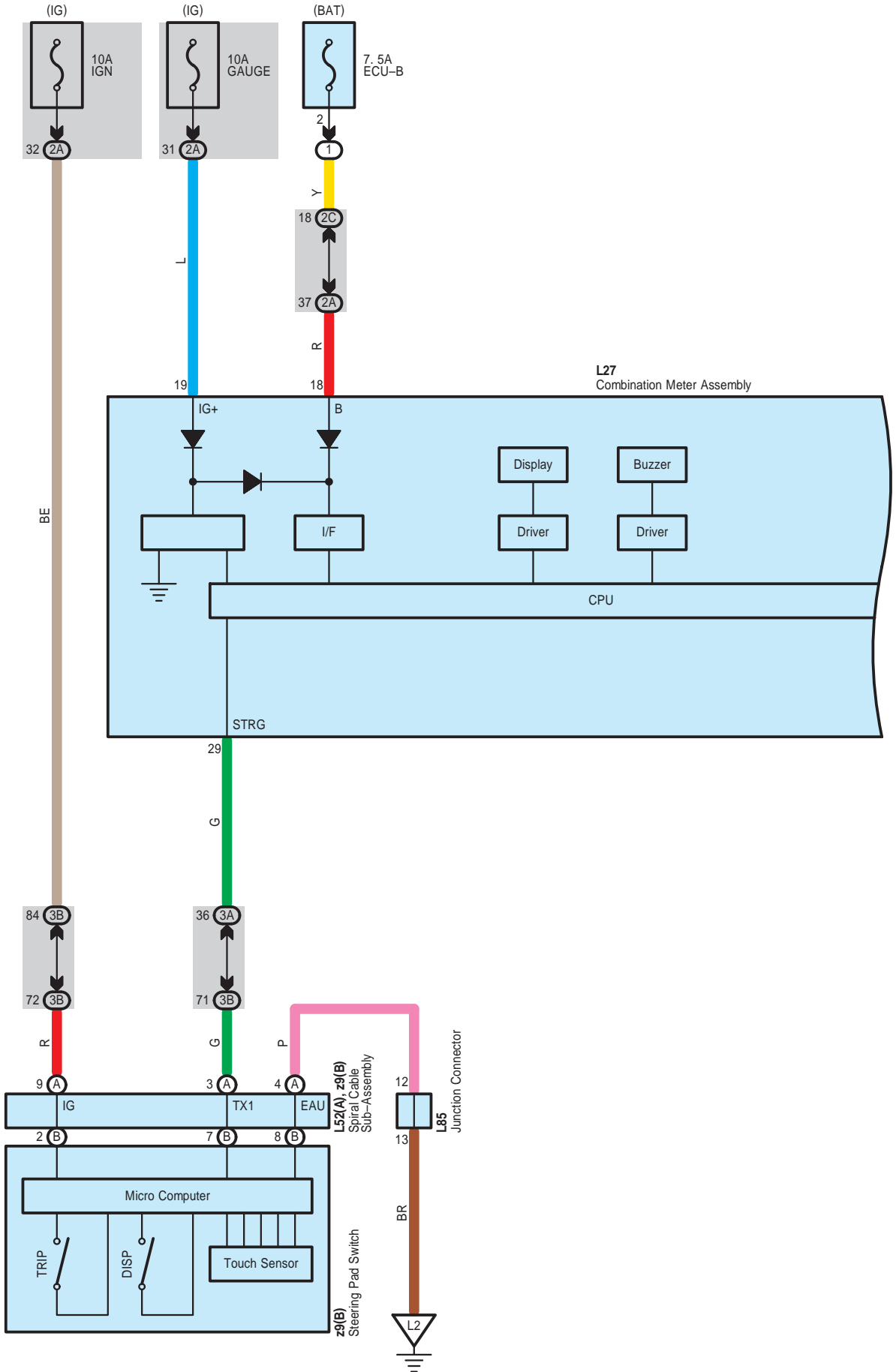

# Combination Meter

- \* 1 : w/ Navigation System
- \* 2 : w/ Stereo Component Amplifier
- \* 3 : w/o Stereo Component Amplifier
- \* 4 : w/ Safety Connect System

L27  
Combination Meter Assembly

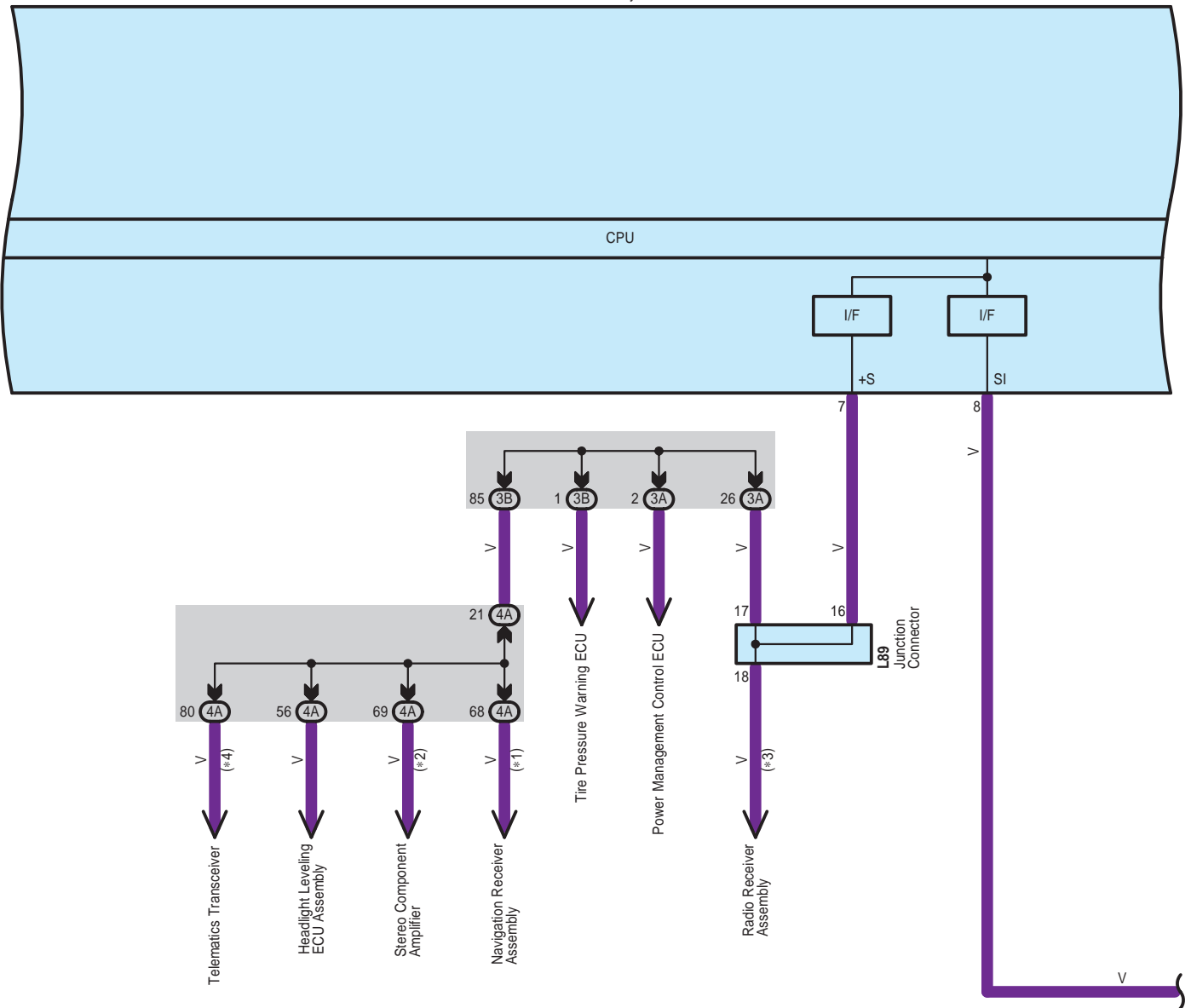

Combination Meter

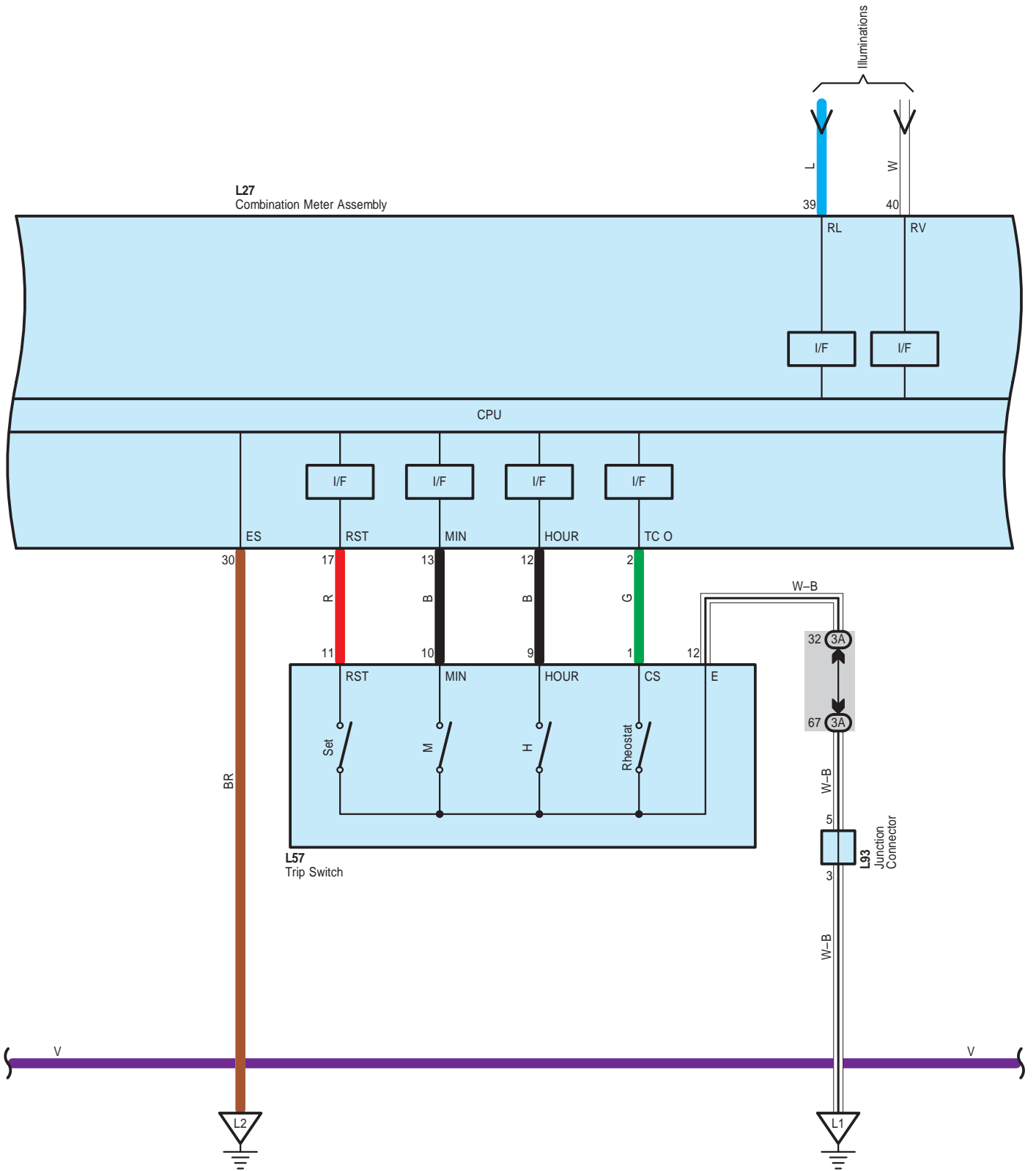

# Combination Meter

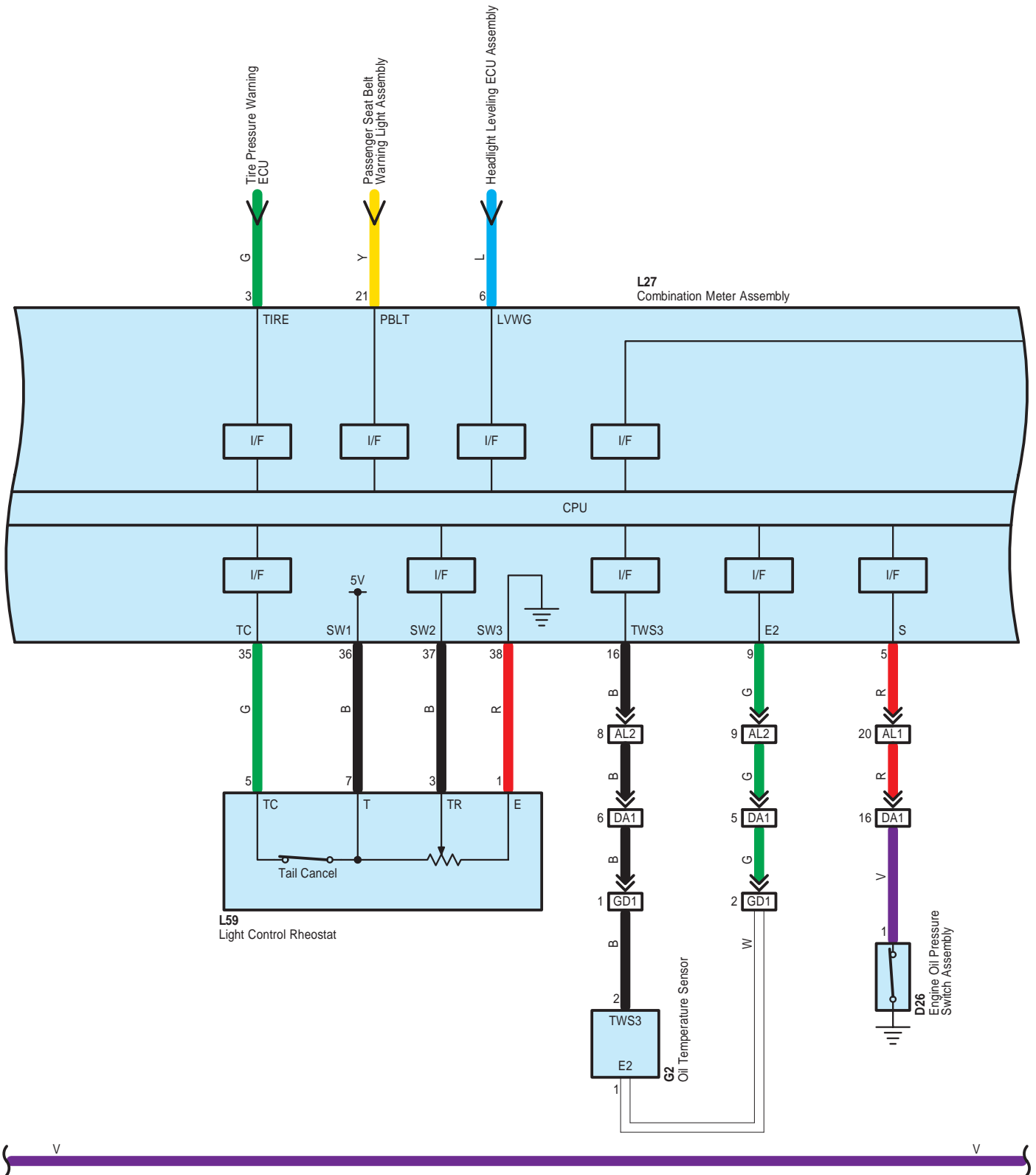

# Combination Meter

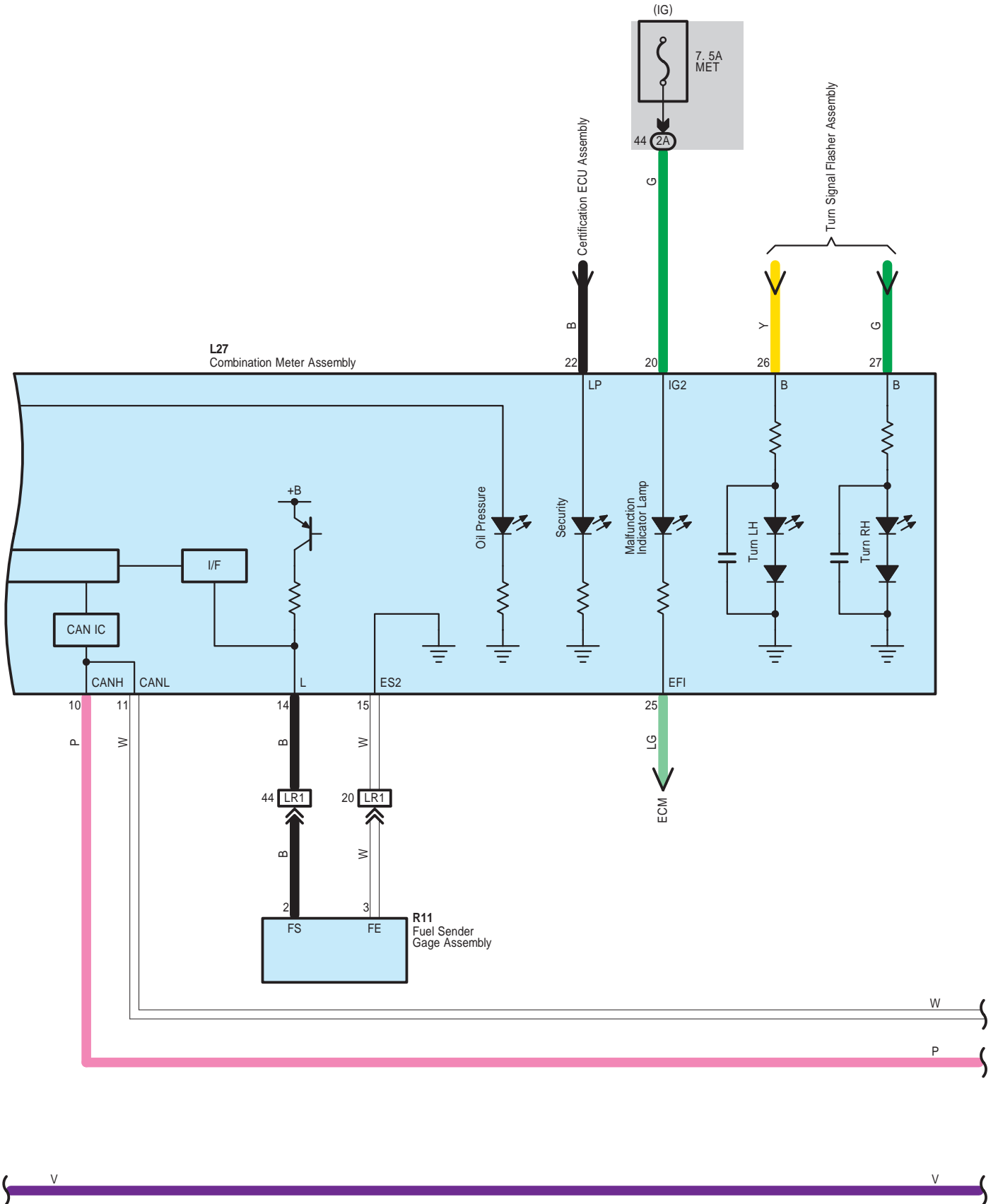

# Combination Meter

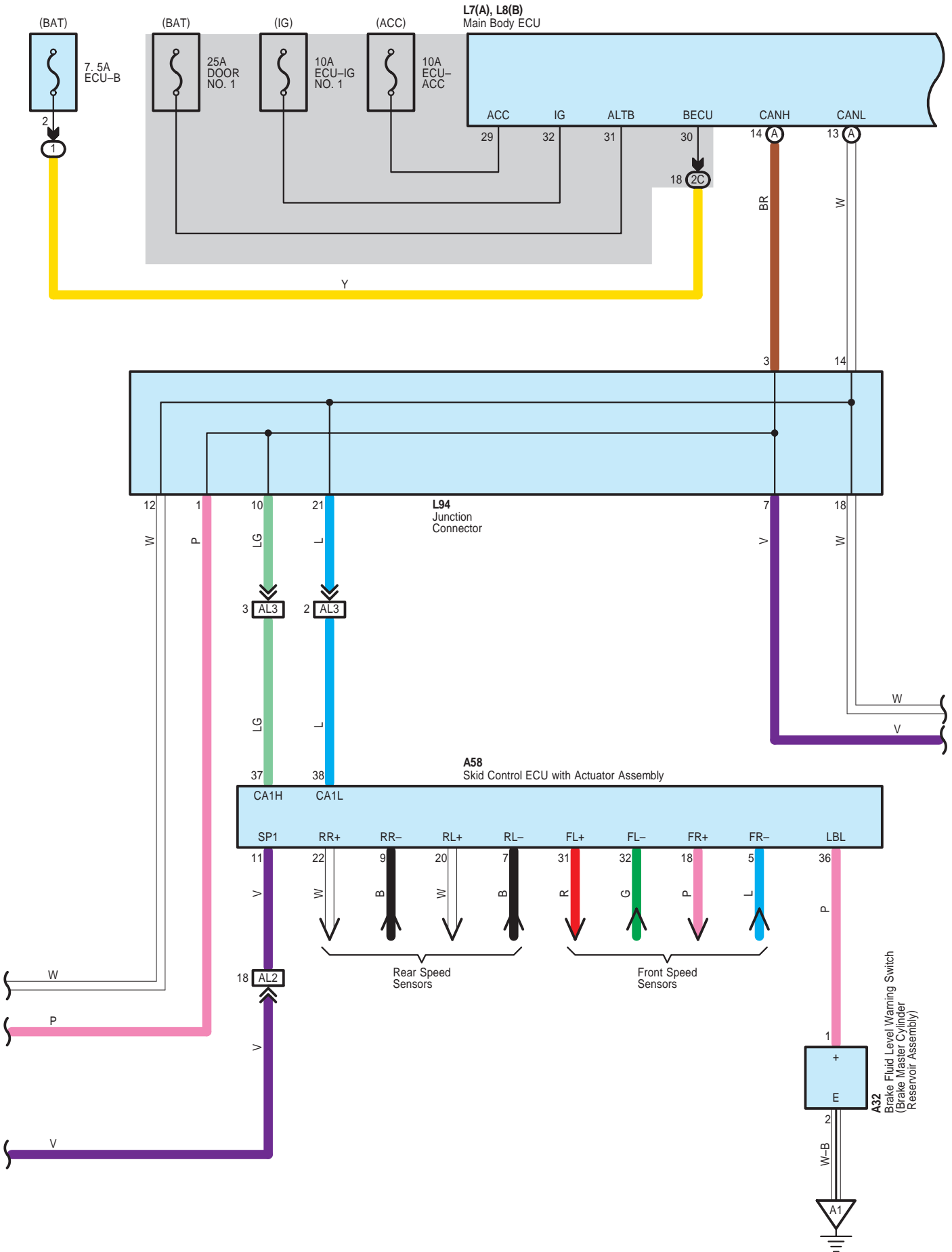





Combination Meter

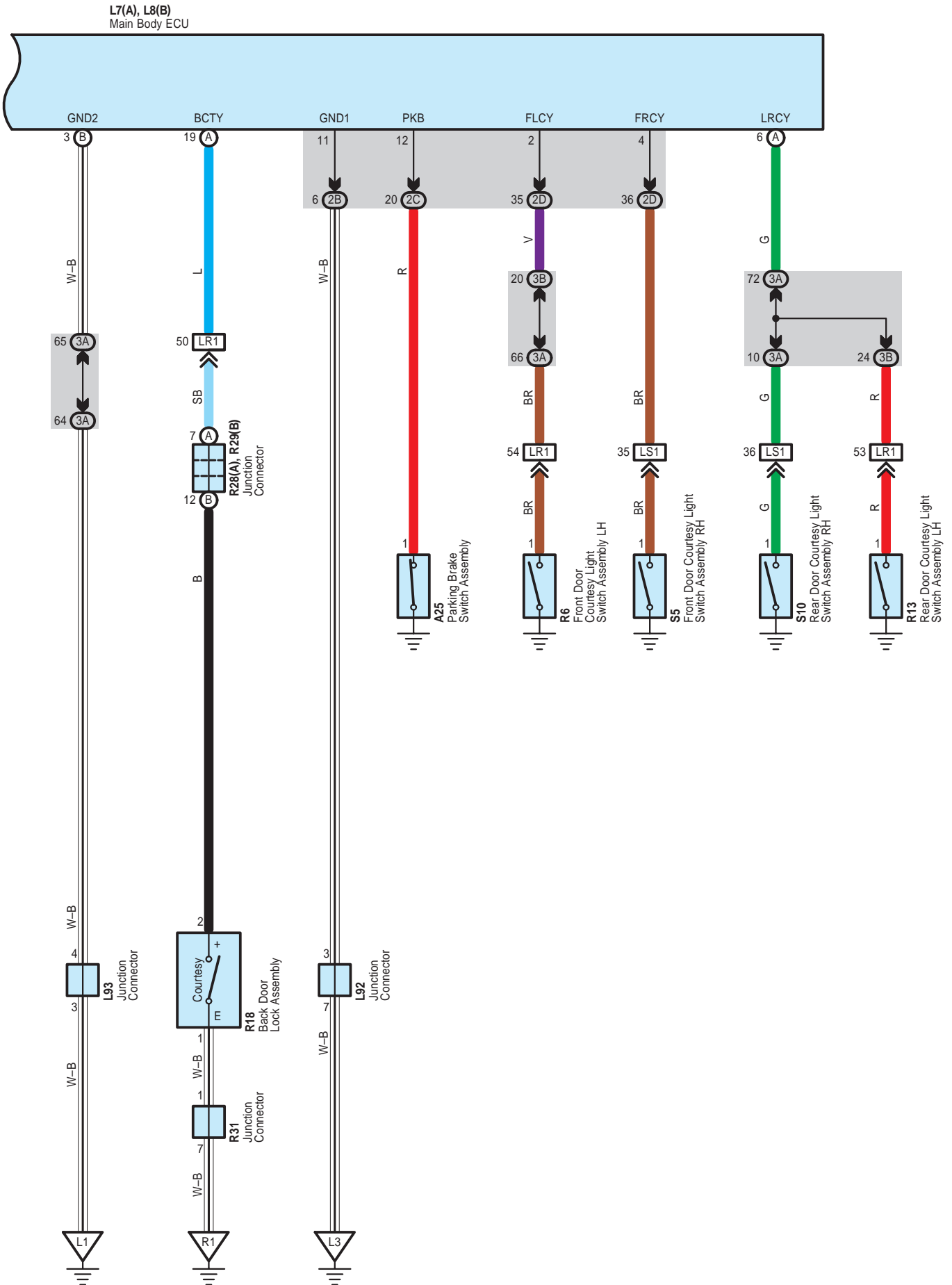

# Combination Meter

A 25  
White



A 32  
Black

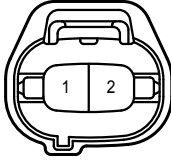

A 57  
Black

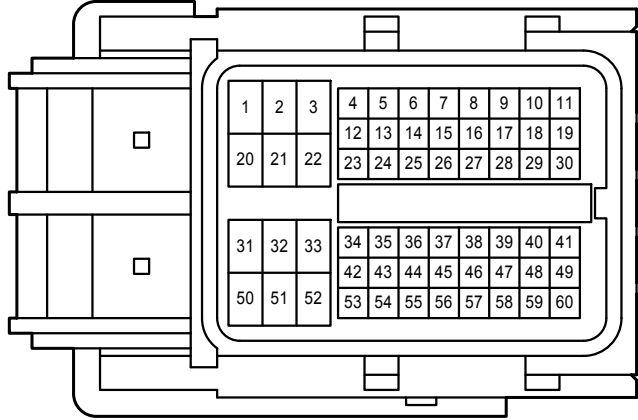

A 58  
Gray

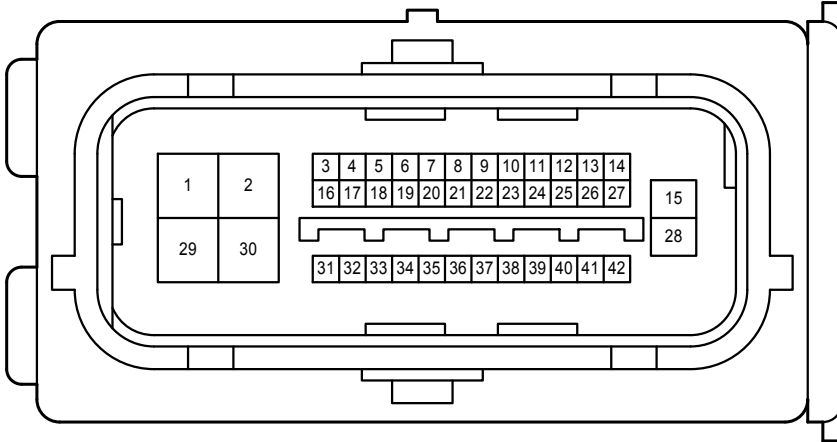

D 6  
Black



D 14  
Black

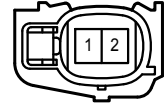

D 26  
Gray



D 27  
Black

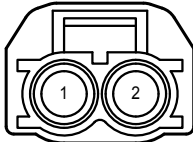

D 28  
Black

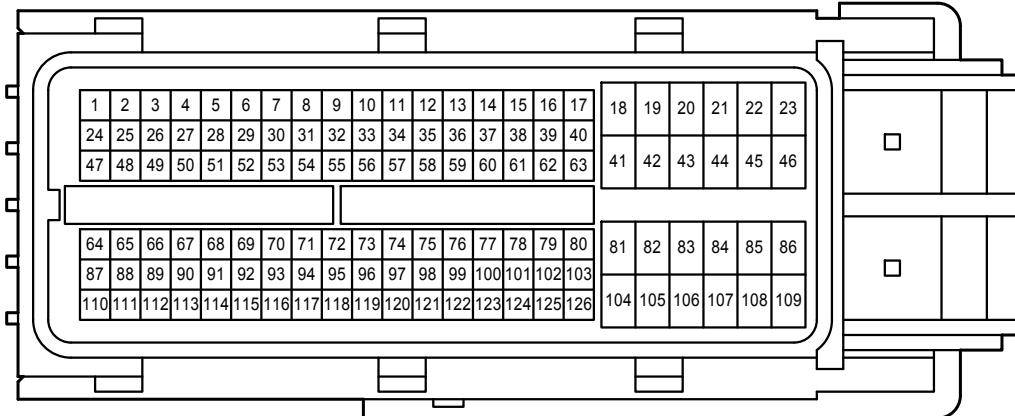

G 2  
Black



Combination Meter

L 7  
White

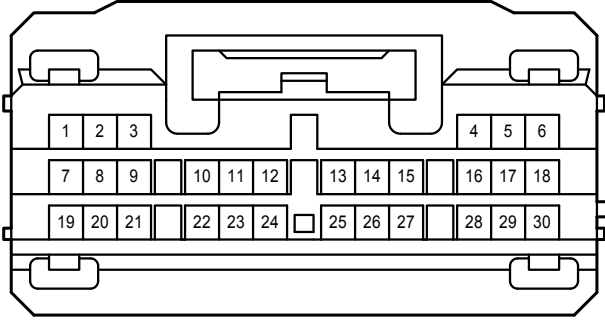

L 8  
White

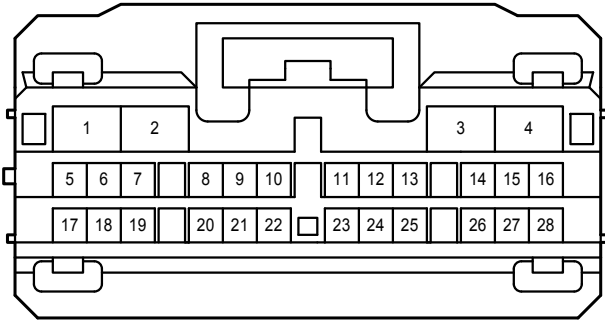

L 27  
White

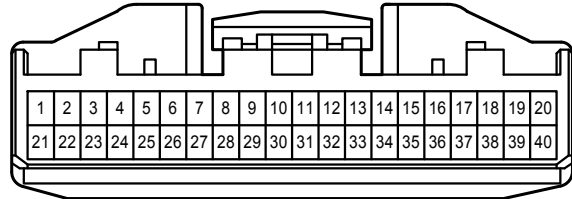

L 52  
Black



L 57  
Black

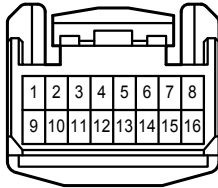

L 59  
White

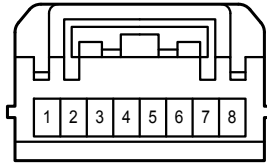

L 85  
White

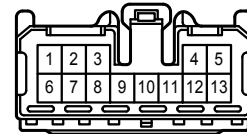

L 89  
Black

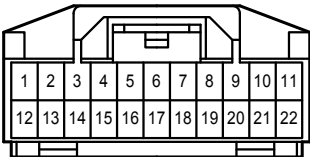

L 92  
White

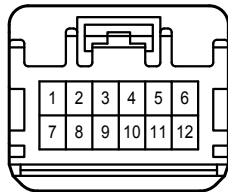

L 93  
White

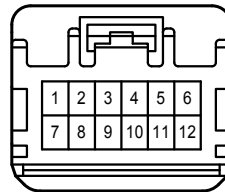

L 94  
White

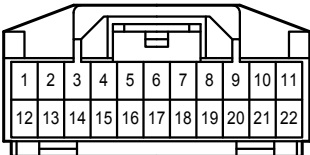

L 95  
White

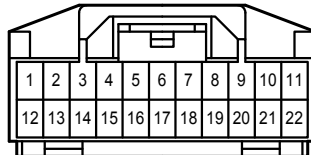

R 6  
Black



R 11  
Dark Gray



R 13  
Black



R 18  
White

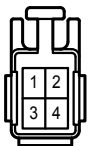

R 28  
White

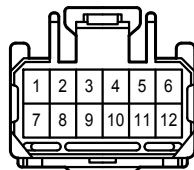

R 29  
White

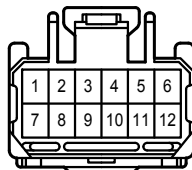

R 31  
White

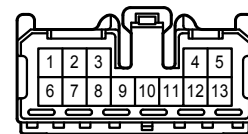

Combination Meter

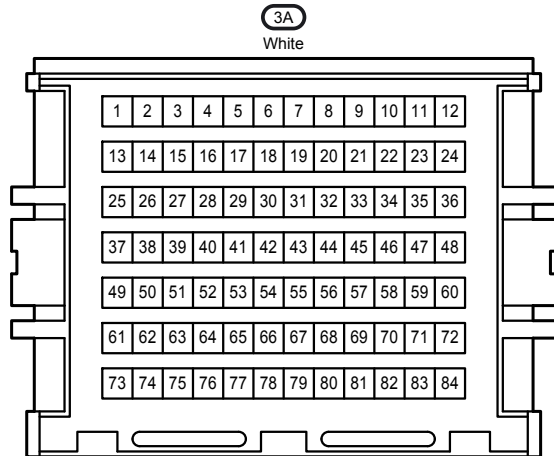
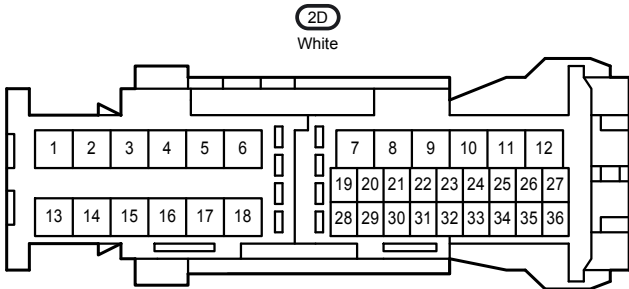
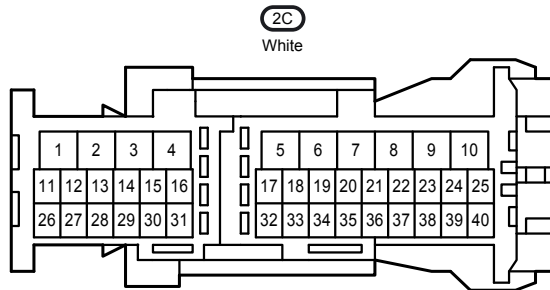
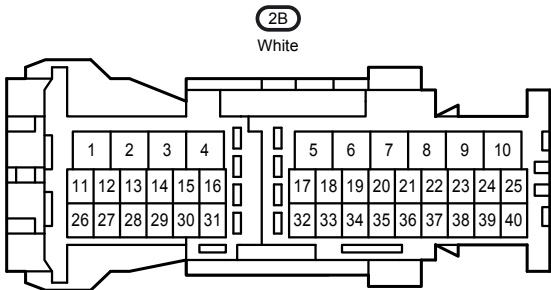
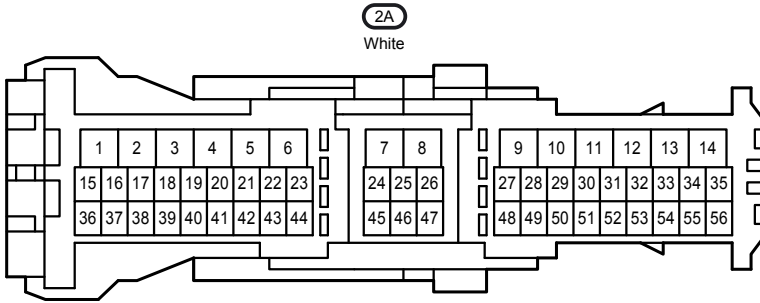
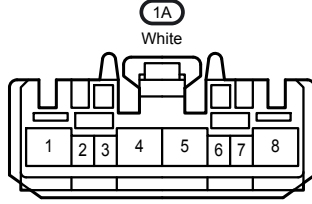
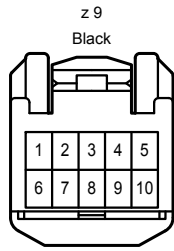

Combination Meter

3B  
White

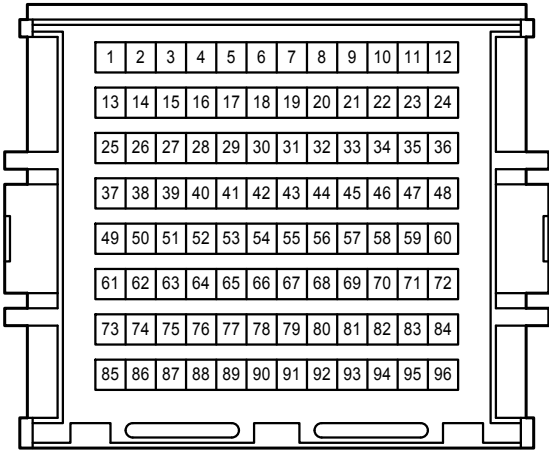

4A  
White

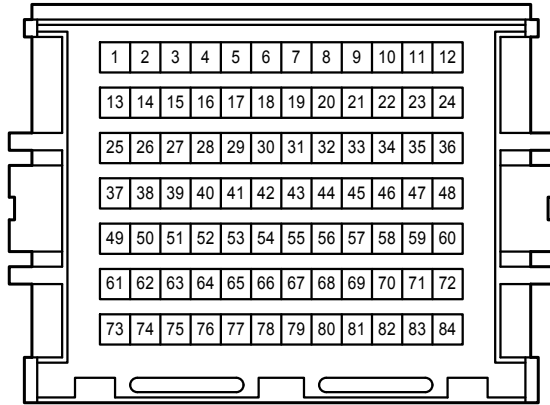

AL1  
Blue

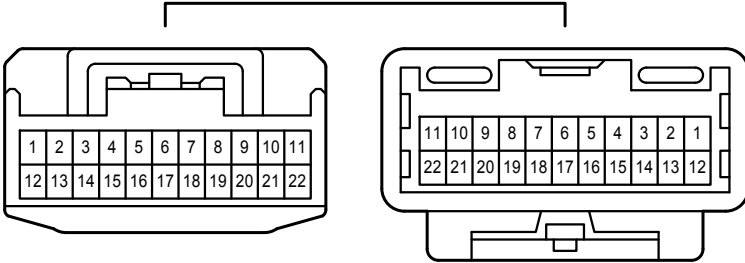

AL2  
Gray

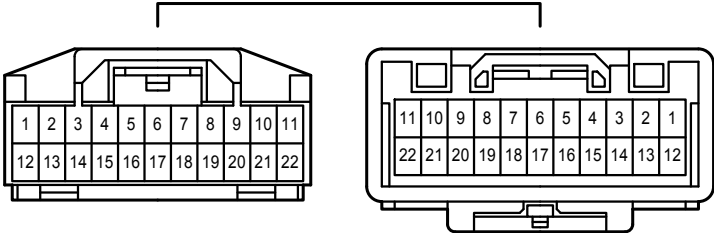

AL3  
White

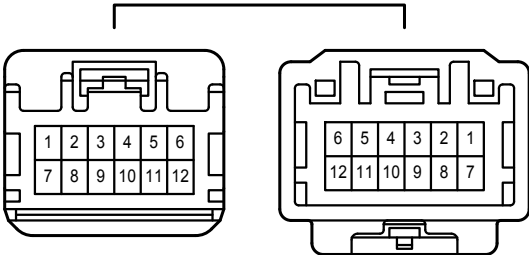

DA1  
White

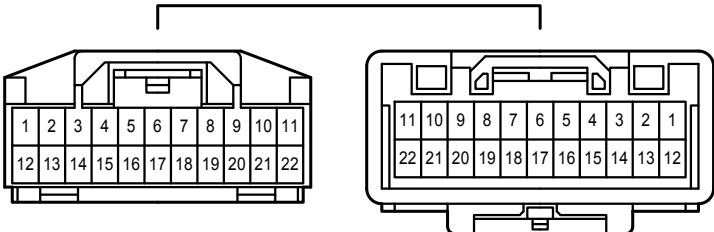

Combination Meter

DA2  
White

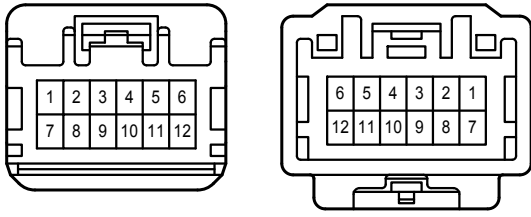

GD1  
Black

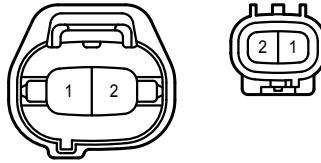

LR1  
White

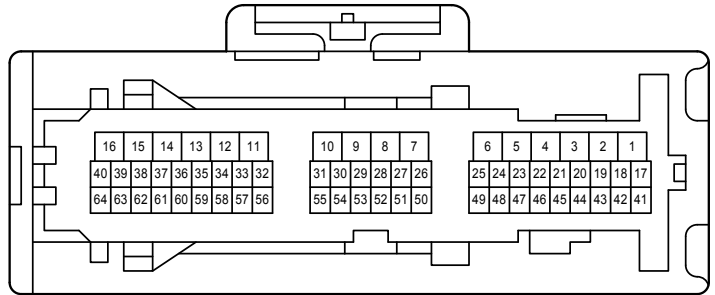
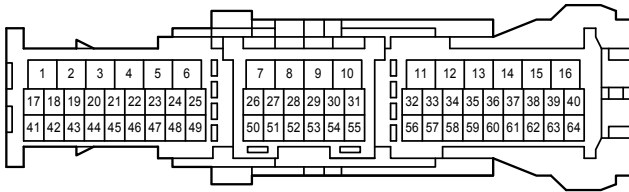

LS1  
White

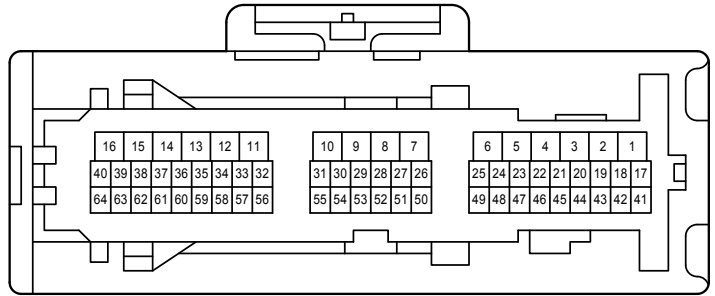
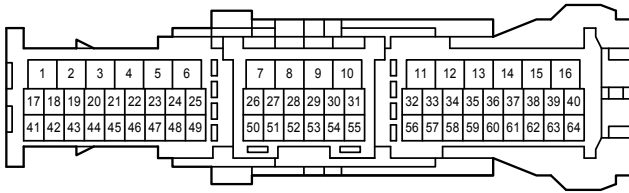

# Cooling Fan

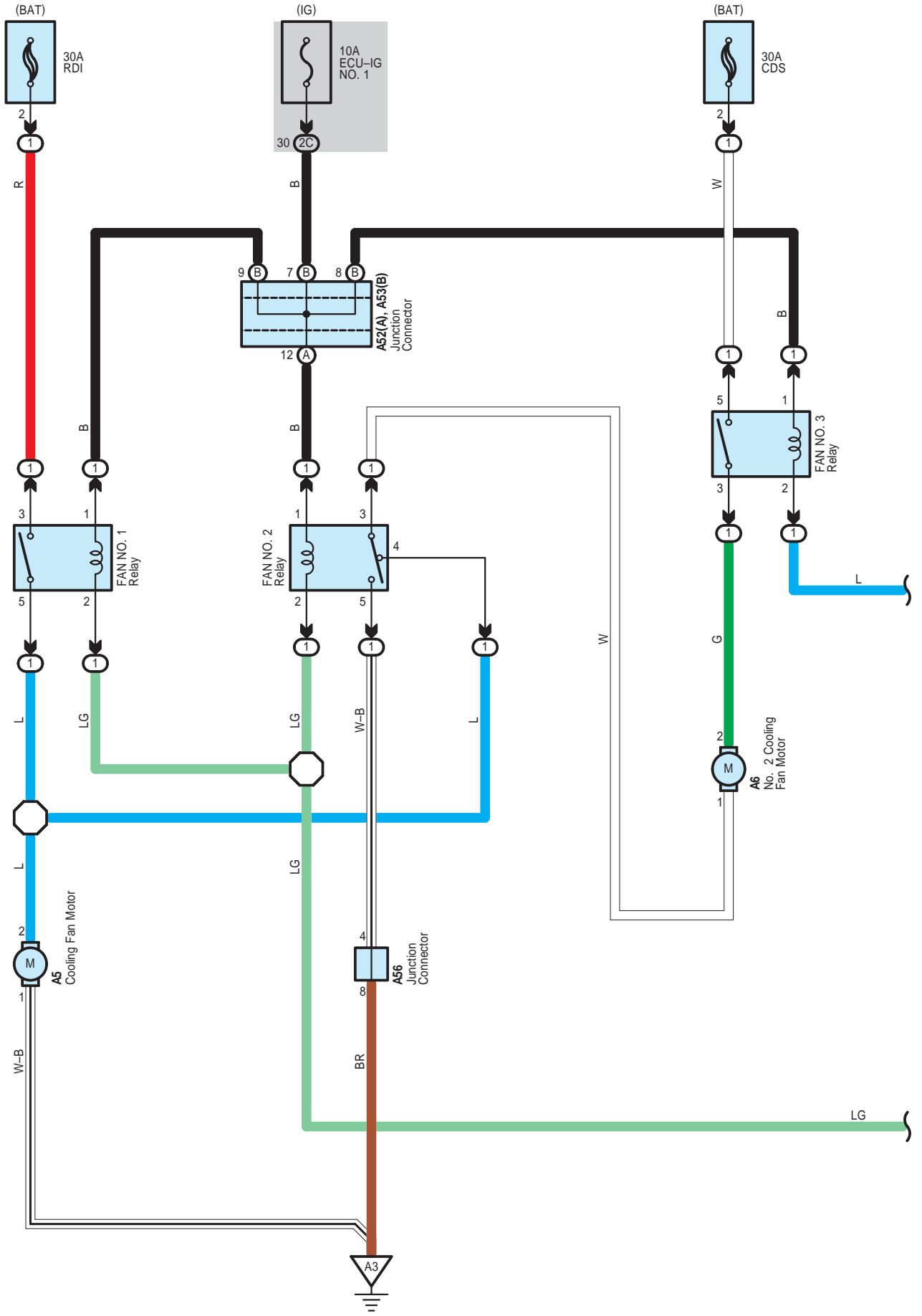



# Cooling Fan

A57(A), D28(B)  
ECM

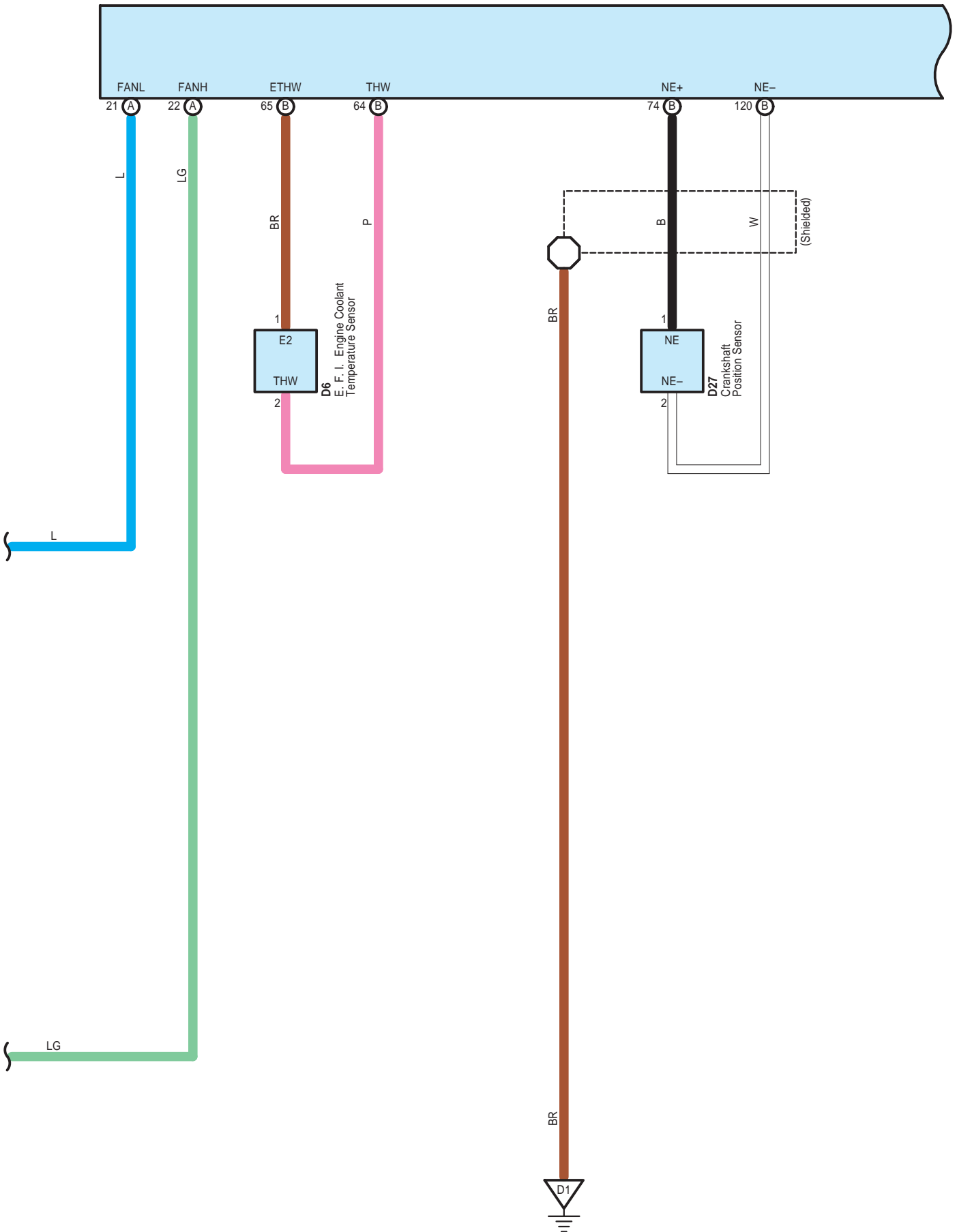

Cooling Fan

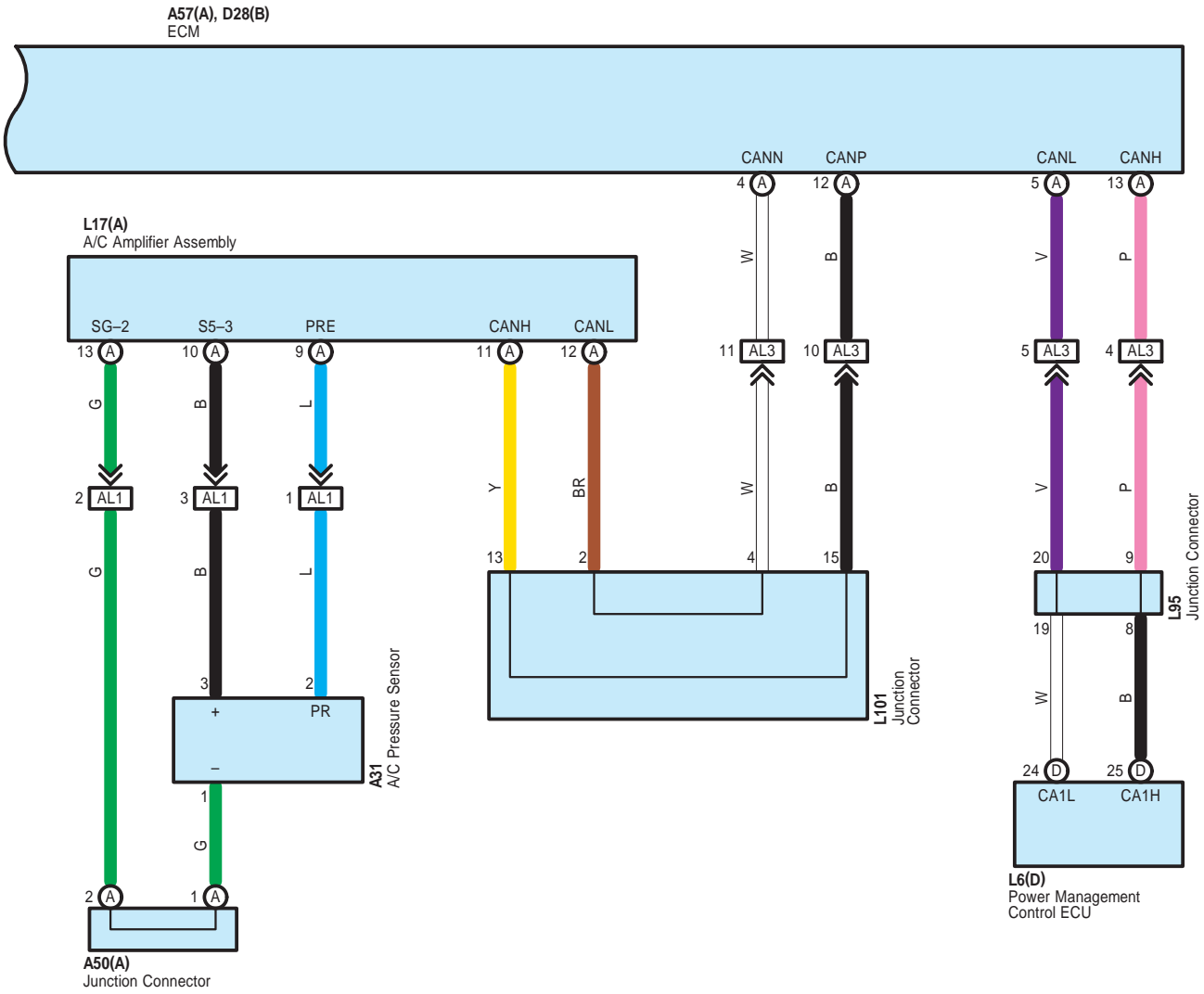

Cooling Fan

A 5  
Gray

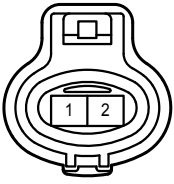

A 6  
Black

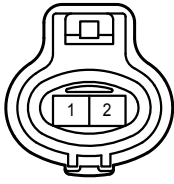

A 31  
Black

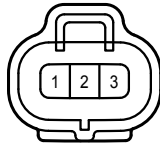

A 50  
White

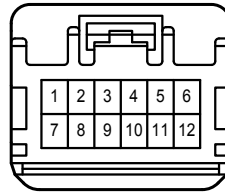

A 52  
Black

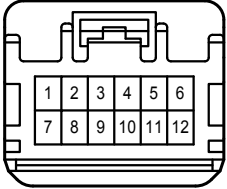

A 53  
Black

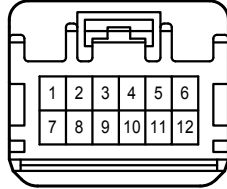

A 56  
White

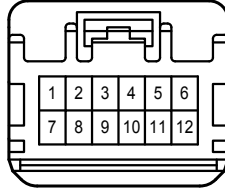

A 57  
Black

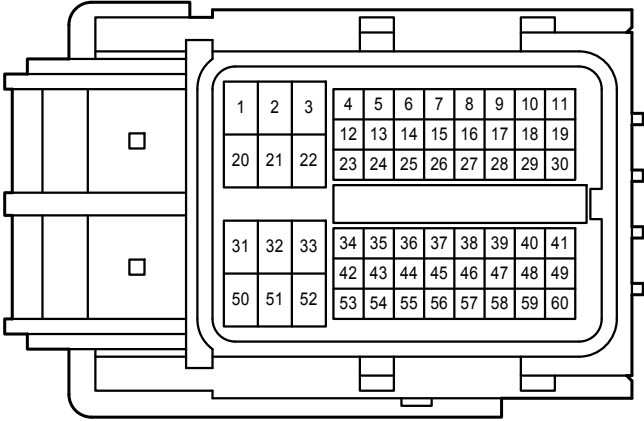

D 6  
Black



D 27  
Black

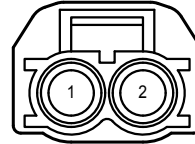

D 28  
Black

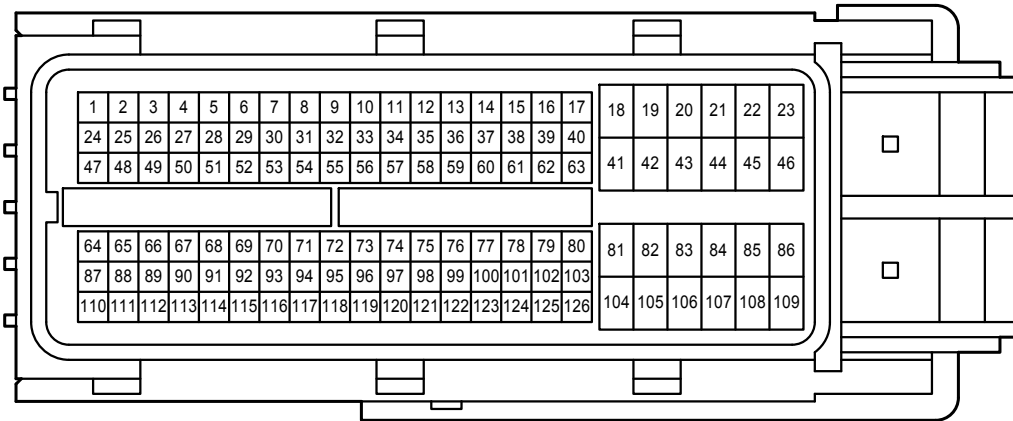

Cooling Fan

L 6  
Gray

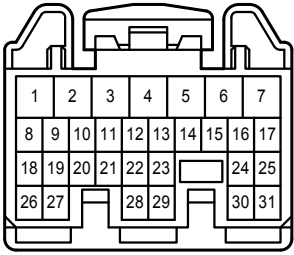

L 17  
White

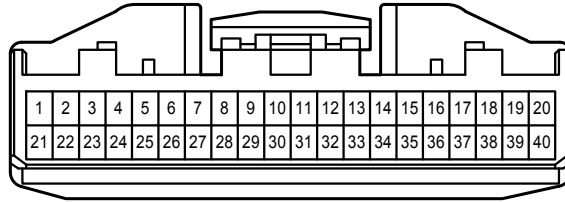

L 95  
White

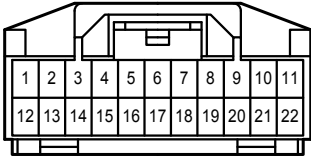

L101  
Black

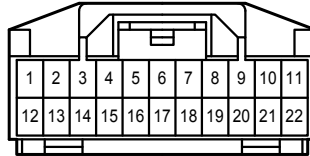

2C  
White

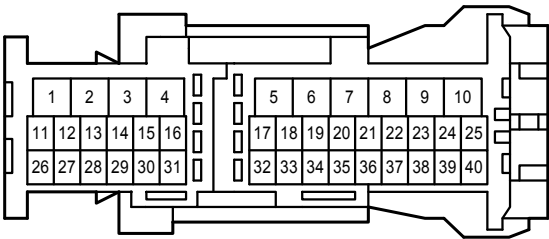

AL1  
Blue

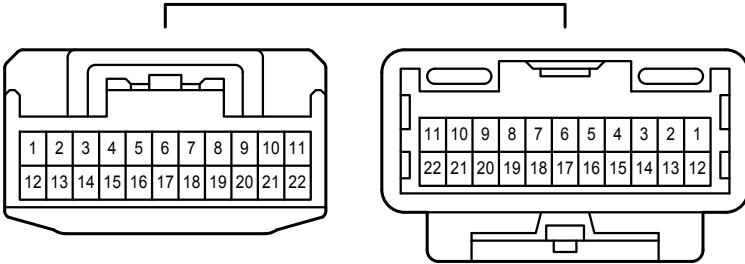

AL3  
White

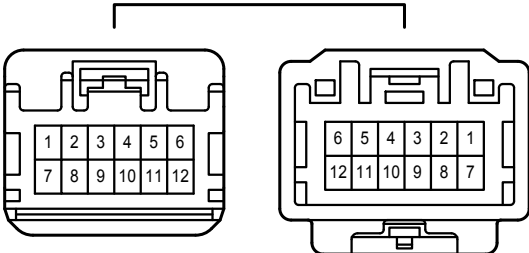



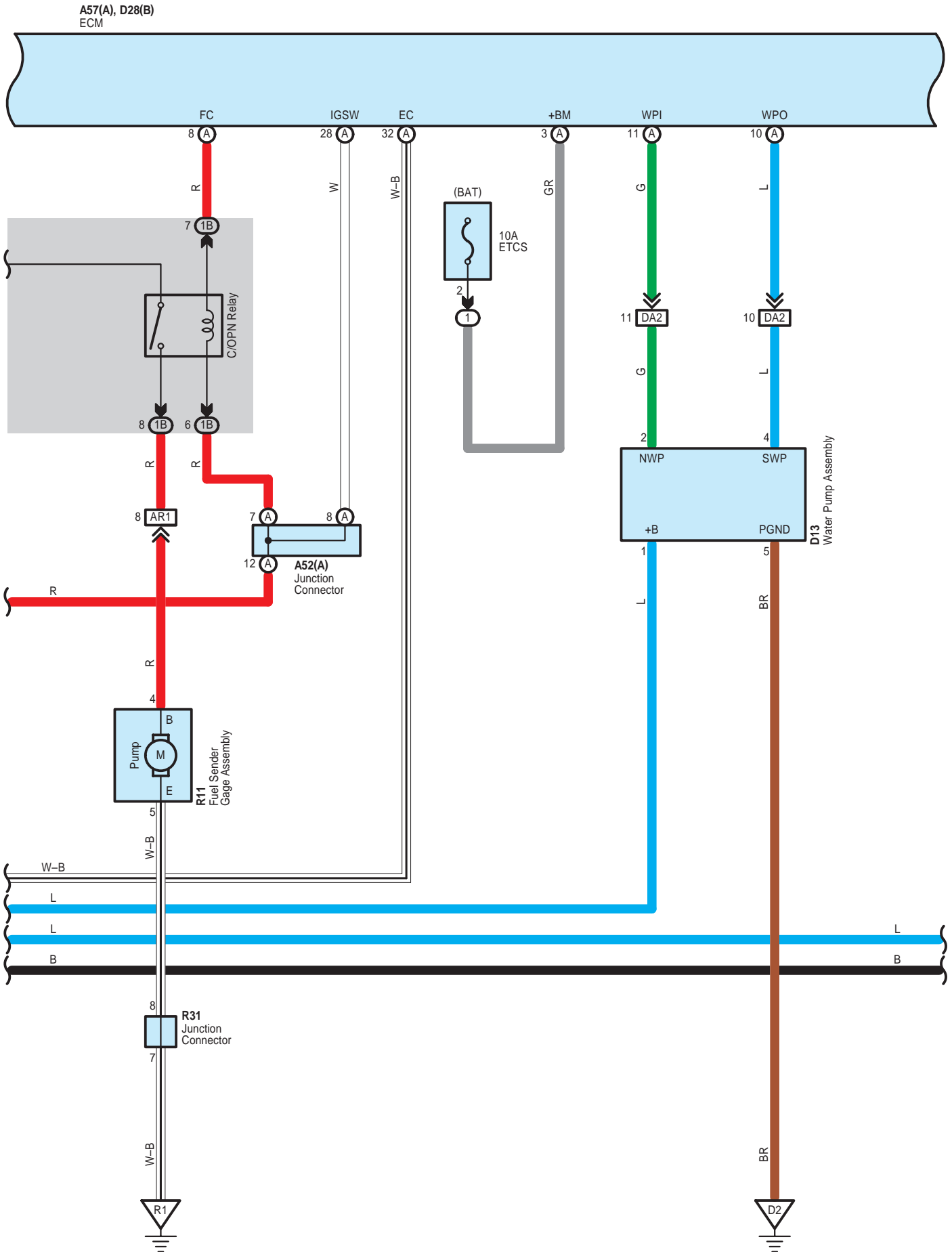

A57(A), D28(B)  
ECM

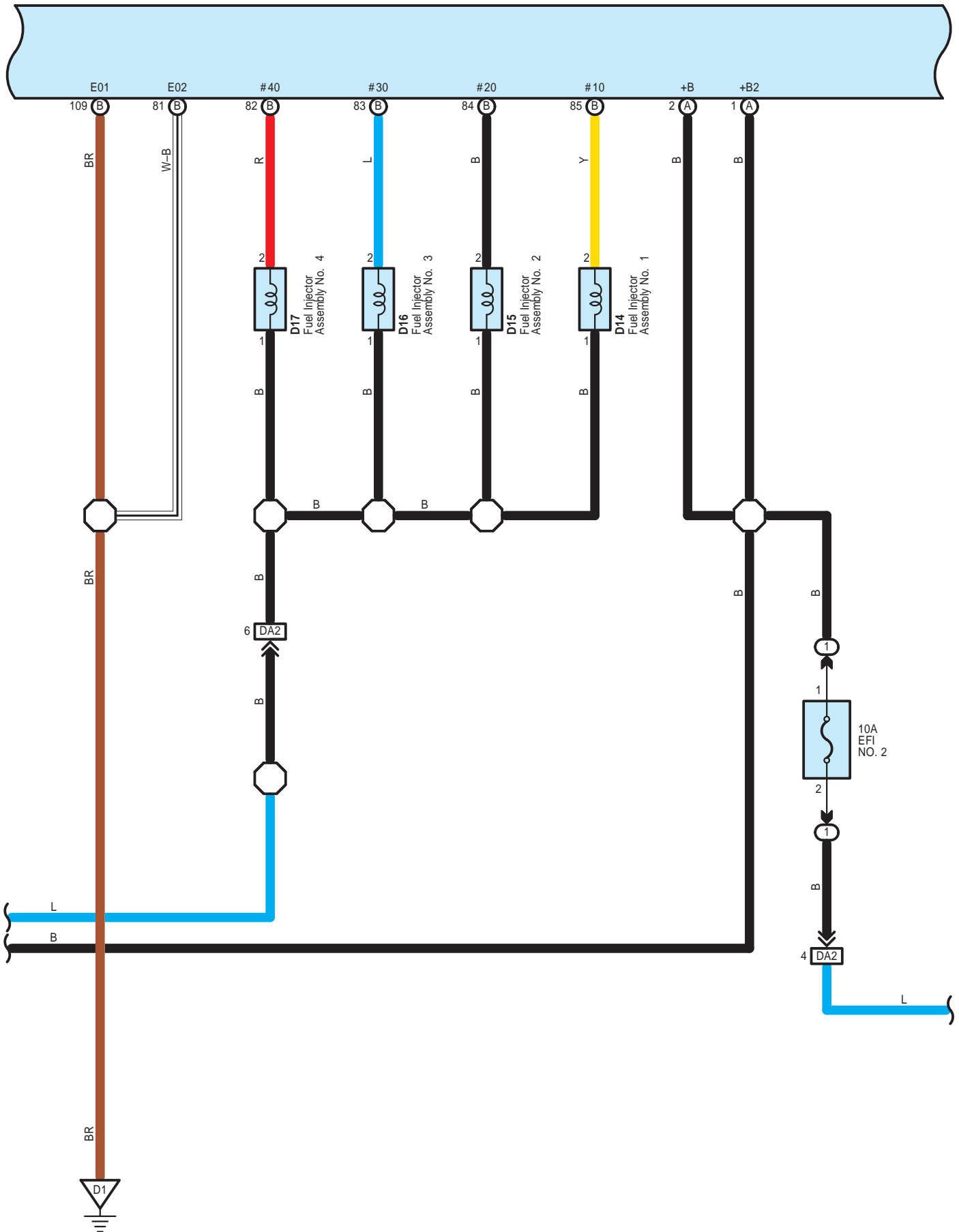

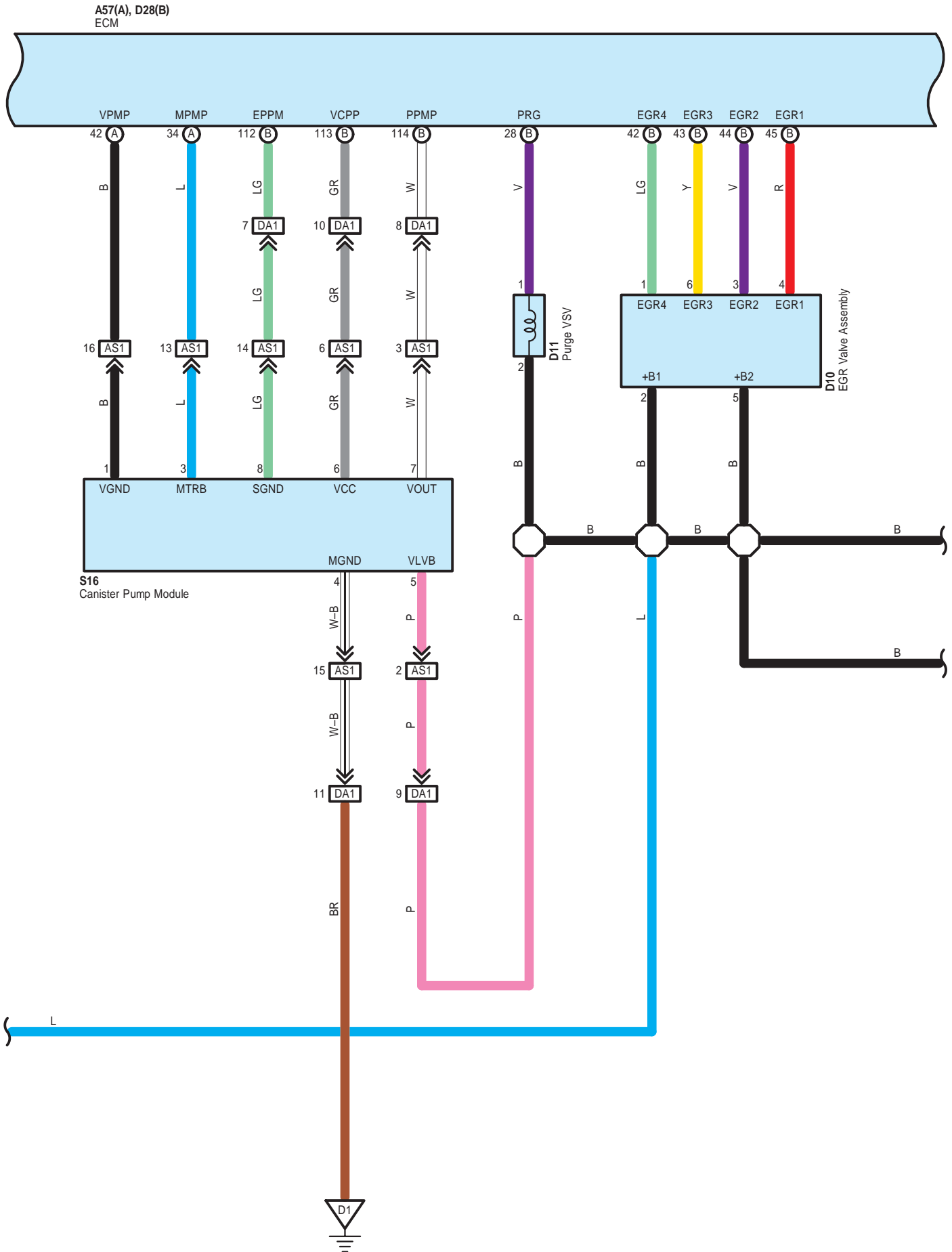



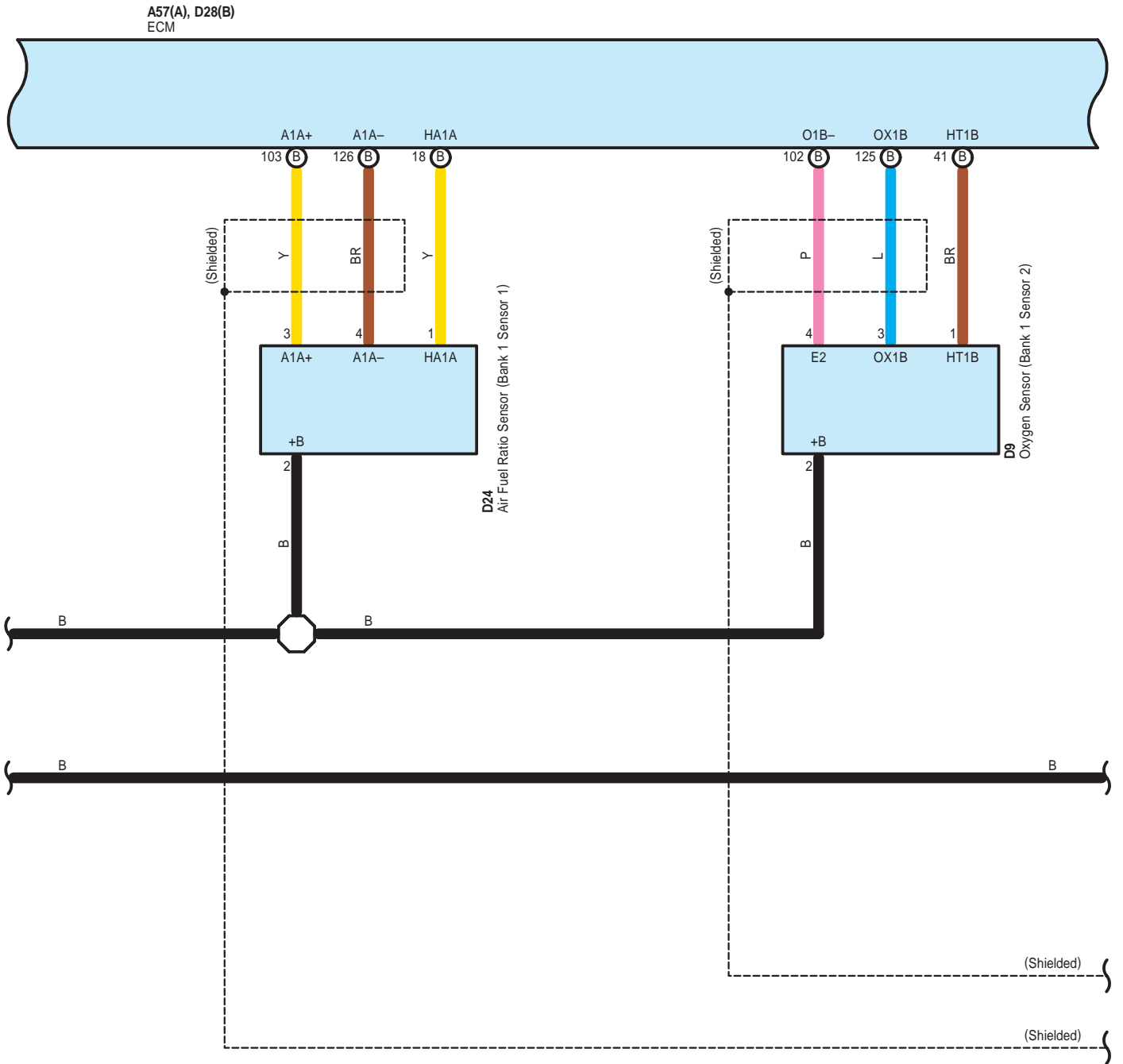

A57(A), D28(B)  
ECM

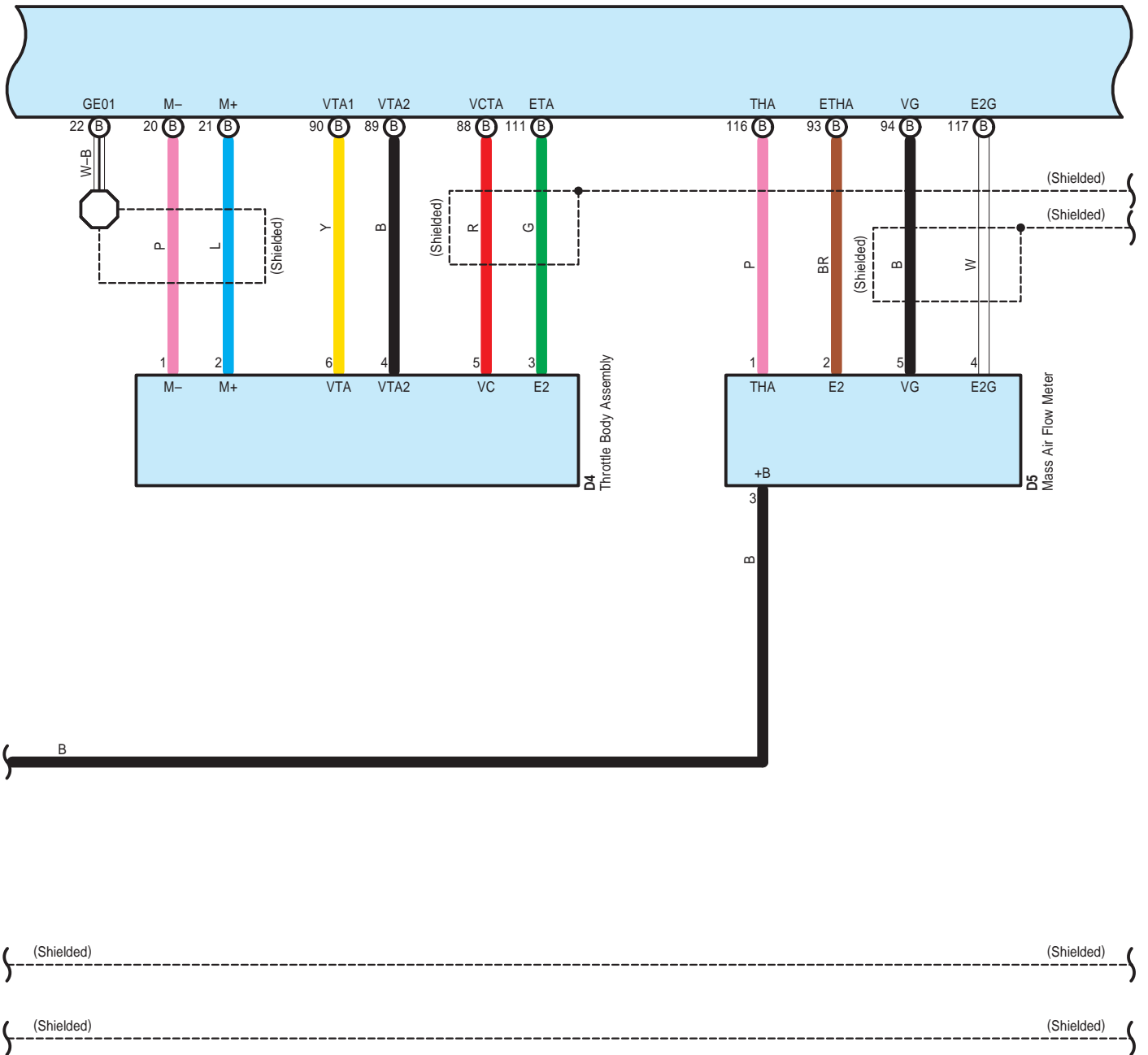

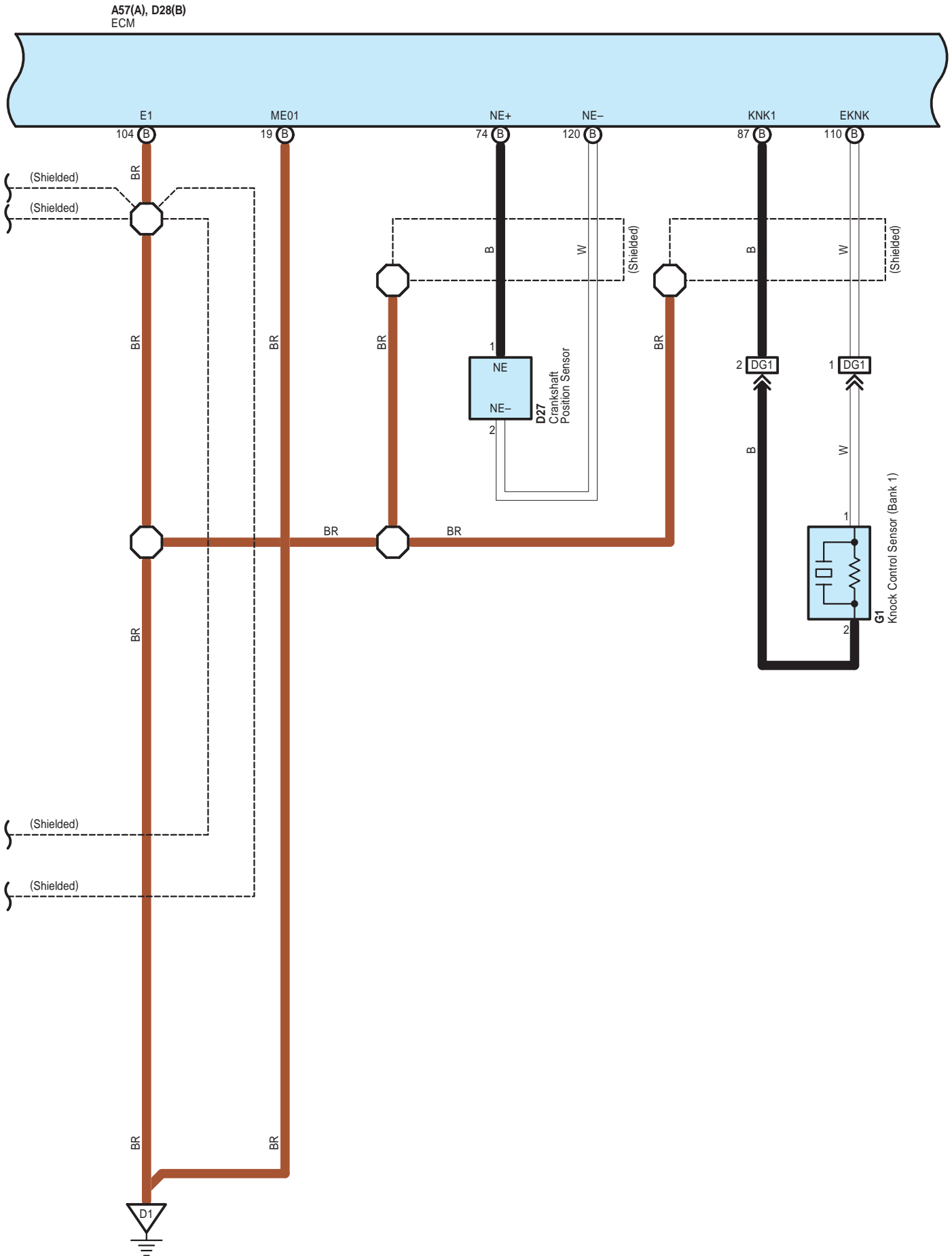

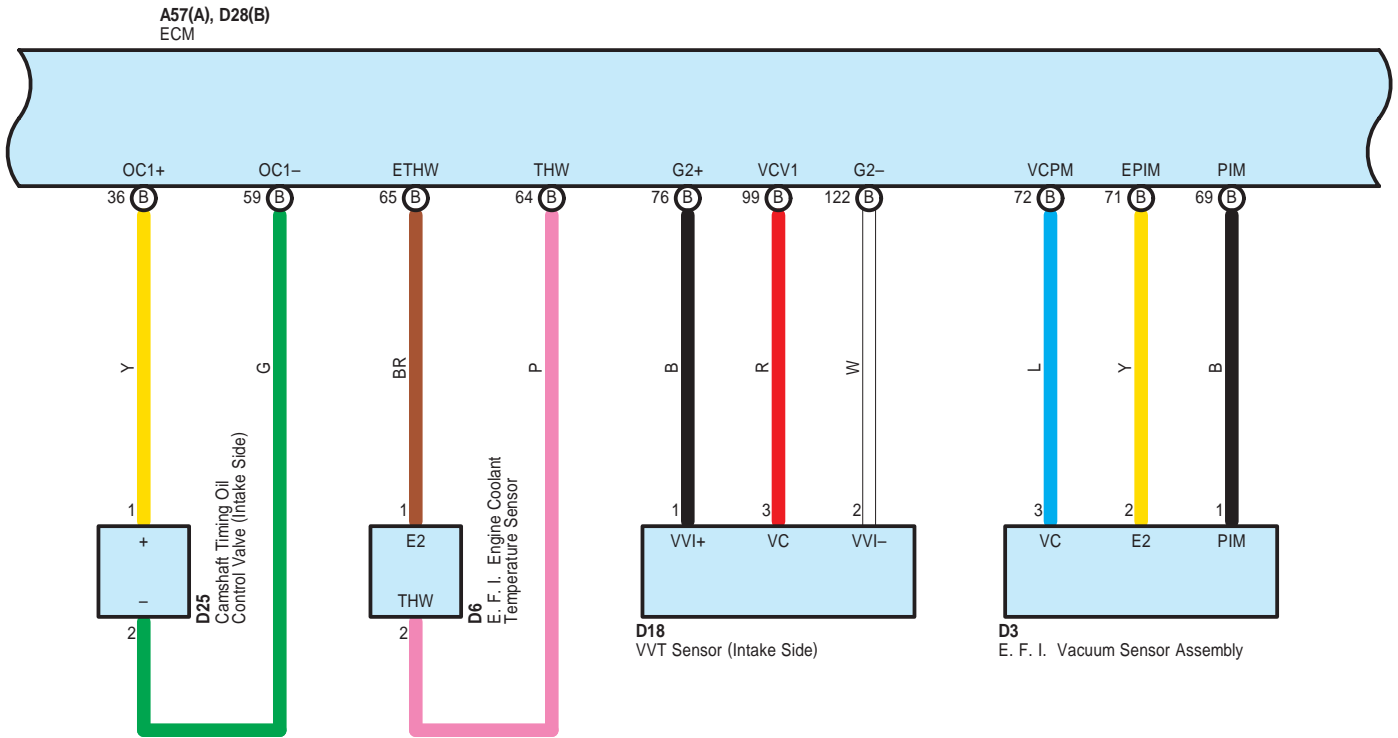

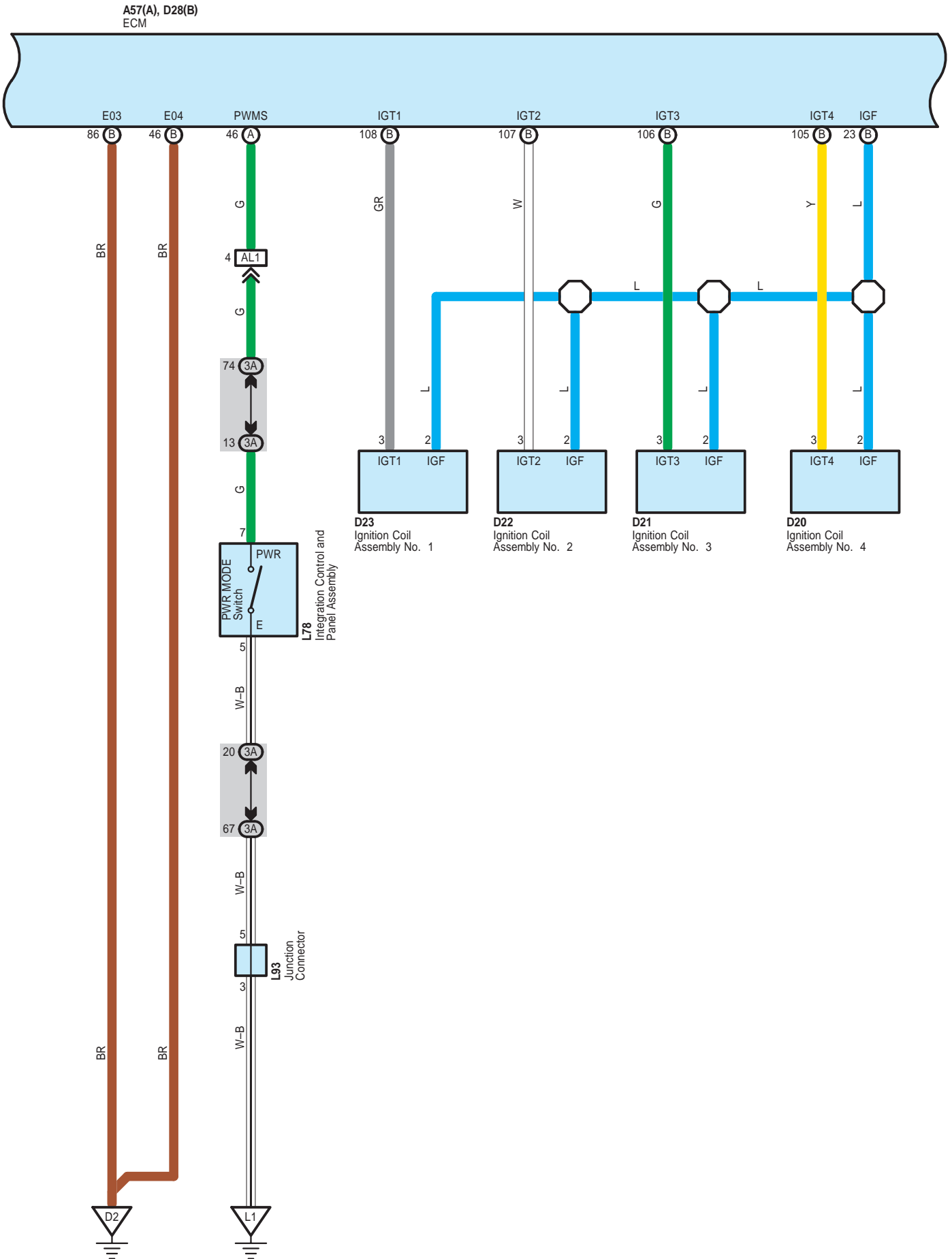

A57(A), D28(B)  
ECM

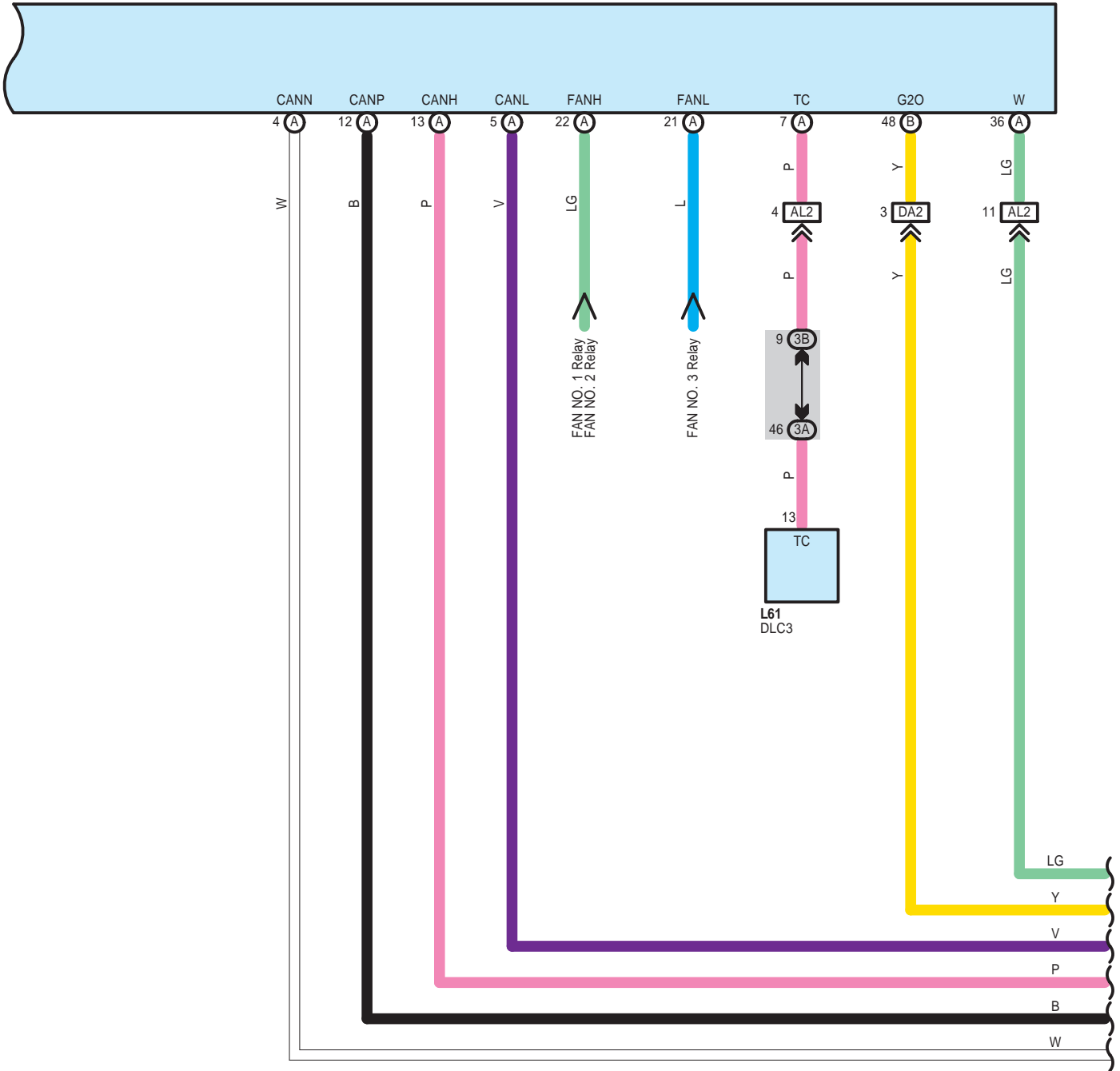

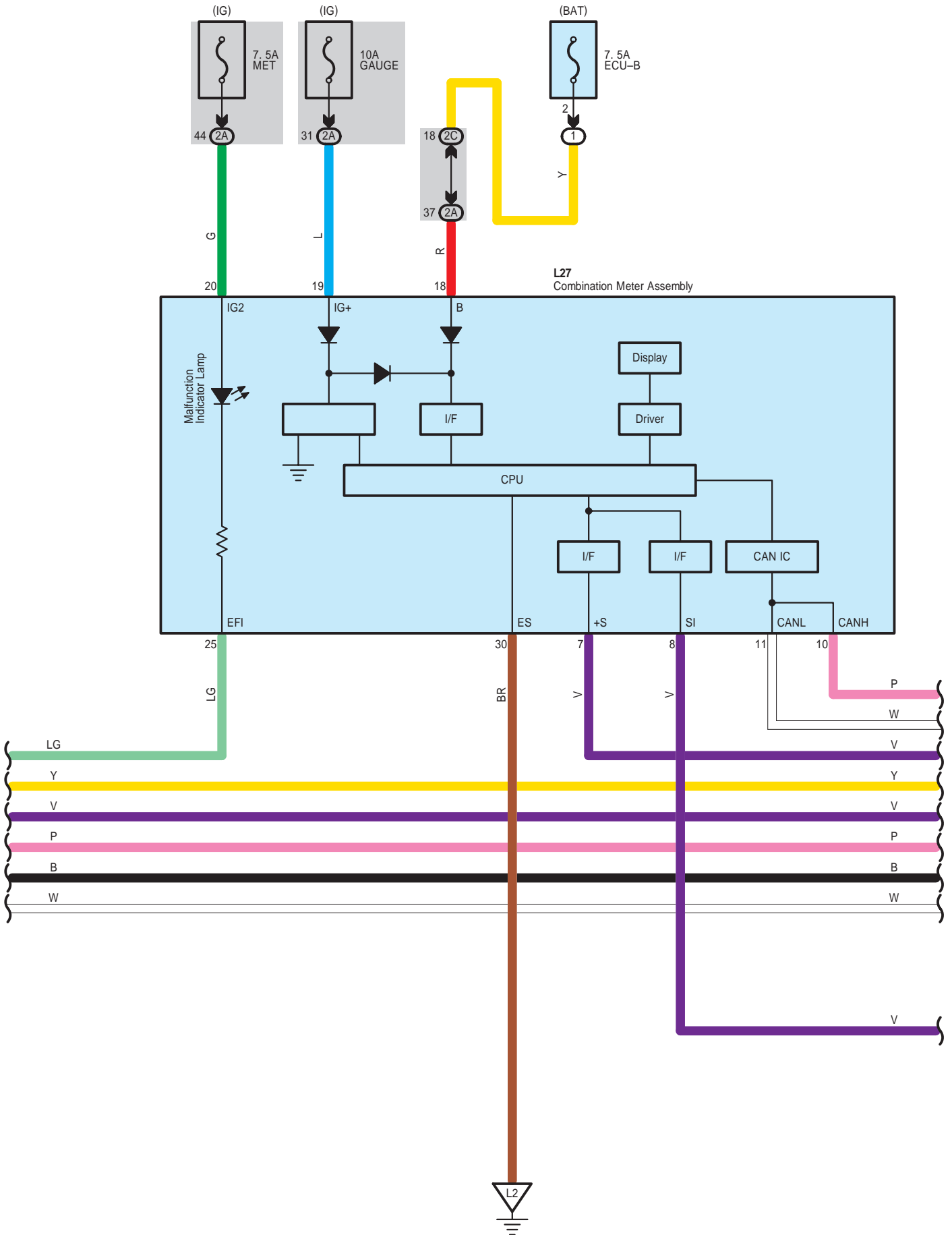

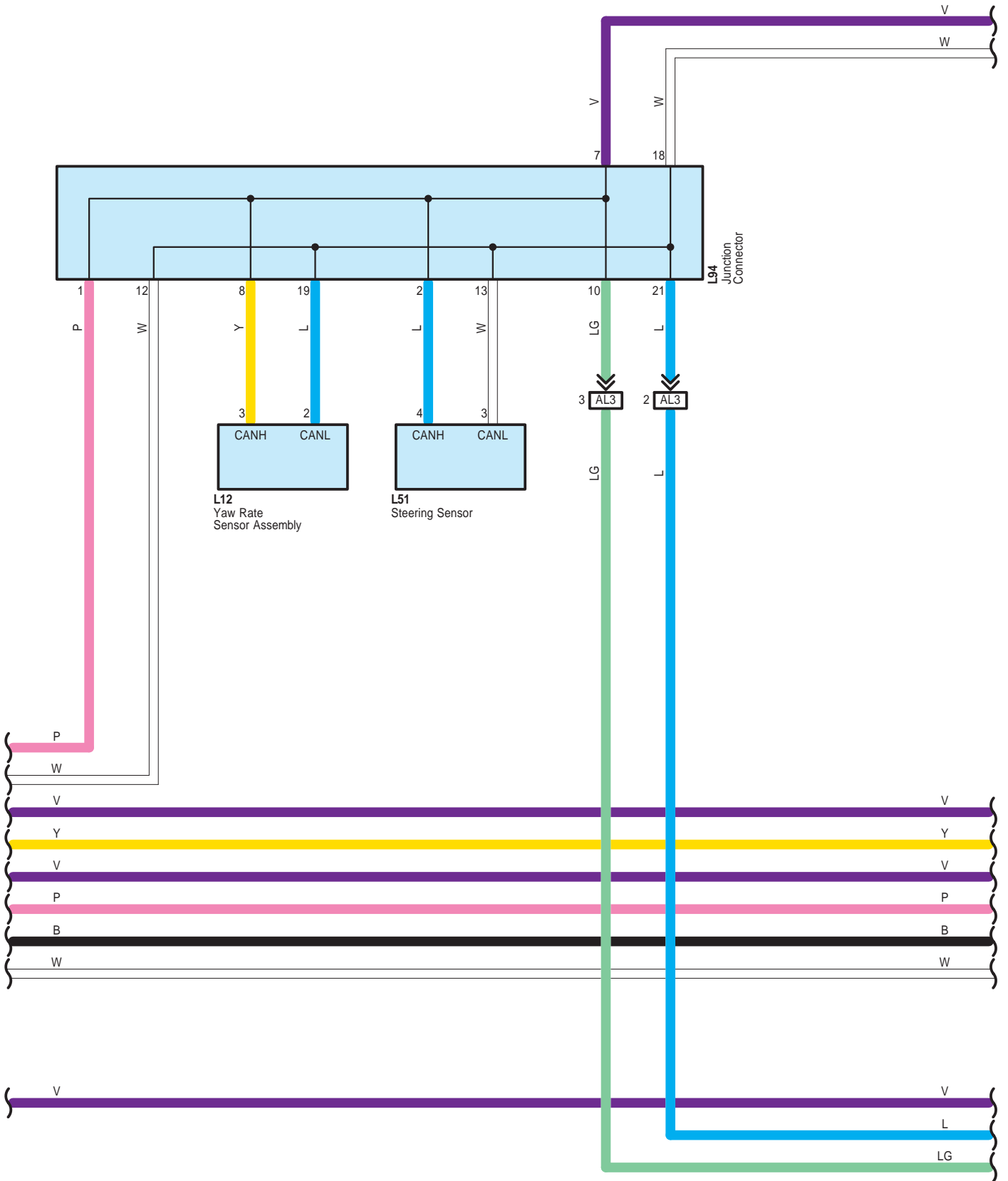





A21(A), A22(B), L5(C), L6(D)  
Power Management Control ECU

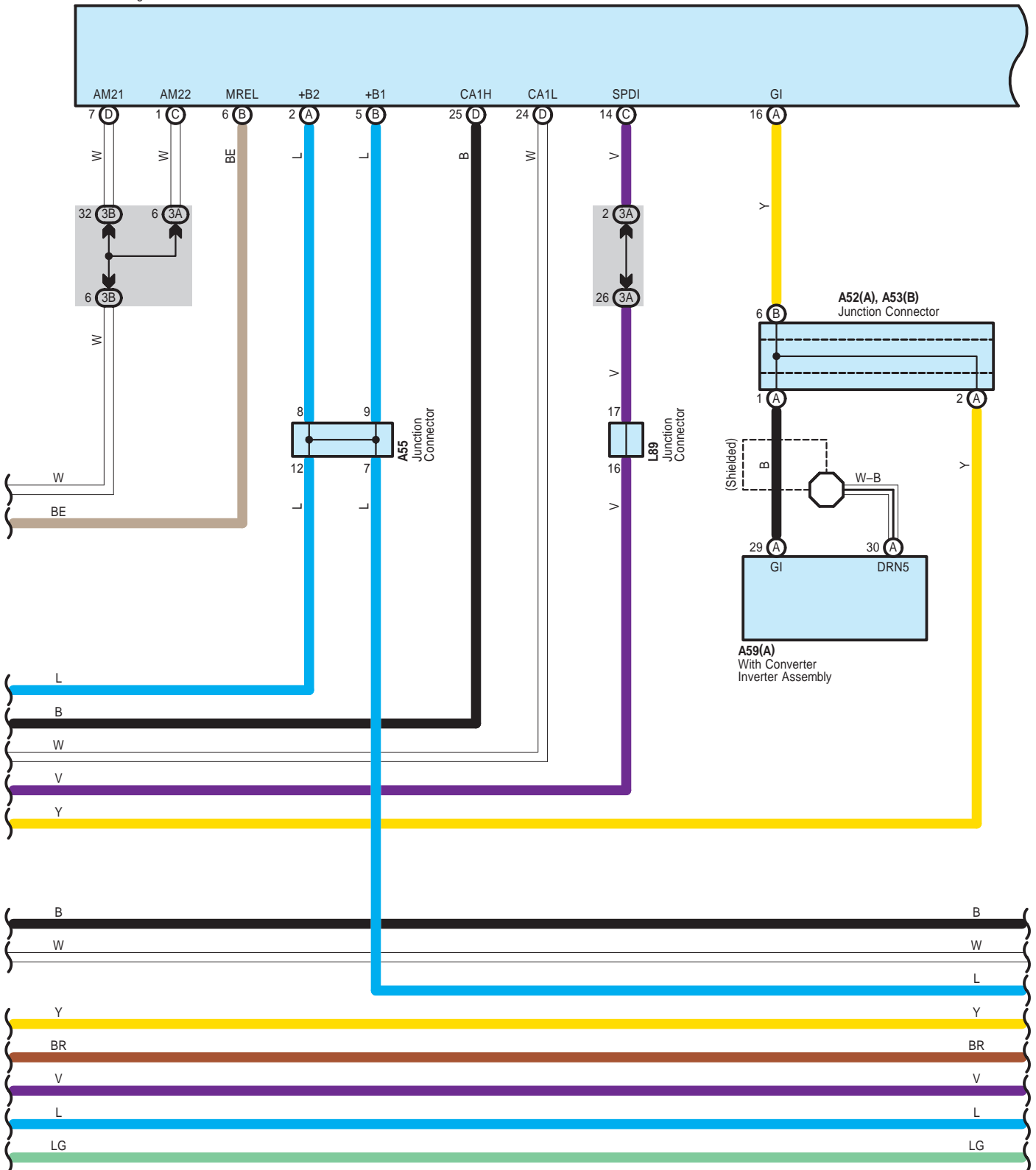

A21(A), A22(B), L5(C), L6(D)  
Power Management Control ECU

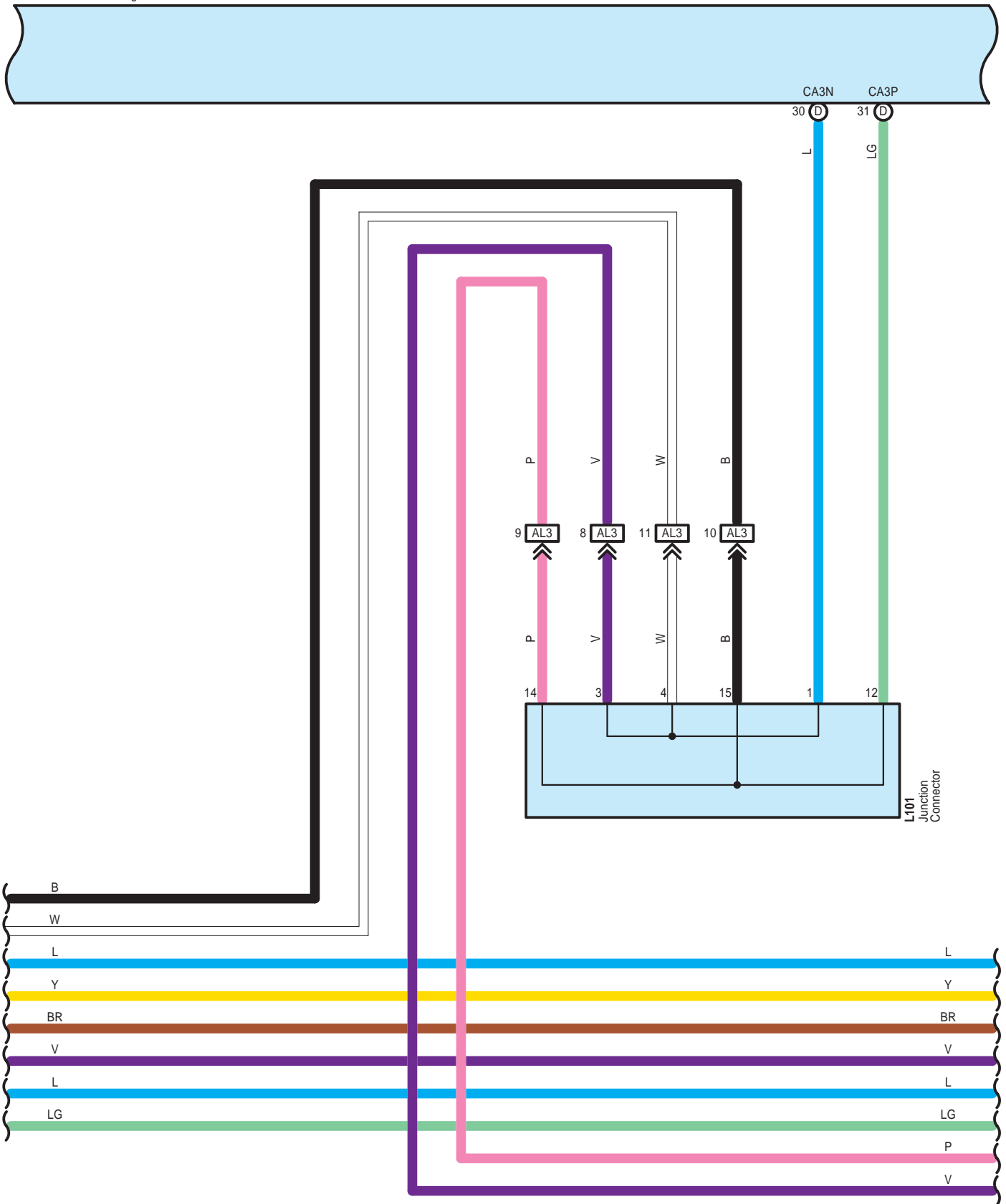

A21(A), A22(B), L5(C), L6(D)  
Power Management Control ECU

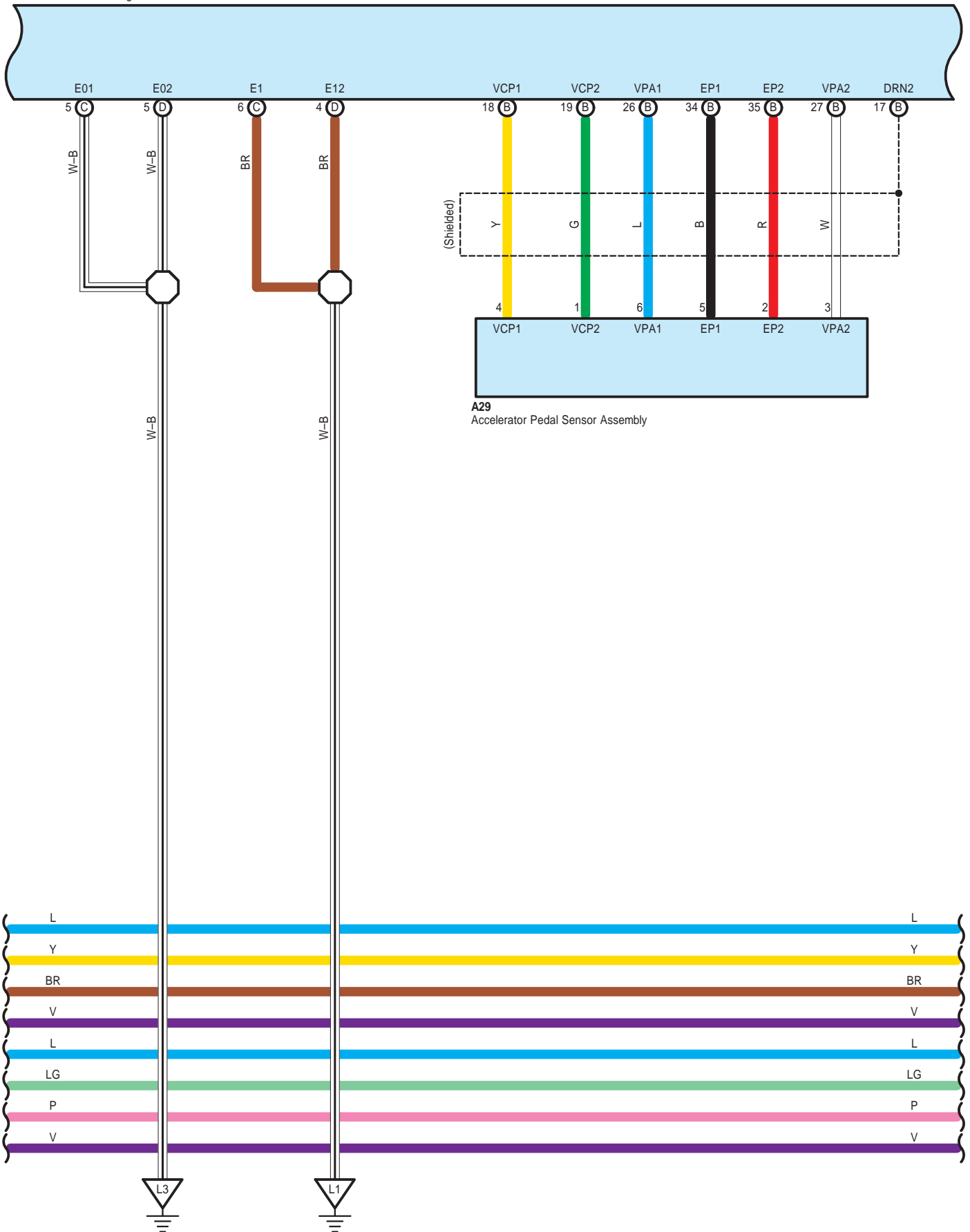

A21(A), A22(B), L5(C), L6(D)  
Power Management Control ECU

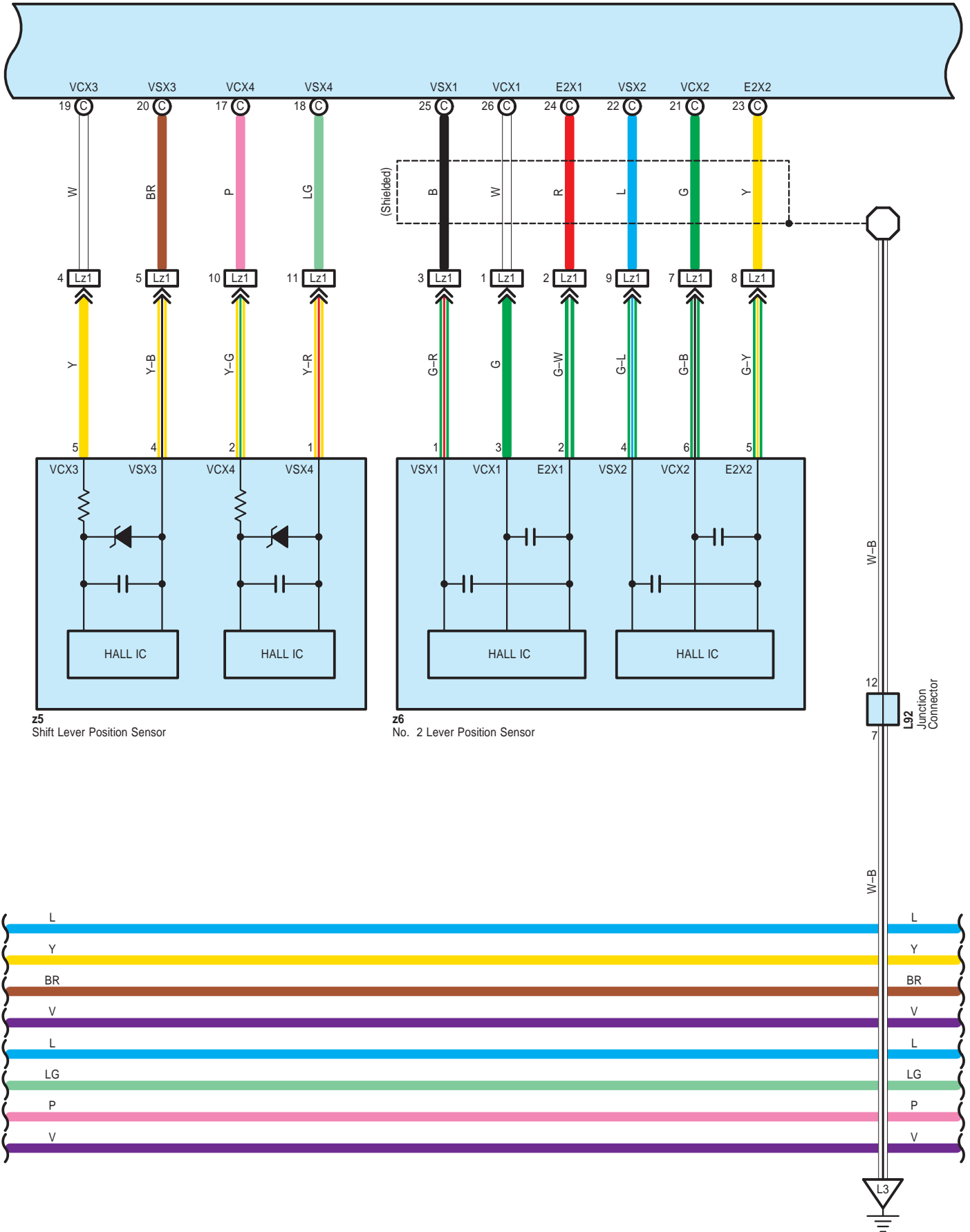

A21(A), A22(B), L5(C), L6(D)  
Power Management Control ECU

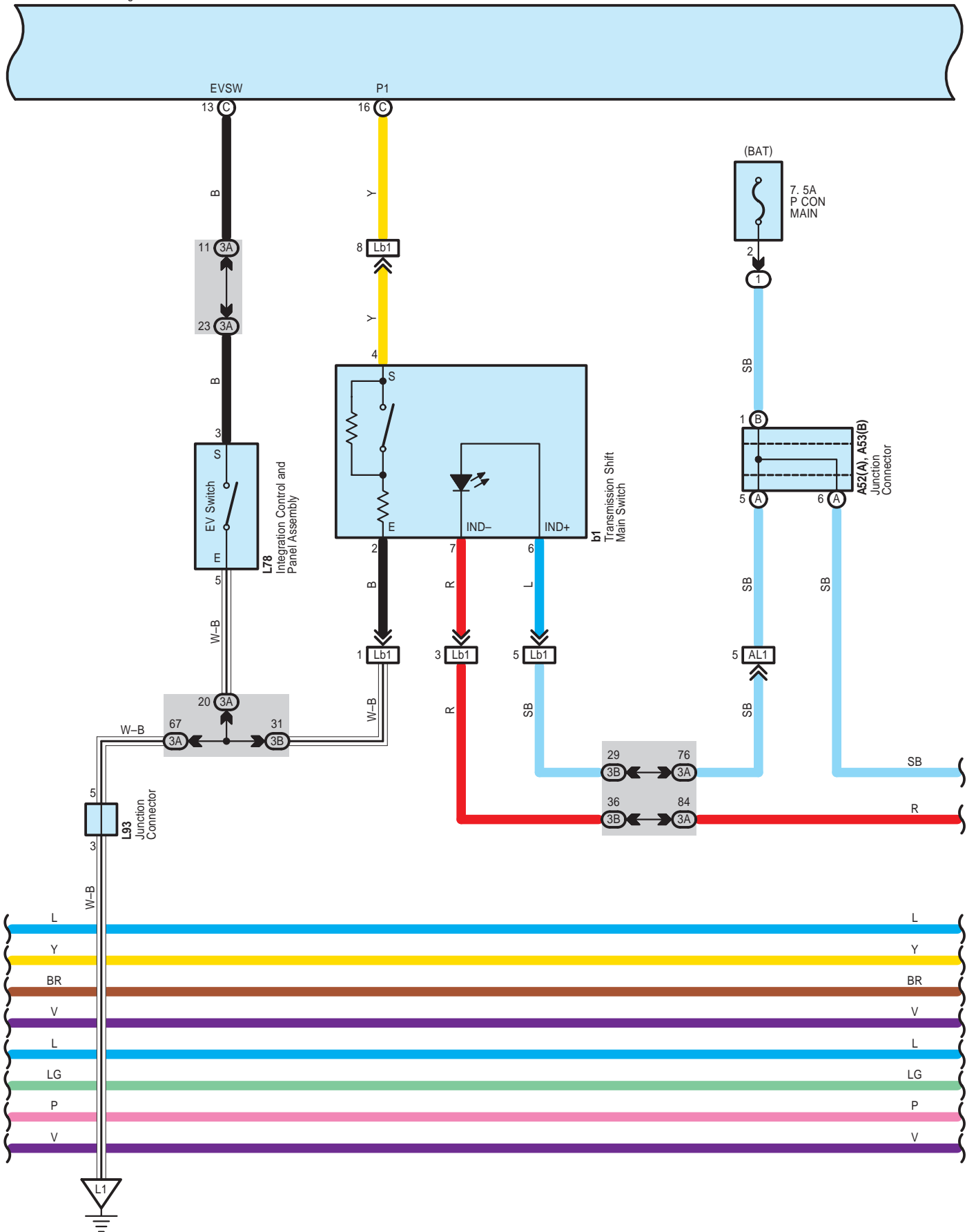







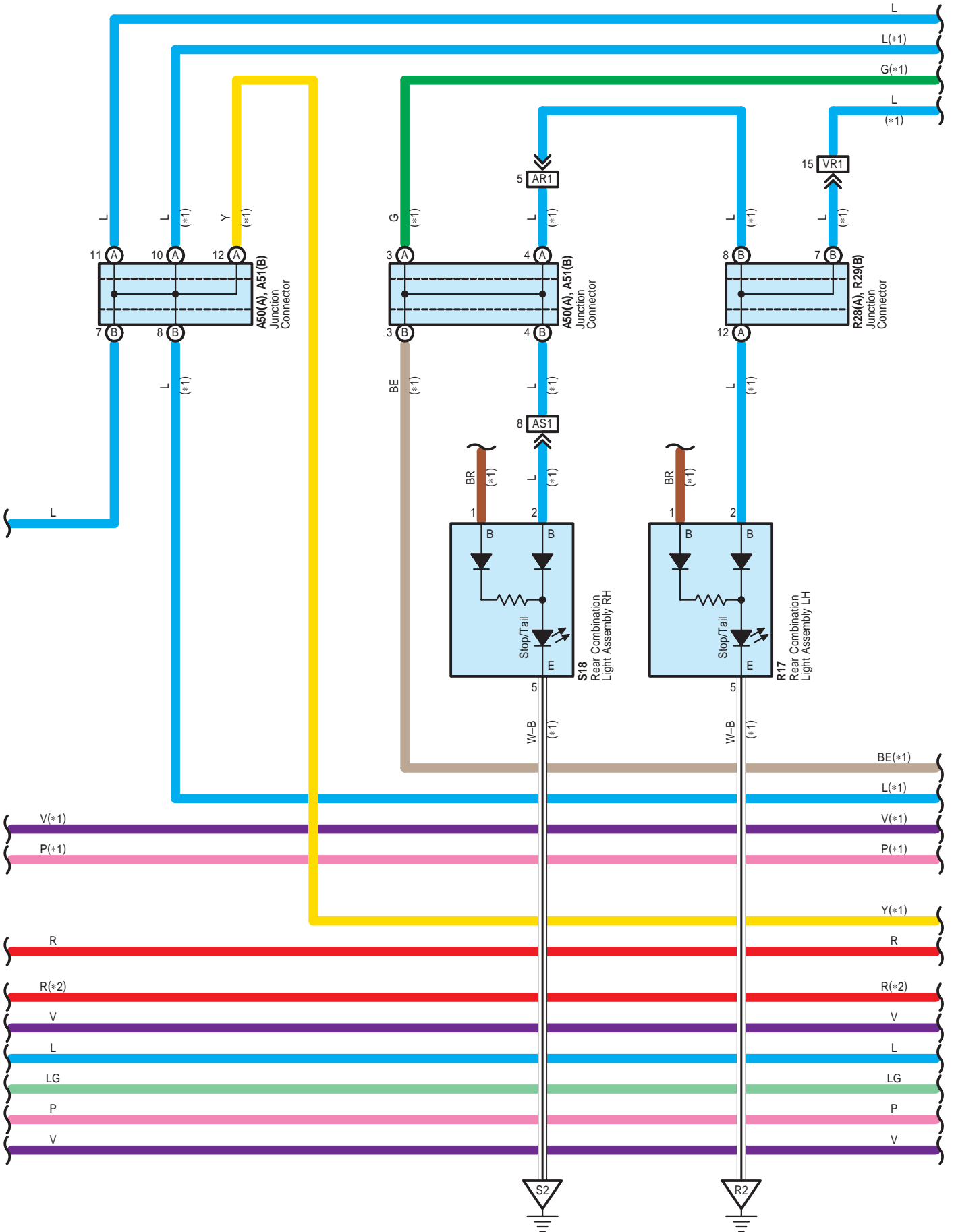

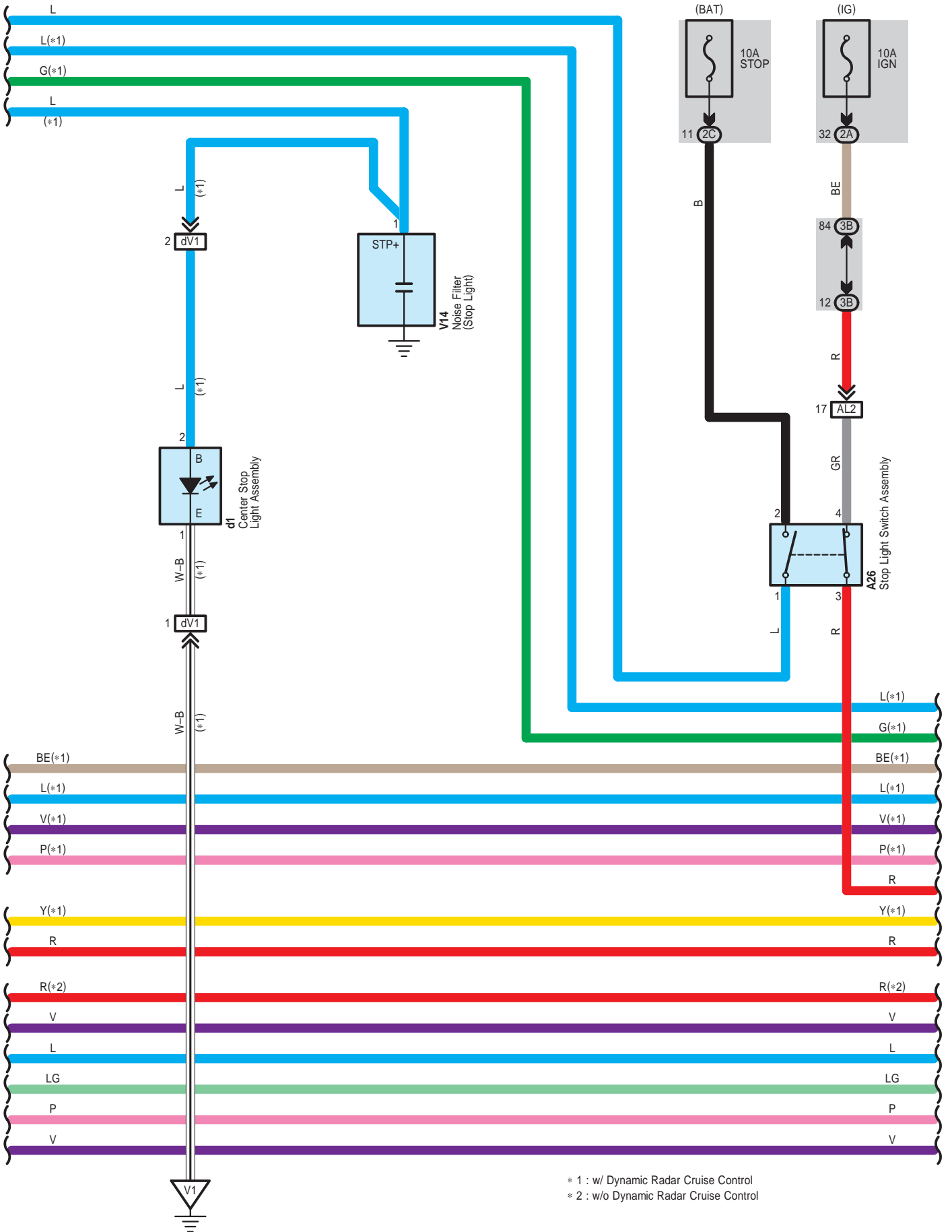

\* 1 : w/ Dynamic Radar Cruise Control  
 \* 2 : w/o Dynamic Radar Cruise Control

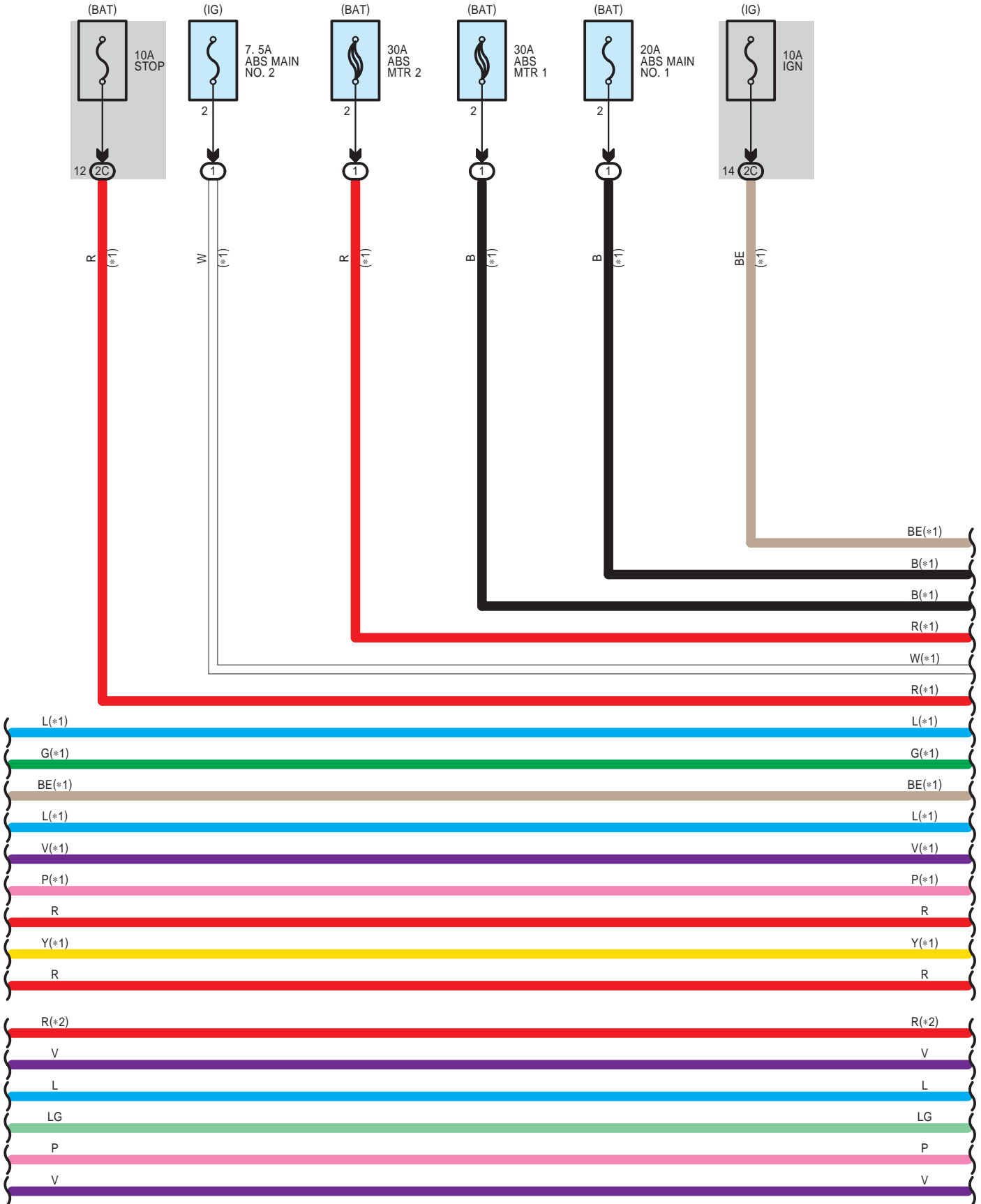



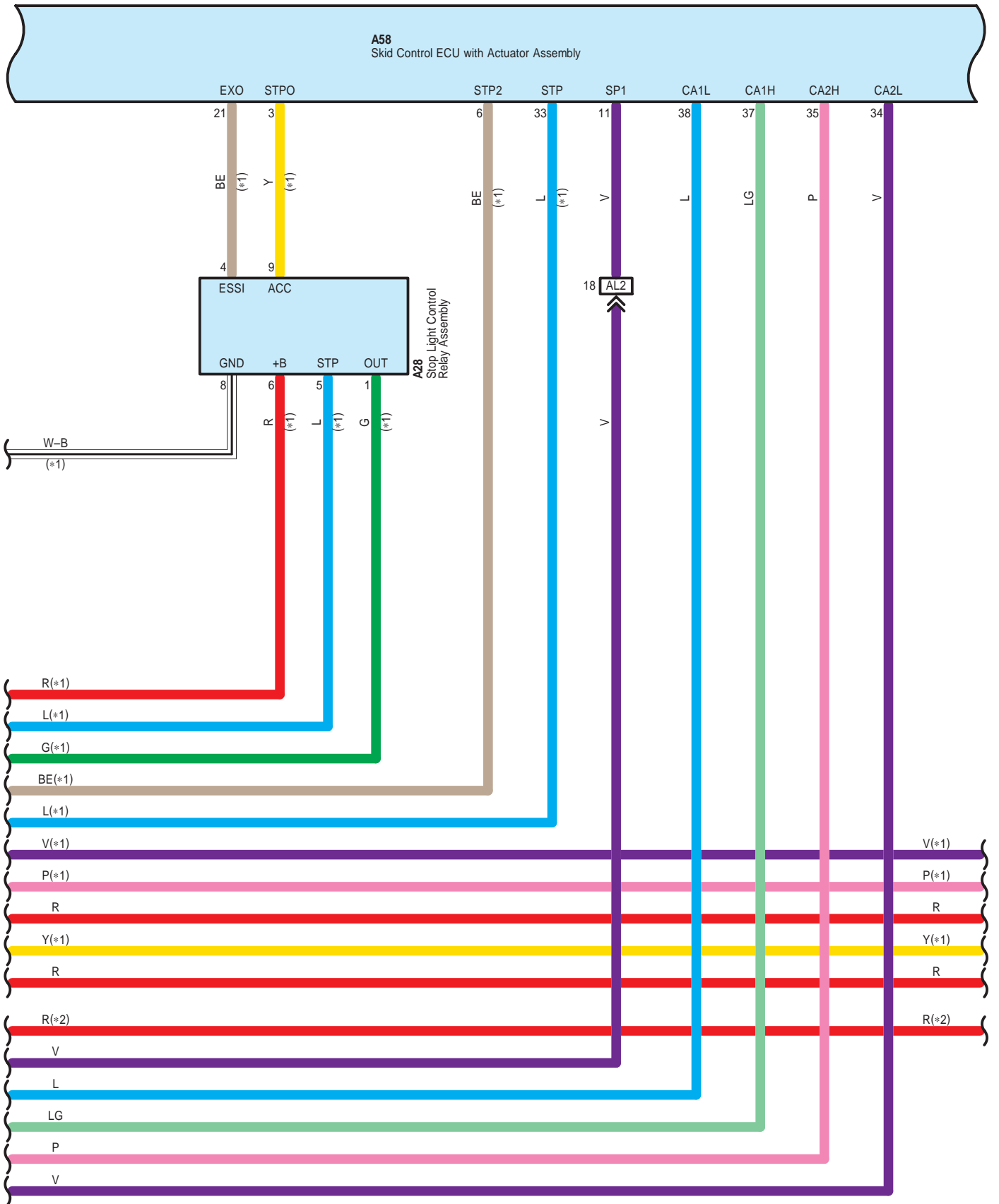

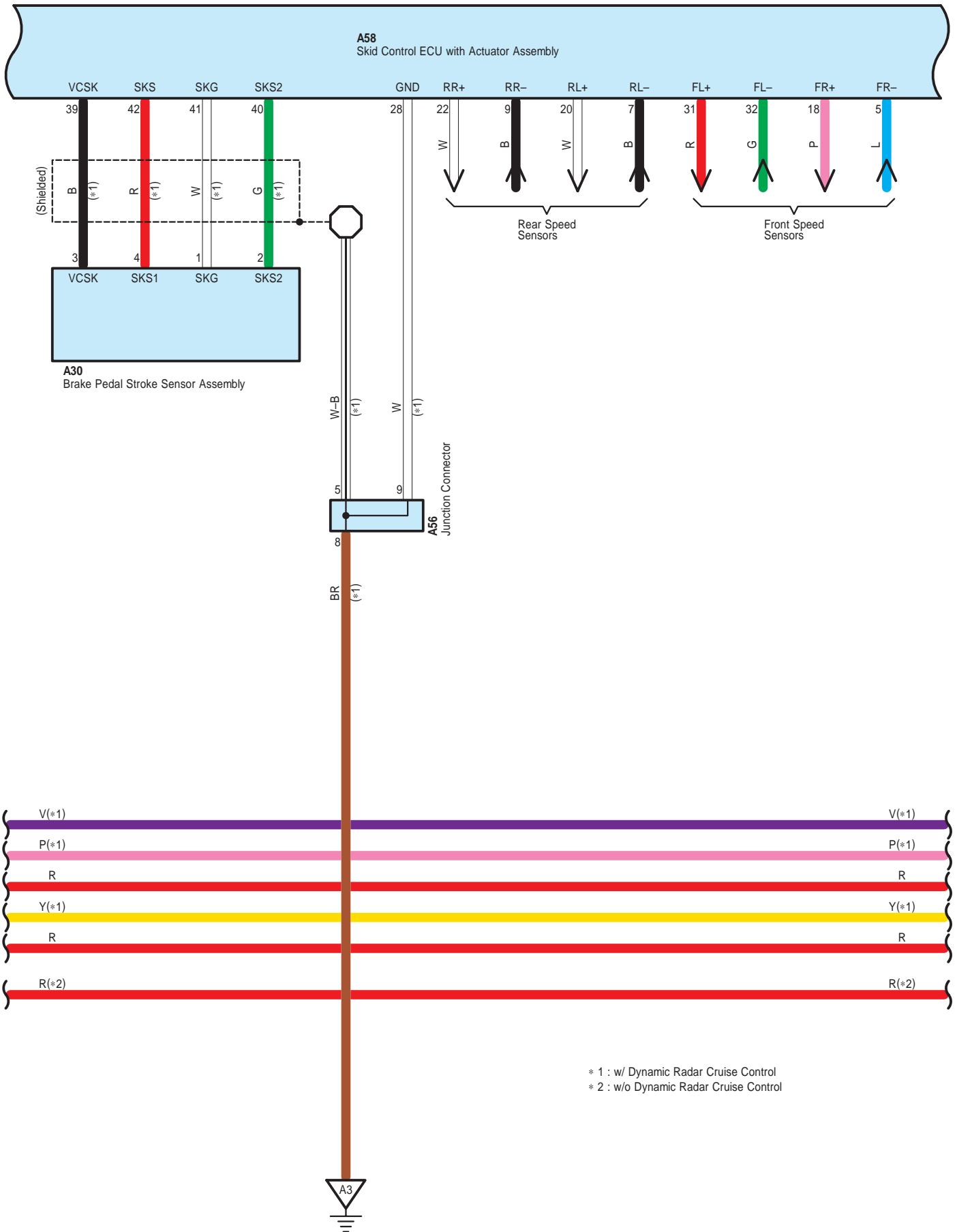

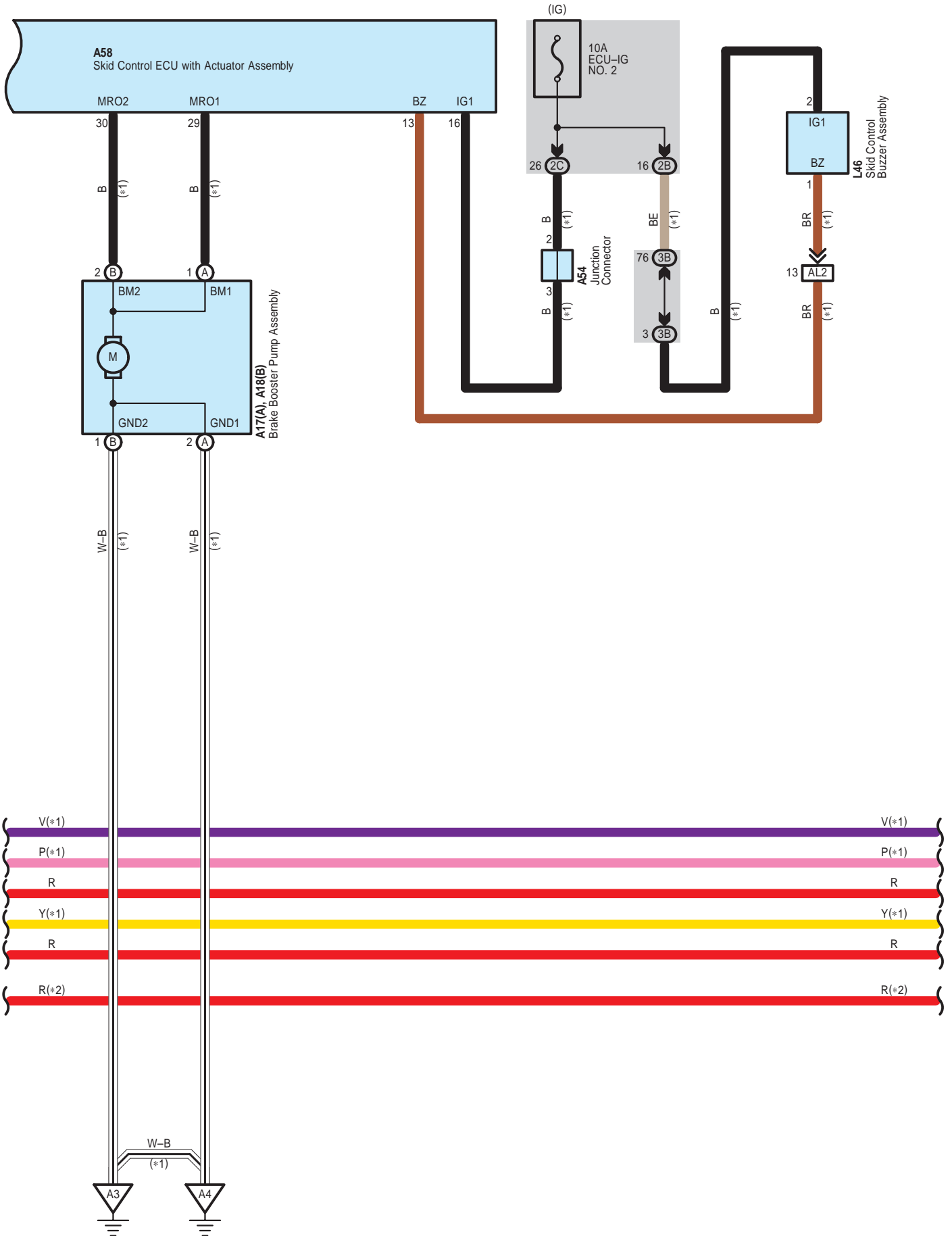

L60  
Driving Support ECU Assembly

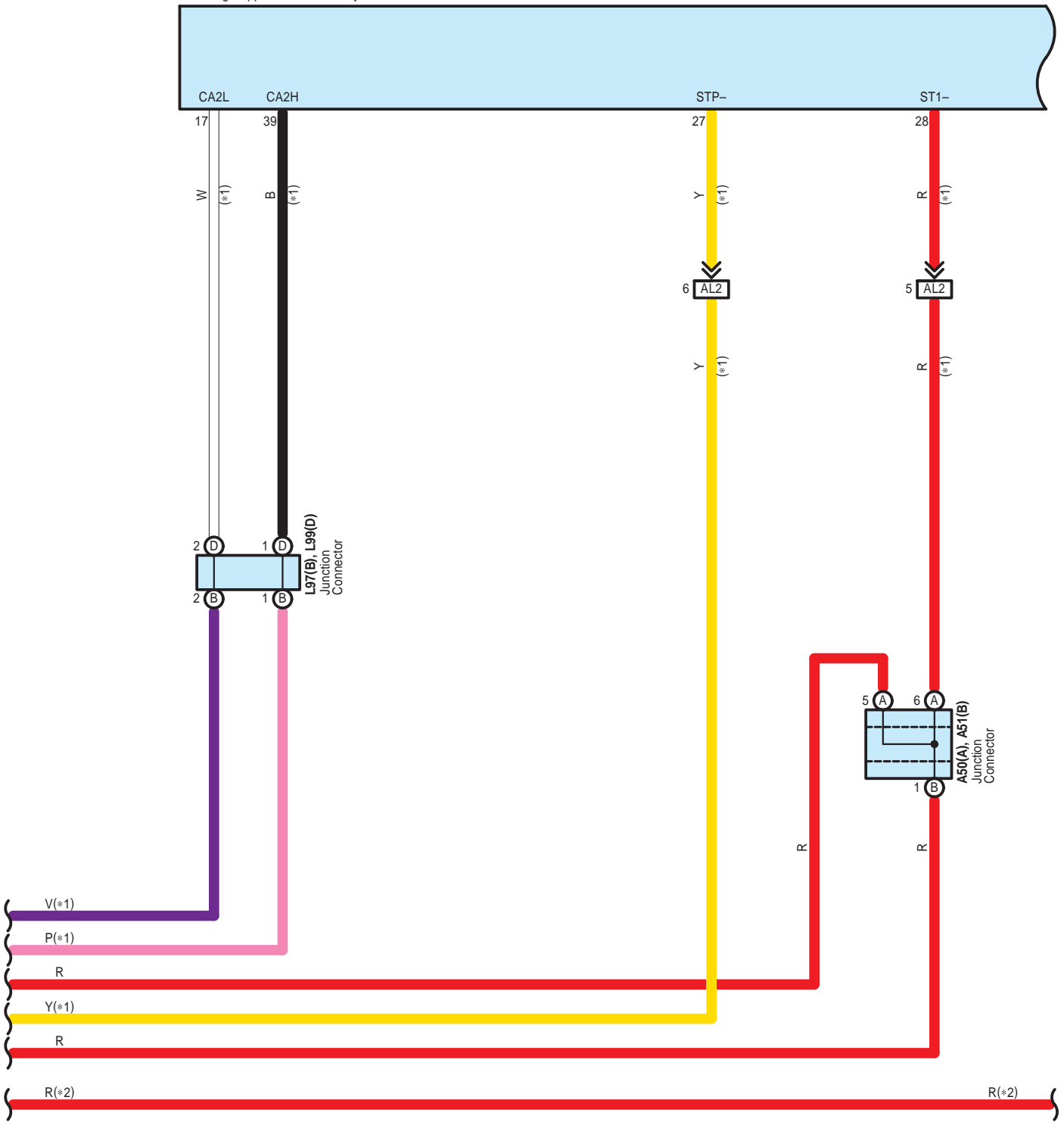

\* 1 : w/ Dynamic Radar Cruise Control  
 \* 2 : w/o Dynamic Radar Cruise Control





L60  
Driving Support ECU Assembly

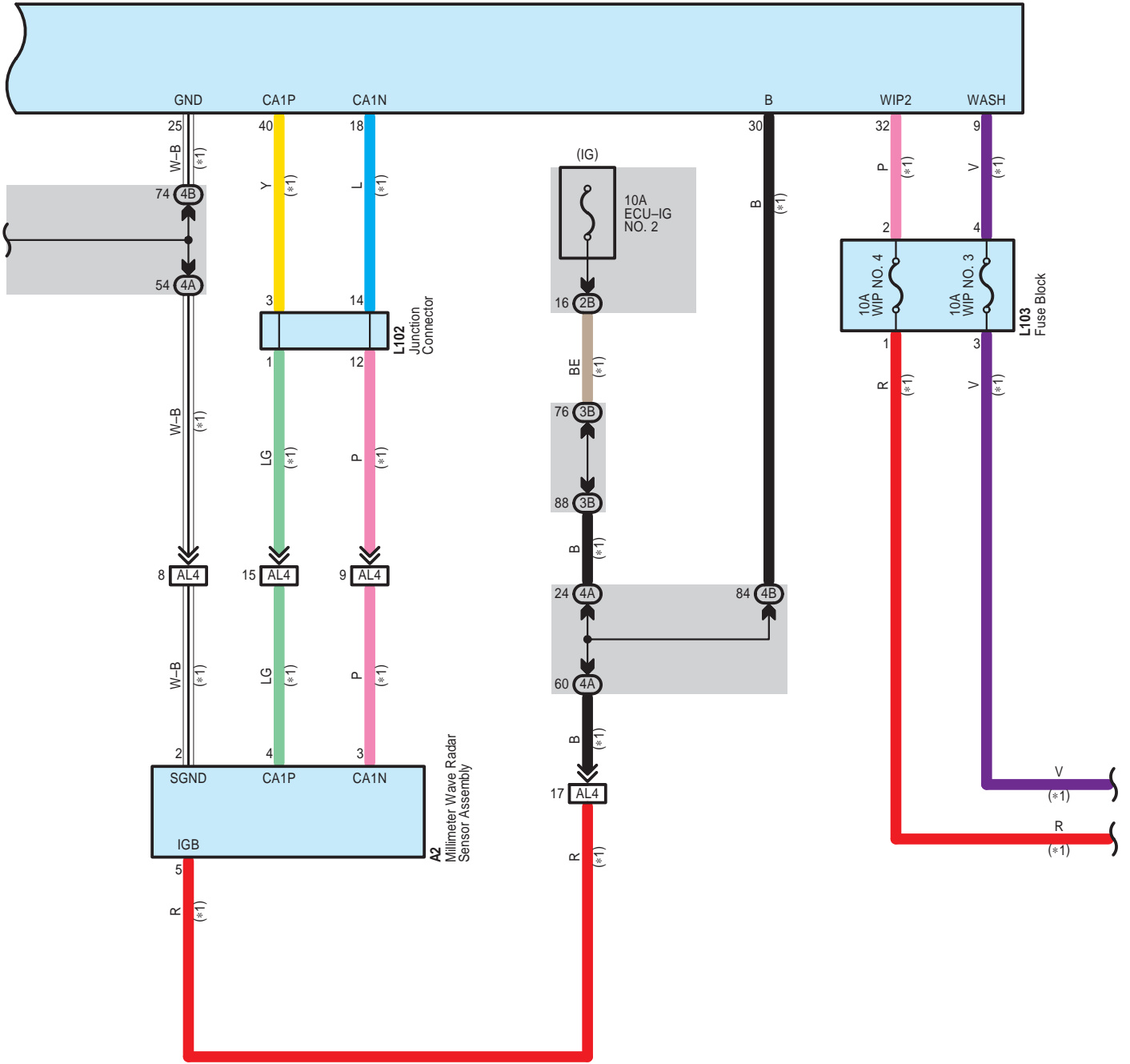

\* 1 : w/ Dynamic Radar Cruise Control  
\* 2 : w/o Dynamic Radar Cruise Control

\* 1 : w/ Dynamic Radar Cruise Control

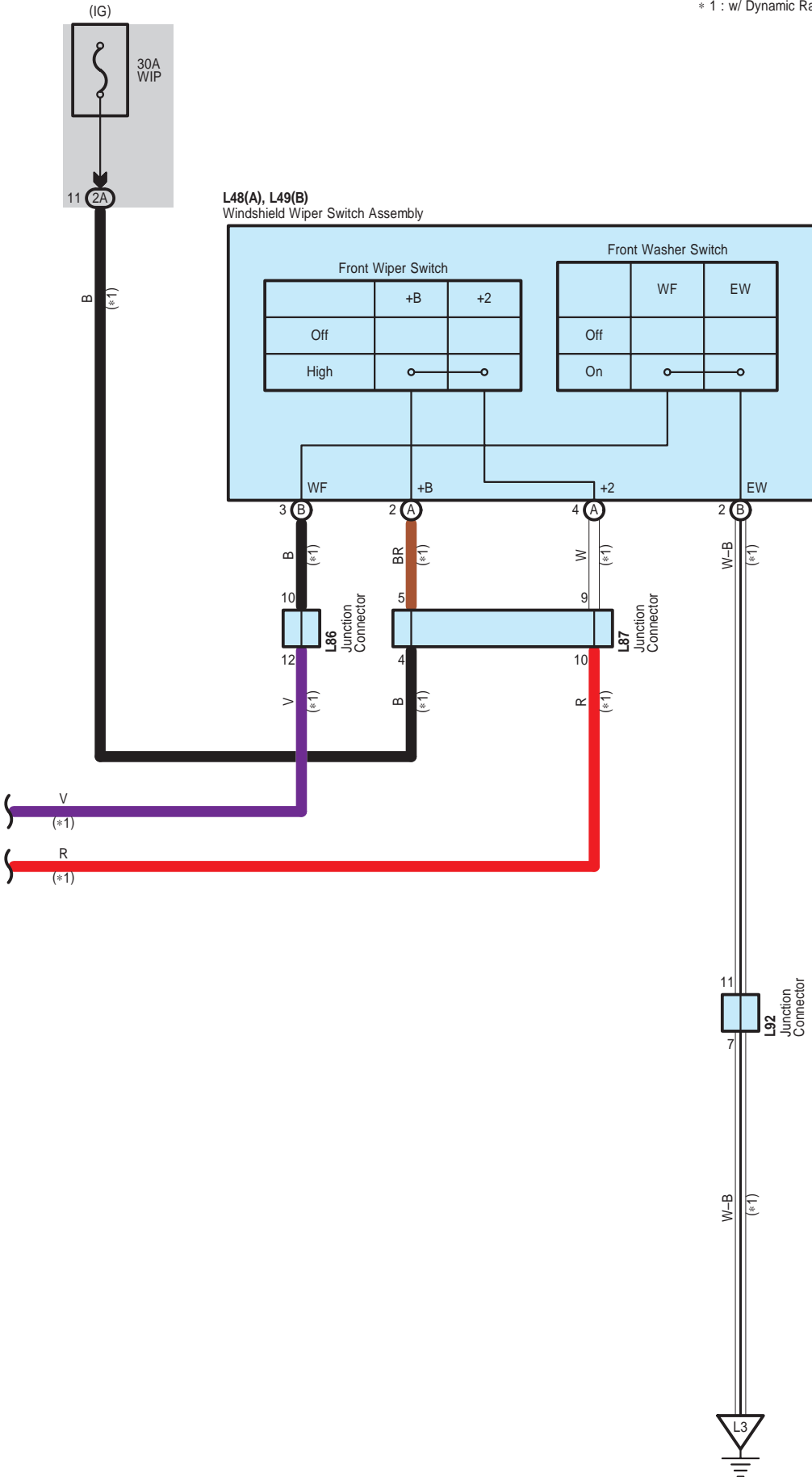

A 2  
Black



A 17  
Gray



A 18  
Black

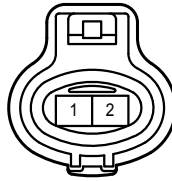

A 21  
Gray

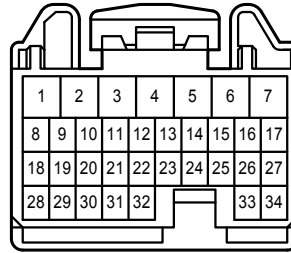

A 22  
Gray

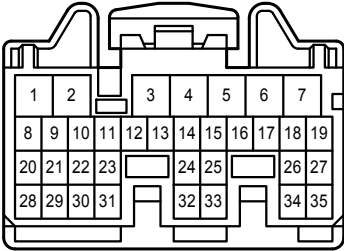

A 23  
White

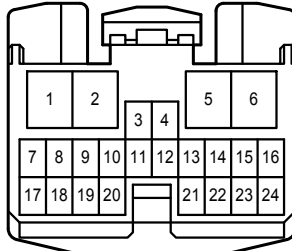

A 24  
White

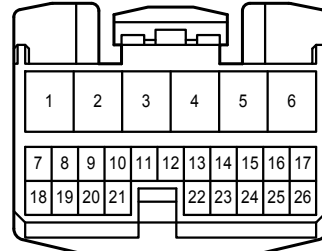

A 26  
White

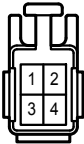

A 28  
Black

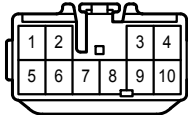

A 29  
Black

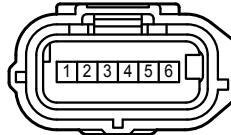

A 30  
Black

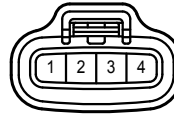

A 32  
Black

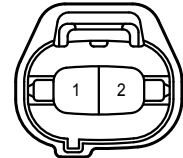

A 50  
White

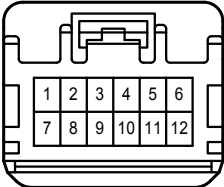

A 51  
White

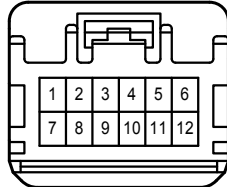

A 52  
Black

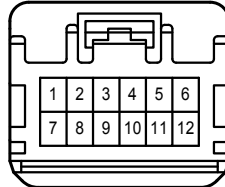

A 53  
Black

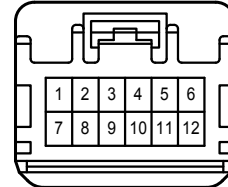

A 54  
Black

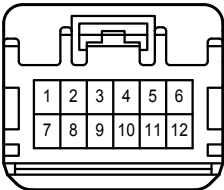

A 55  
Black

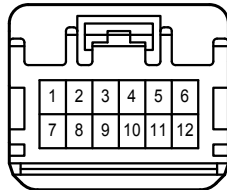

A 56  
White

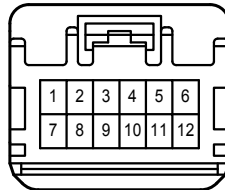

A 57  
Black

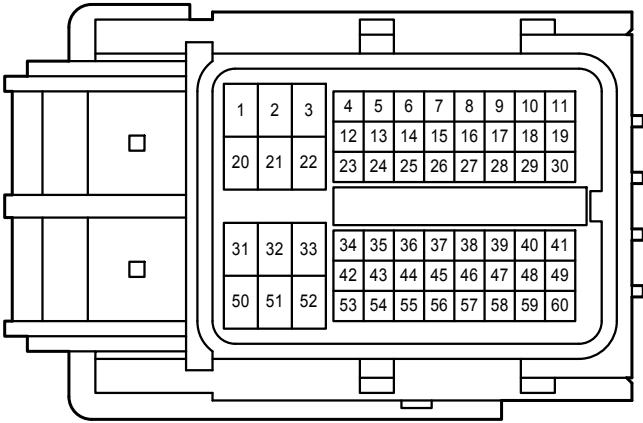

A 58  
Gray

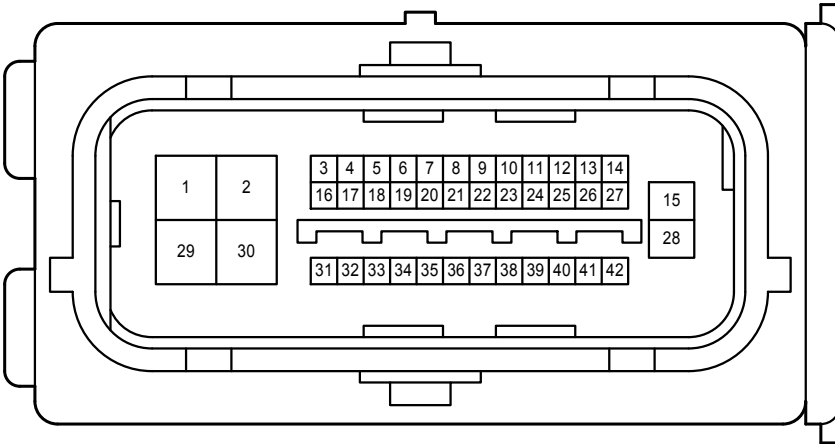

A 59  
Black

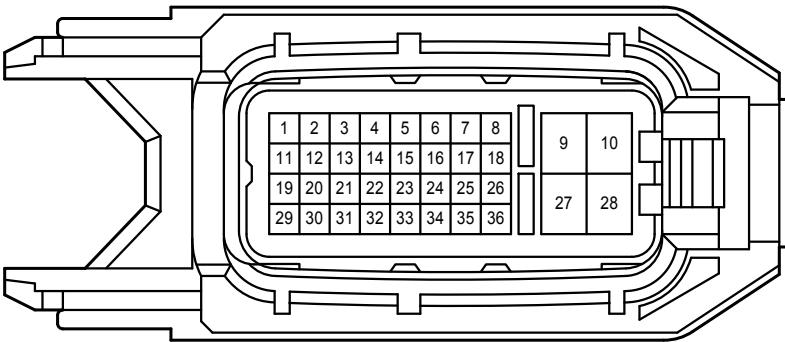

D 2  
Black

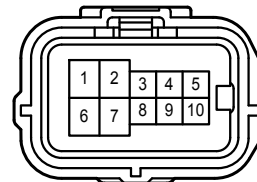

D 3  
Black

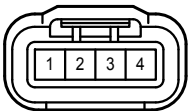

D 4  
Black

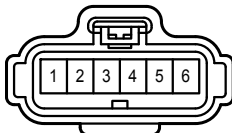

D 5  
Black



D 6  
Black





L 27  
White

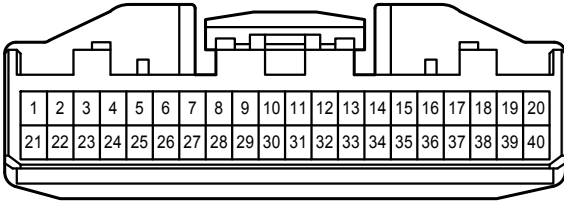

L 46  
Blue

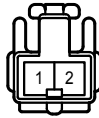

L 48  
White

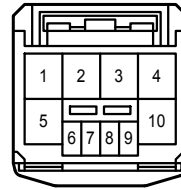

L 49  
White

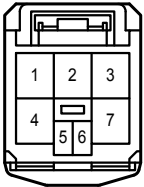

L 51  
White

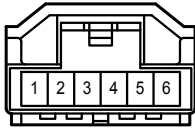

L 52  
Black

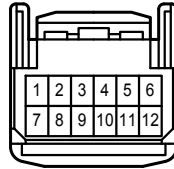

L 60  
White

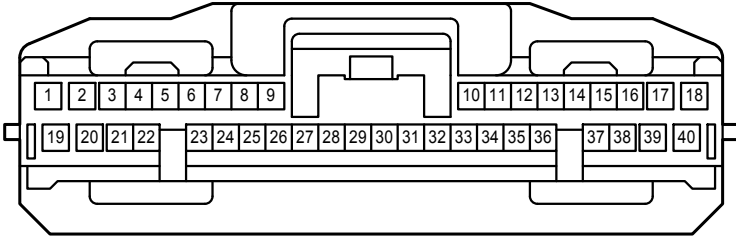

L 61  
White

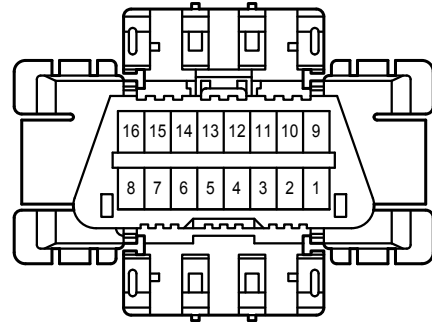

L 78  
Black

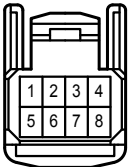

L 86  
Black

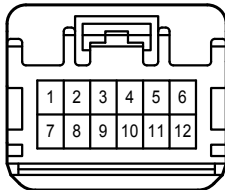

L 87  
Black

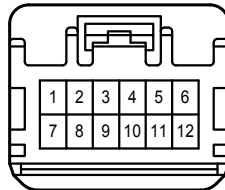

L 89  
Black

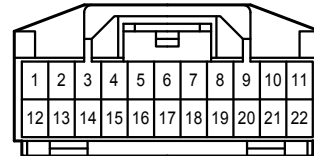

L 92  
White

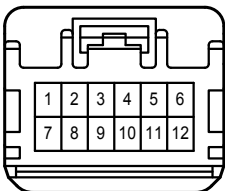

L 93  
White

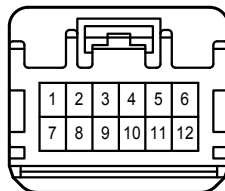

L 94  
White

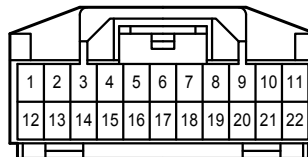

L 95  
White

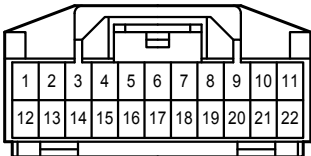

L 97  
White

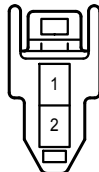

L 99  
White

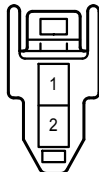

L 101  
Black

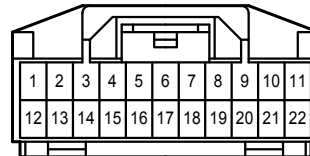

L102  
Blue

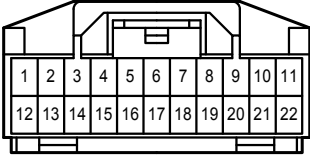

L103  
White

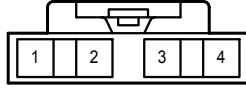

R 11  
Dark Gray

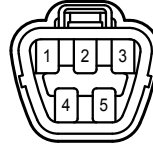

R 17  
White



R 28  
White

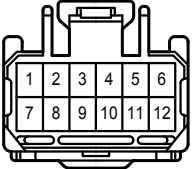

R 29  
White

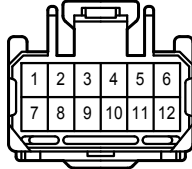

R 31  
White

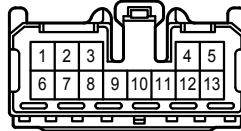

S 16  
Gray

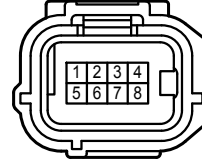

S 18  
White

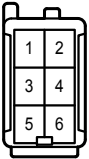

V 14  
Black

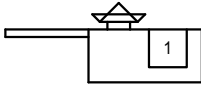

b 1  
White

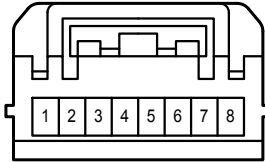

d 1  
White



z 5  
White

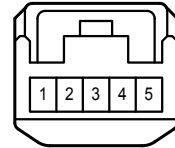

z 6  
White

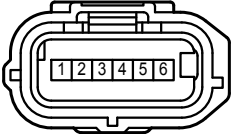

z 9  
Black

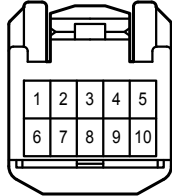

z 10  
Black

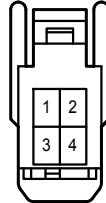

1A  
White

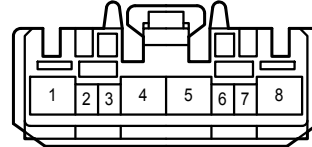

1B  
White

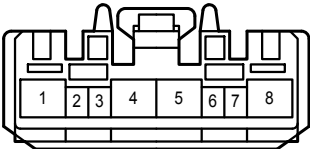

1G  
White

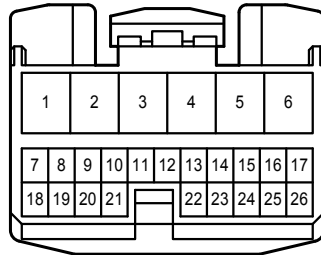

1H  
White

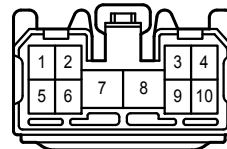

2A  
White

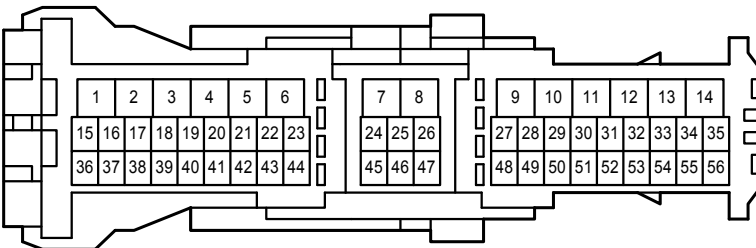



2B

White

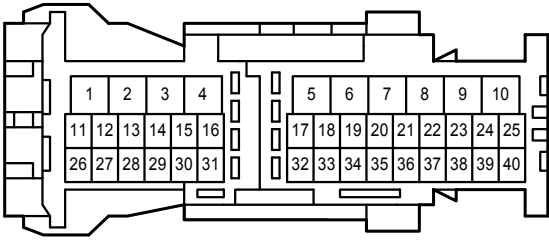

2C

White

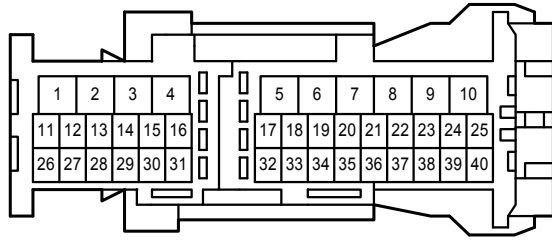

3A

White

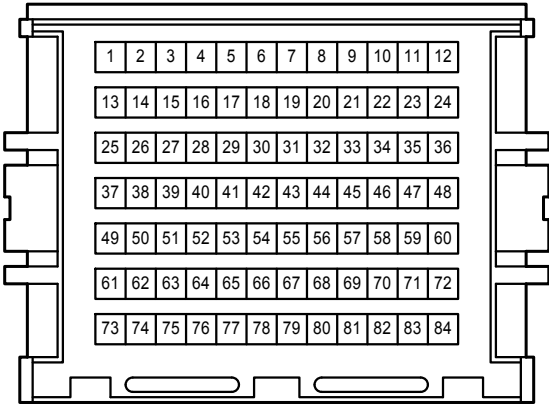

3B

White

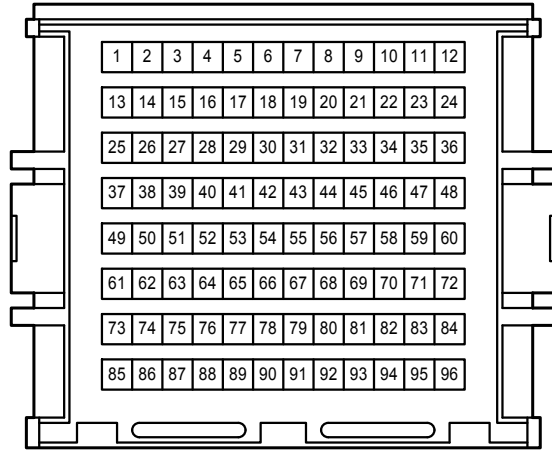

4A

White

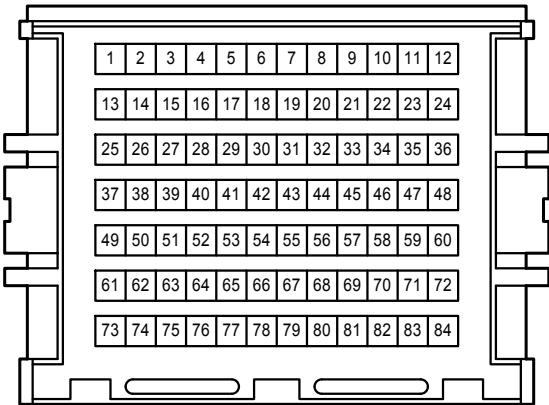

4B

White

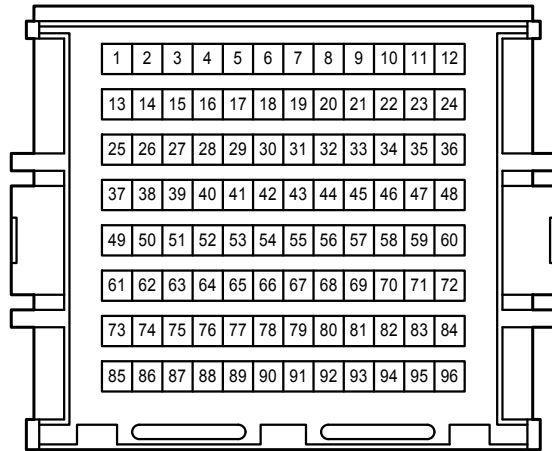

AL1

Blue

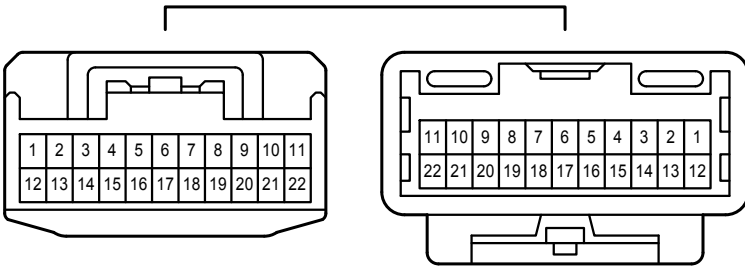

AL2  
Gray

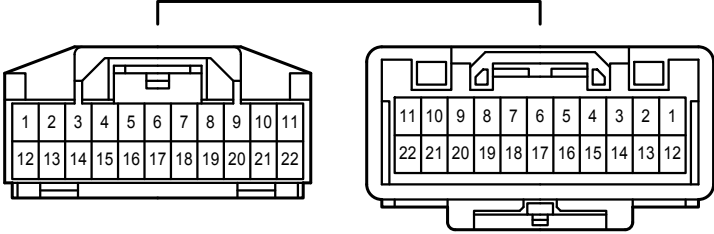

AL3  
White

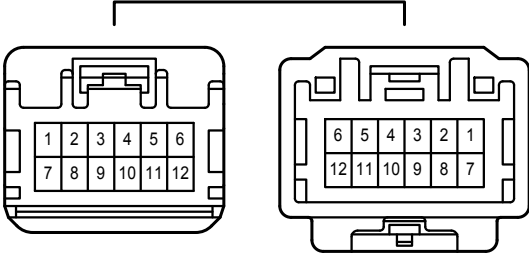

AL4  
Black

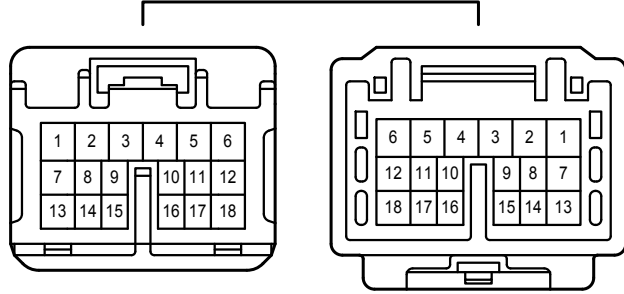

AL8  
White

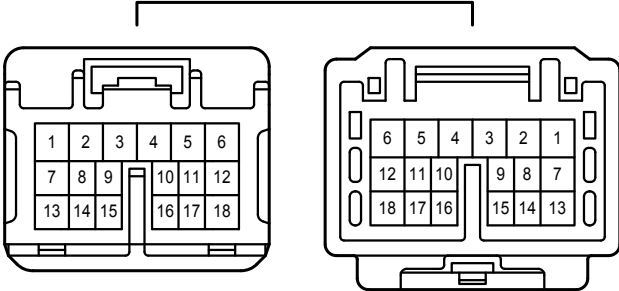

AR1  
White

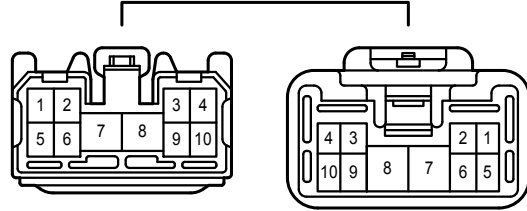

AS1  
White

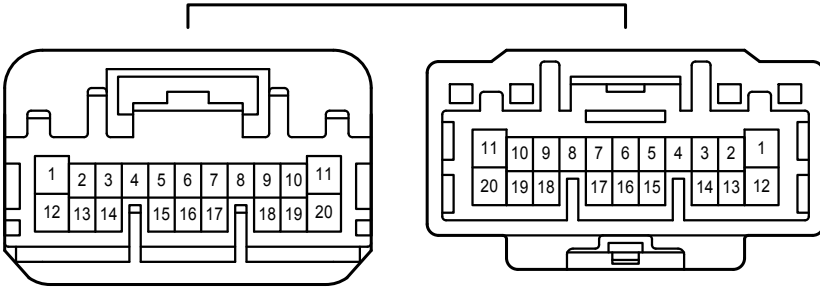

DA1  
White

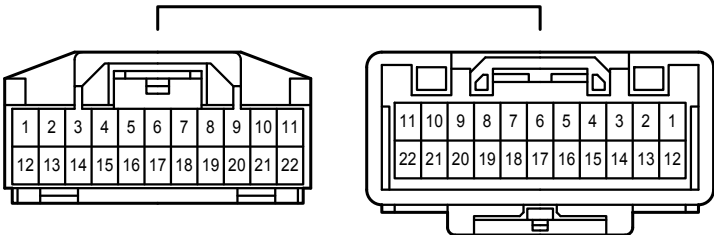

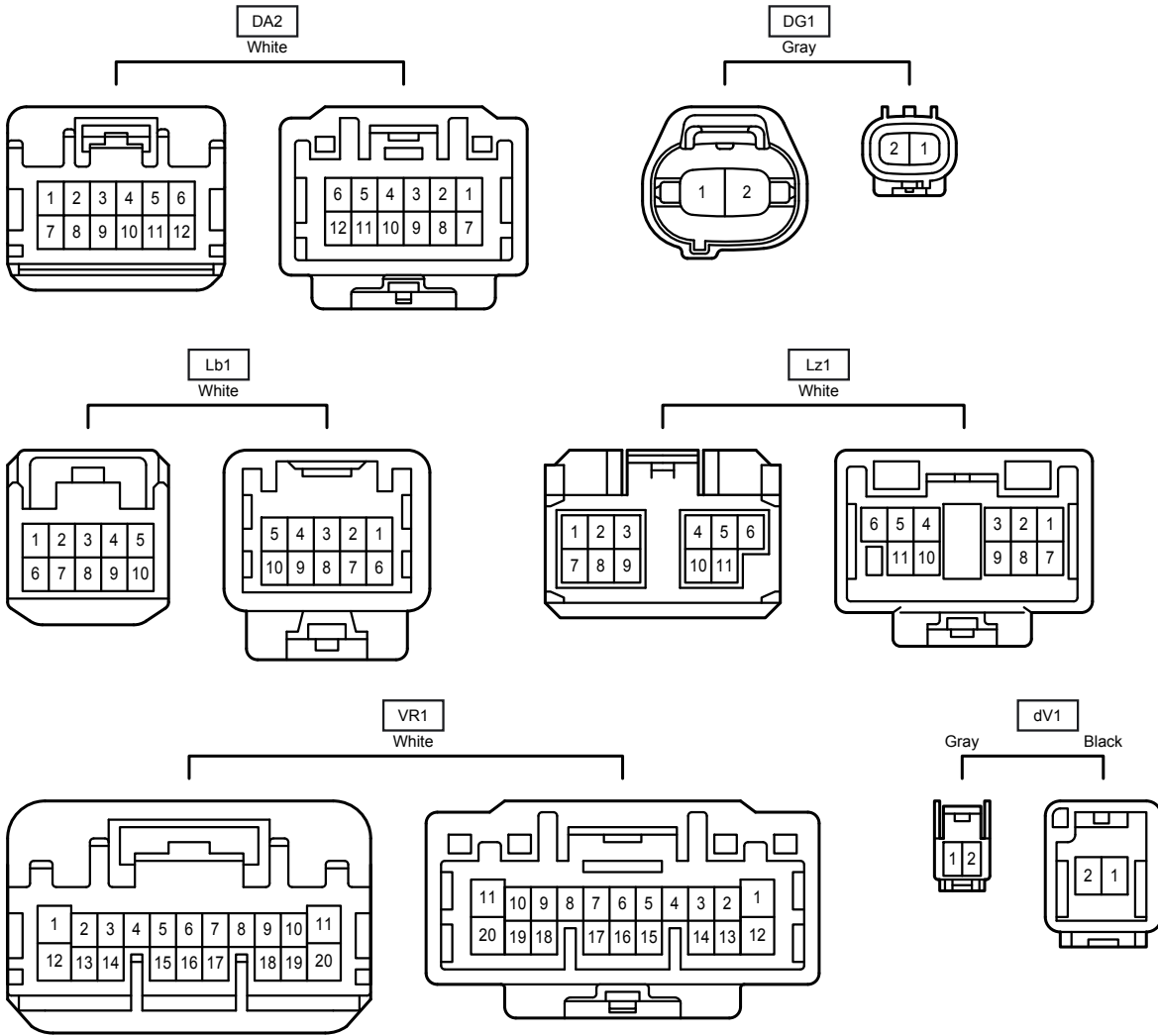

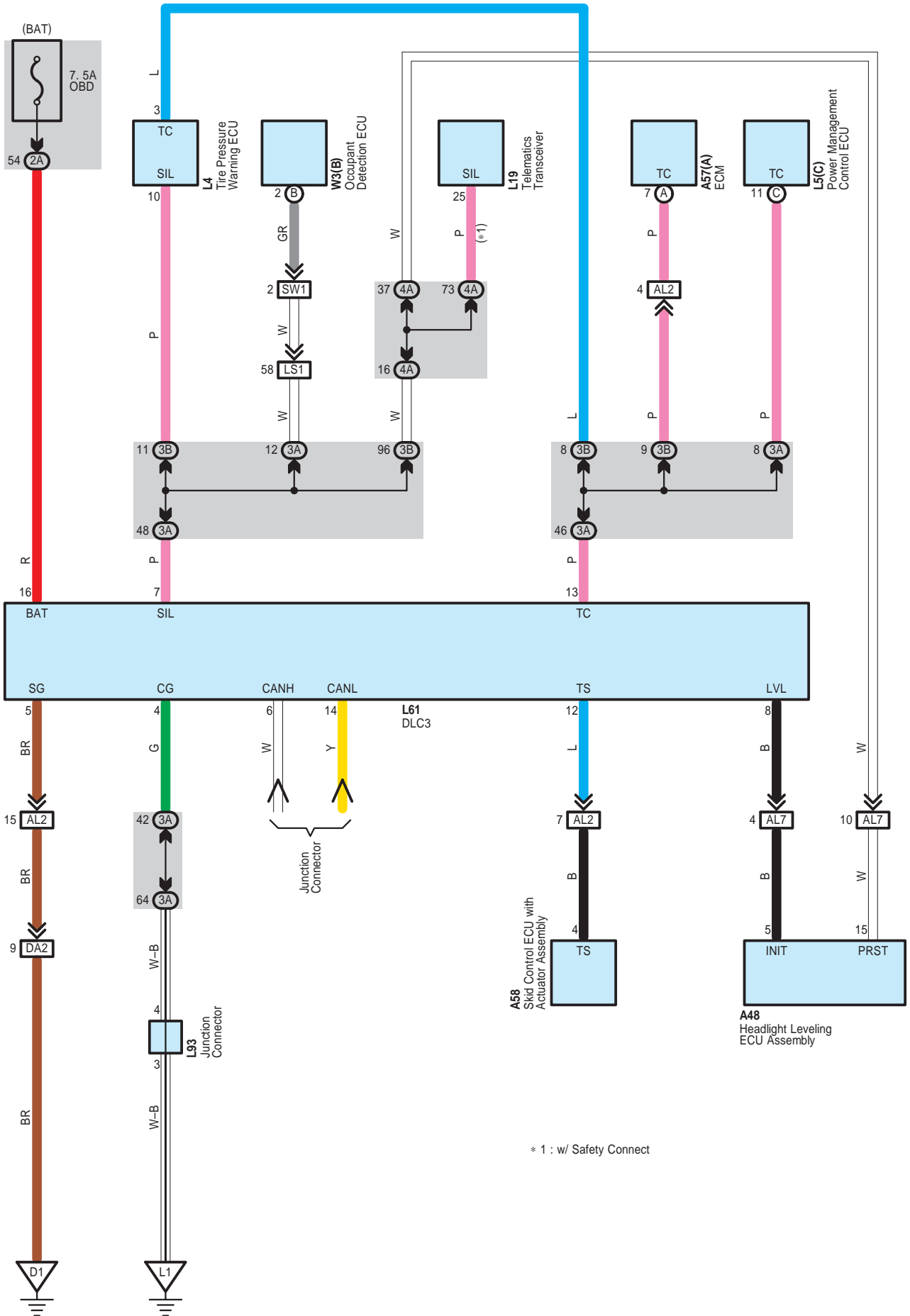

\* 1 : w/ Safety Connect



2A

White

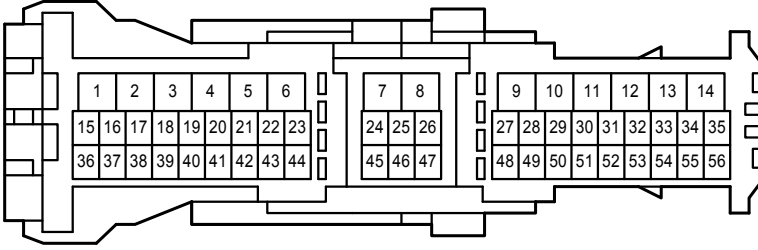

3A

White

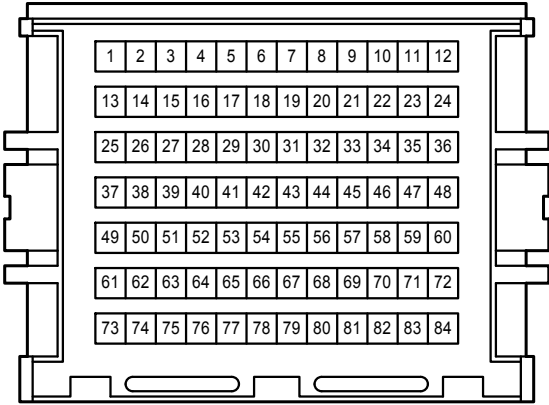

3B

White

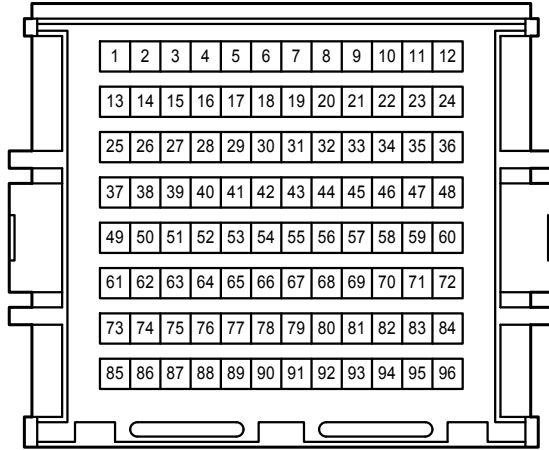

4A

White

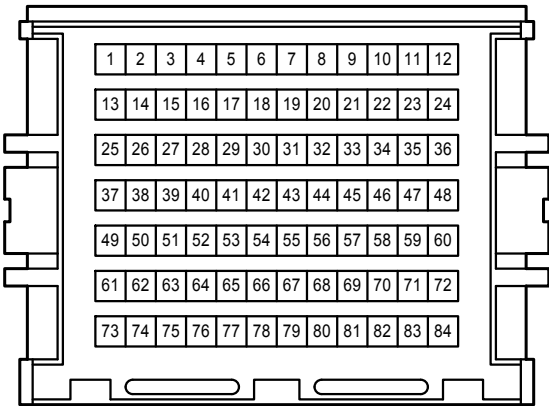

AL2

Gray

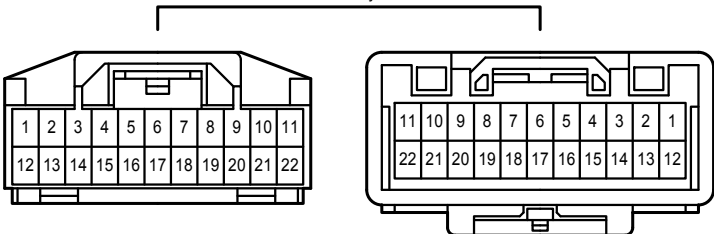

DLC3

AL7  
Black

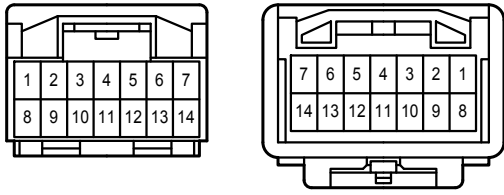

DA2  
White

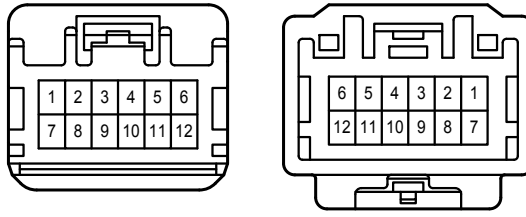

LS1  
White

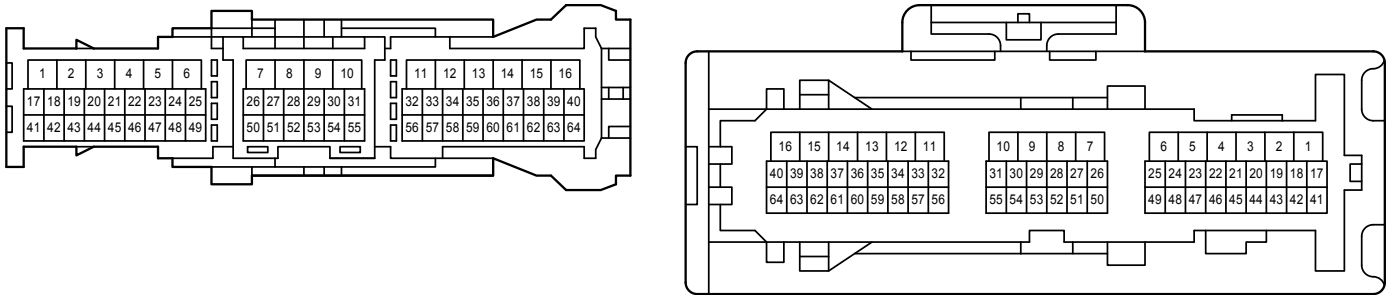

SW1  
Gray

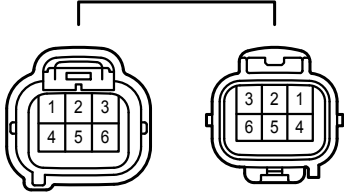

# Door Lock Control

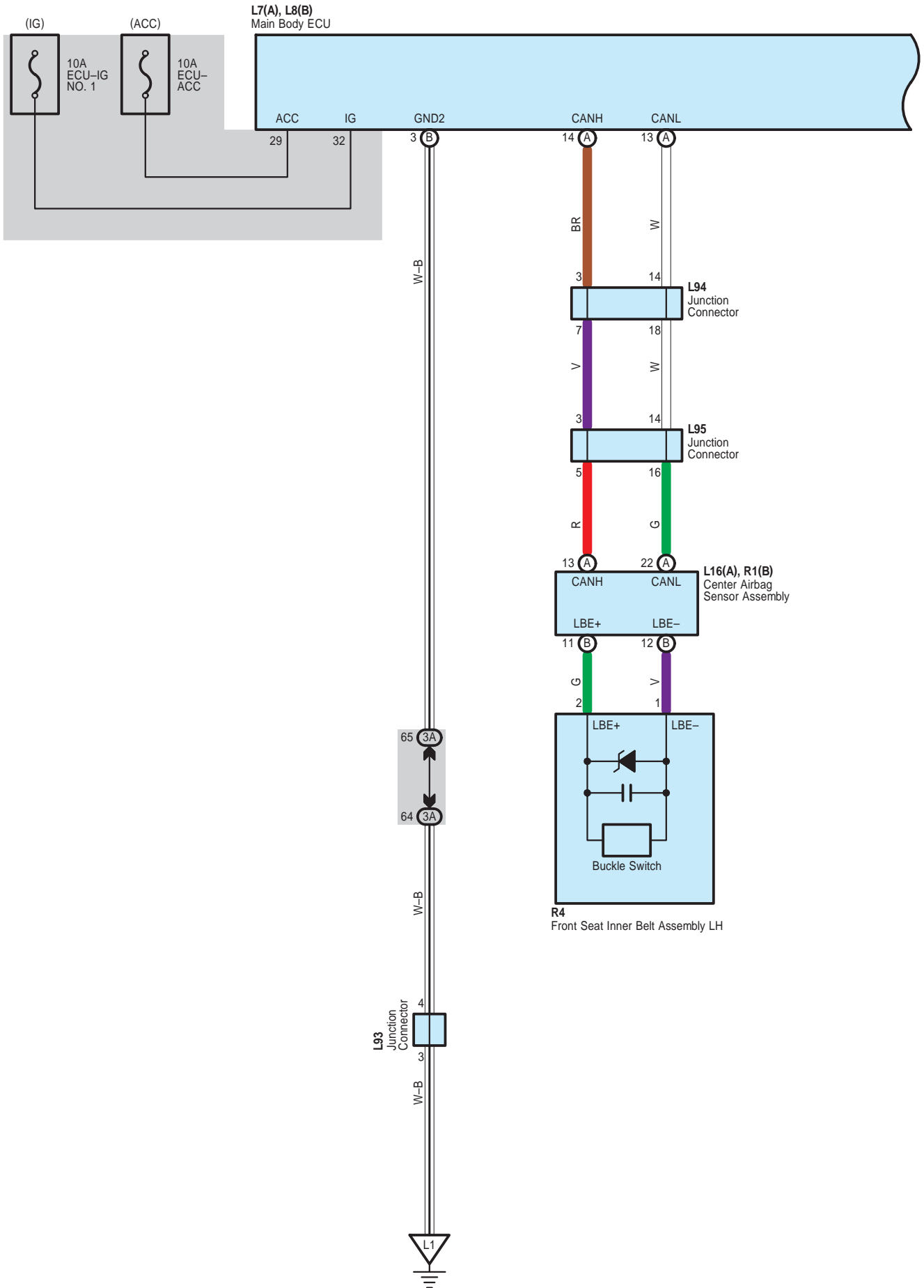



# Door Lock Control

L7(A), L8(B)  
Main Body ECU

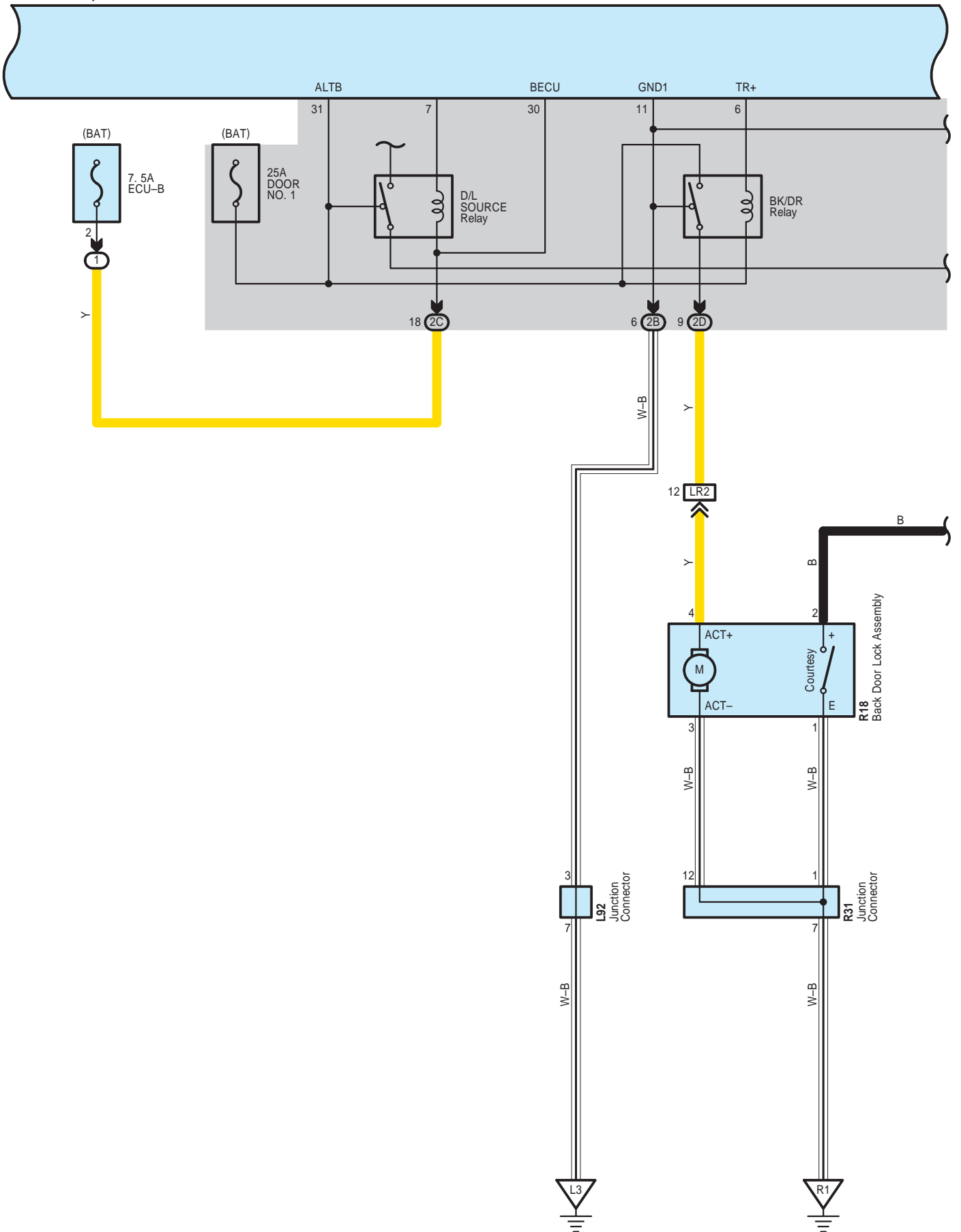

# Door Lock Control

L7(A), L8(B)  
Main Body ECU

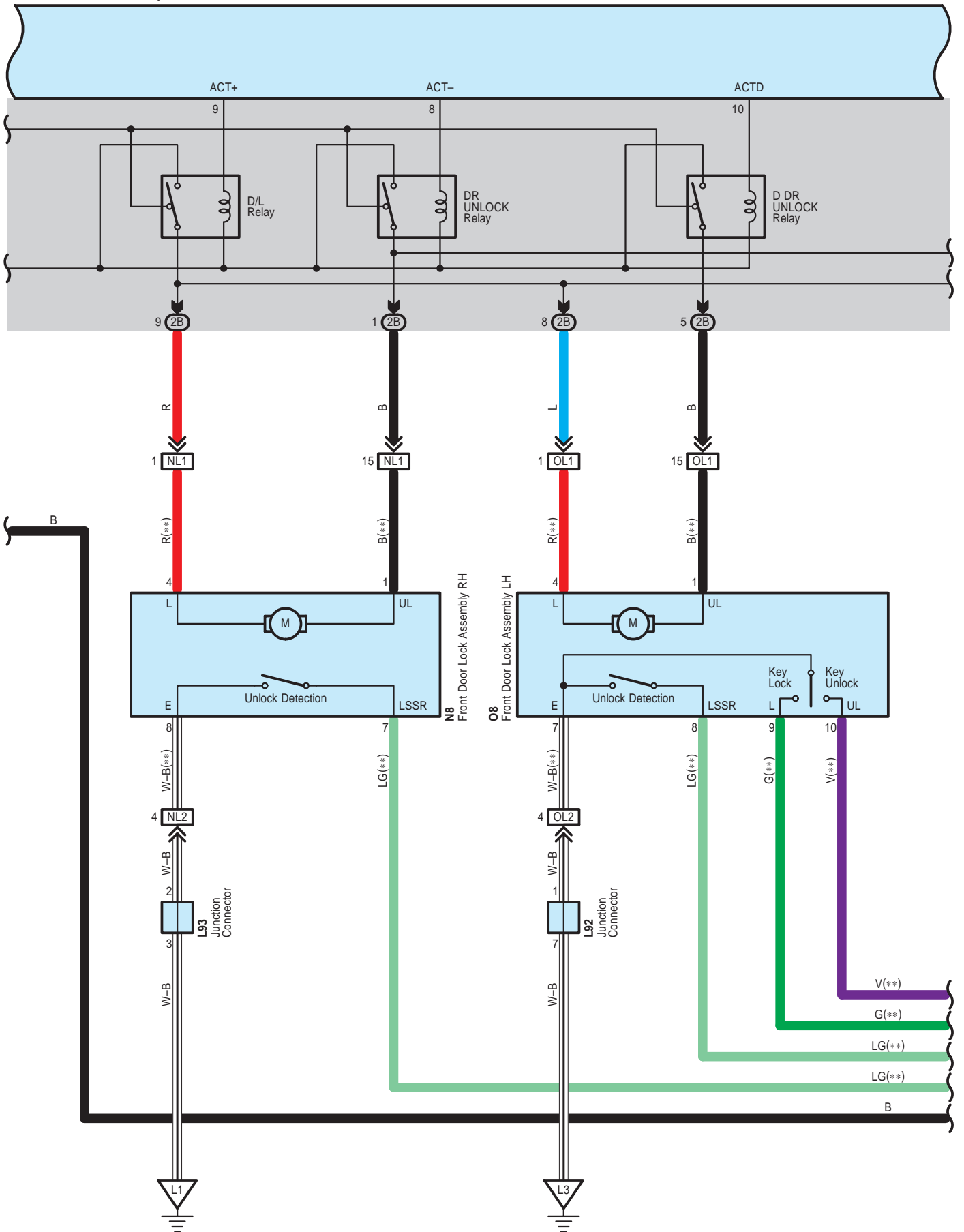

# Door Lock Control

L7(A), L8(B)  
Main Body ECU

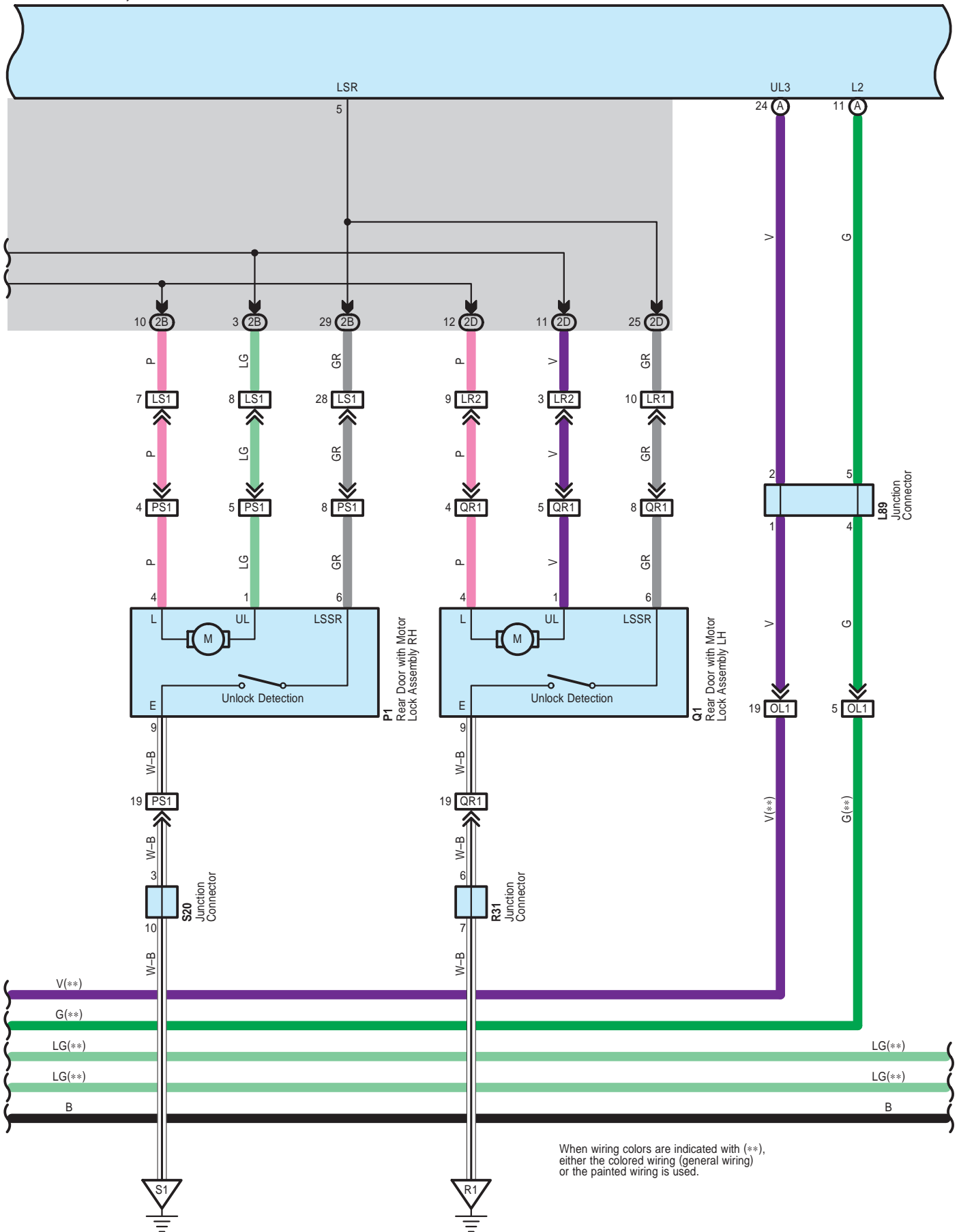

When wiring colors are indicated with (\*\*), either the colored wiring (general wiring) or the painted wiring is used.

# Door Lock Control

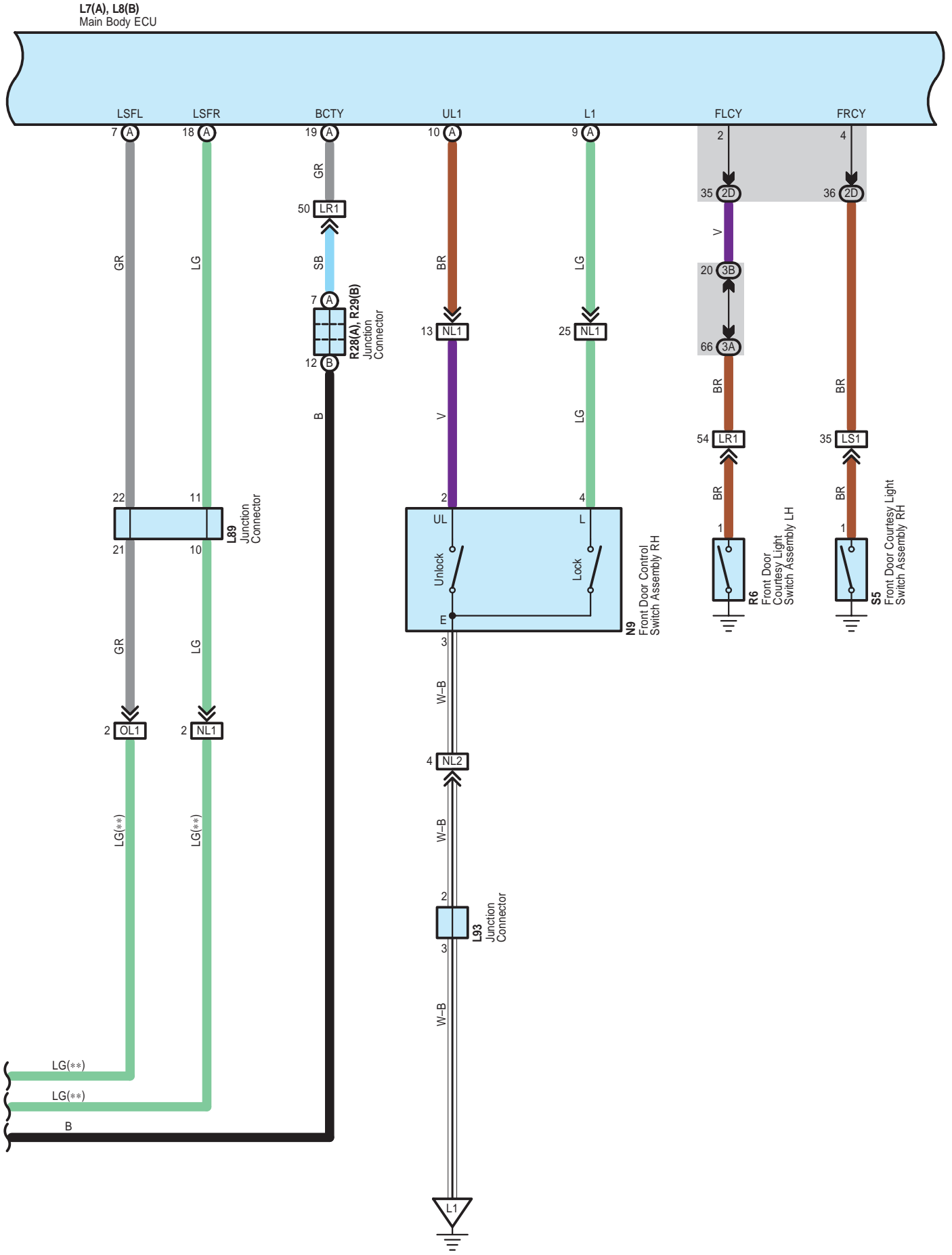

# Door Lock Control

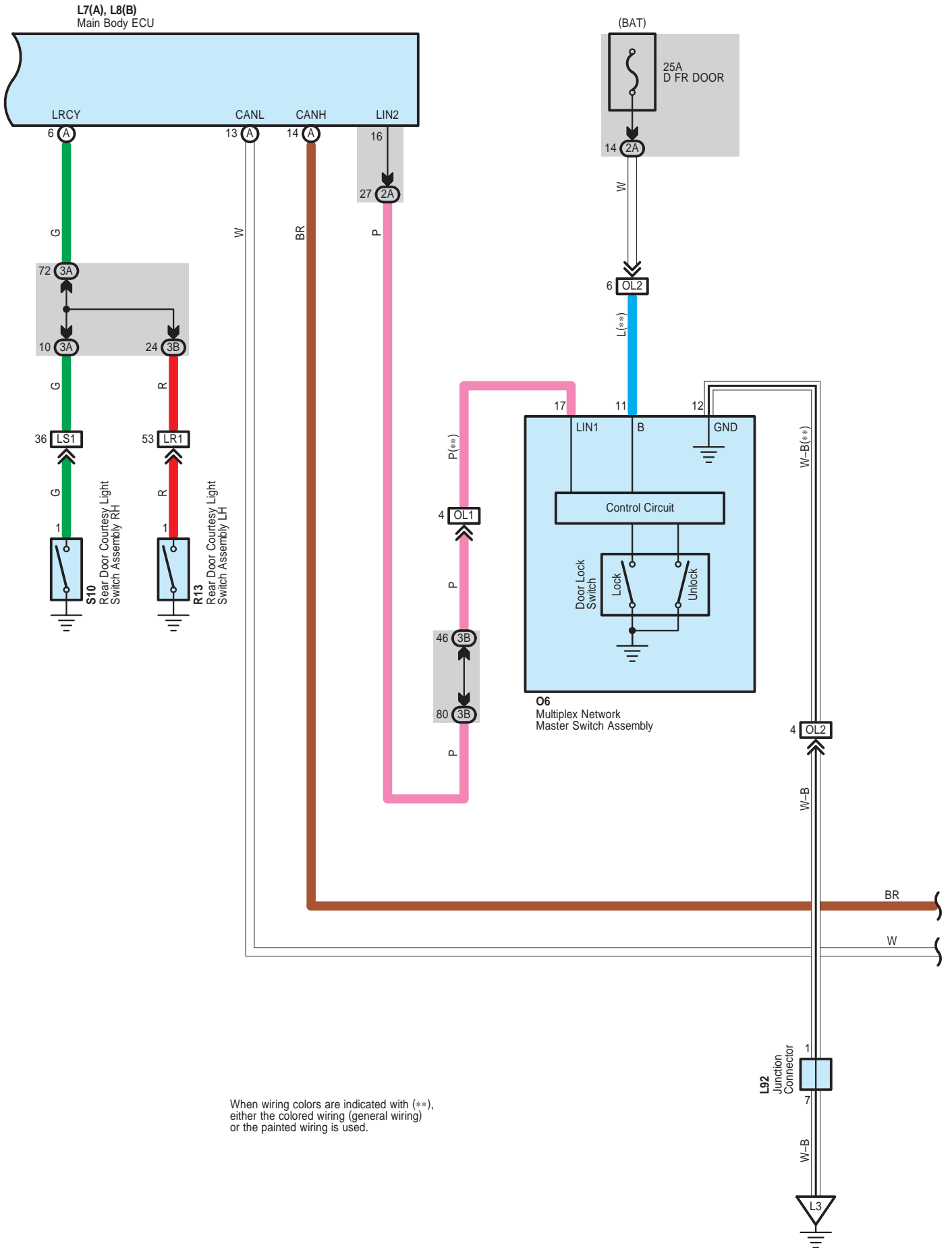

When wiring colors are indicated with (\*\*), either the colored wiring (general wiring) or the painted wiring is used.

# Door Lock Control

L5(C), L6(D)  
Power Management Control ECU

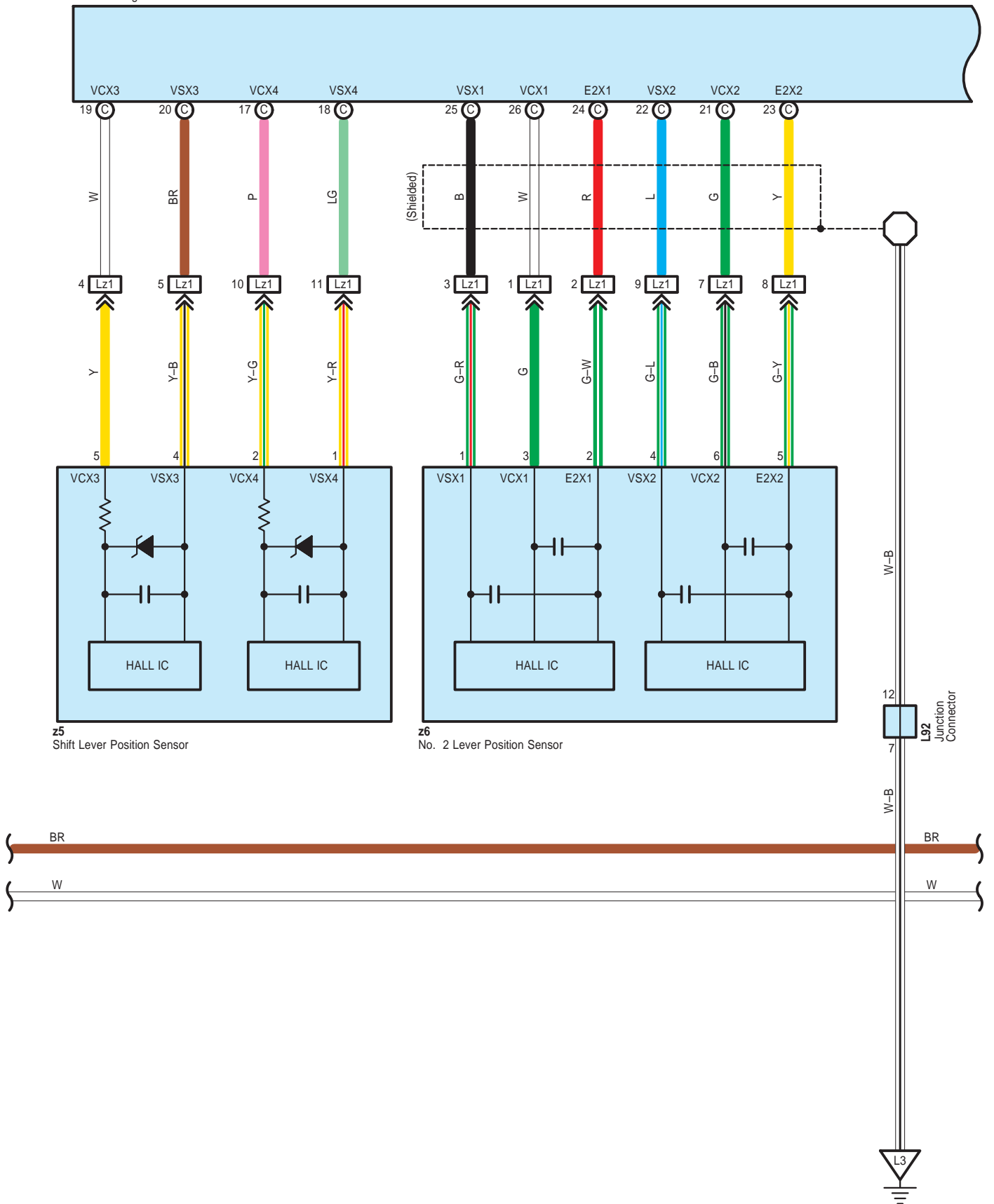

# Door Lock Control

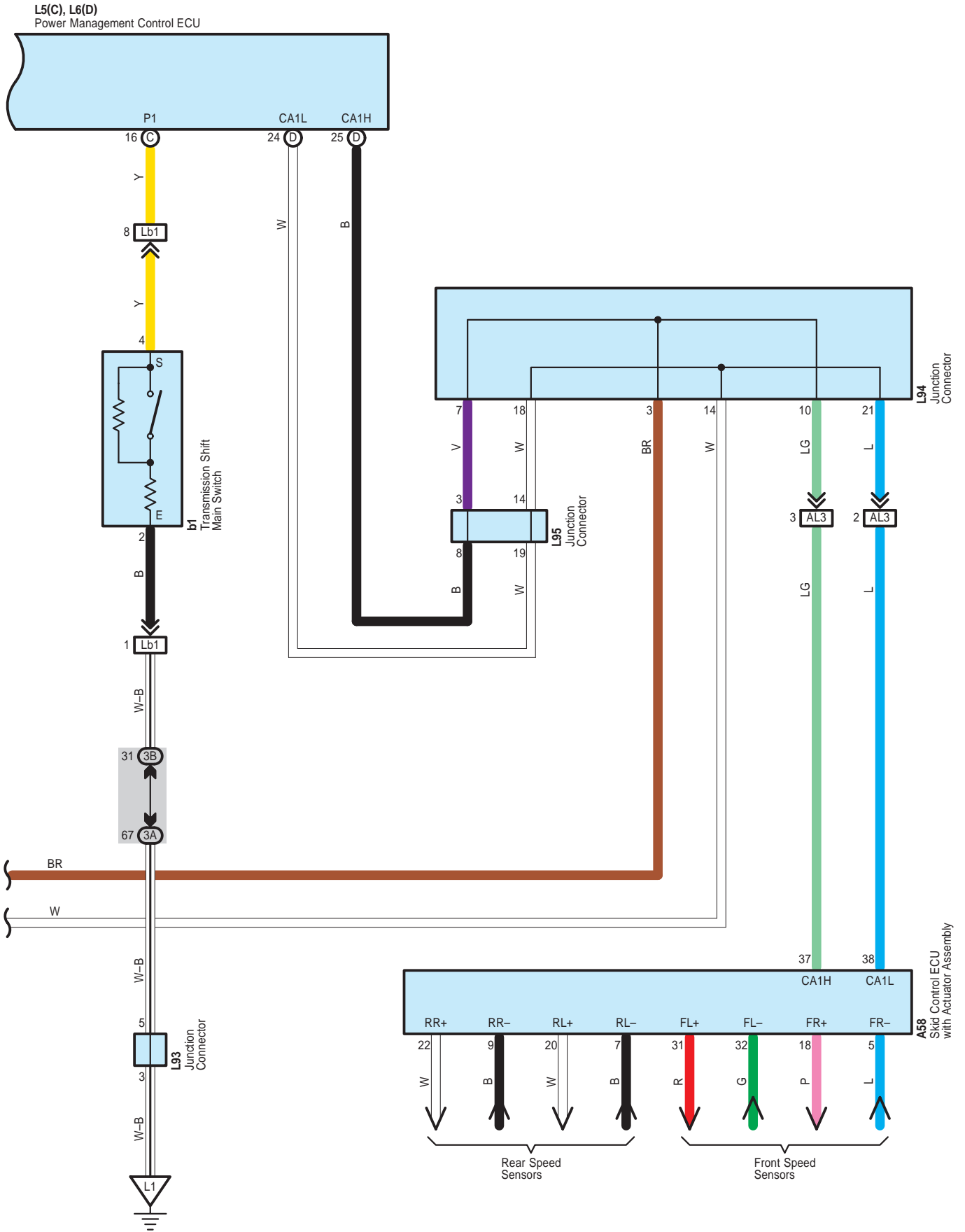

Door Lock Control

A 58  
Gray

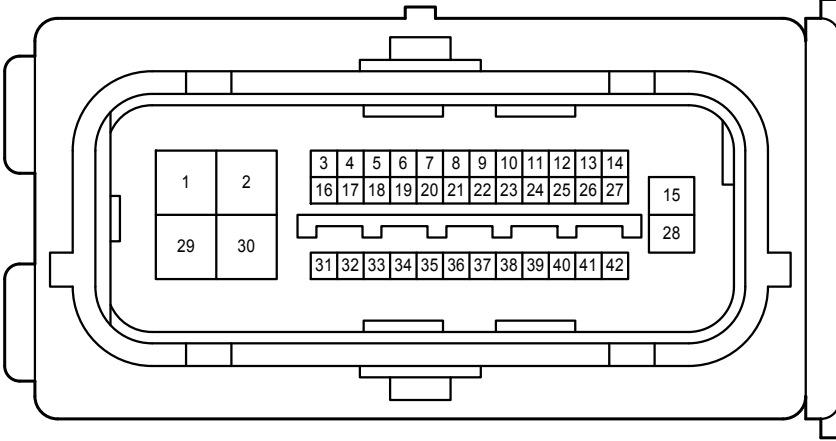

L 5  
Gray

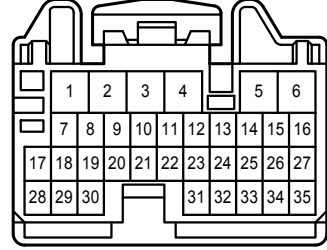

L 6  
Gray

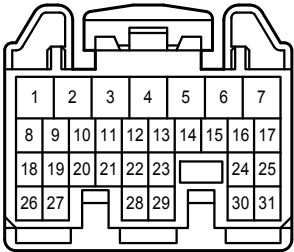

L 7  
White

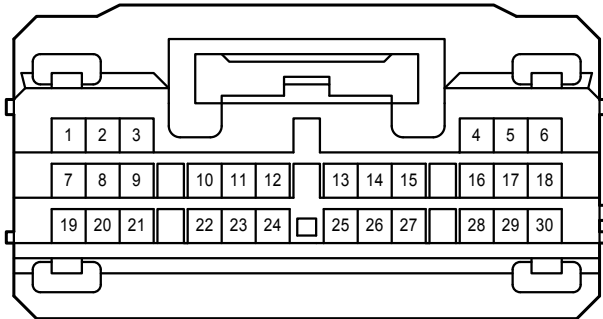

L 8  
White

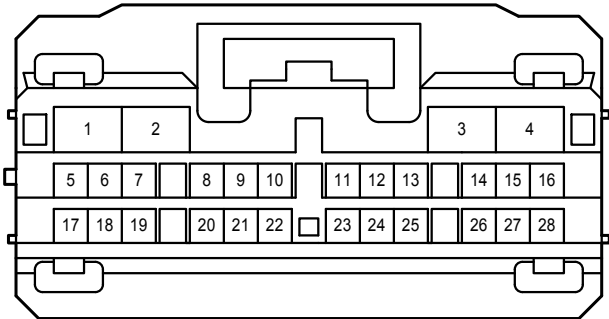

L 16  
Yellow

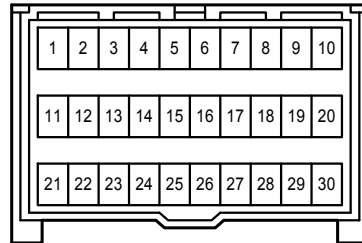

L 89  
Black

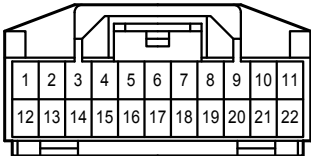

L 92  
White

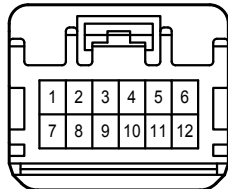

L 93  
White

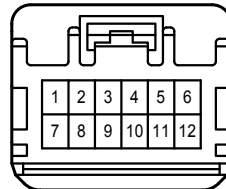



Door Lock Control

L 94  
White

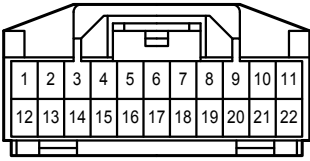

L 95  
White

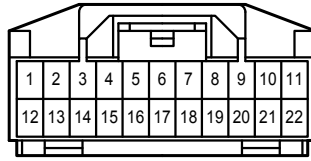

N 8  
White

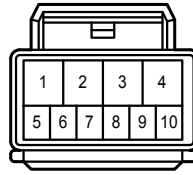

N 9  
White

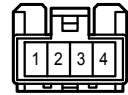

O 6  
White

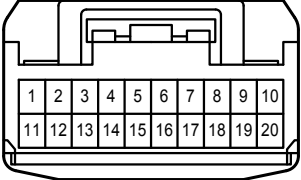

O 8  
White

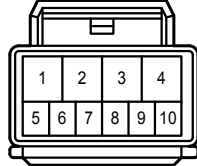

P 1  
White

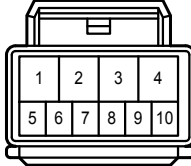

Q 1  
White

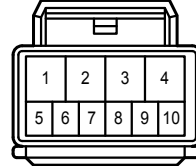

R 1  
Yellow

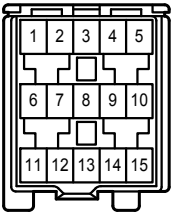

R 4  
White



R 6  
Black



R 13  
Black



R 18  
White

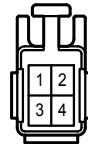

R 28  
White

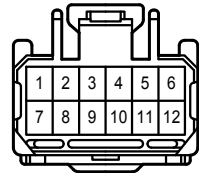

R 29  
White

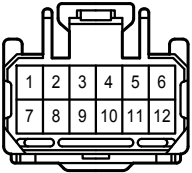

R 31  
White

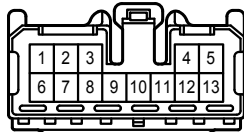

S 5  
Black



S 10  
Black



S 20  
White

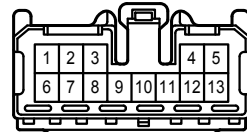

b 1  
White

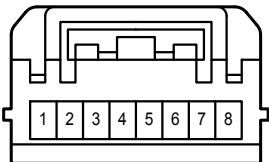

z 5  
White

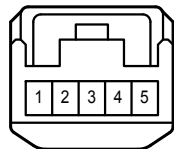

z 6  
White

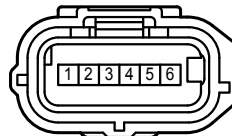

2A  
White

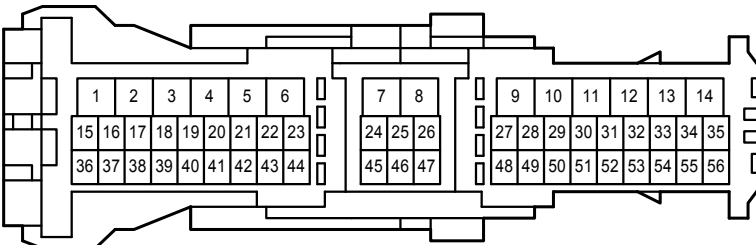

Door Lock Control

2B

White

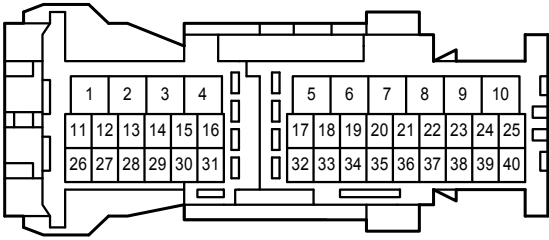

2C

White

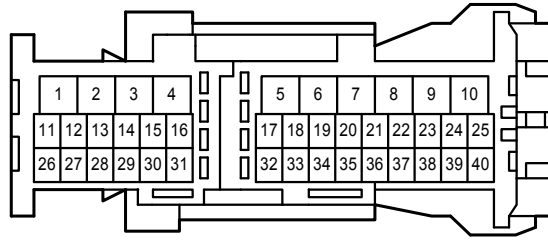

2D

White

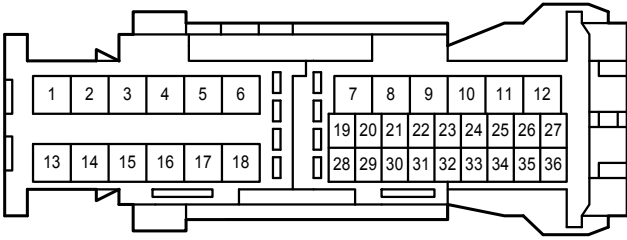

3A

White

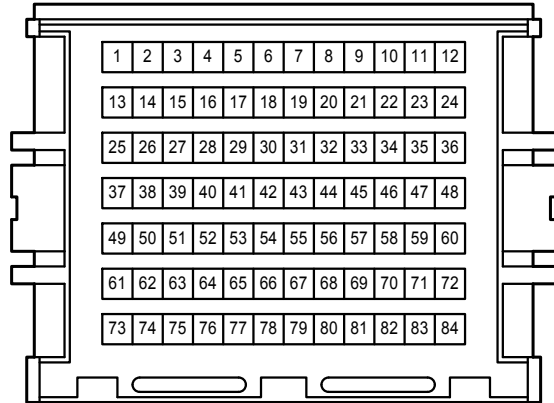

3B

White

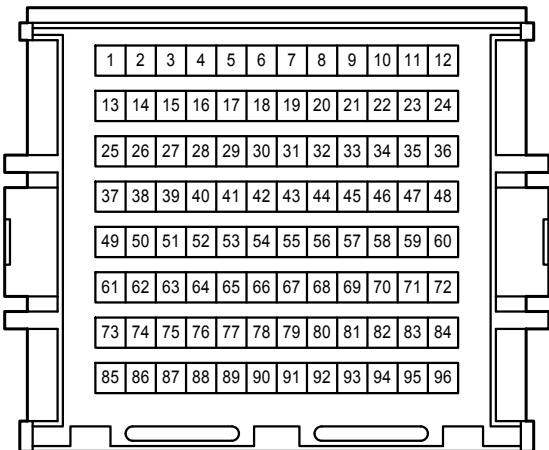

AL3

White

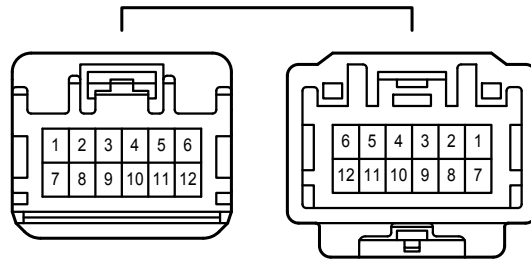

LR1

White

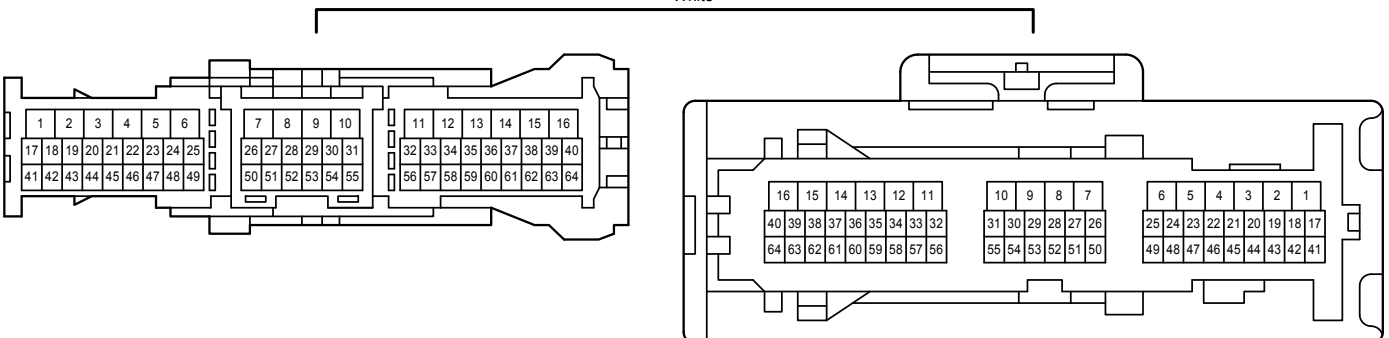

Door Lock Control

LR2  
Black

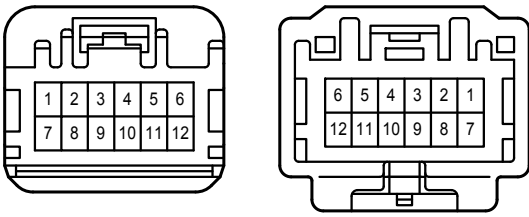

LS1  
White

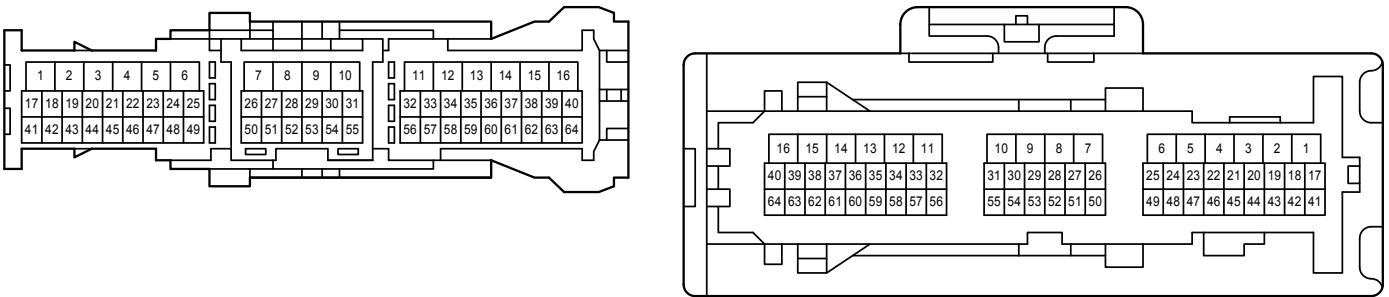

Lb1  
White

Lz1  
White

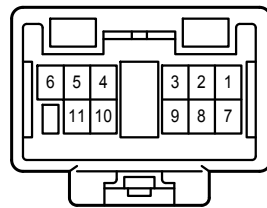
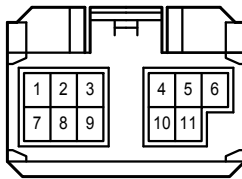
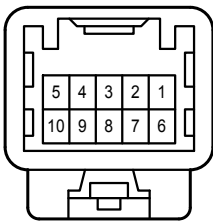
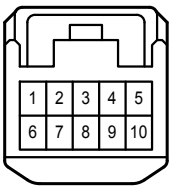

NL1  
White

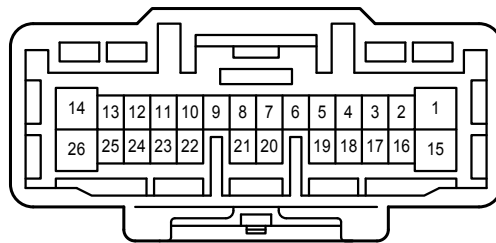
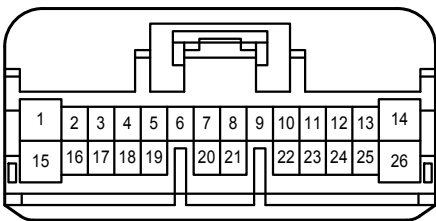

NL2  
White

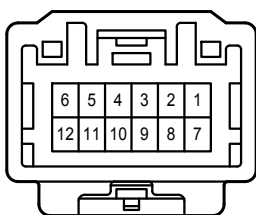
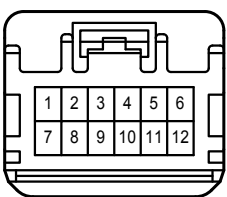

Door Lock Control

OL1  
White

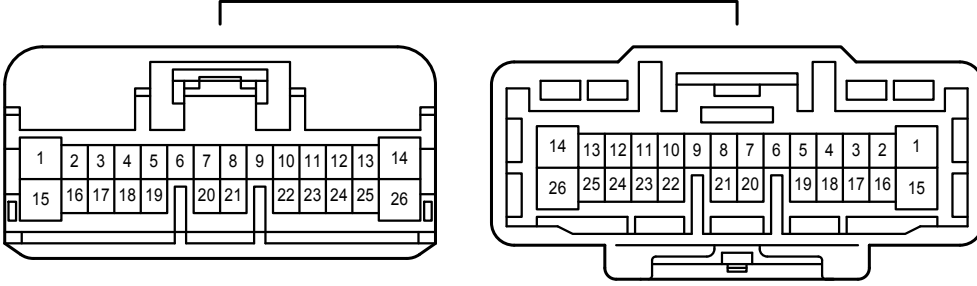

OL2  
White

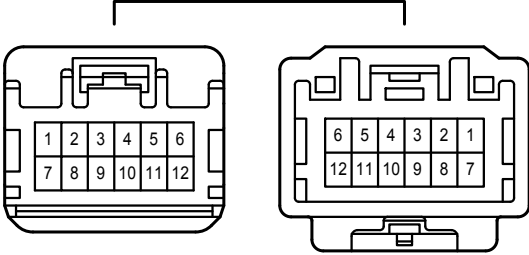

PS1  
White

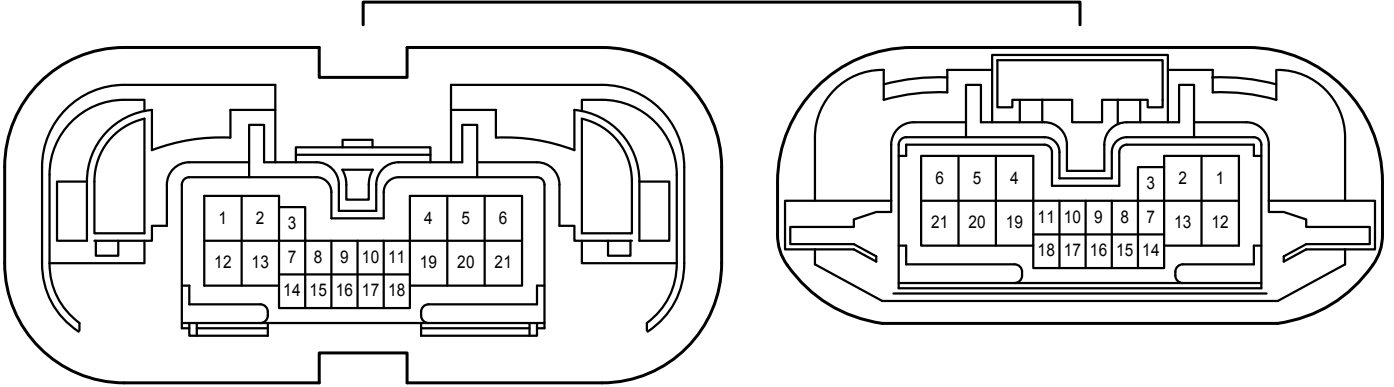

QR1  
White

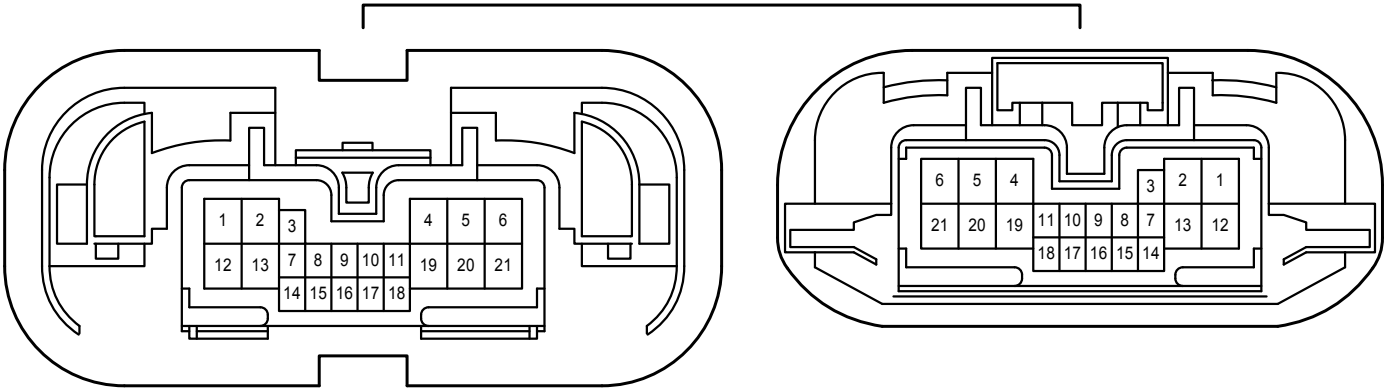

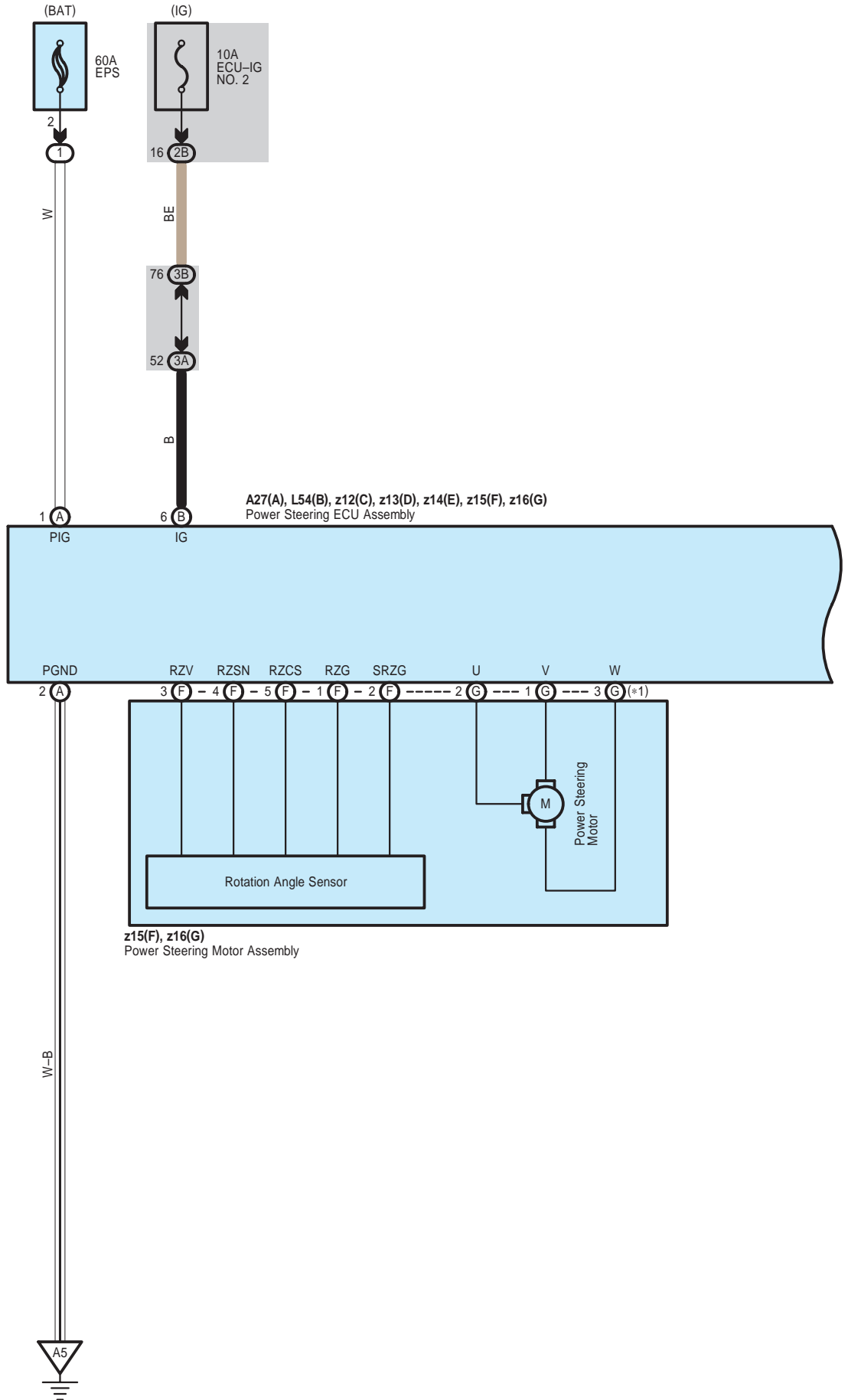

\* 1 : w/ Rotation Angle Sensor  
 \* 2 : w/o Rotation Angle Sensor

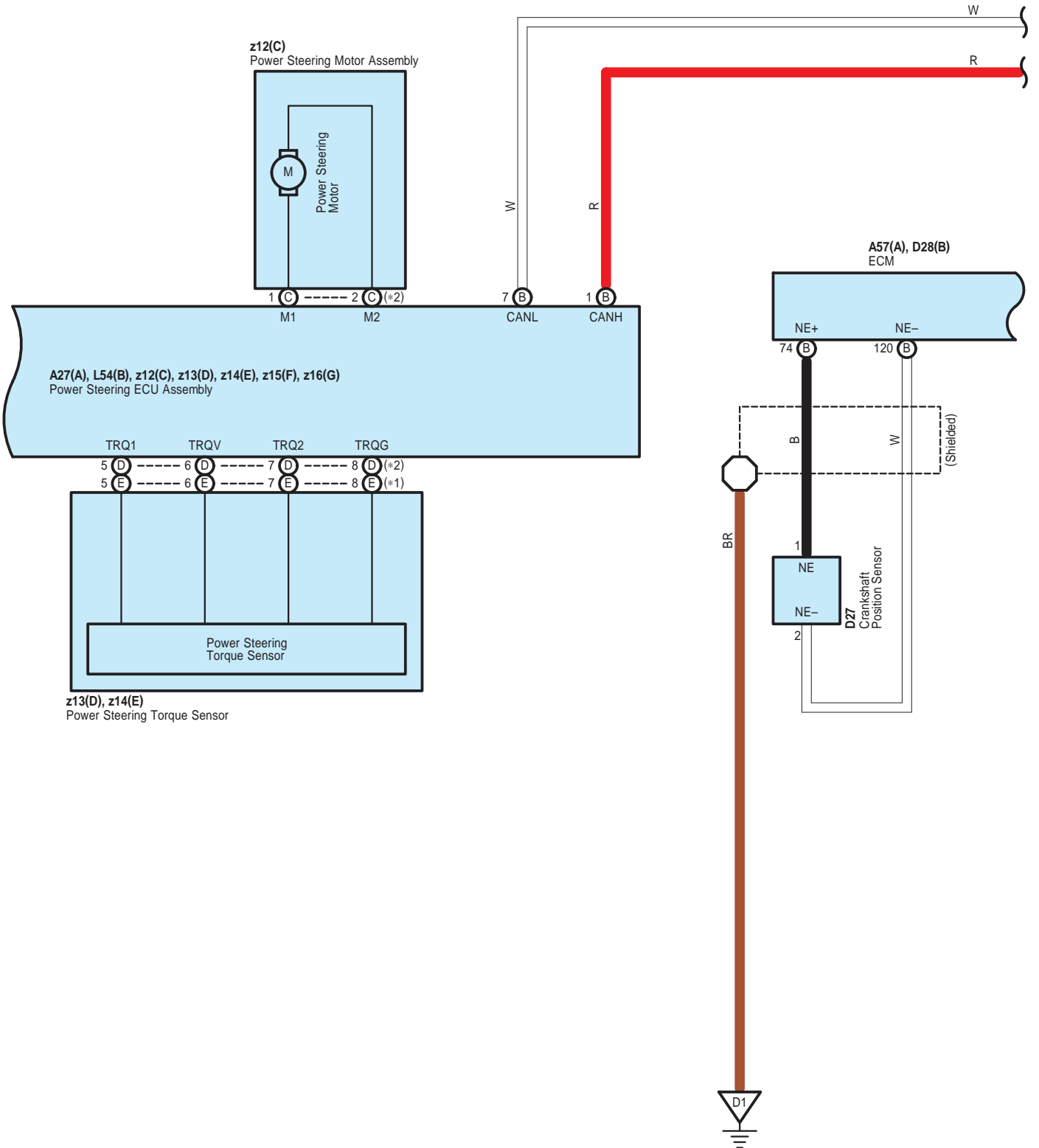

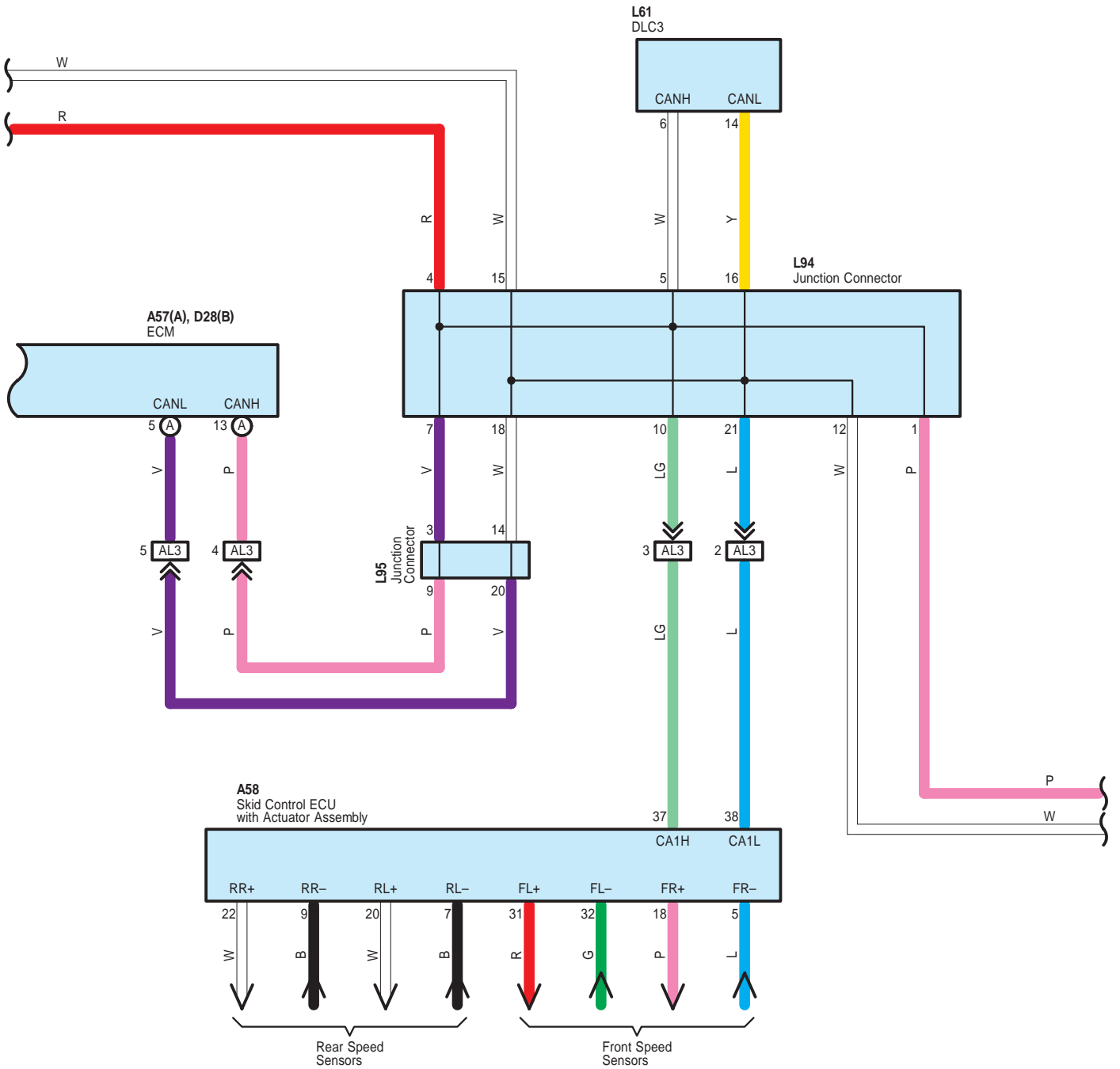

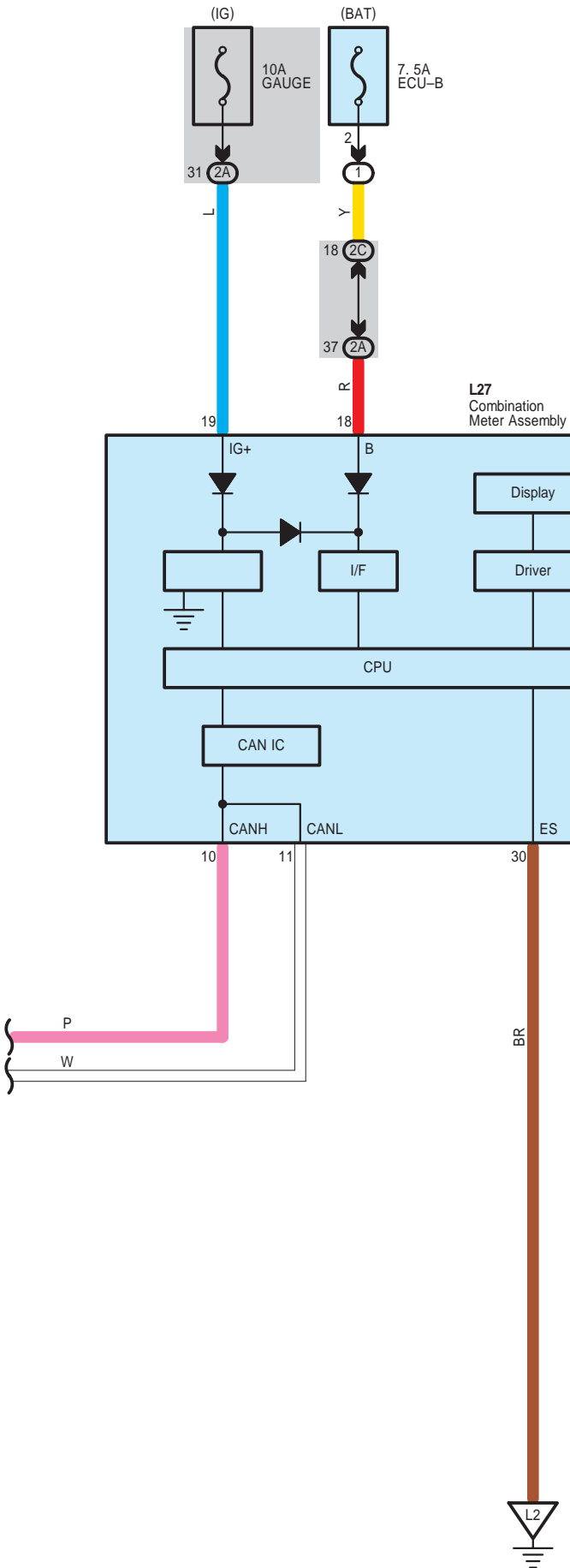



A 27  
Gray

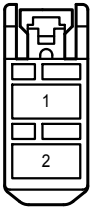

A 57  
Black

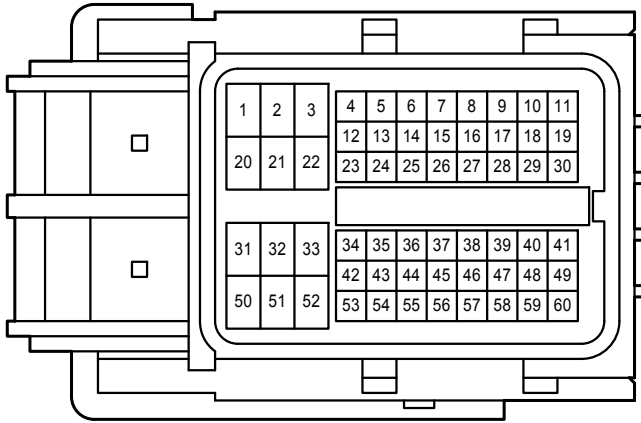

A 58  
Gray

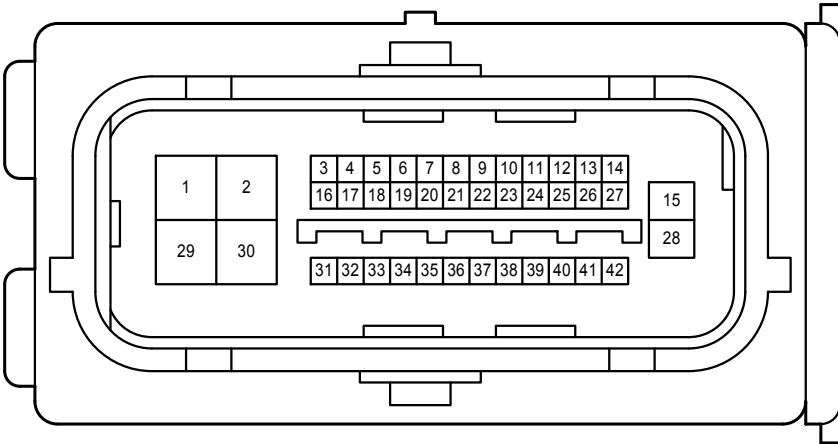

D 27  
Black

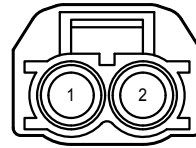

D 28  
Black

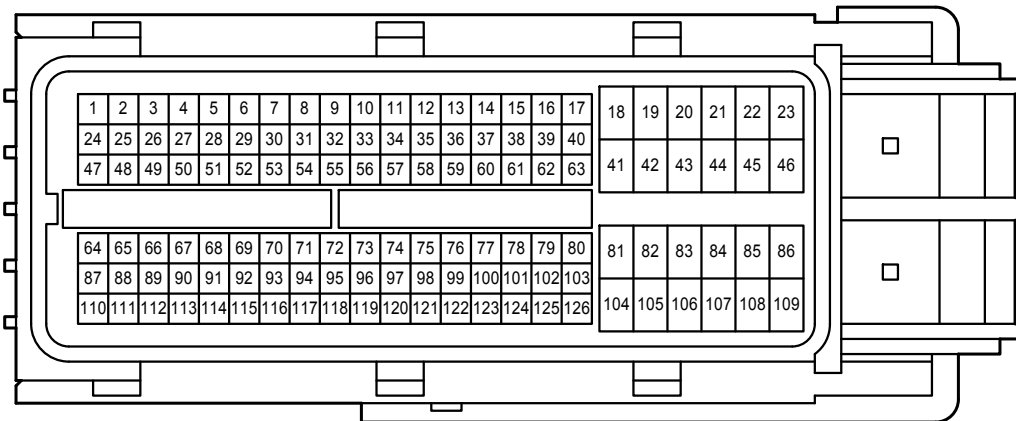

L 27  
White

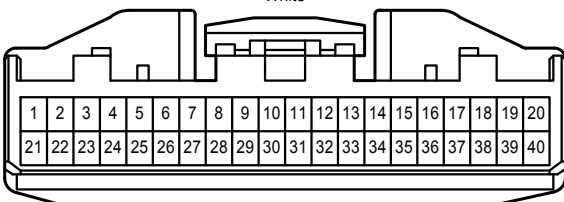

L 54  
White

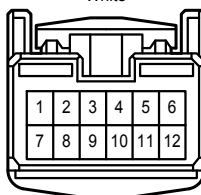

L 61  
White

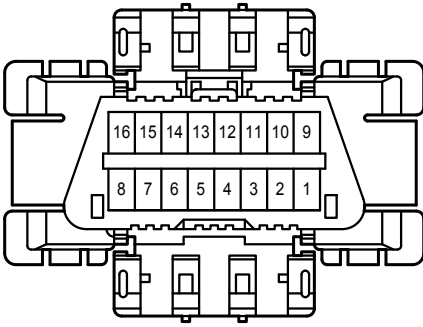

L 94  
White

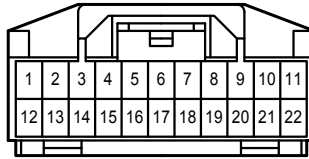

L 95  
White

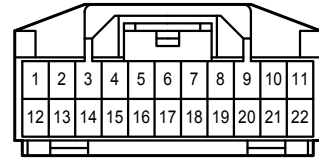

z 12  
White

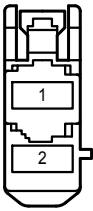

z 13  
Black

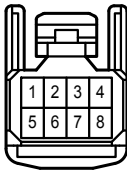

z 14  
White

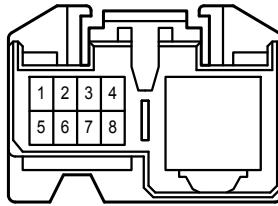

z 15  
White

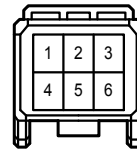

z 16  
White

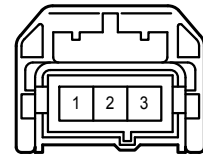

2A  
White

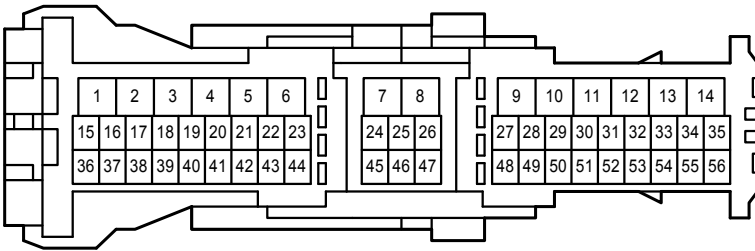

2B  
White

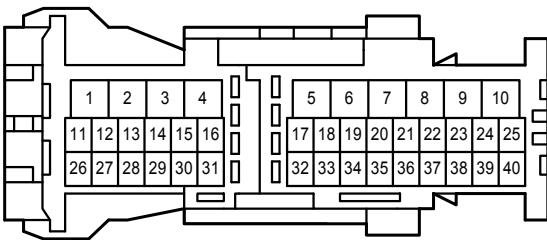

2C  
White

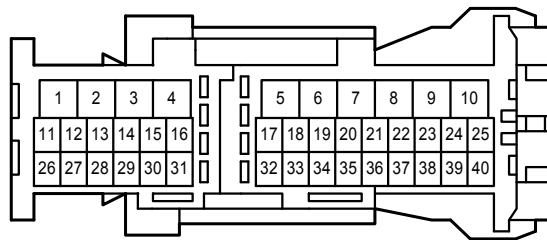

3A  
White

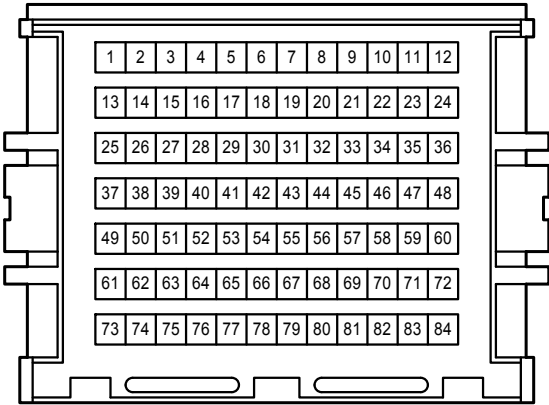

3B  
White

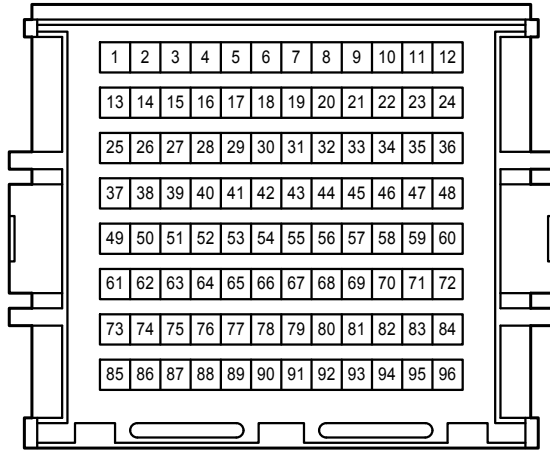

AL3  
White

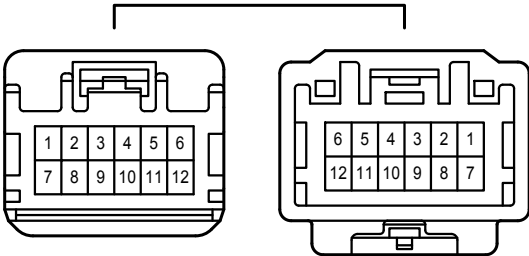

# Fog Light

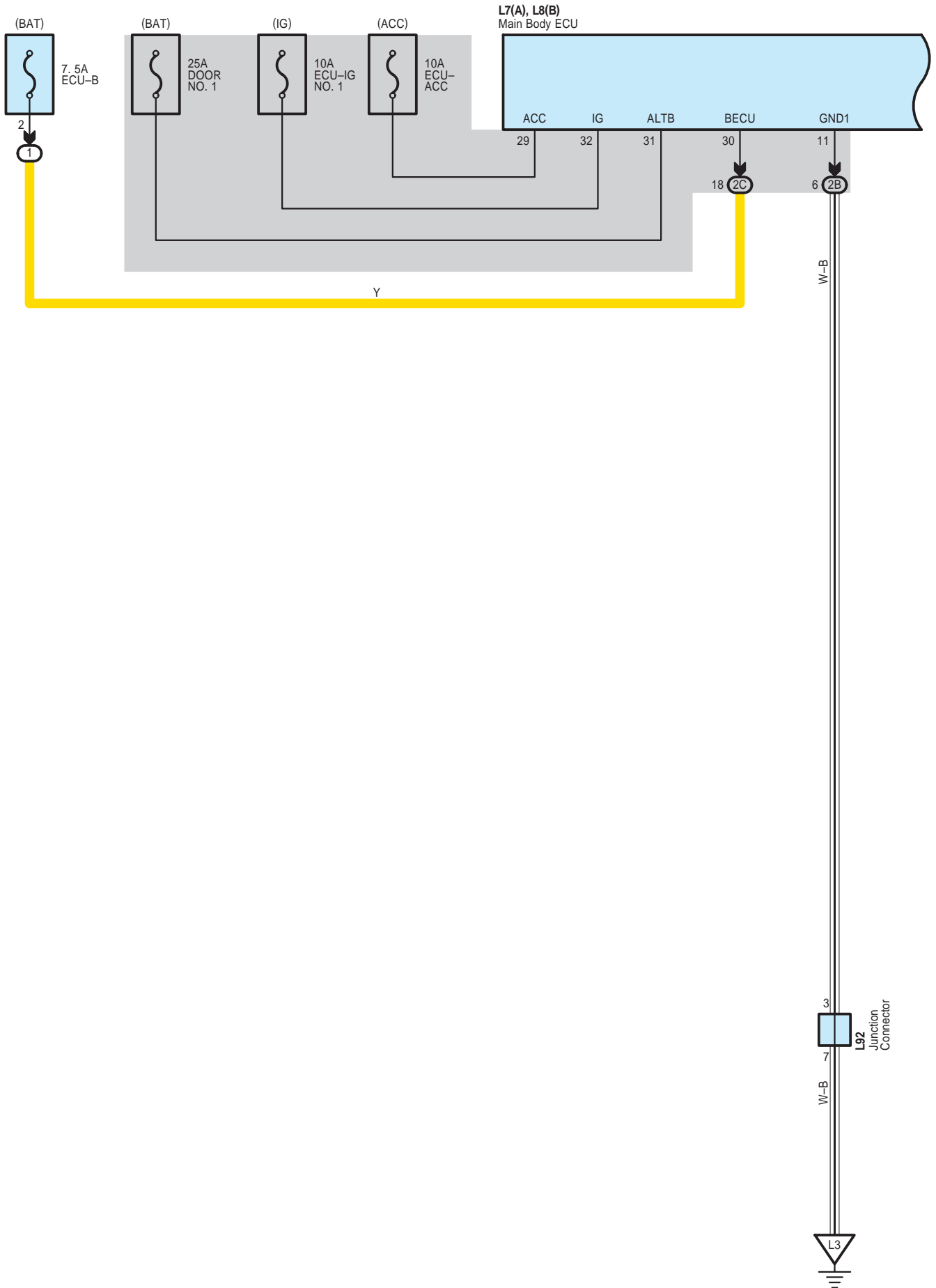

# Fog Light

L7(A), L8(B)  
Main Body ECU

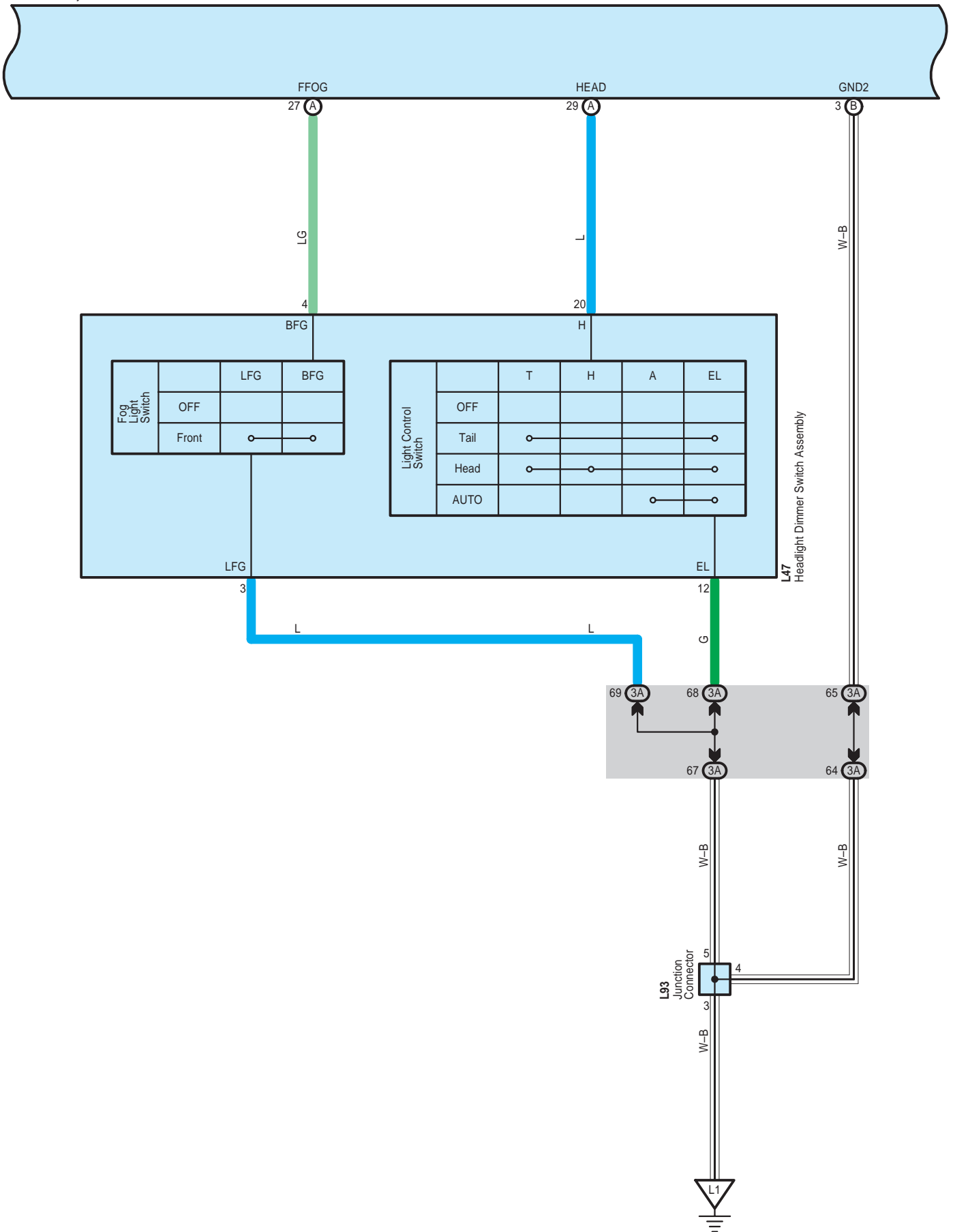

# Fog Light

L7(A), L8(B)  
Main Body ECU

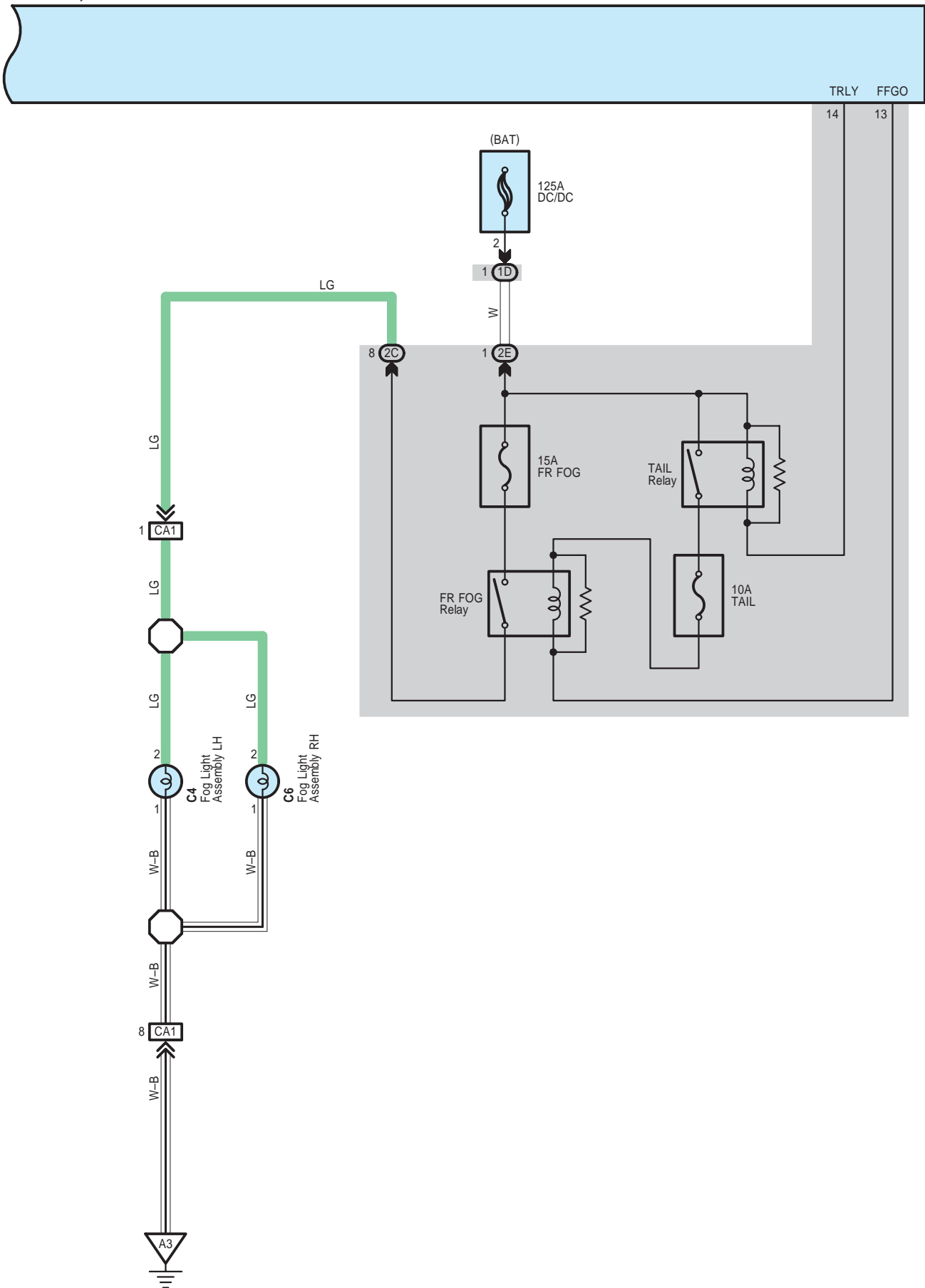

Fog Light

C 4  
Black

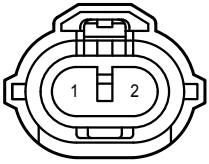

C 6  
Black

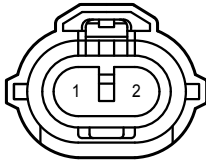

L 7  
White

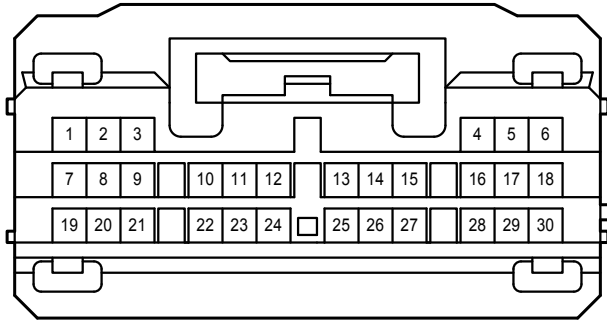

L 8  
White

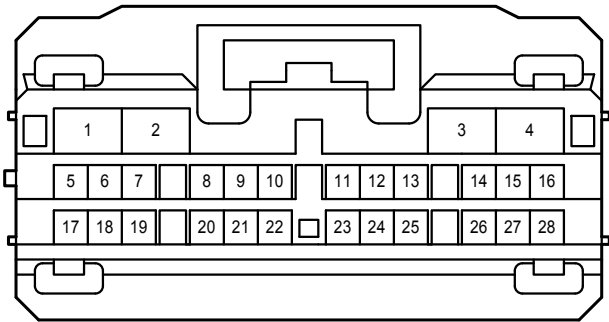

L 47  
White

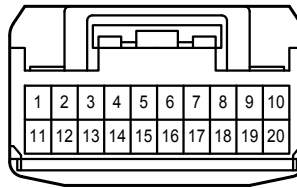

L 92  
White

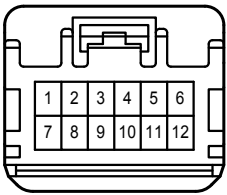

L 93  
White

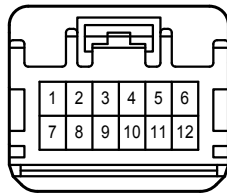

1D  
Black

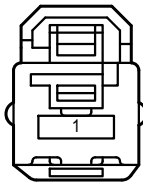

2B  
White

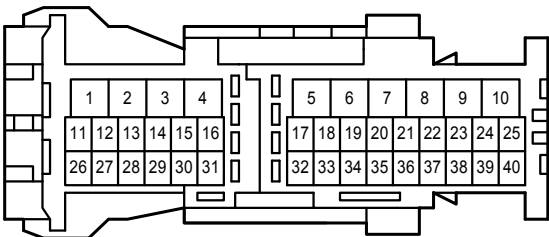

2C  
White

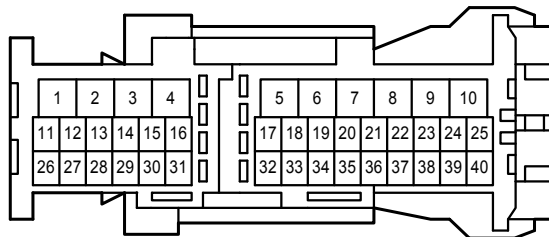

Fog Light

2E

White

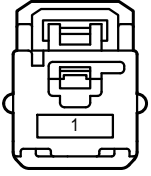

3A

White

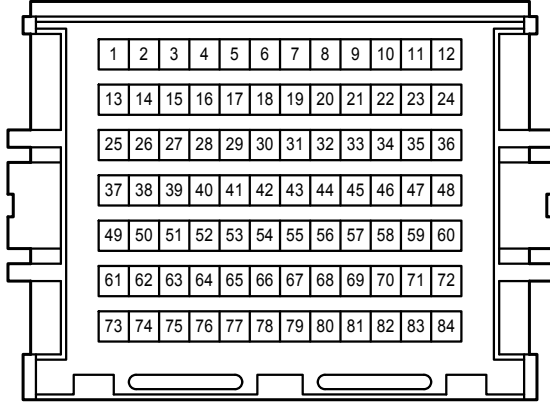

CA1

Black

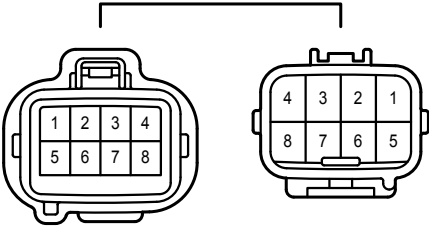



# Front Wiper and Washer

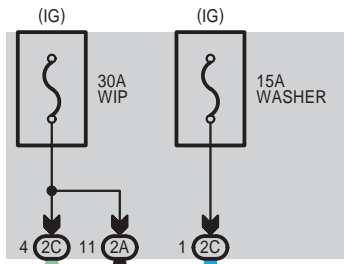

L48(A), L49(B)  
Windshield Wiper Switch Assembly

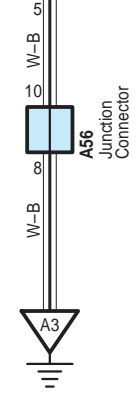
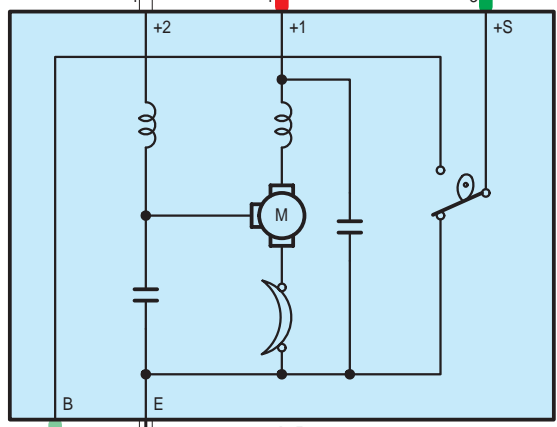
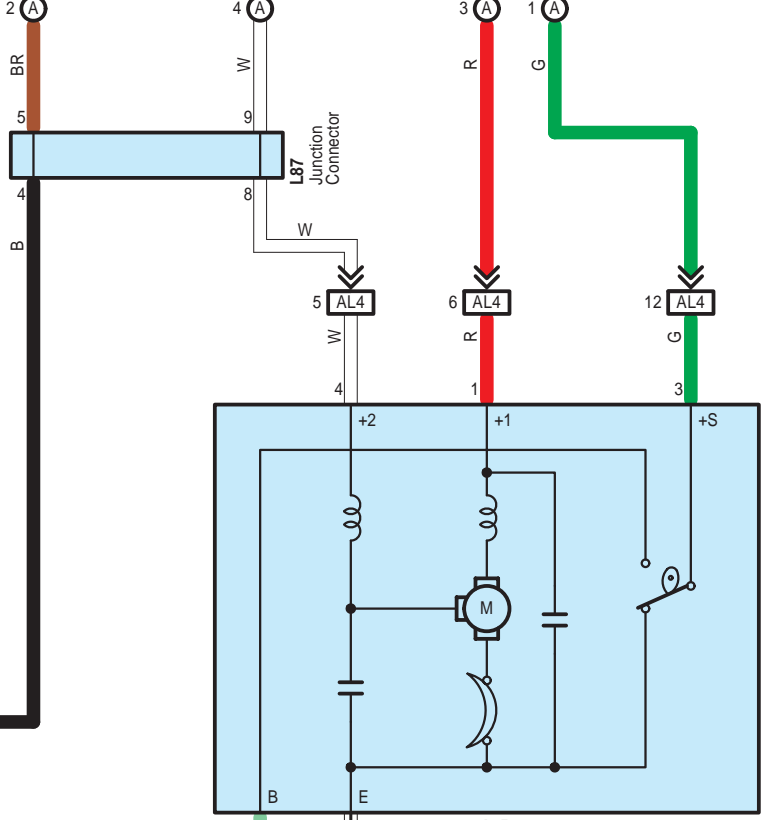
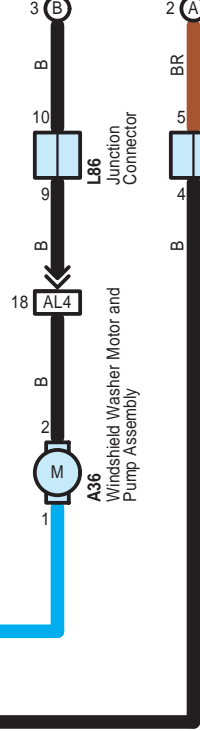
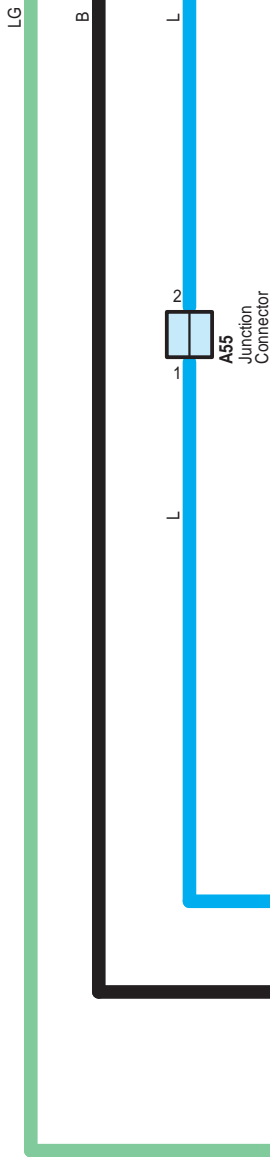
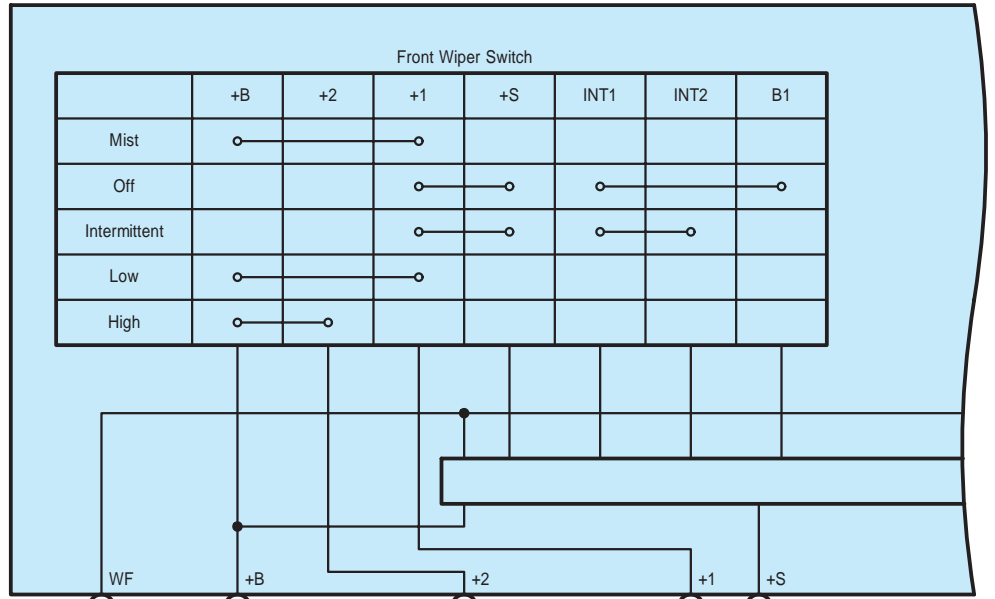

# Front Wiper and Washer

L48(A), L49(B)  
Windshield Wiper Switch Assembly

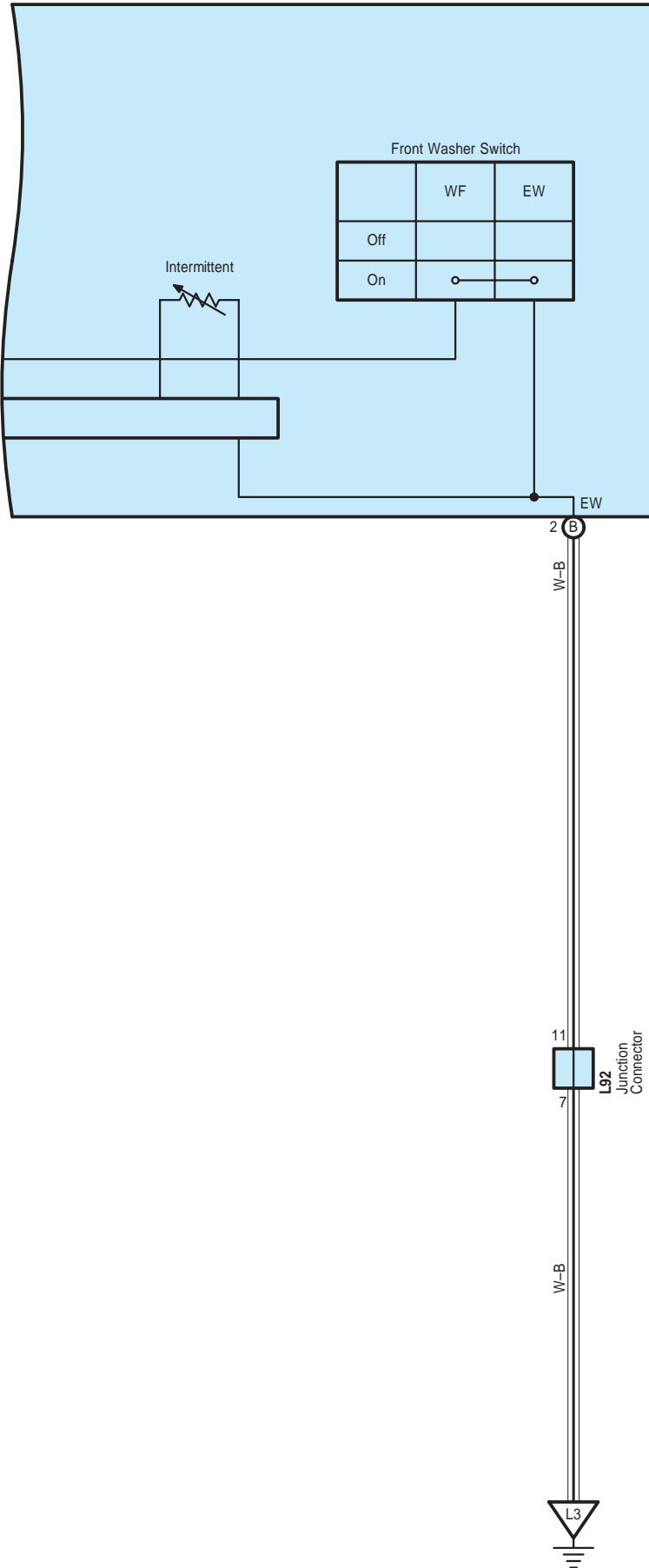

Front Wiper and Washer

A 35

Black

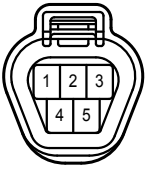

A 36

Black

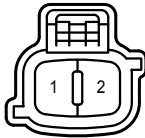

A 55

Black

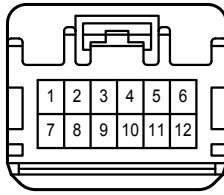

A 56

White

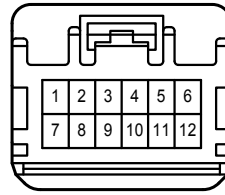

L 48

White



L 49

White

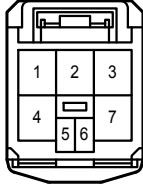

L 86

Black

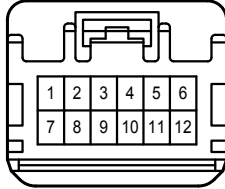

L 87

Black

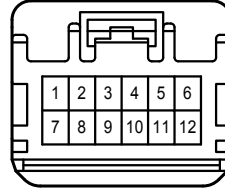

L 92

White

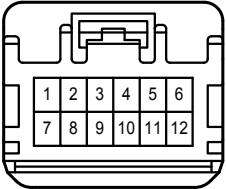

2A

White

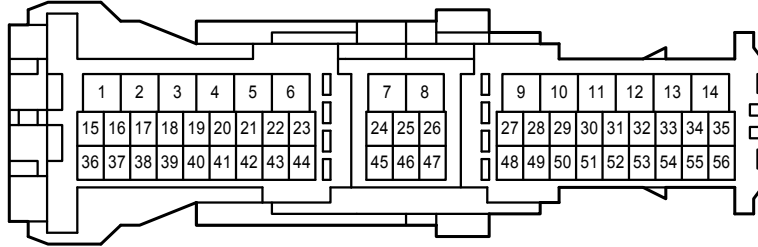

2C

White

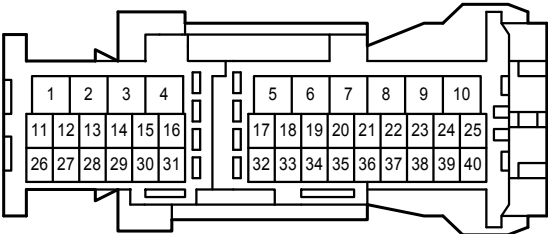

AL4

Black

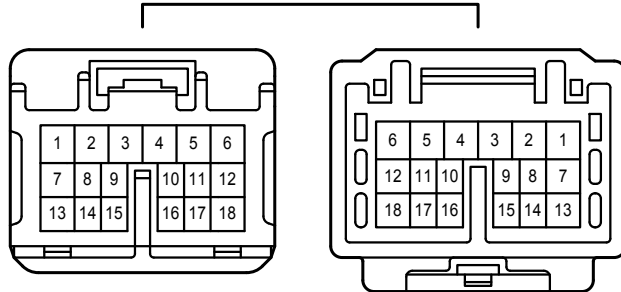

**Ground Point**

\* 2 : LED Type  
 \* 3 : Except LED Type

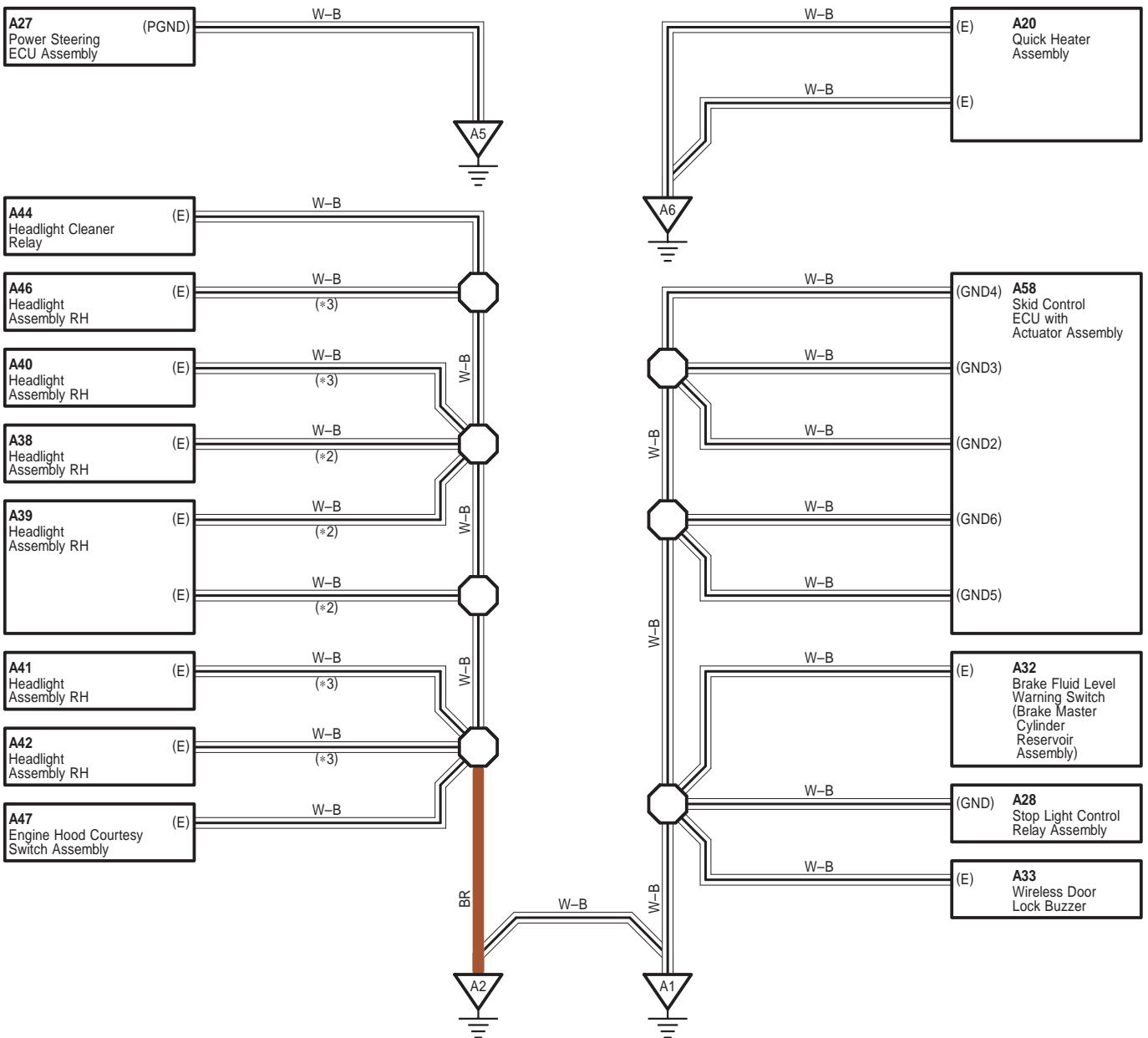

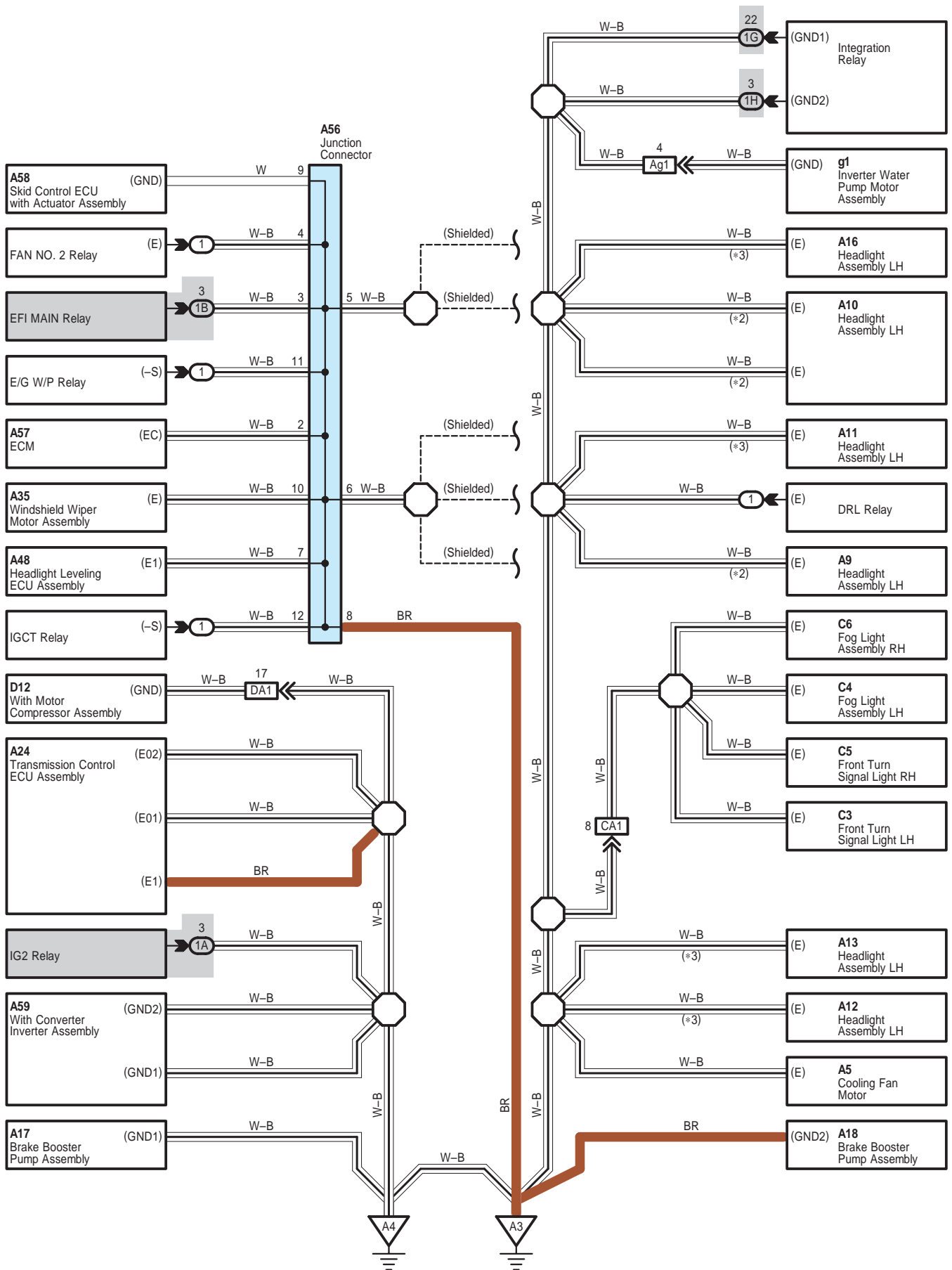

Ground Point

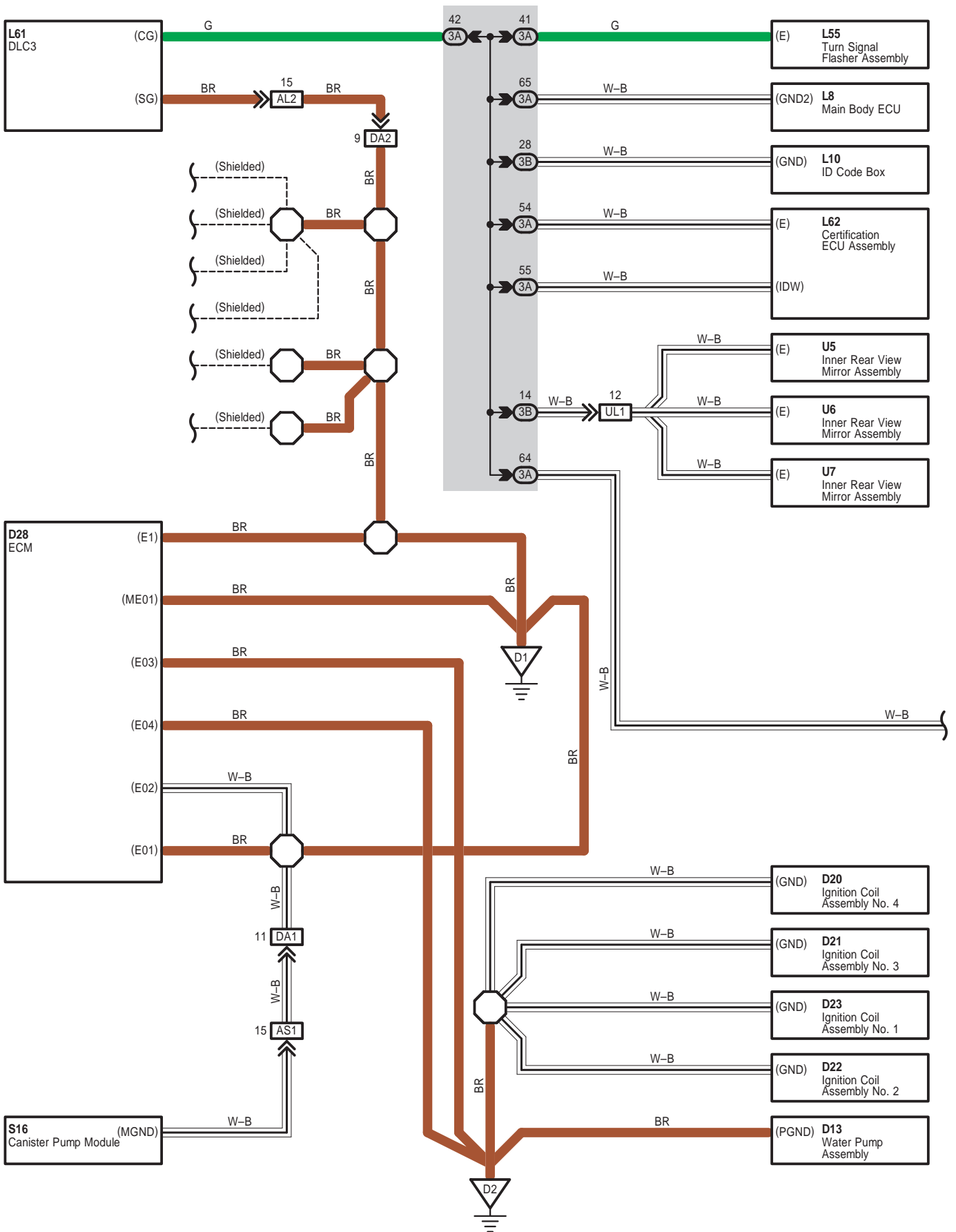

## Ground Point

- \* 1 : w/ Dynamic Radar Cruise Control
- \* 9 : Except Korea
- \*10 : w/ Stereo Component Amplifier
- \*11 : w/o Stereo Component Amplifier
- \*12 : w/o Navigation System
- \*13 : w/ Navigation System

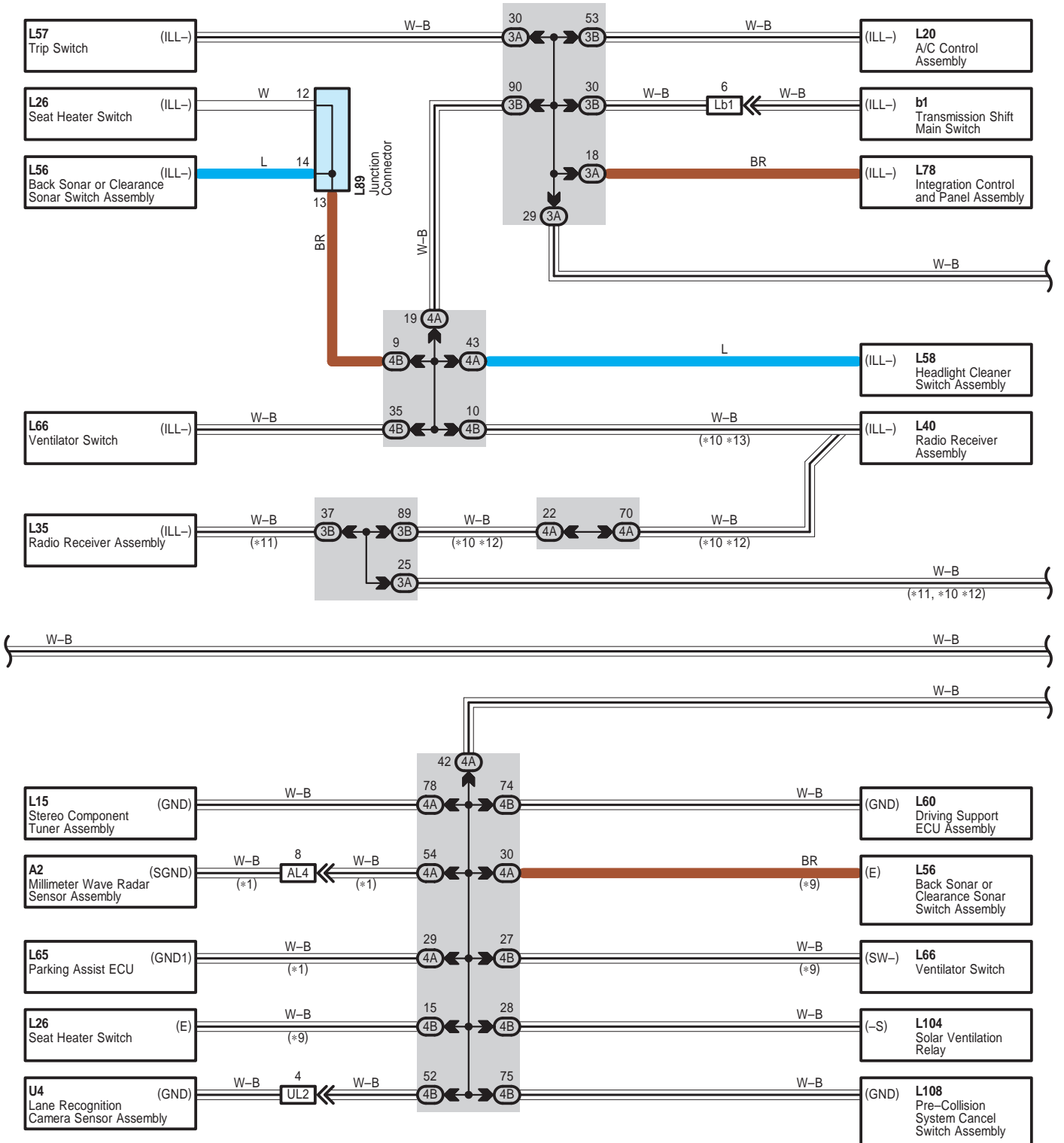

# Ground Point

- \* 8 : Korea
- \* 9 : Except Korea
- \* 4 : w/ Sliding Roof
- \* 5 : w/o Sliding Roof
- \* 10 : w/ Stereo Component Amplifier
- \* 11 : w/o Stereo Component Amplifier
- \* 12 : w/o Navigation System

When wiring colors are indicated with (\*\*), either the colored wiring (general wiring) or the painted wiring is used.

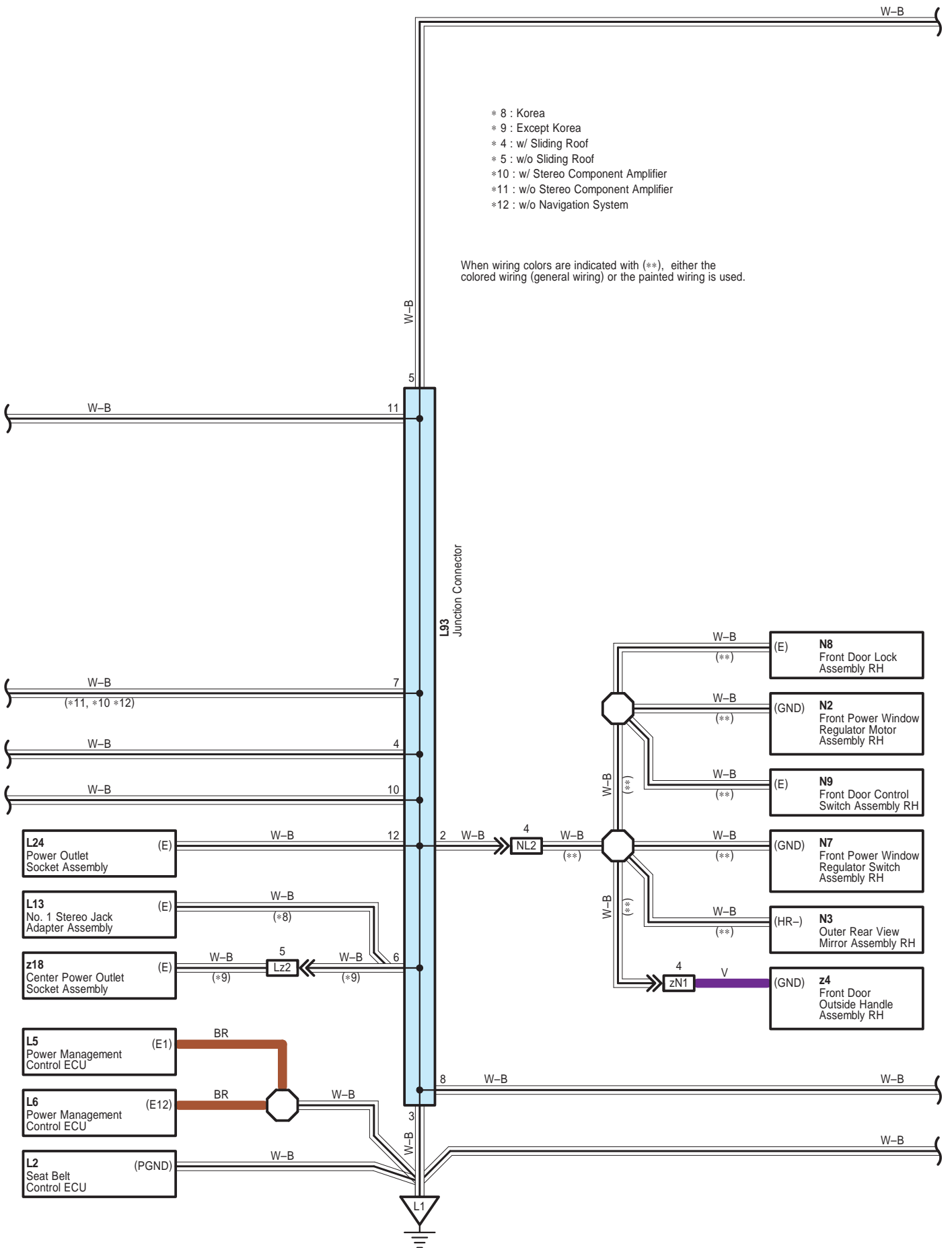



Ground Point

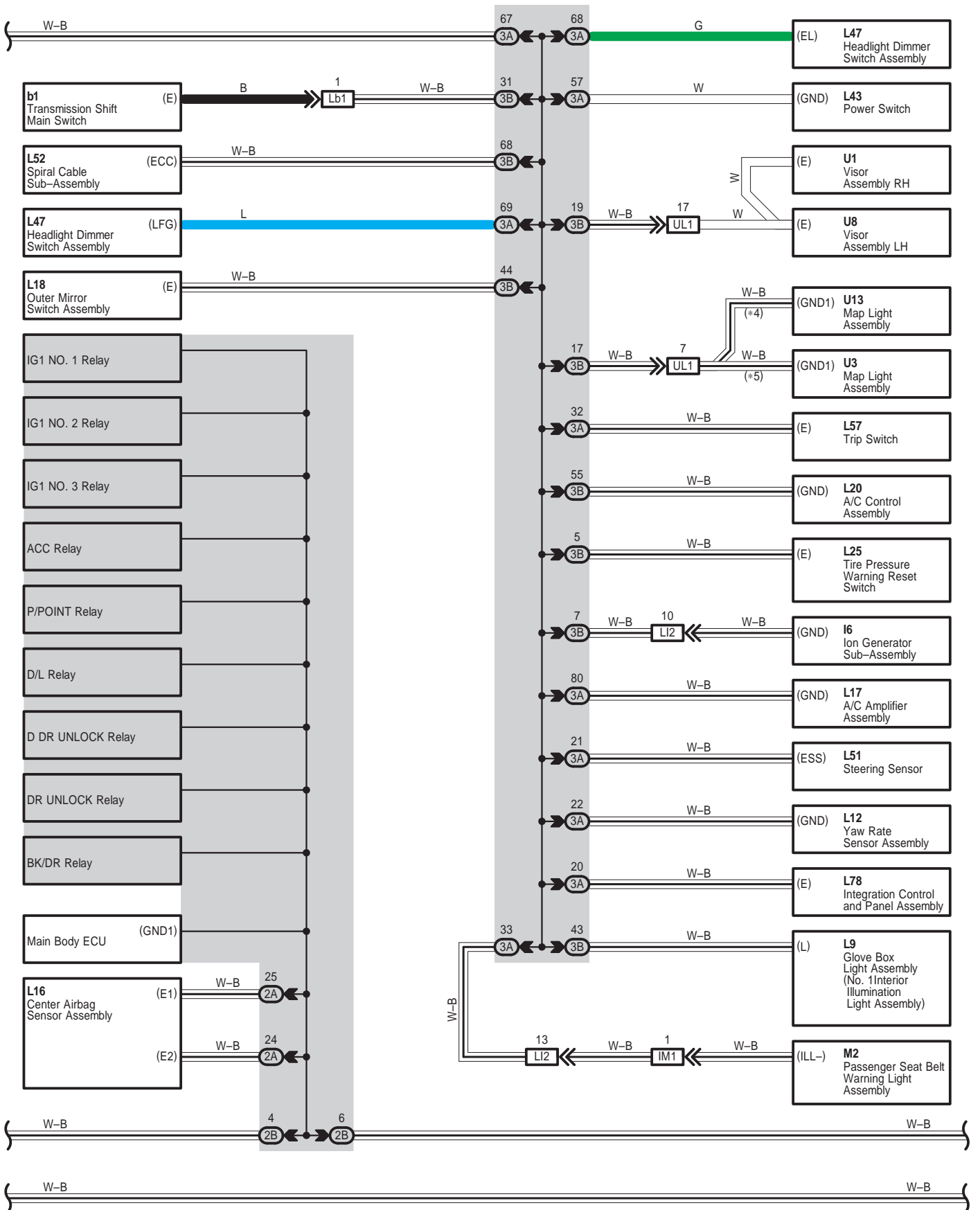

## Ground Point

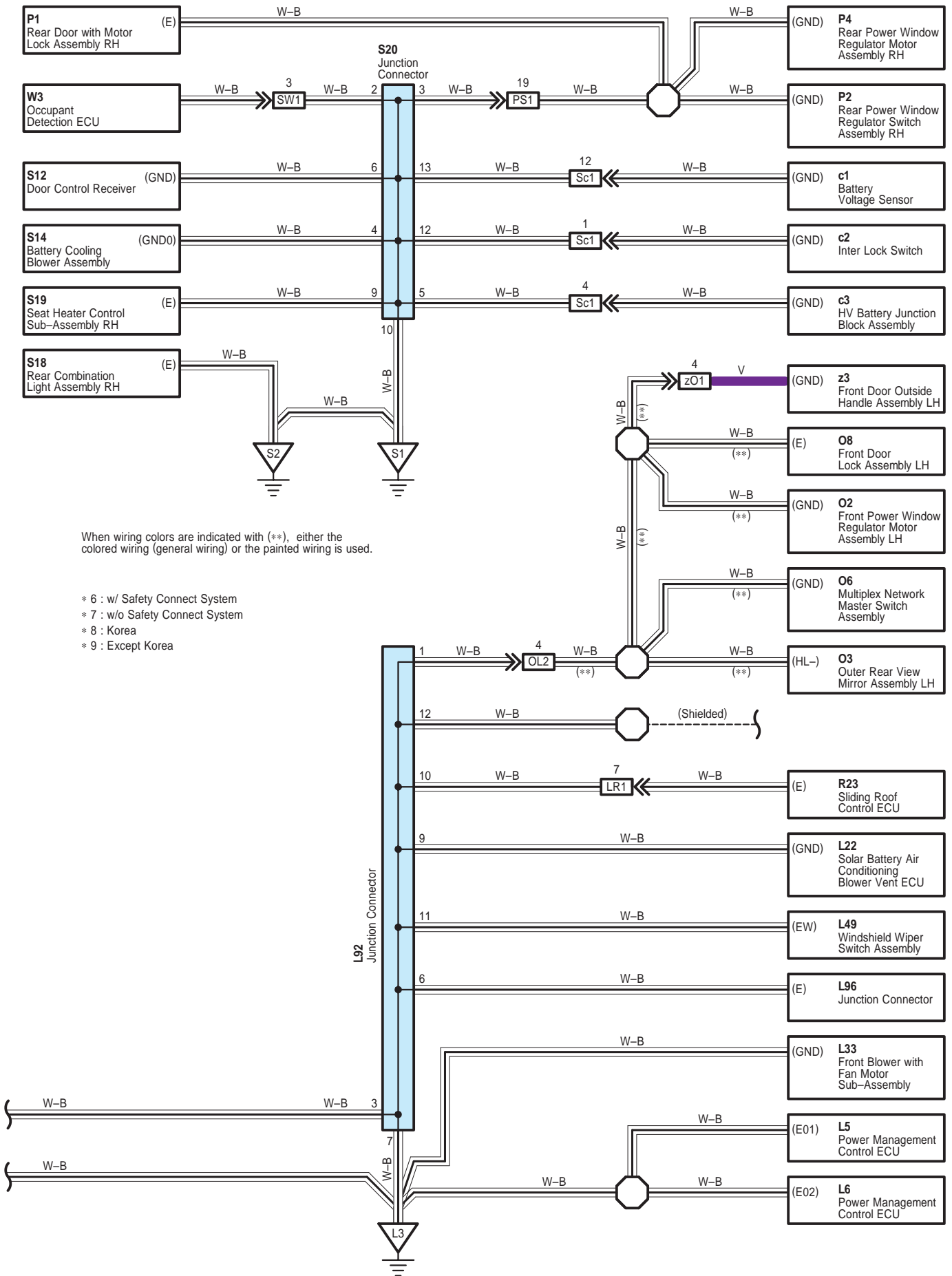

When wiring colors are indicated with (\*\*), either the colored wiring (general wiring) or the painted wiring is used.

- \* 6 : w/ Safety Connect System
- \* 7 : w/o Safety Connect System
- \* 8 : Korea
- \* 9 : Except Korea

**Ground Point**

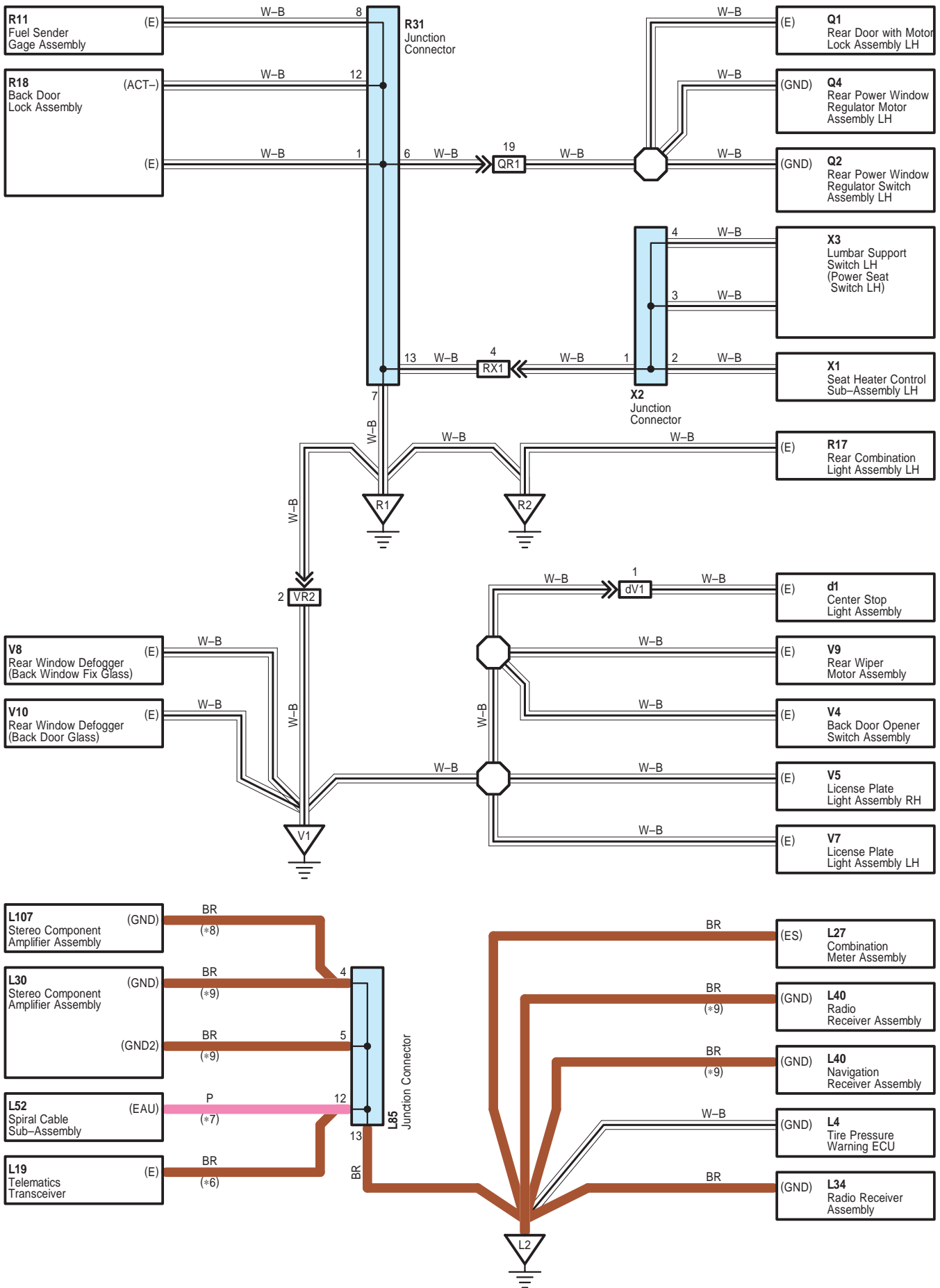

Ground Point

A 56  
White

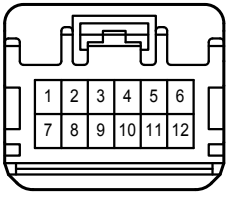

L 85  
White

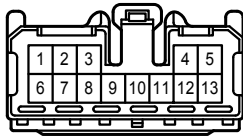

L 89  
Black

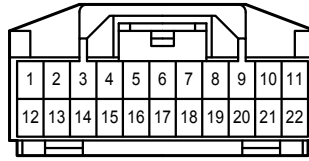

L 92  
White

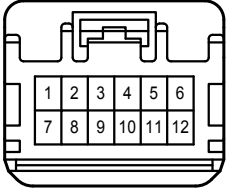

L 93  
White

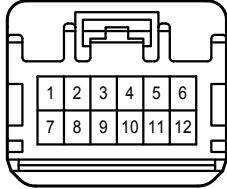

R 31  
White

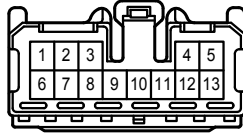

S 20  
White

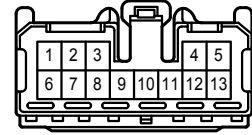

X 2  
Black

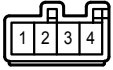

1A  
White

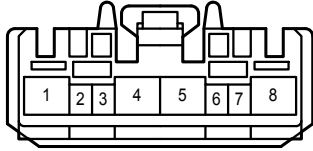

1B  
White

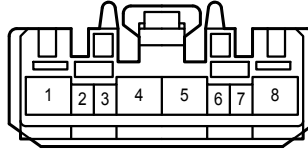

1G  
White

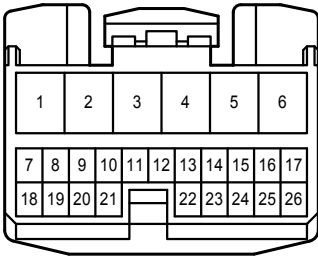

1H  
White

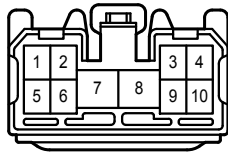

2A  
White

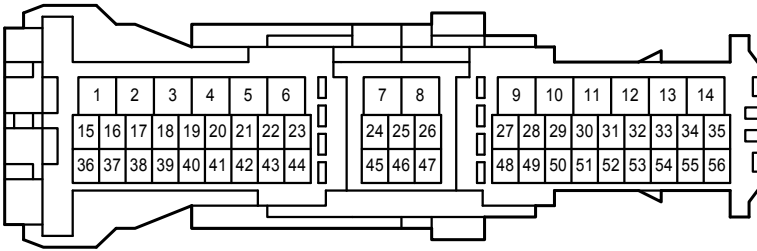

2B  
White

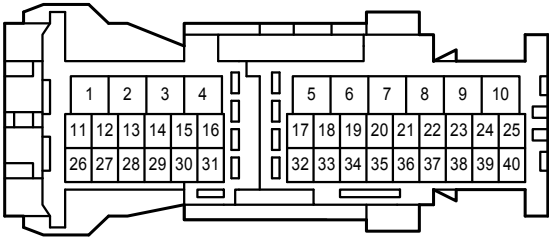

3A  
White

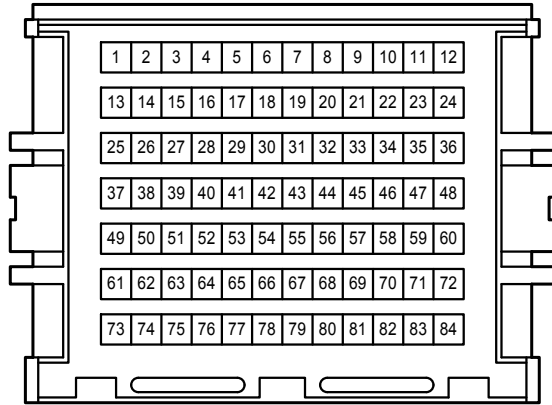

3B  
White

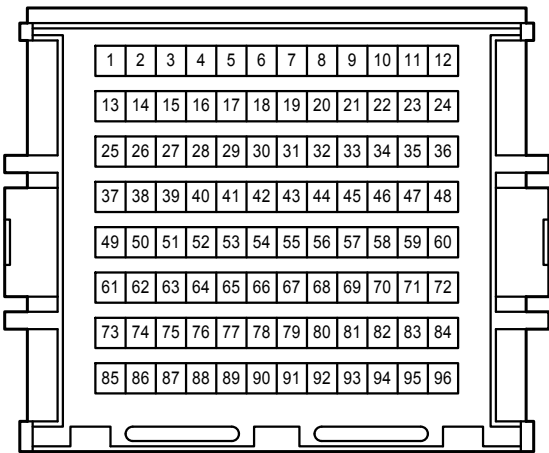

4A  
White

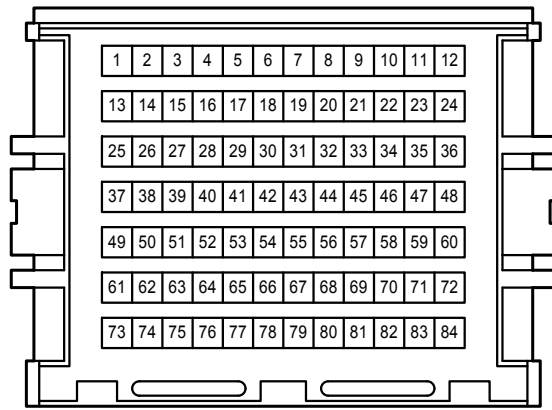

4B  
White

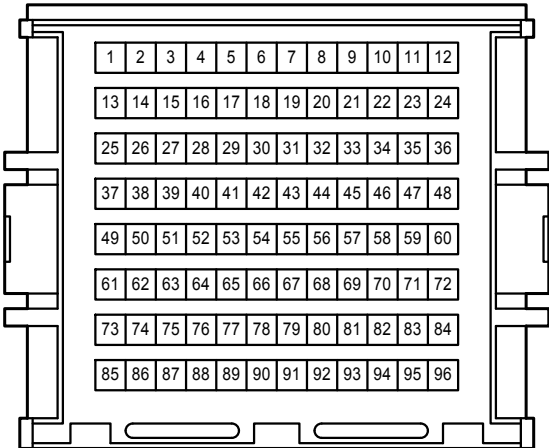

AL2  
Gray

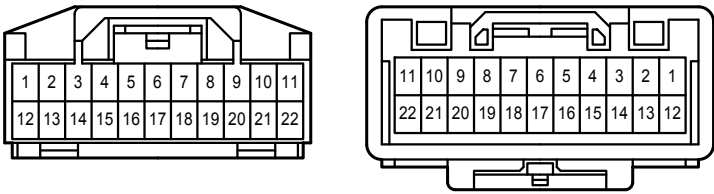

AL4  
Black

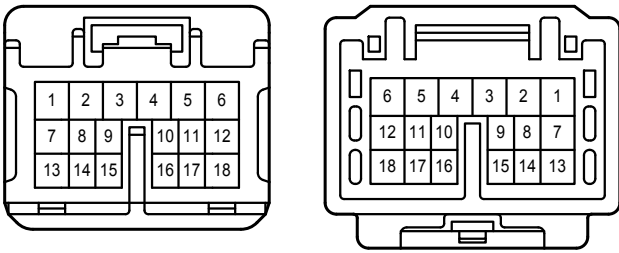

AS1  
White

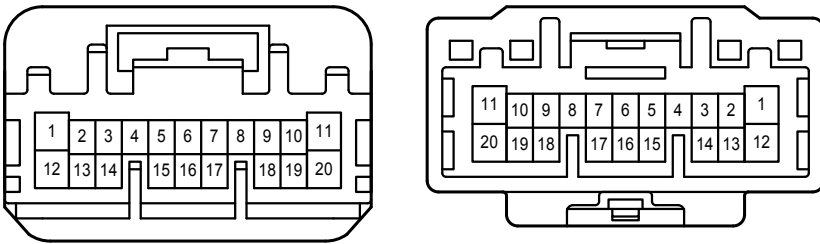

Ag1  
Black

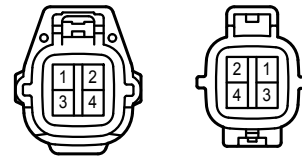

CA1  
Black

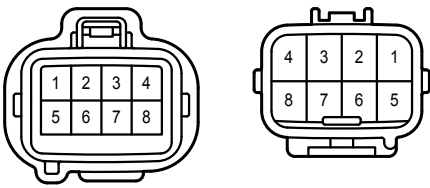

DA1  
White

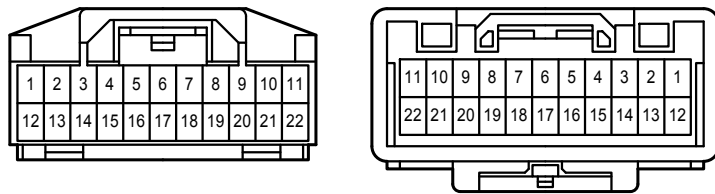

DA2  
White

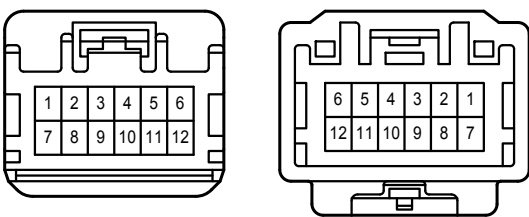

IM1  
White

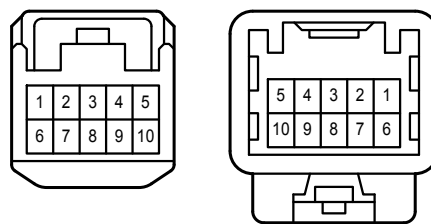

LI2  
White

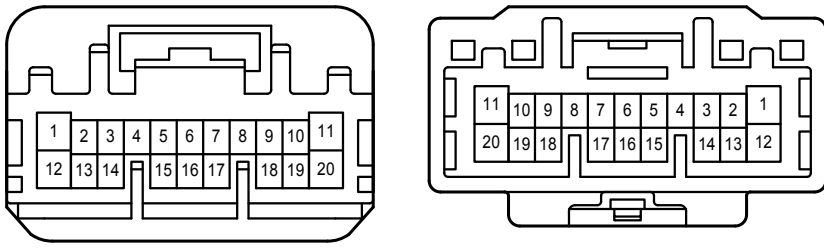

LR1  
White

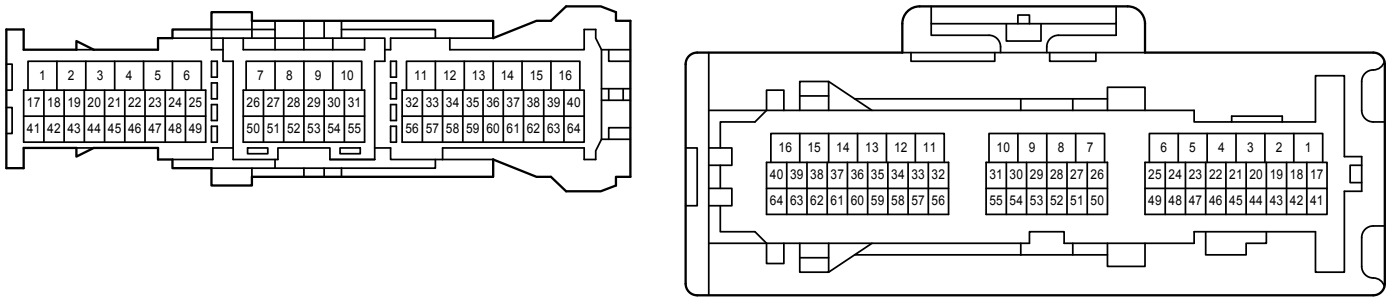

Lb1  
White

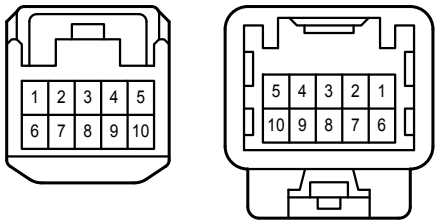

Lz2  
White

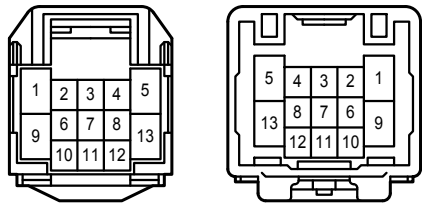

NL2  
White

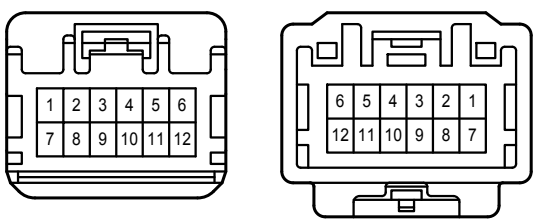

OL2  
White

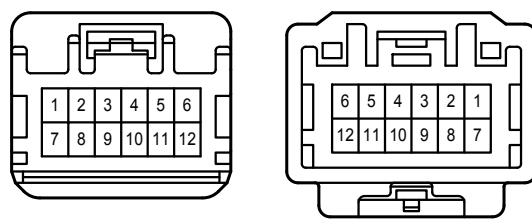

Ground Point

PS1  
White

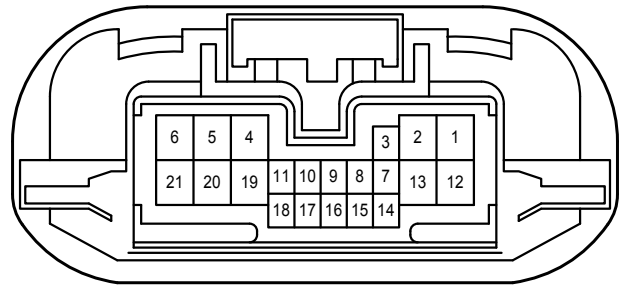
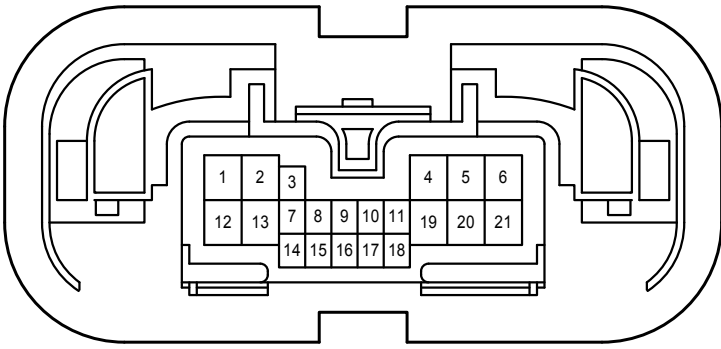

QR1  
White

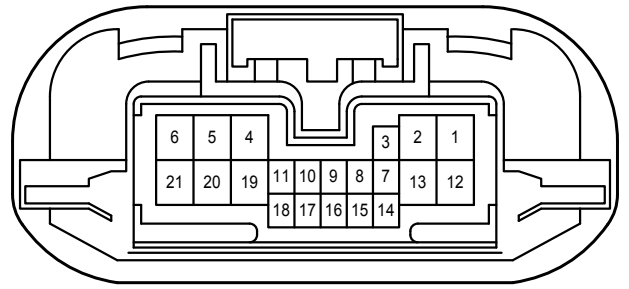
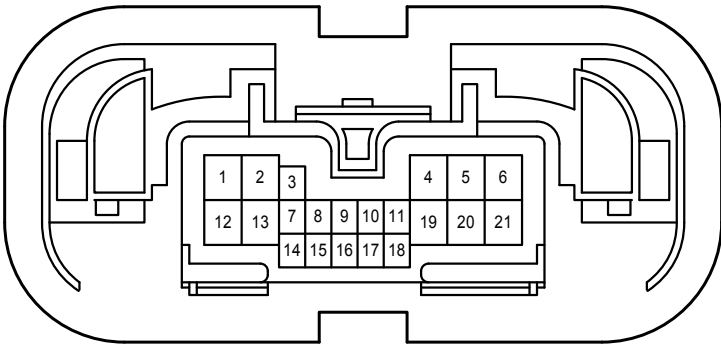

RX1  
White

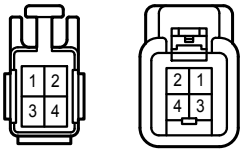

SW1  
Gray

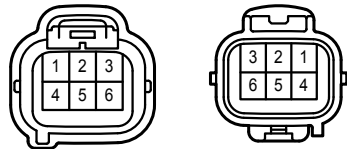

Sc1  
White

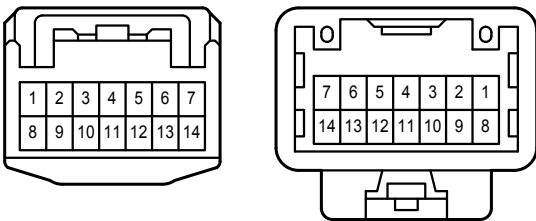

UL1  
Gray

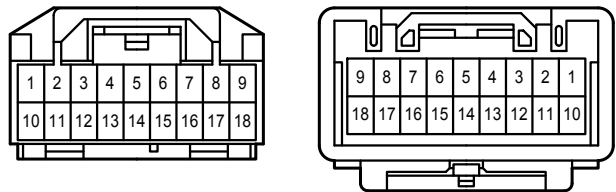



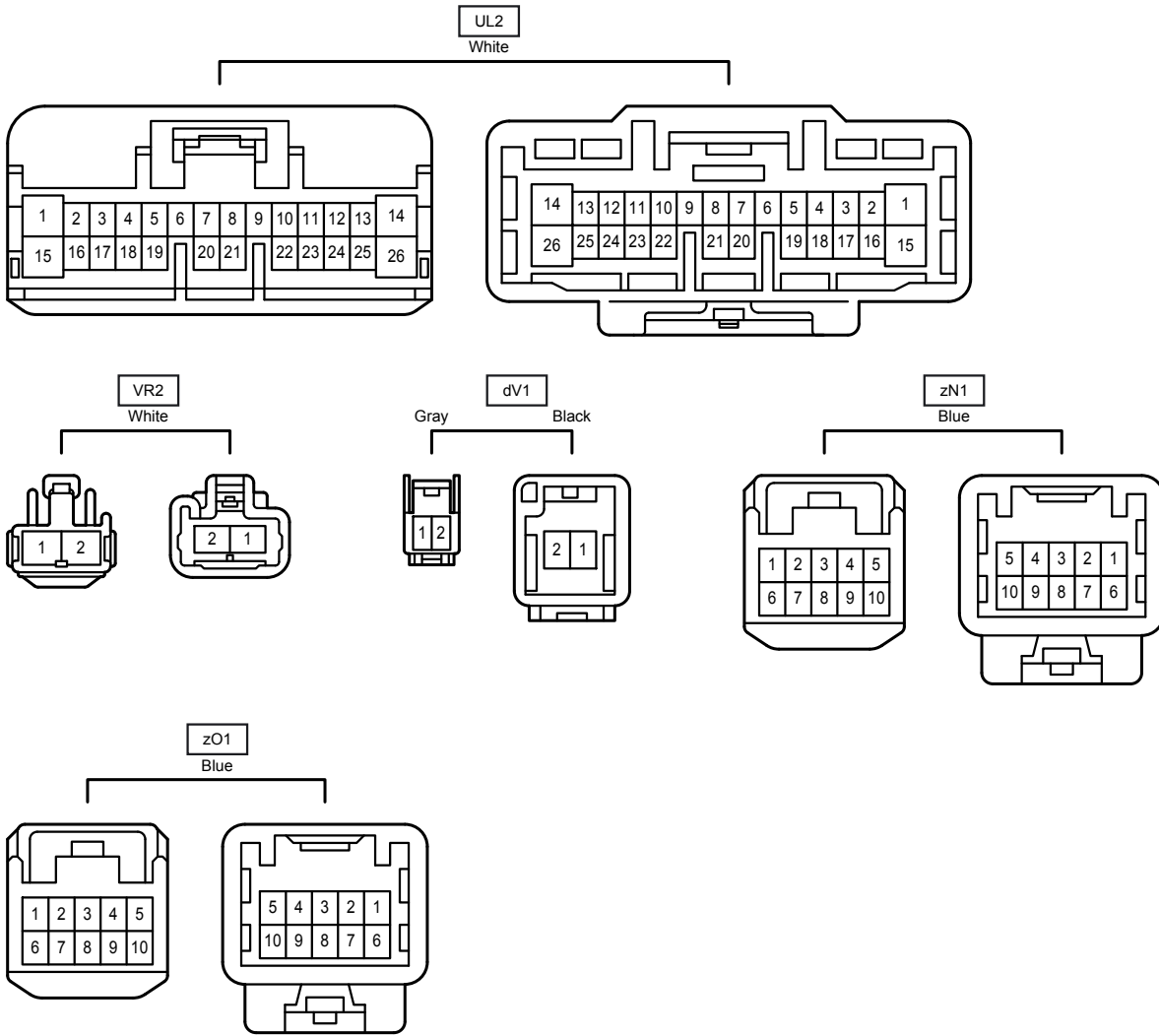



# Headlight Beam Level Control

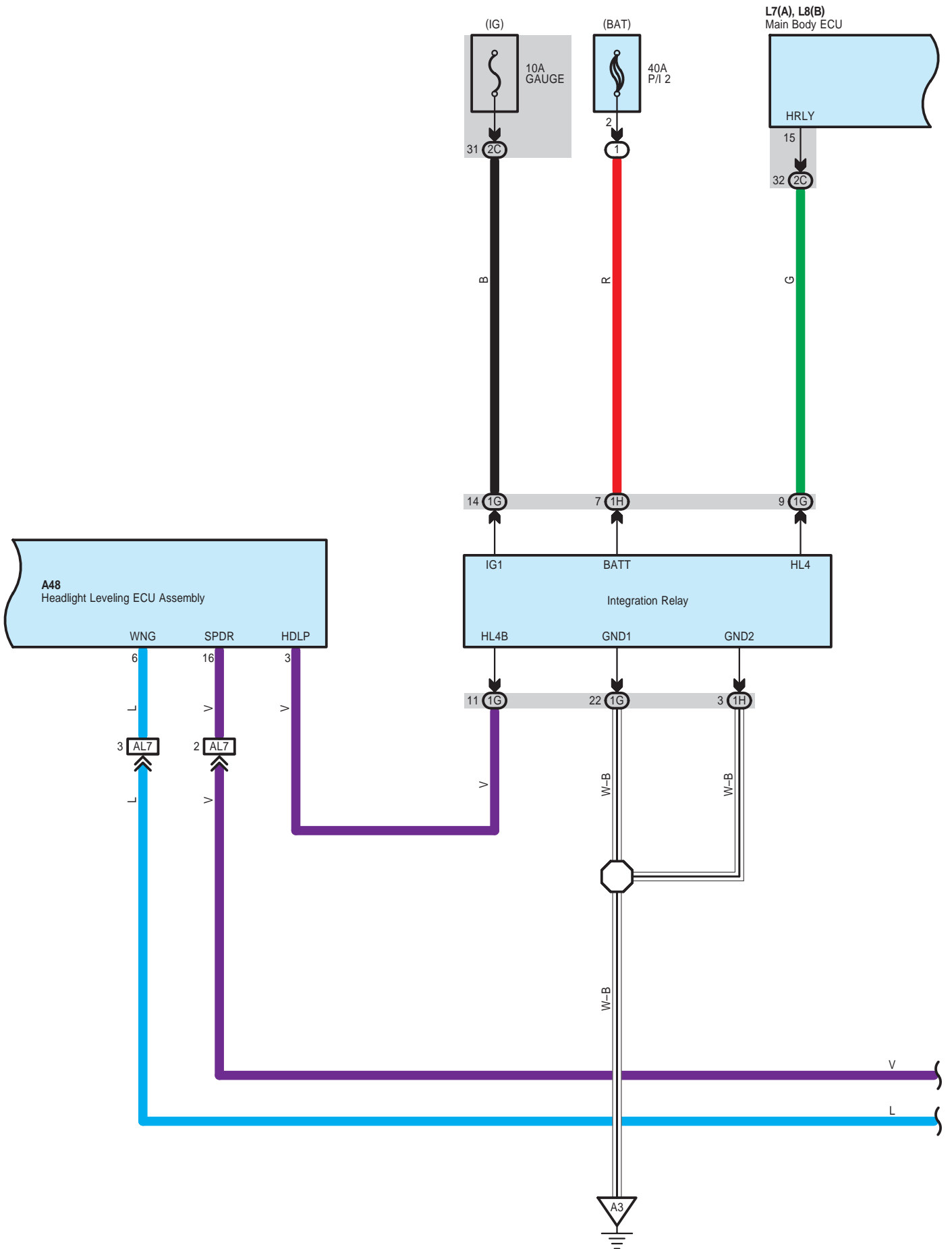

# Headlight Beam Level Control

L7(A), L8(B)  
Main Body ECU

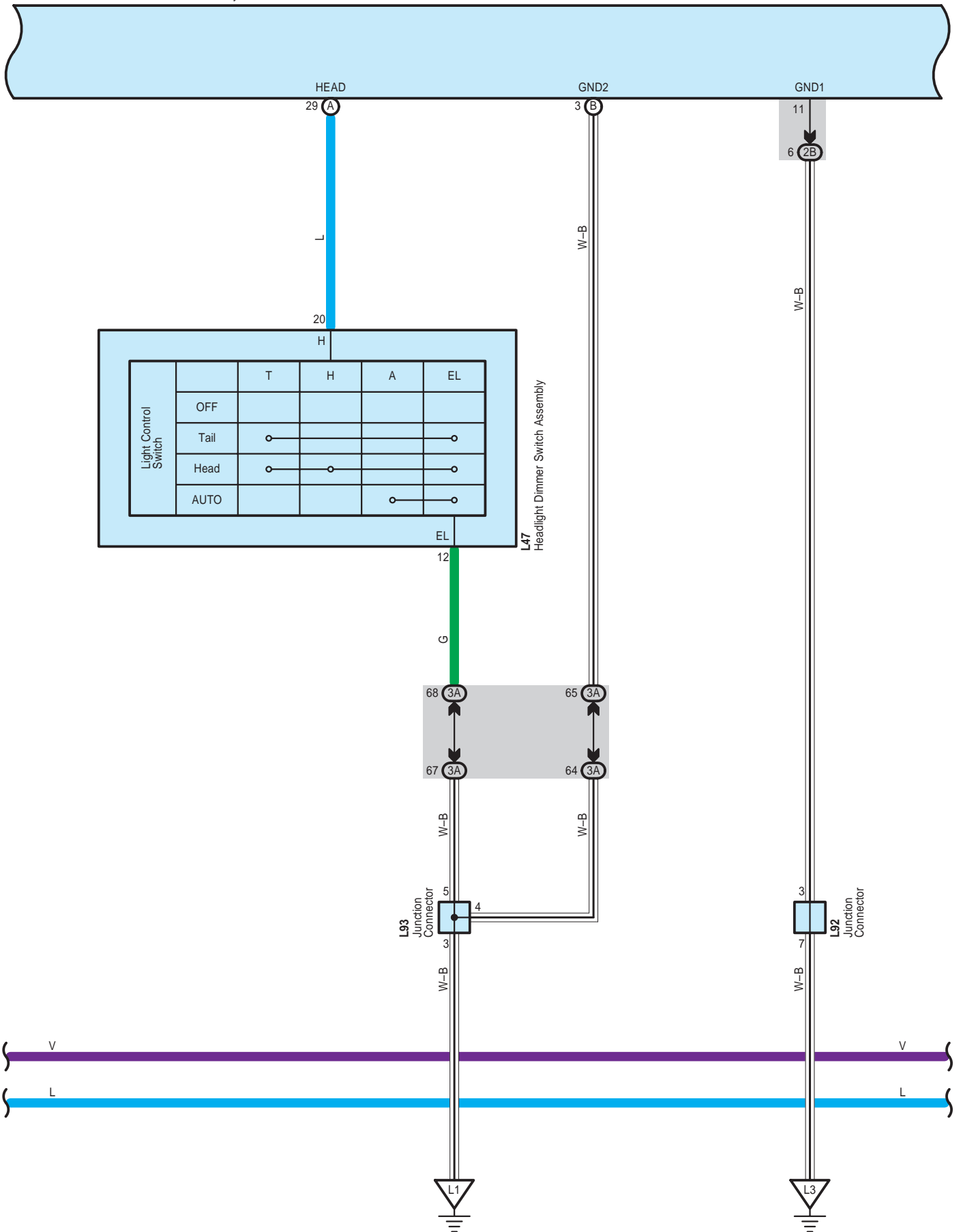

## Headlight Beam Level Control

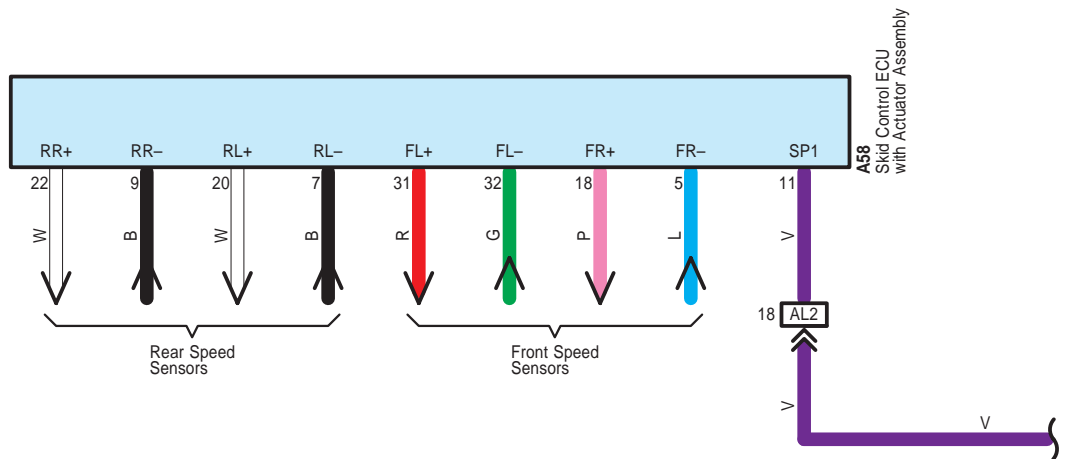
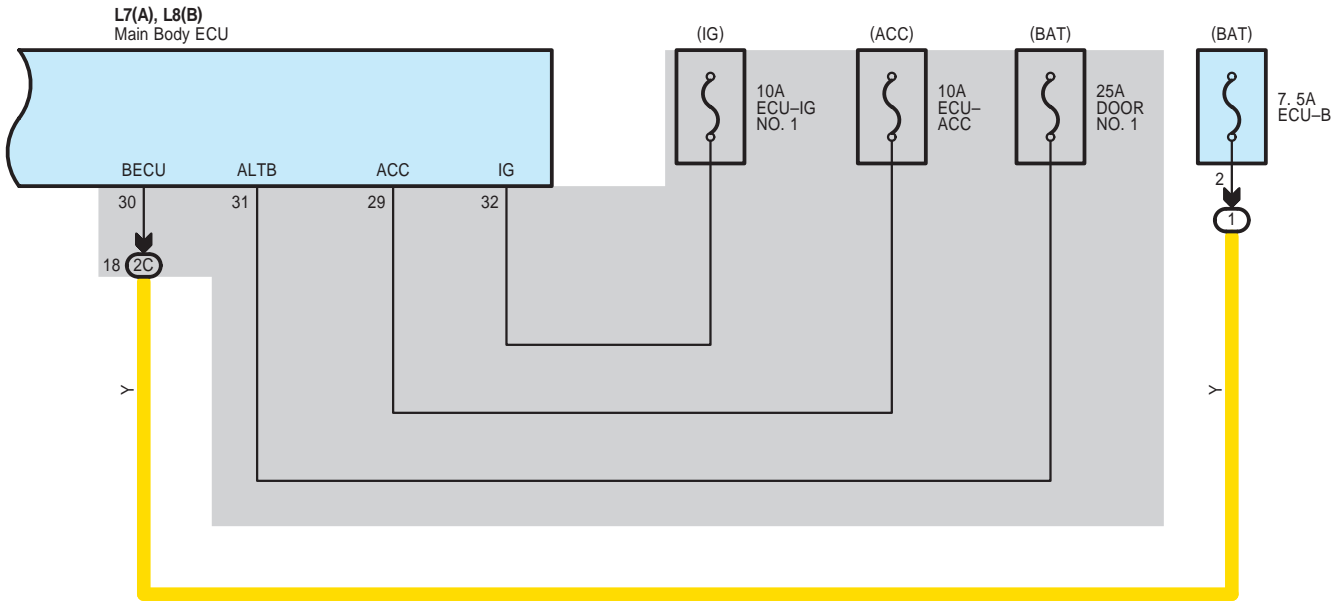

# Headlight Beam Level Control

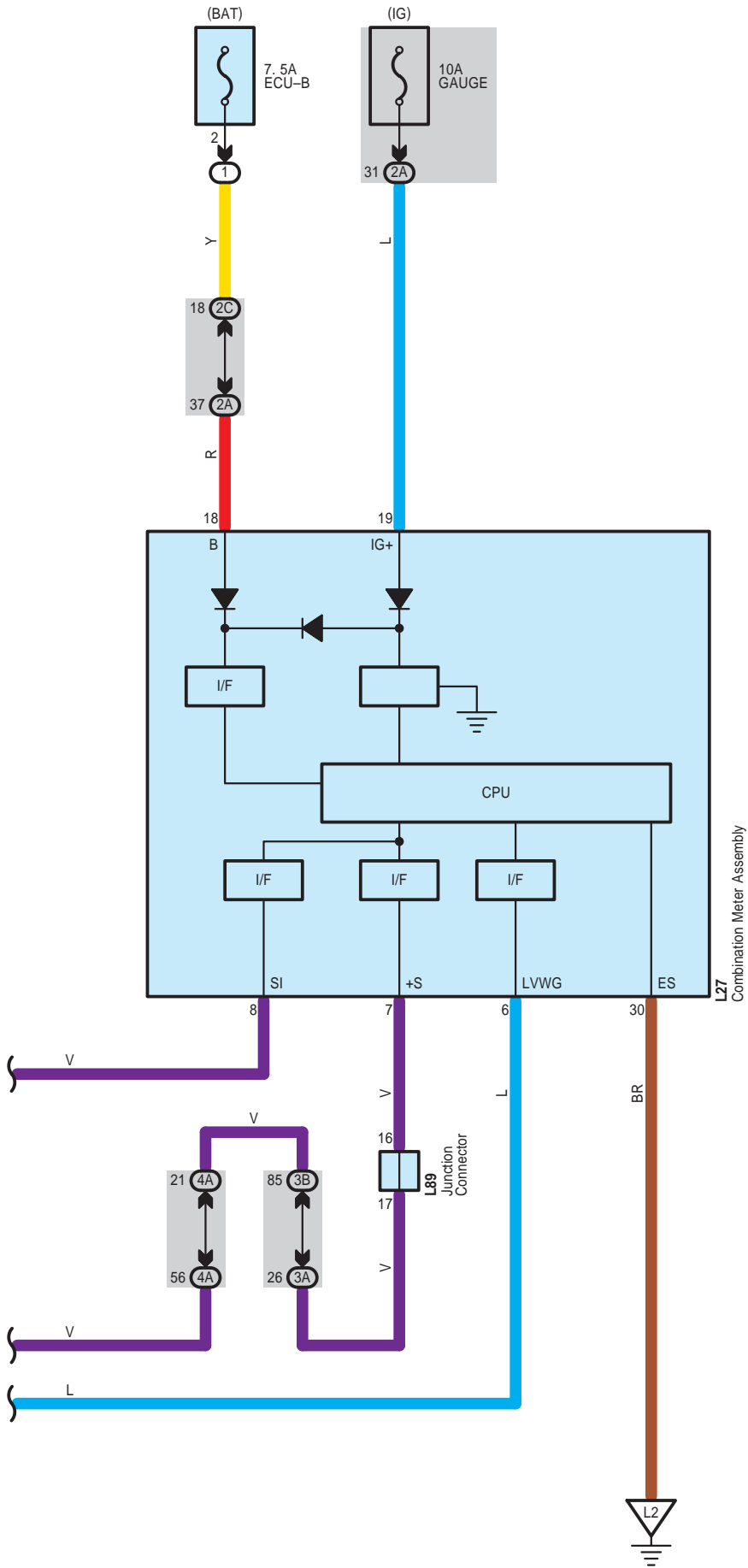

Headlight Beam Level Control

A 14  
Gray

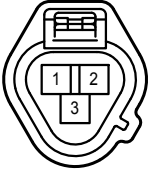

A 48  
White

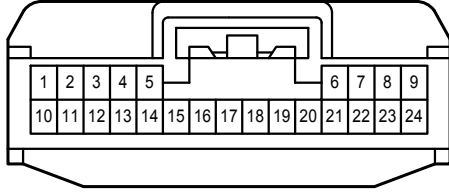

A 49  
Gray



A 56  
White

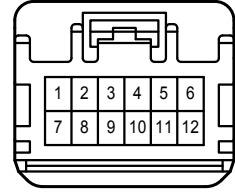

A 58  
Gray

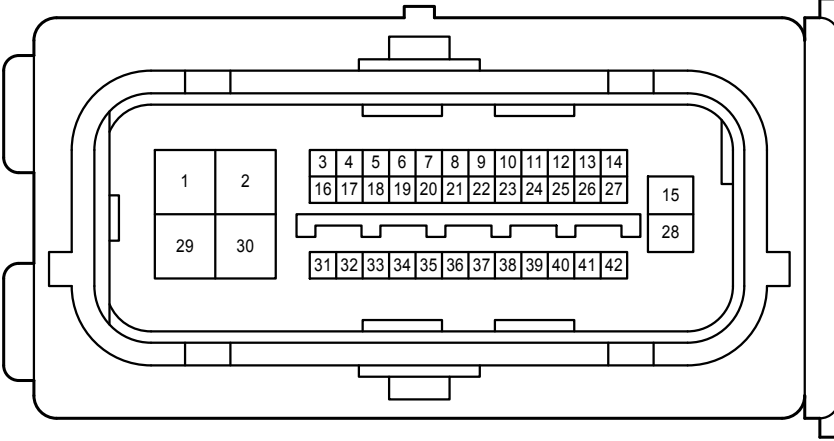

L 7  
White

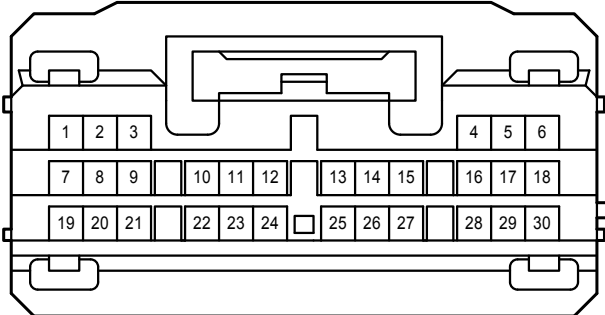

L 8  
White

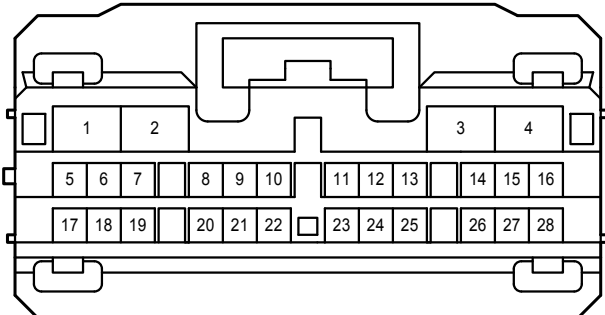

L 27  
White

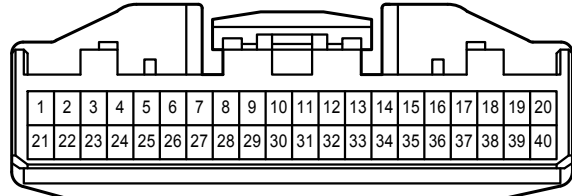

# Headlight Beam Level Control

L 47  
White

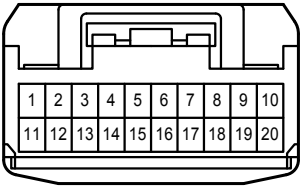

L 61  
White

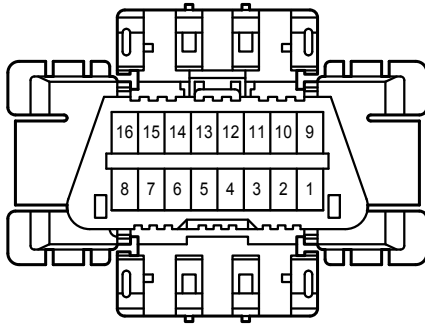

L 65  
White

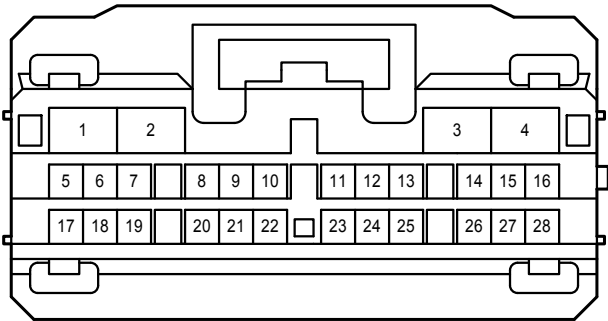

L 89  
Black

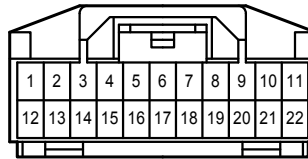

L 92  
White

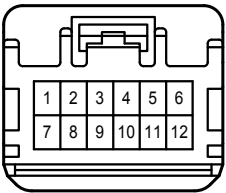

L 93  
White

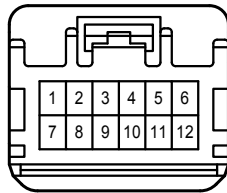

S 3  
Black

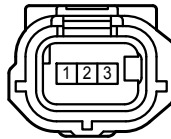

1G  
White

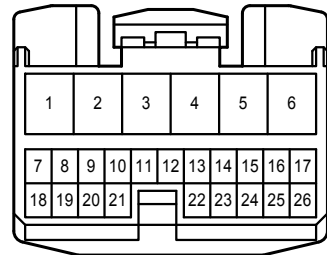

1H  
White

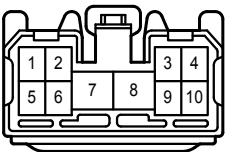

2A  
White

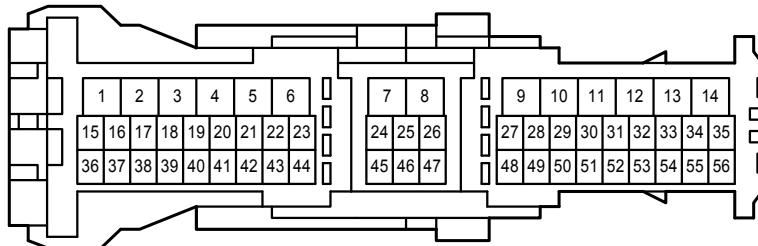

2B  
White

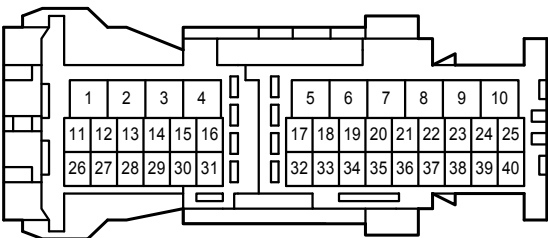

2C  
White

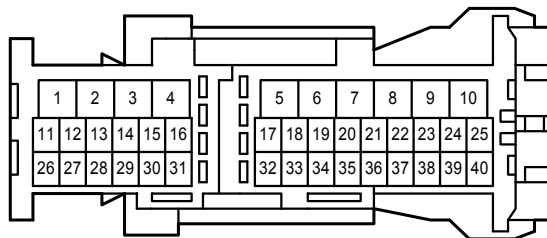



Headlight Beam Level Control

3A  
White

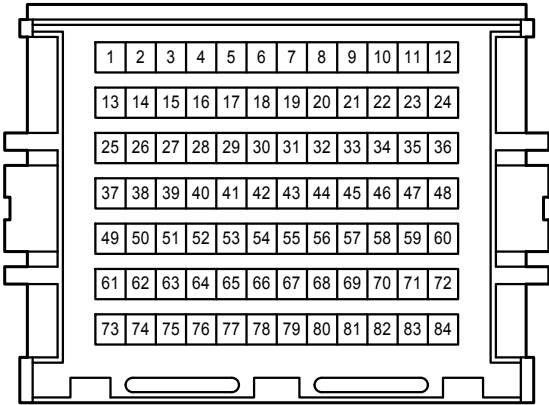

3B  
White

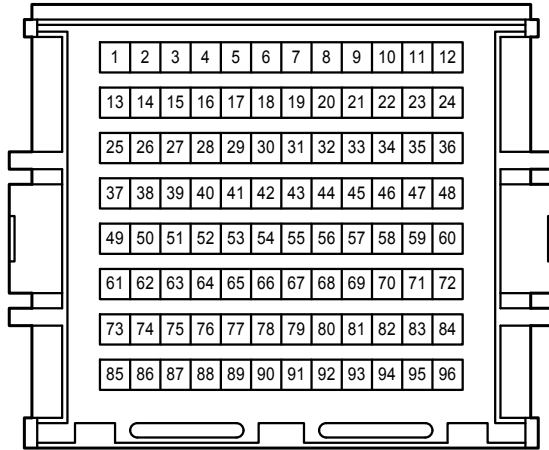

4A  
White

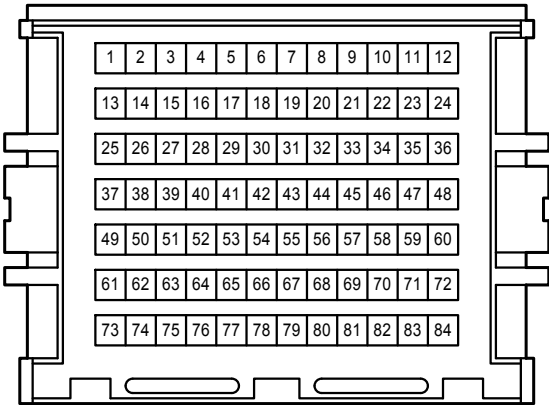

AL2  
Gray

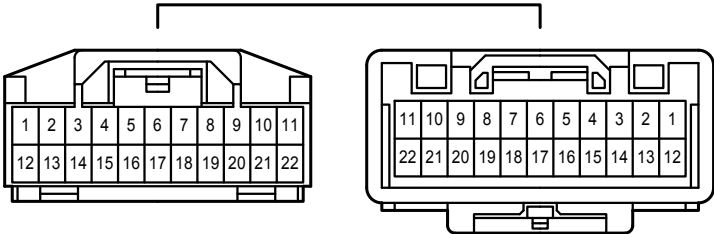

AL7  
Black

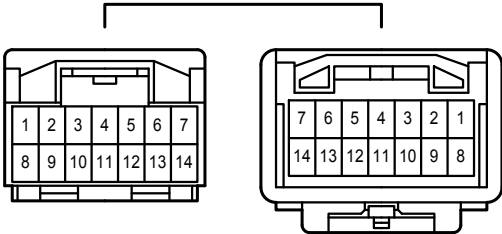

# Headlight Beam Level Control

LS1  
White

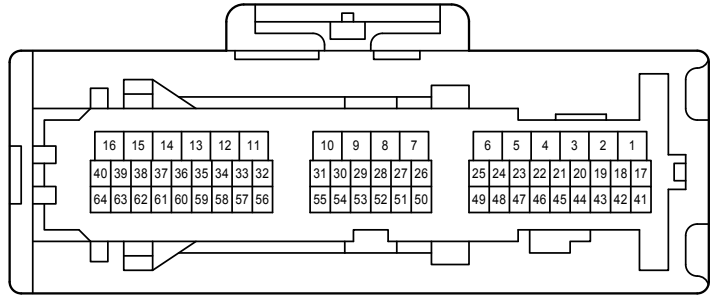
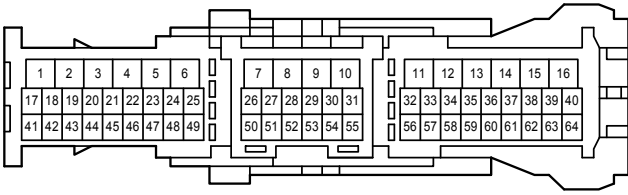



# Headlight Cleaner

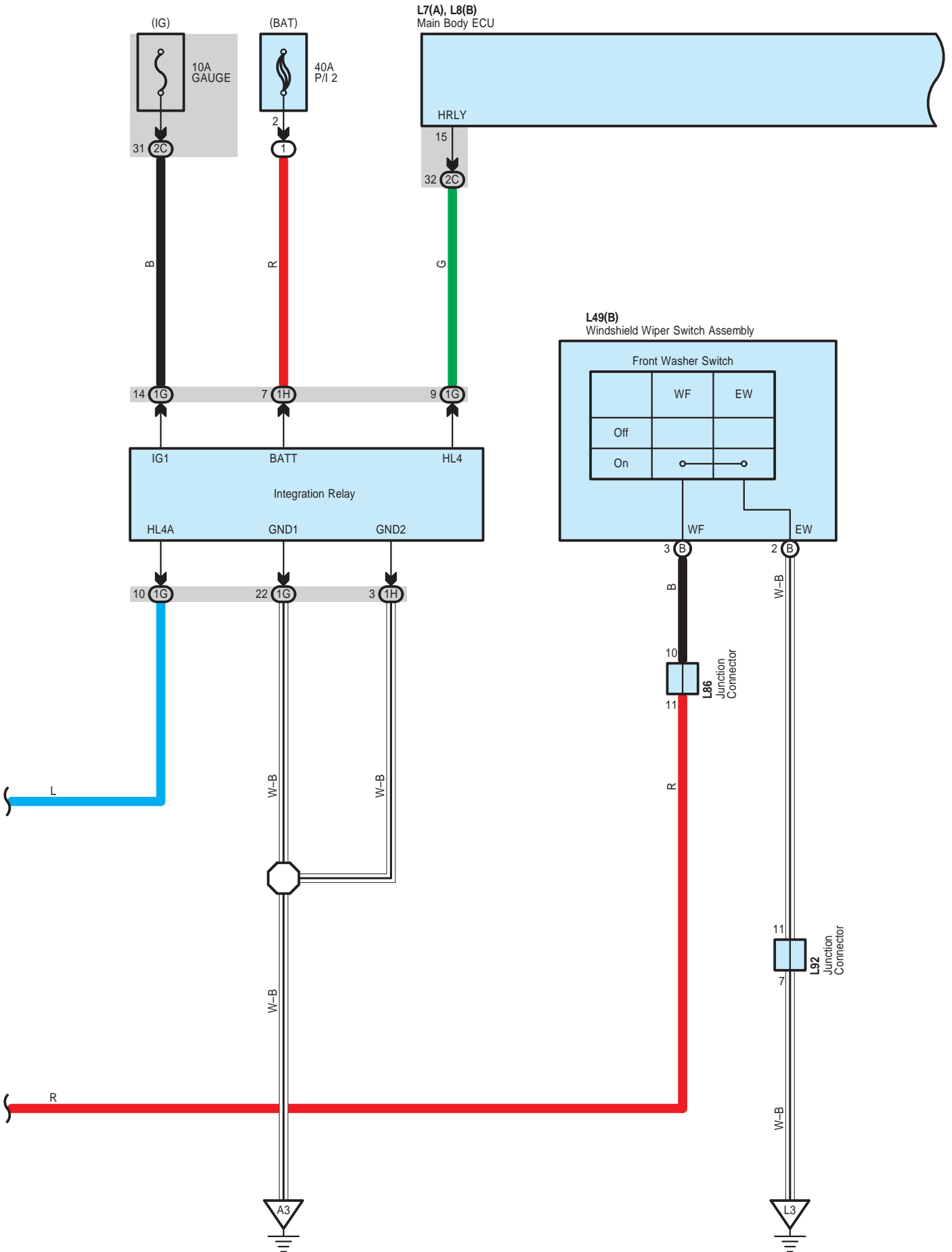

# Headlight Cleaner

L7(A), L8(B)  
Main Body ECU

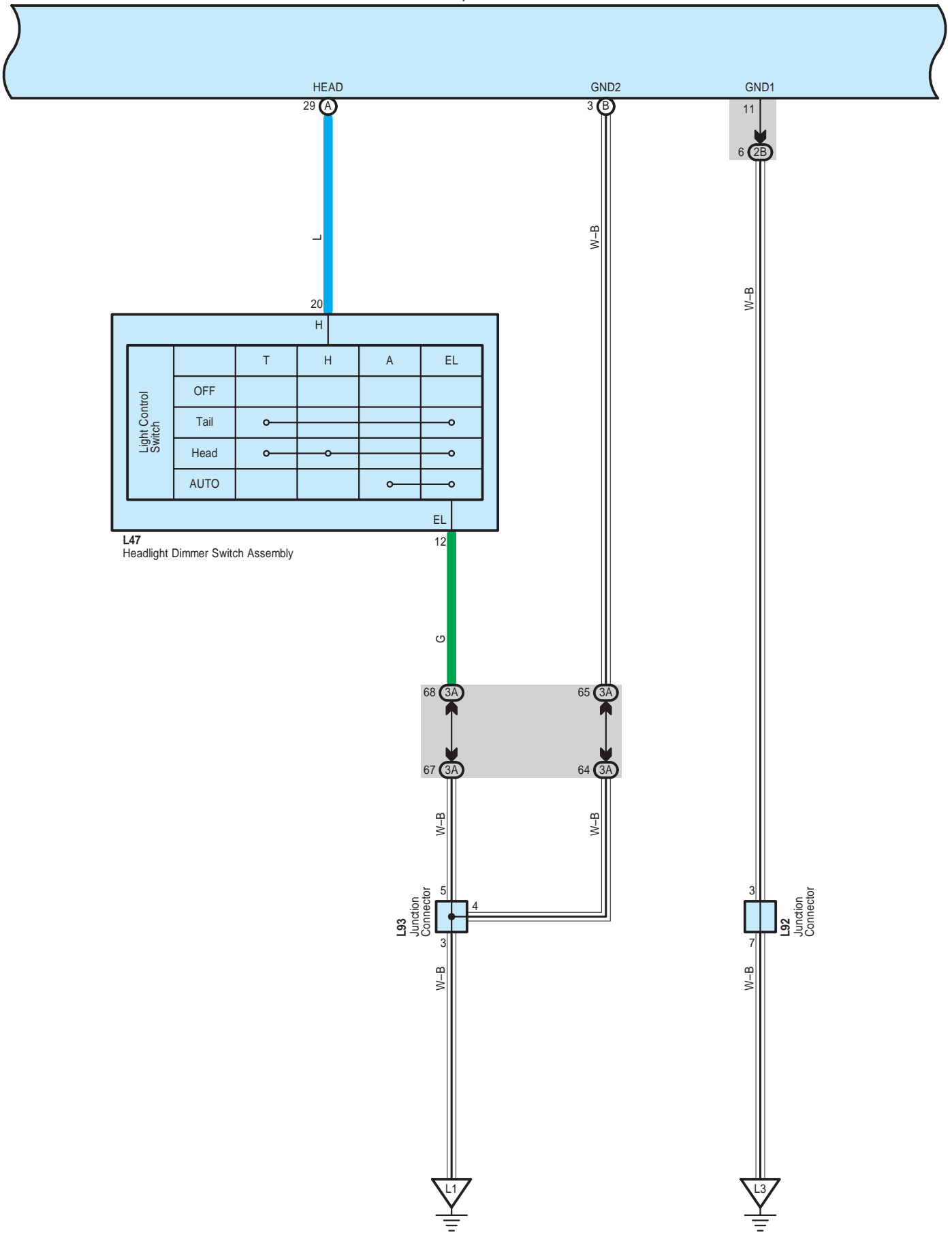

# Headlight Cleaner

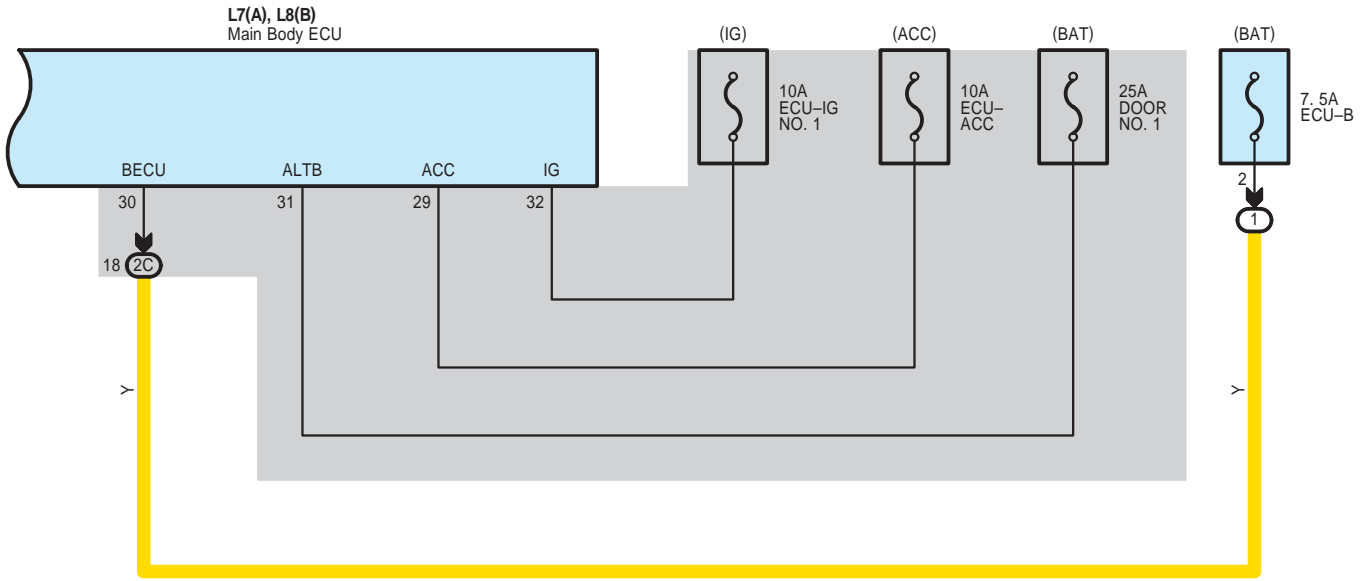

Headlight Cleaner

A 43

Black

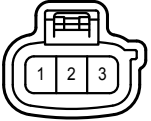

A 44

Gray

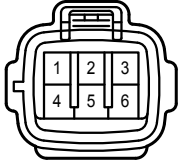

A 54

Black

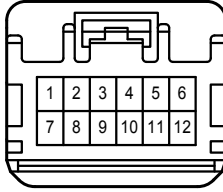

A 55

Black

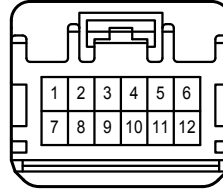

L 7

White

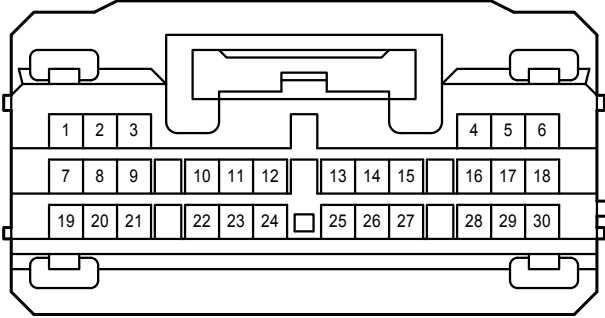

L 8

White

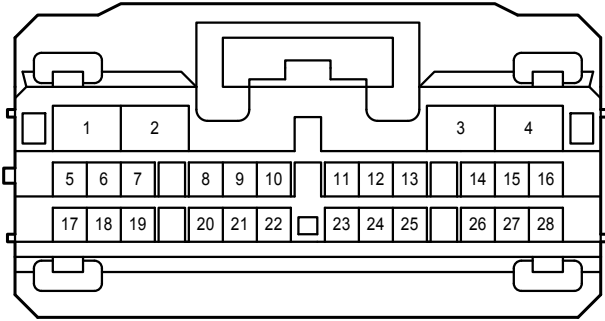

L 47

White

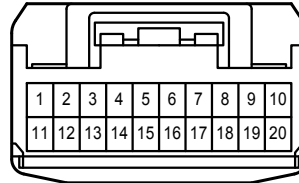

L 49

White

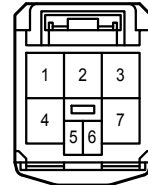

L 58

Gray

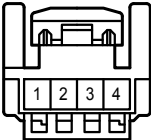

L 86

Black

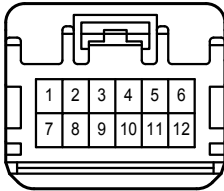

L 92

White

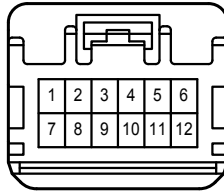

L 93

White

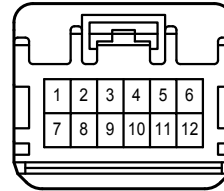

1G

White

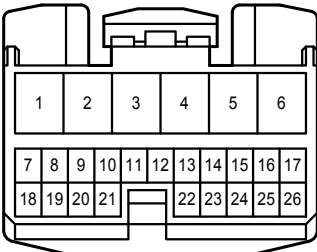

1H

White

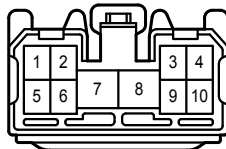

Headlight Cleaner

2B  
White

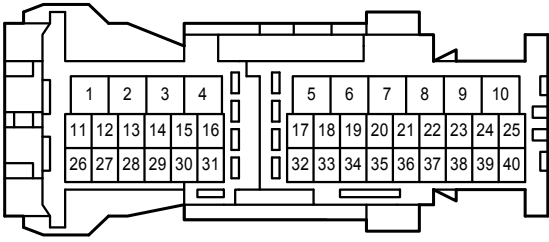

2C  
White

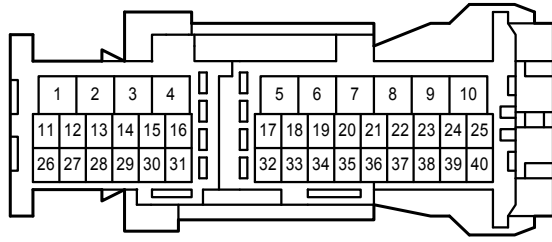

3A  
White

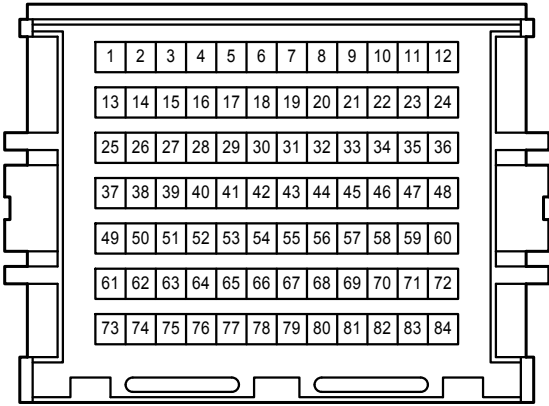

AL8  
White

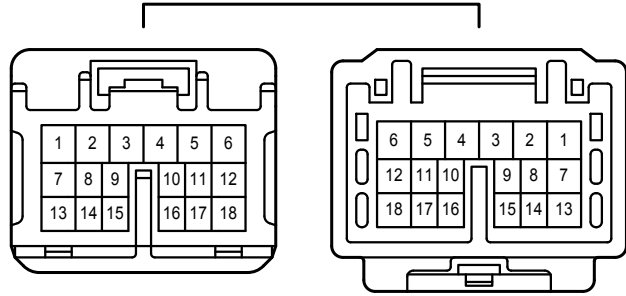





# Headlight

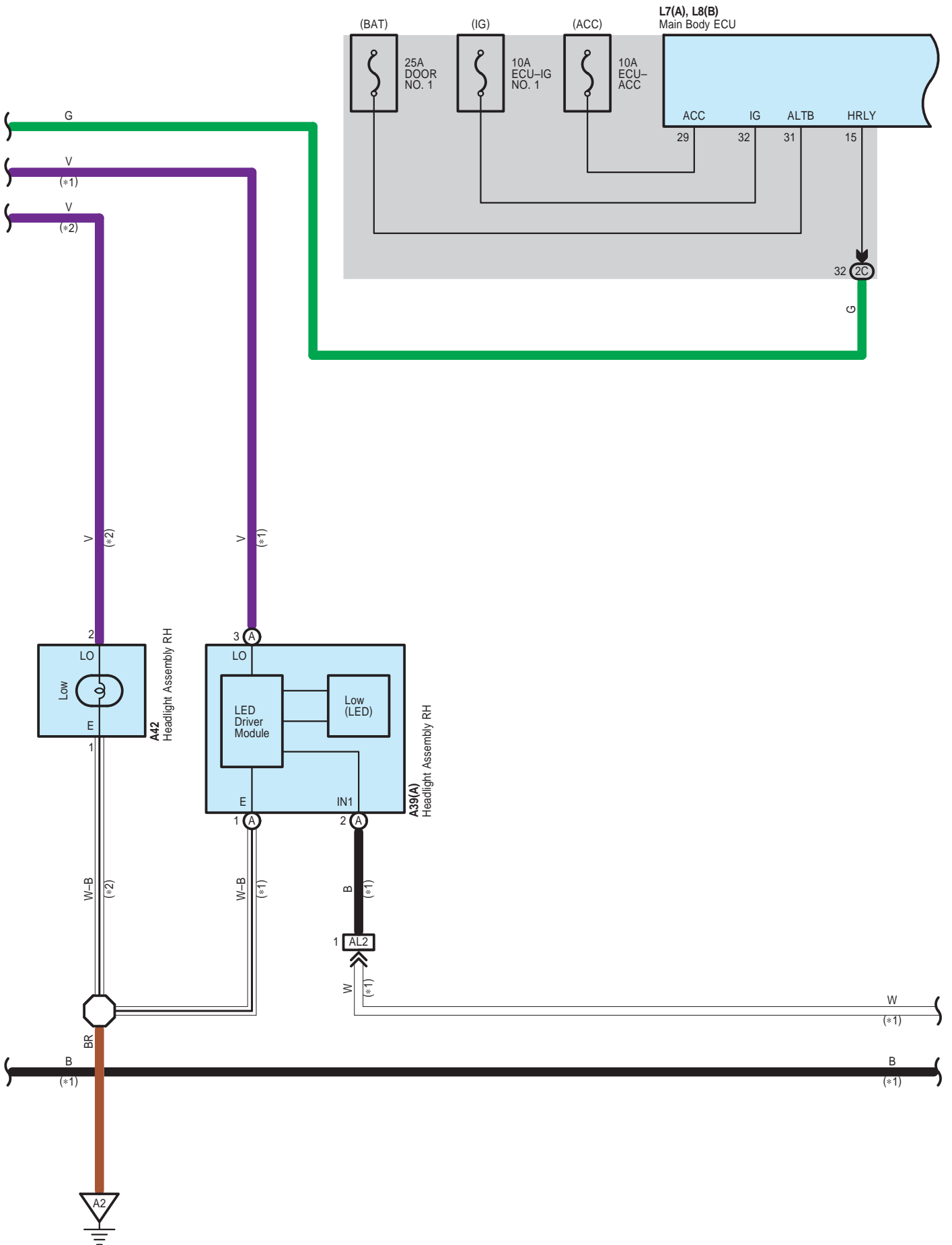



# Headlight

L7(A), L8(B)  
Main Body ECU

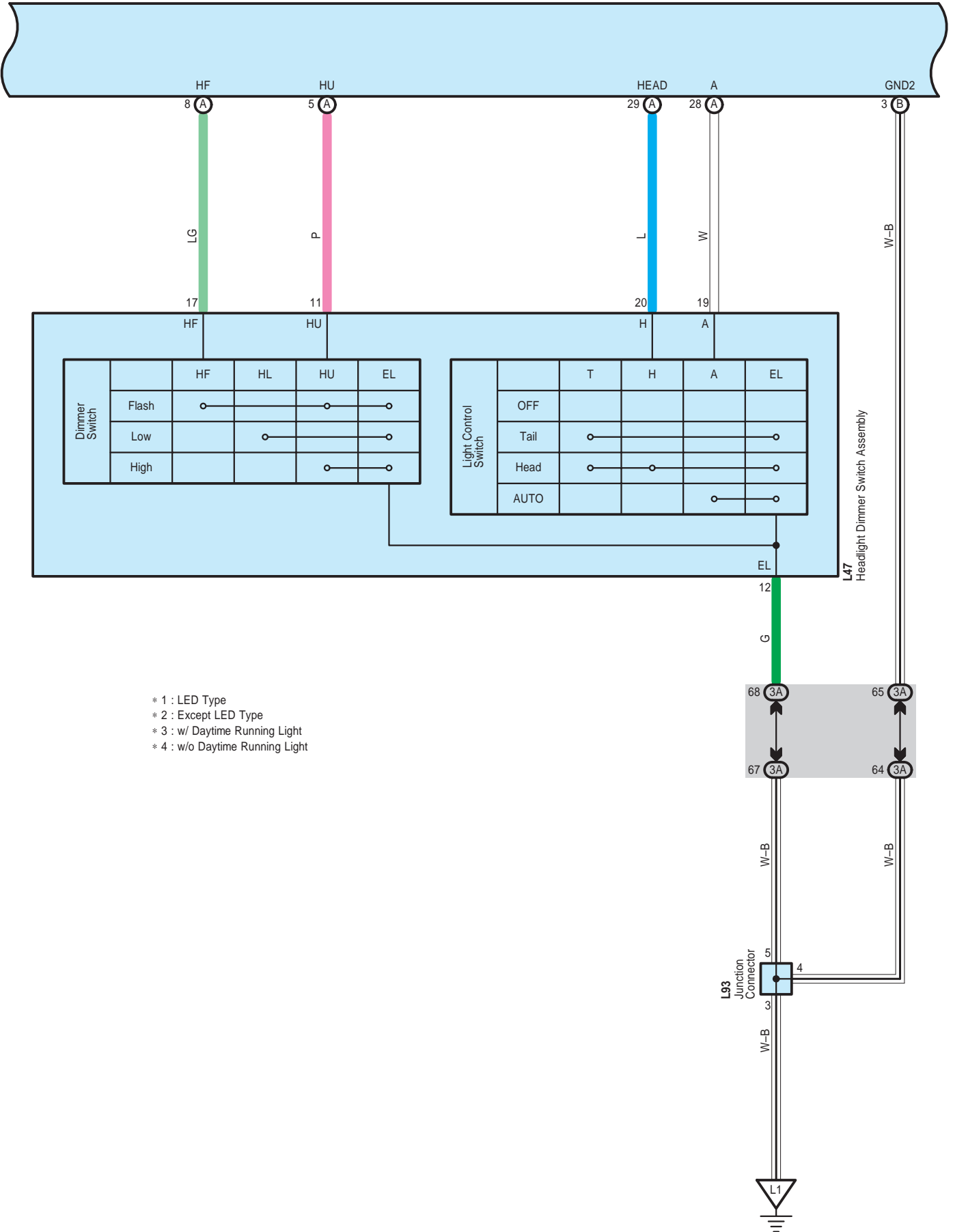

- \* 1 : LED Type
- \* 2 : Except LED Type
- \* 3 : w/ Daytime Running Light
- \* 4 : w/o Daytime Running Light

# Headlight

L7(A), L8(B)  
Main Body ECU

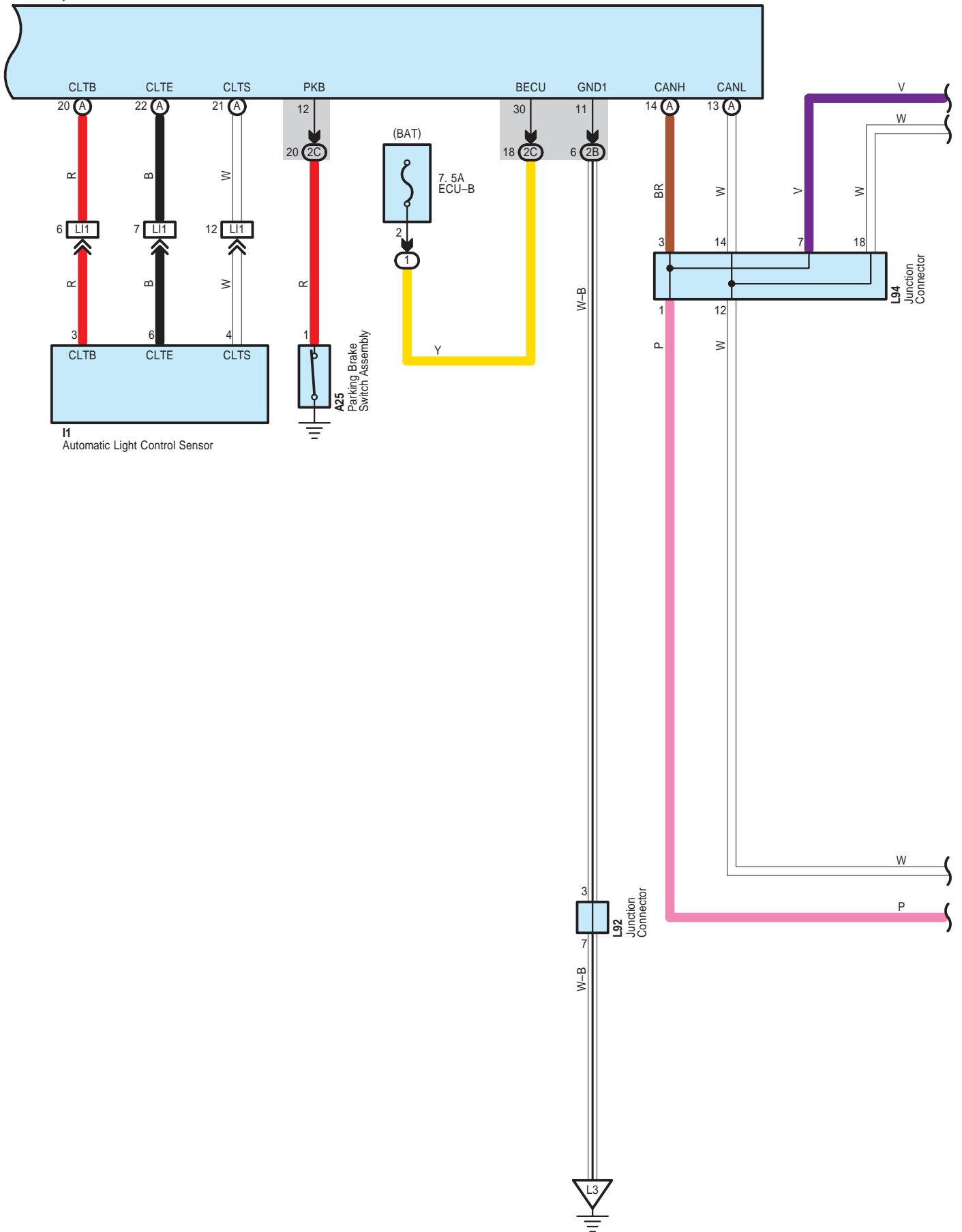

# Headlight

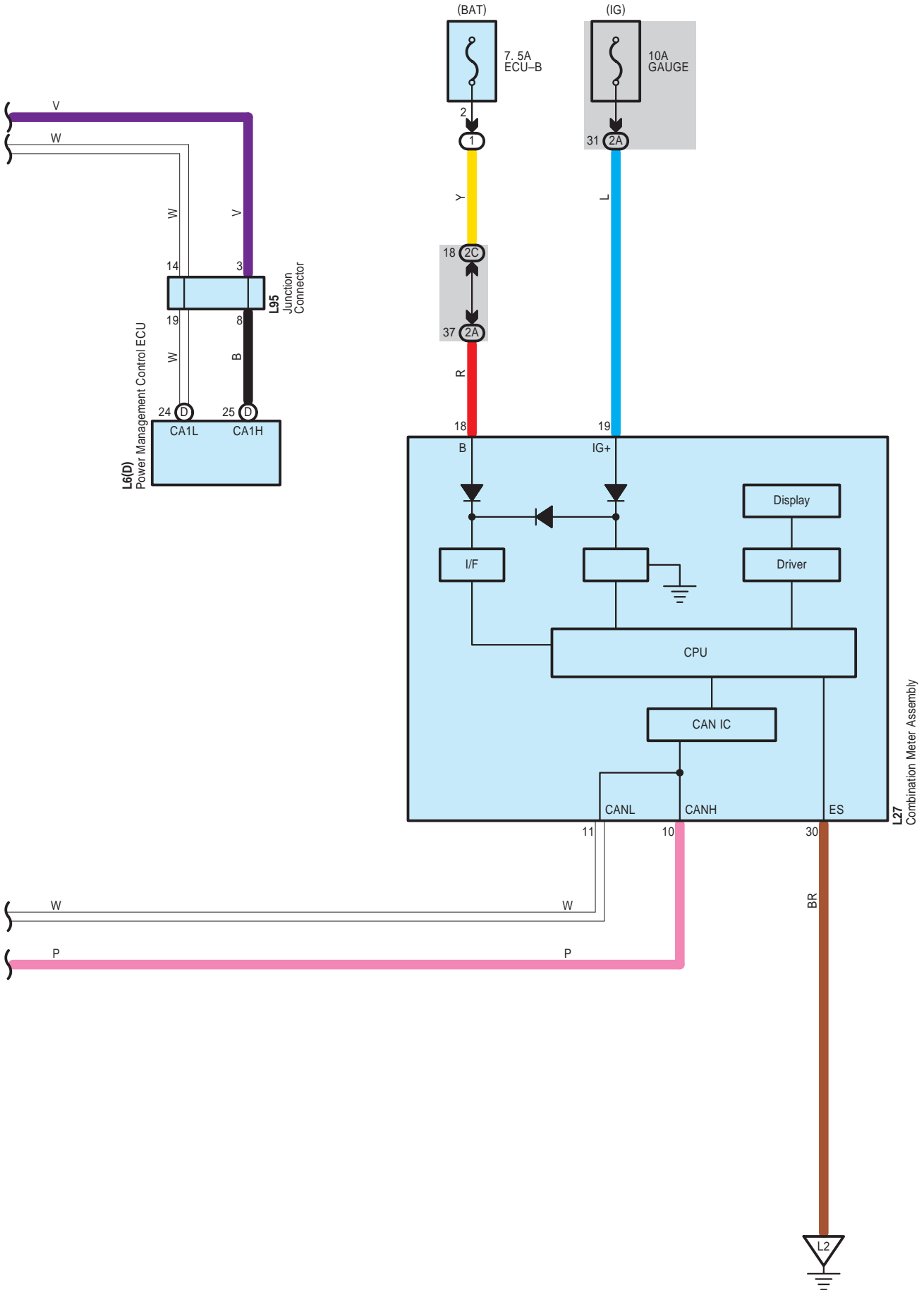

# Headlight

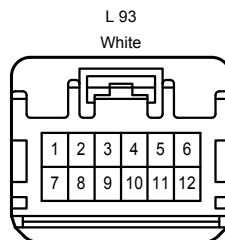
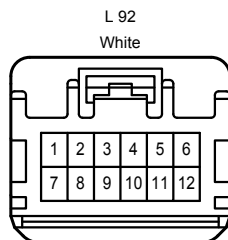
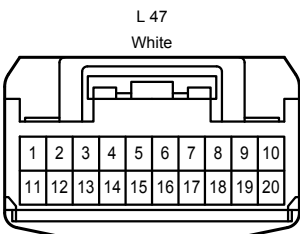
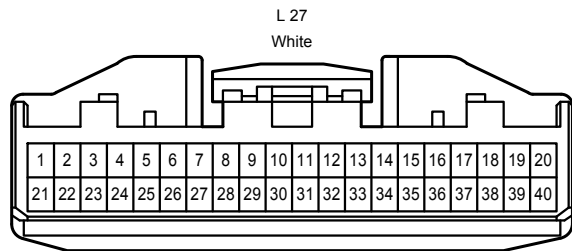
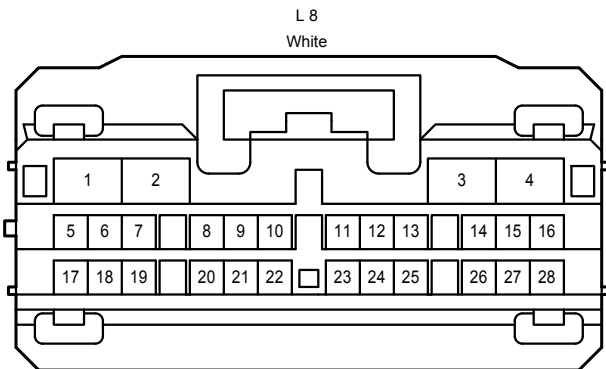
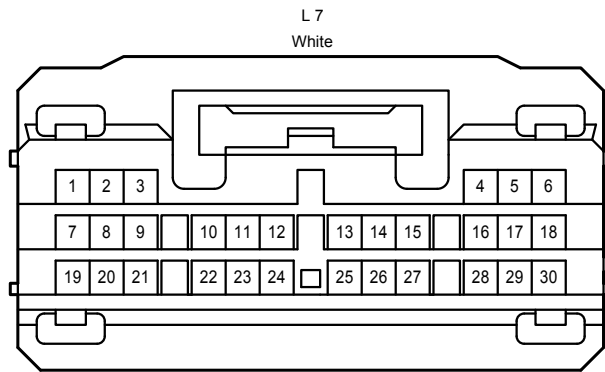
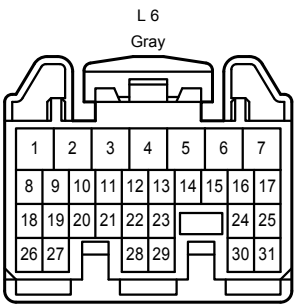
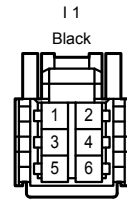
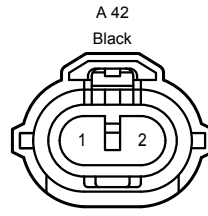
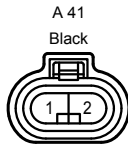
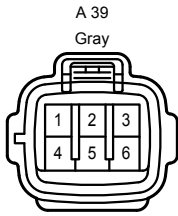
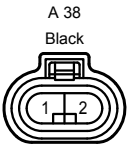
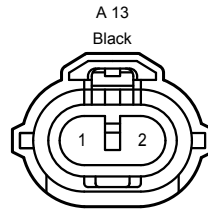
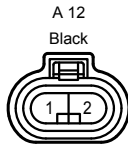
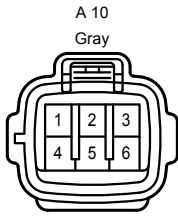
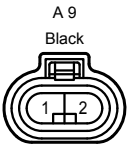

# Headlight

L 94  
White

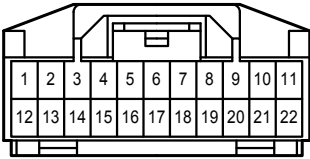

L 95  
White

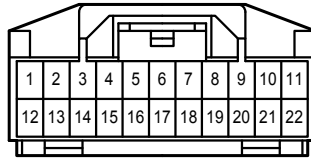

1G  
White

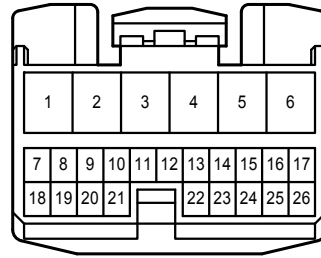

1H  
White

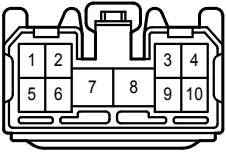

2A  
White

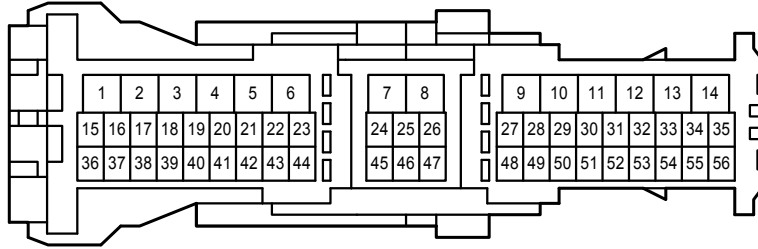

2B  
White

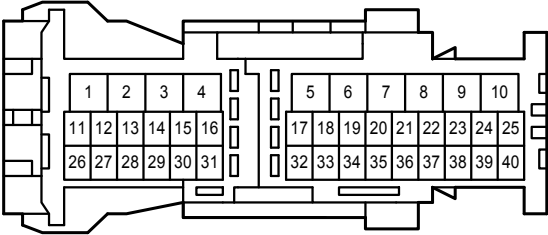

2C  
White

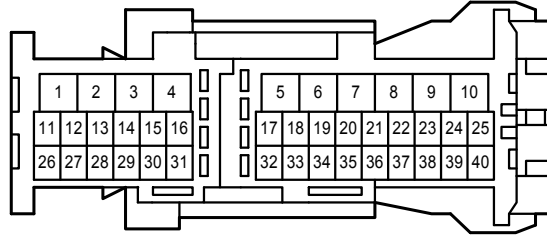

3A  
White

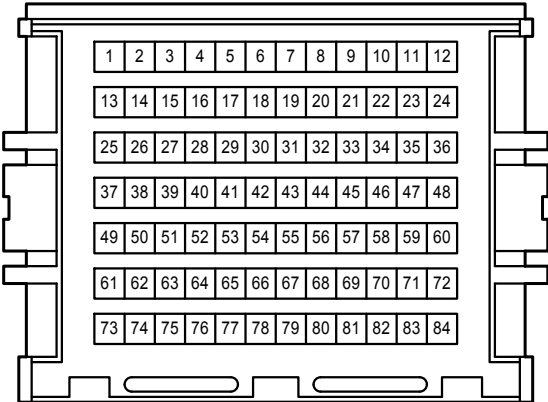

AL2  
Gray

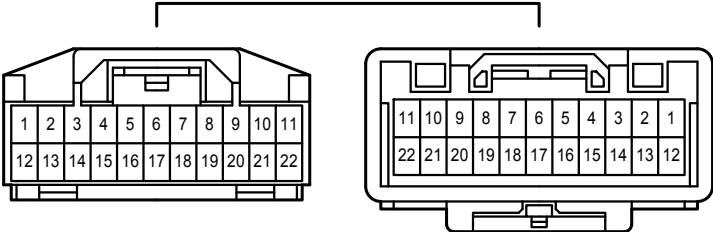



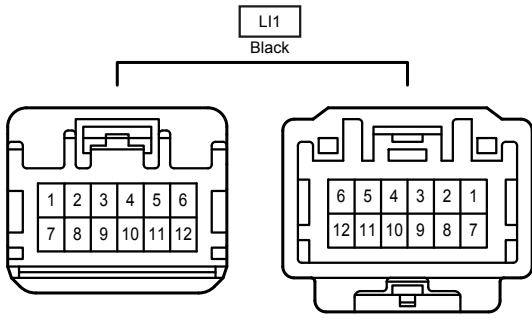

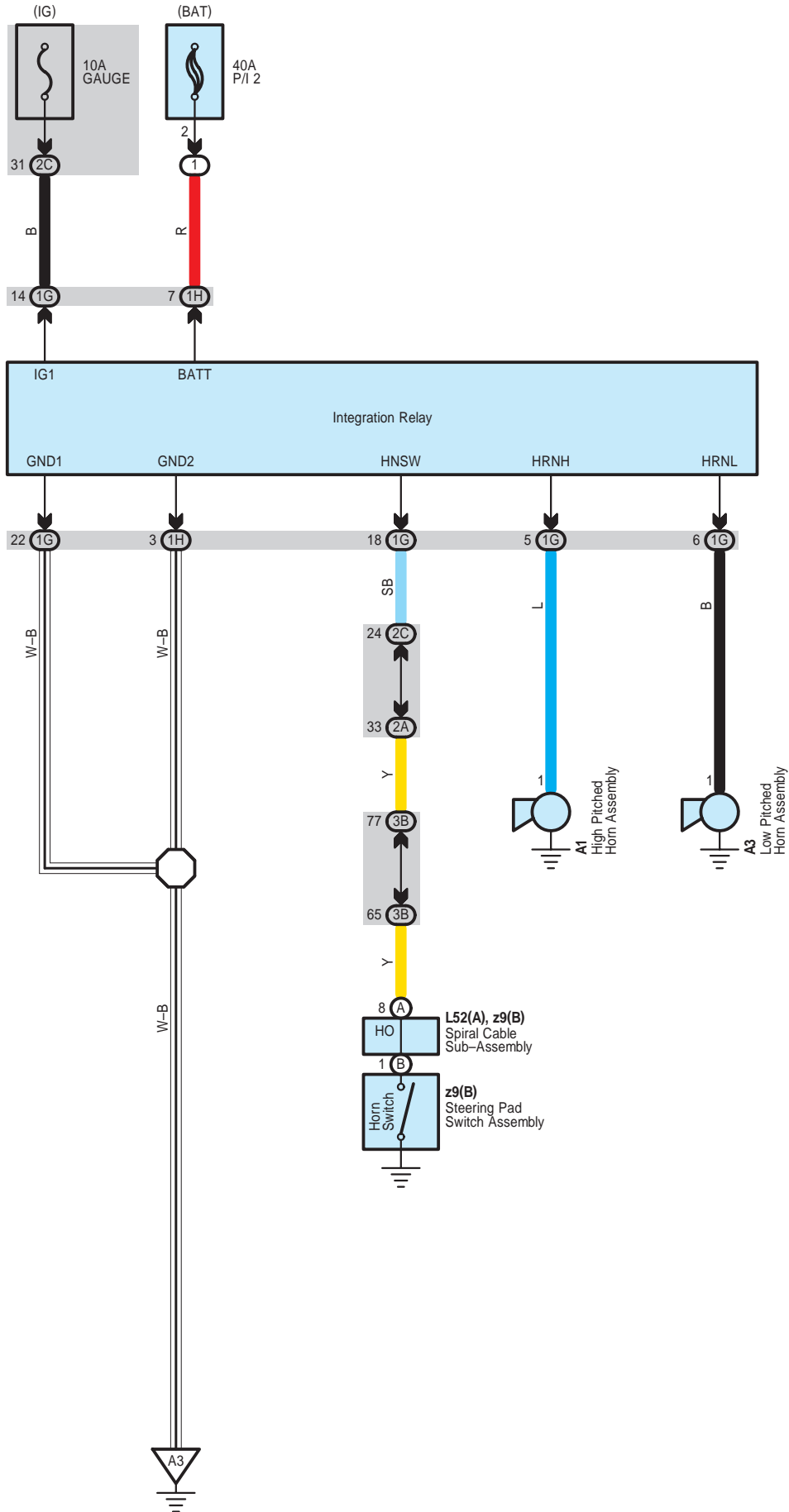

Horn

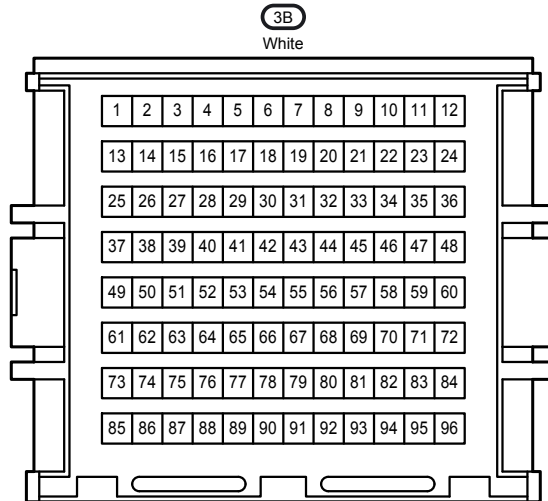
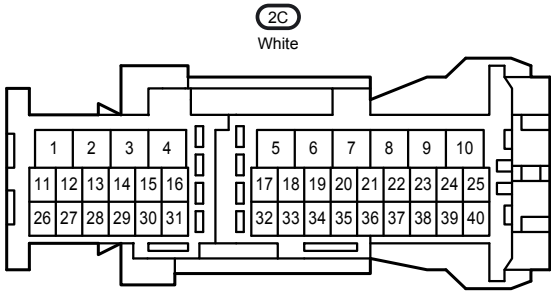
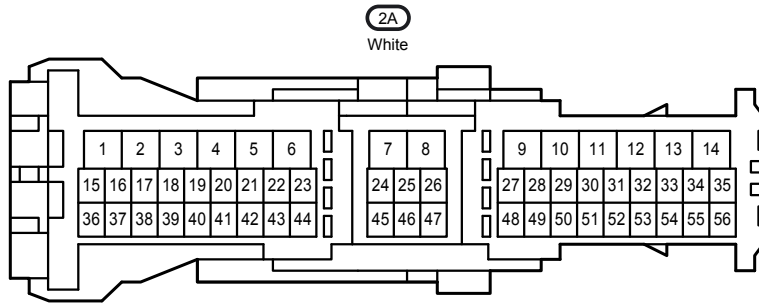
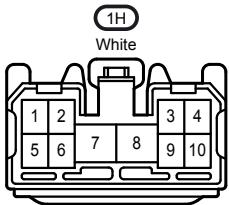
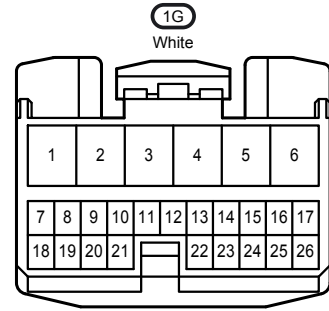
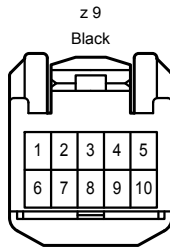
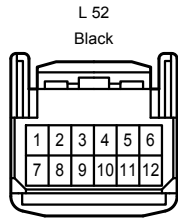
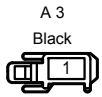
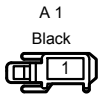

# Hybrid System , Shift Control System

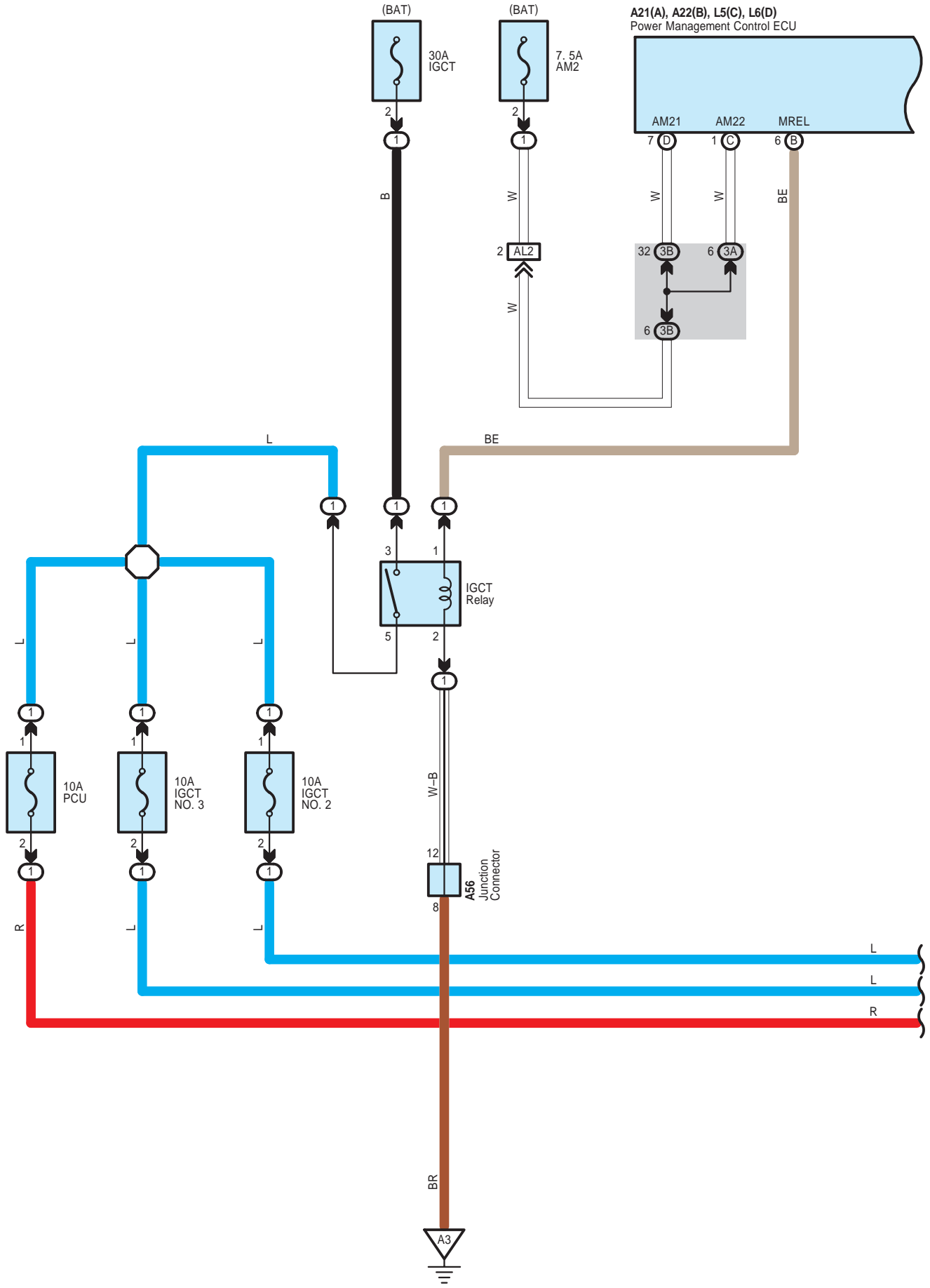

# Hybrid System , Shift Control System

A21(A), A22(B), L5(C), L6(D)  
Power Management Control ECU

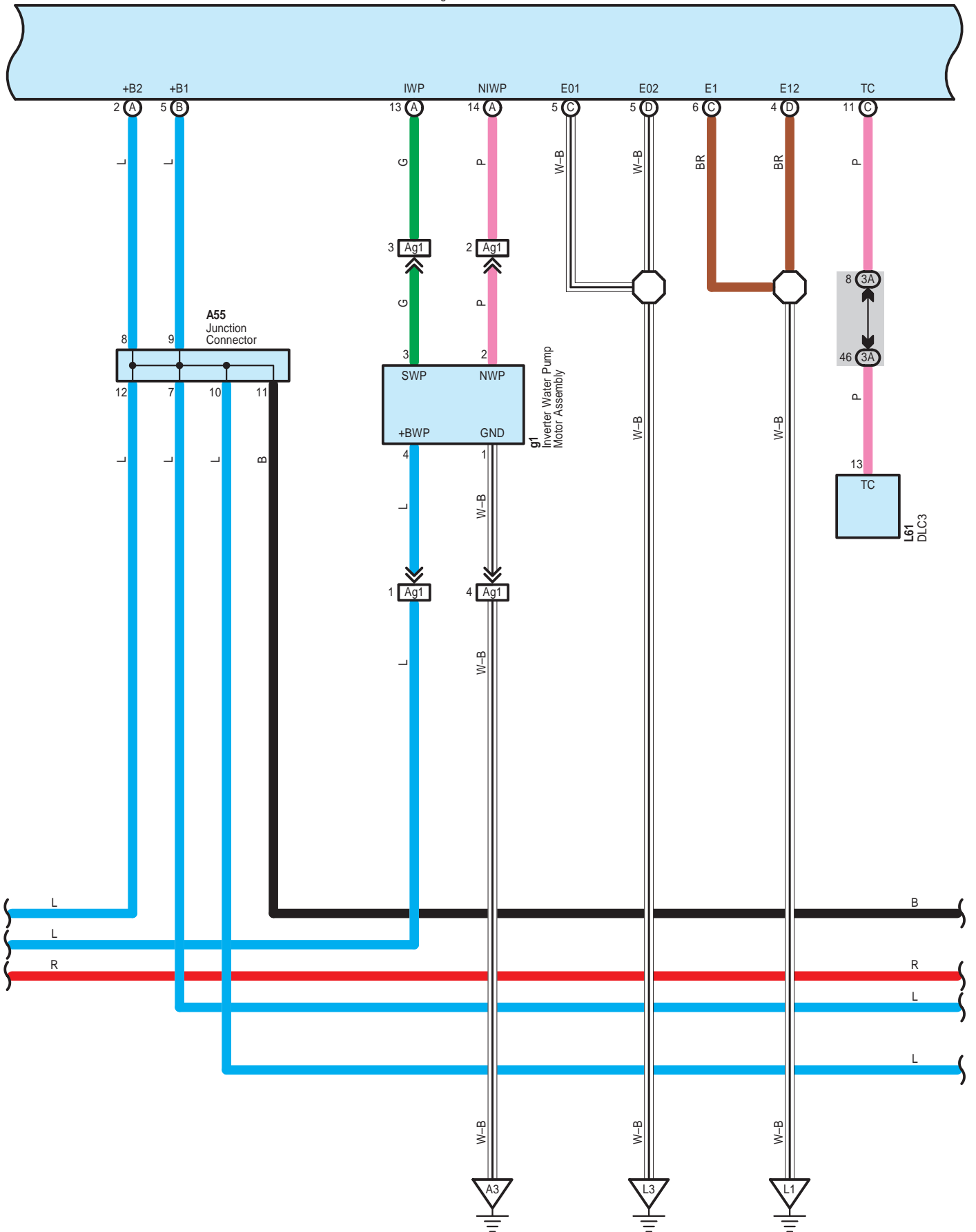

Hybrid System , Shift Control System

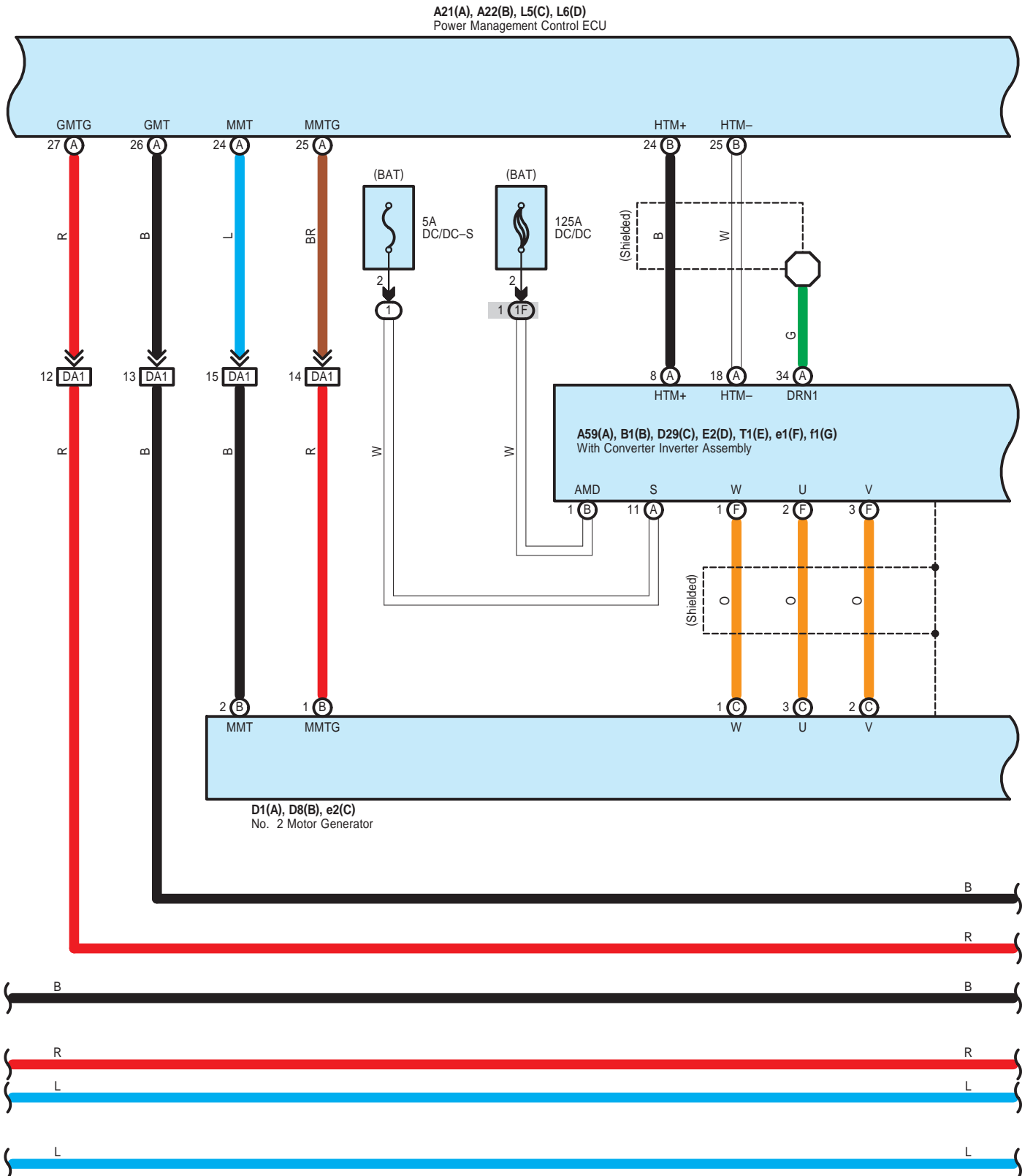

Hybrid System , Shift Control System

A21(A), A22(B), L5(C), L6(D)  
Power Management Control ECU

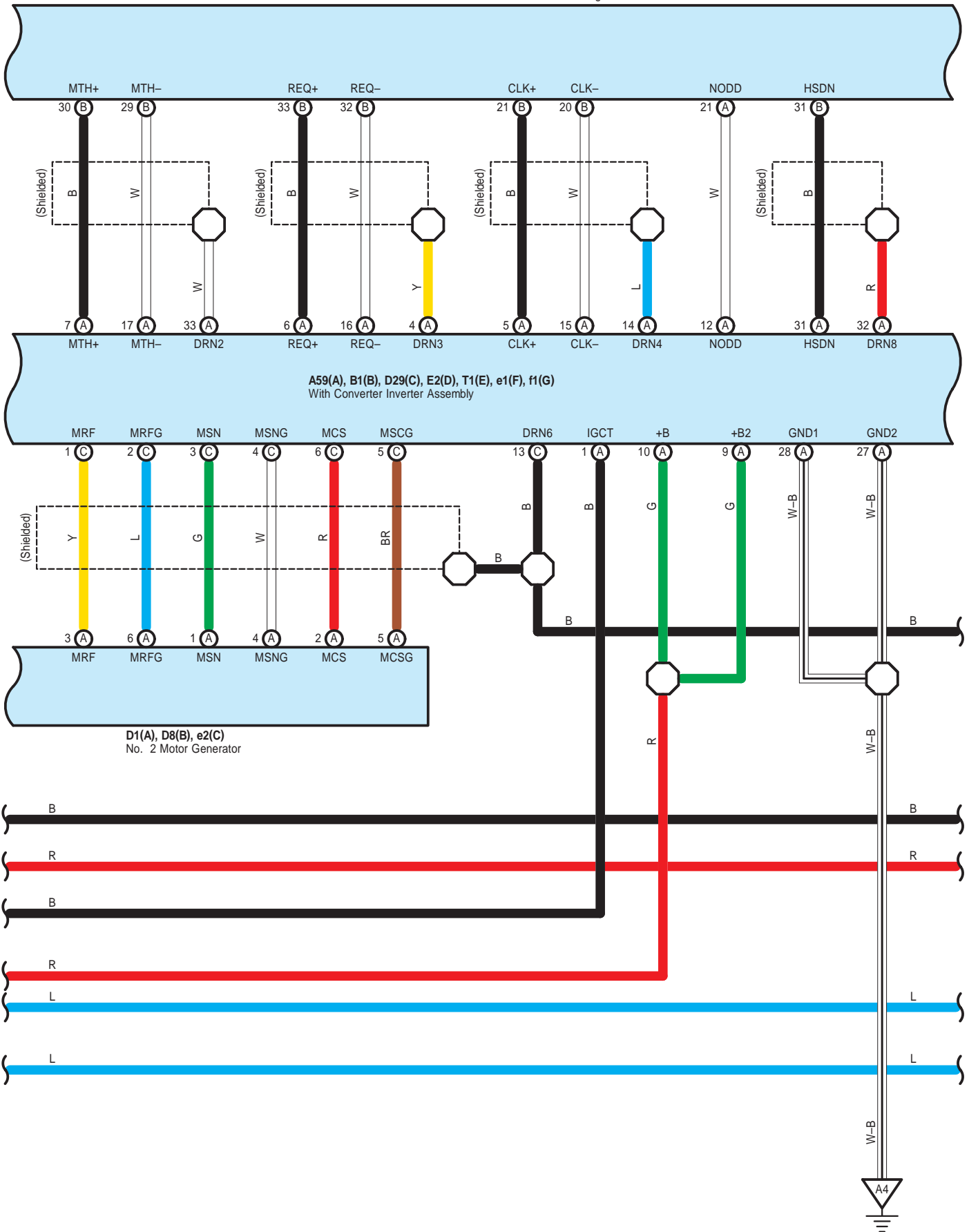

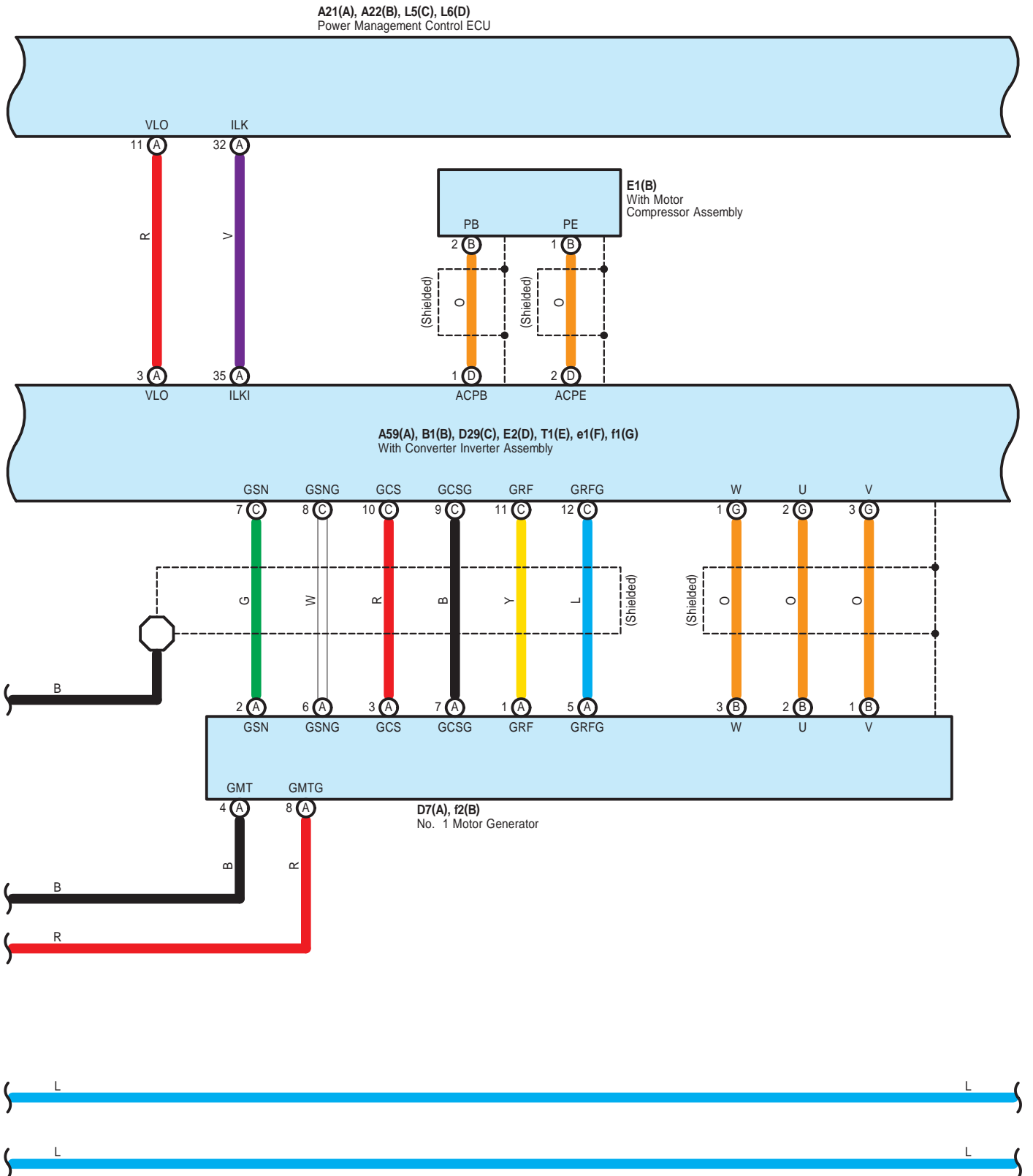



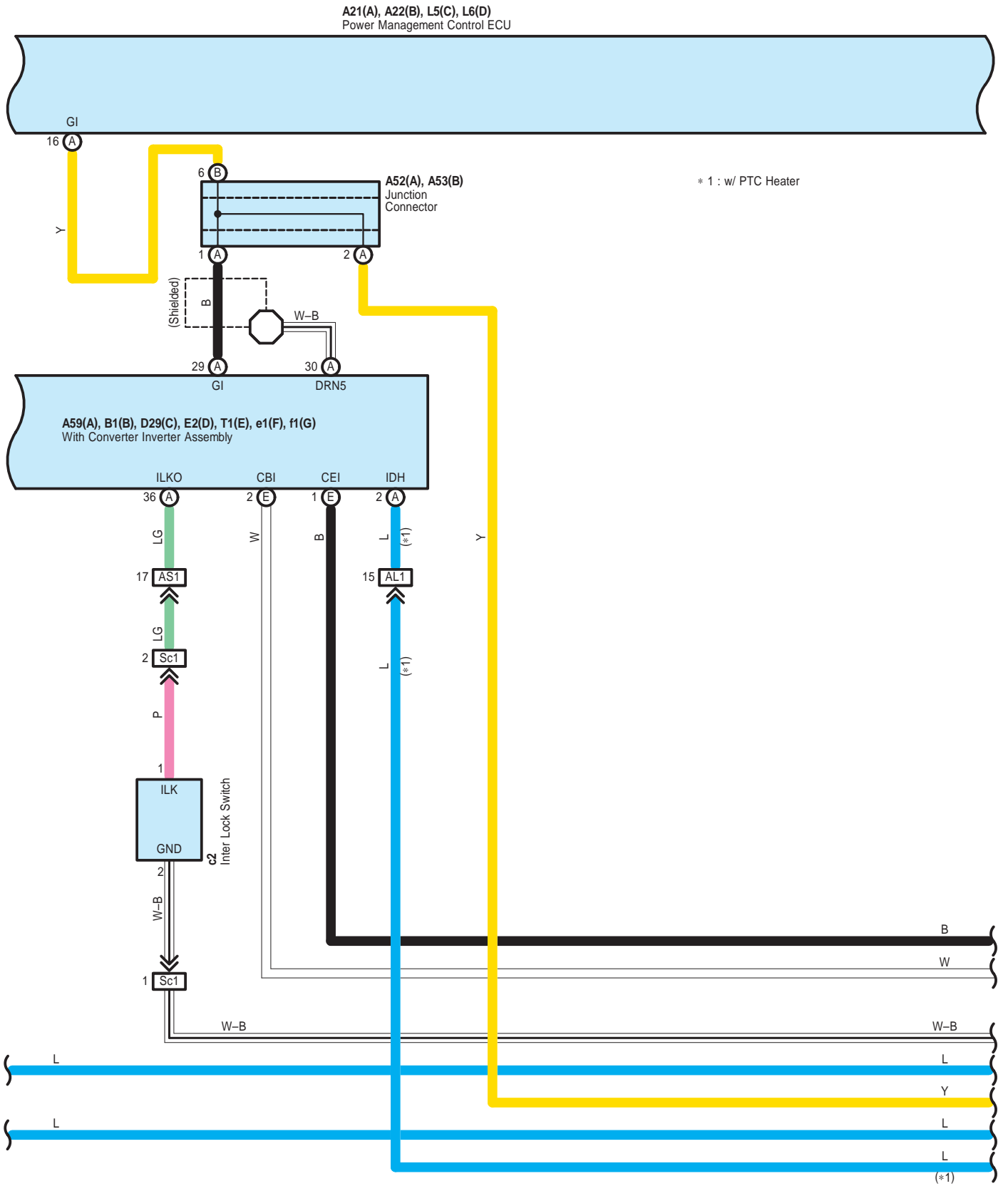





Hybrid System , Shift Control System

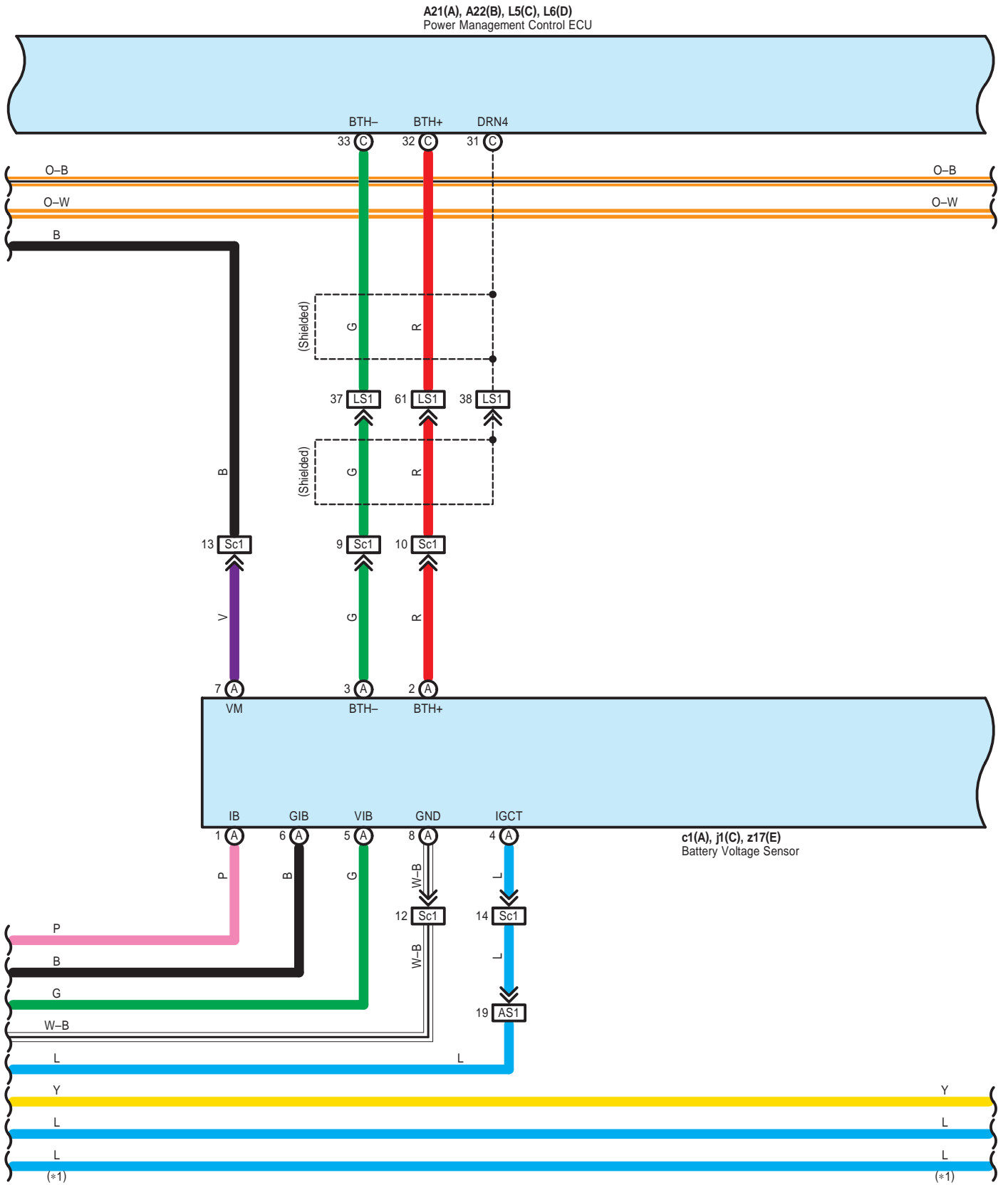

# Hybrid System , Shift Control System

\* 1 : w/ PTC Heater

A21(A), A22(B), L5(C), L6(D)  
Power Management Control ECU

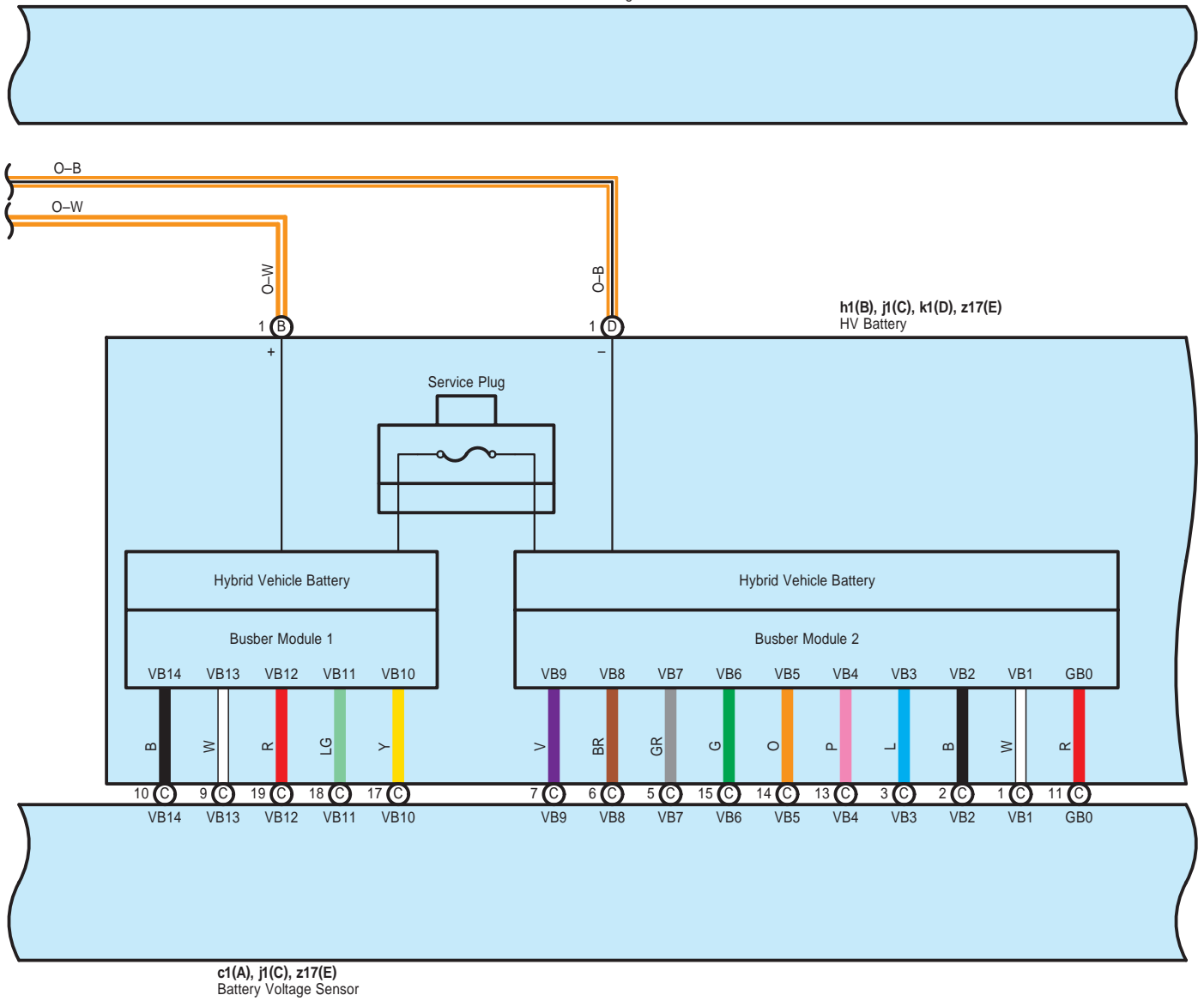

A21(A), A22(B), L5(C), L6(D)  
Power Management Control ECU

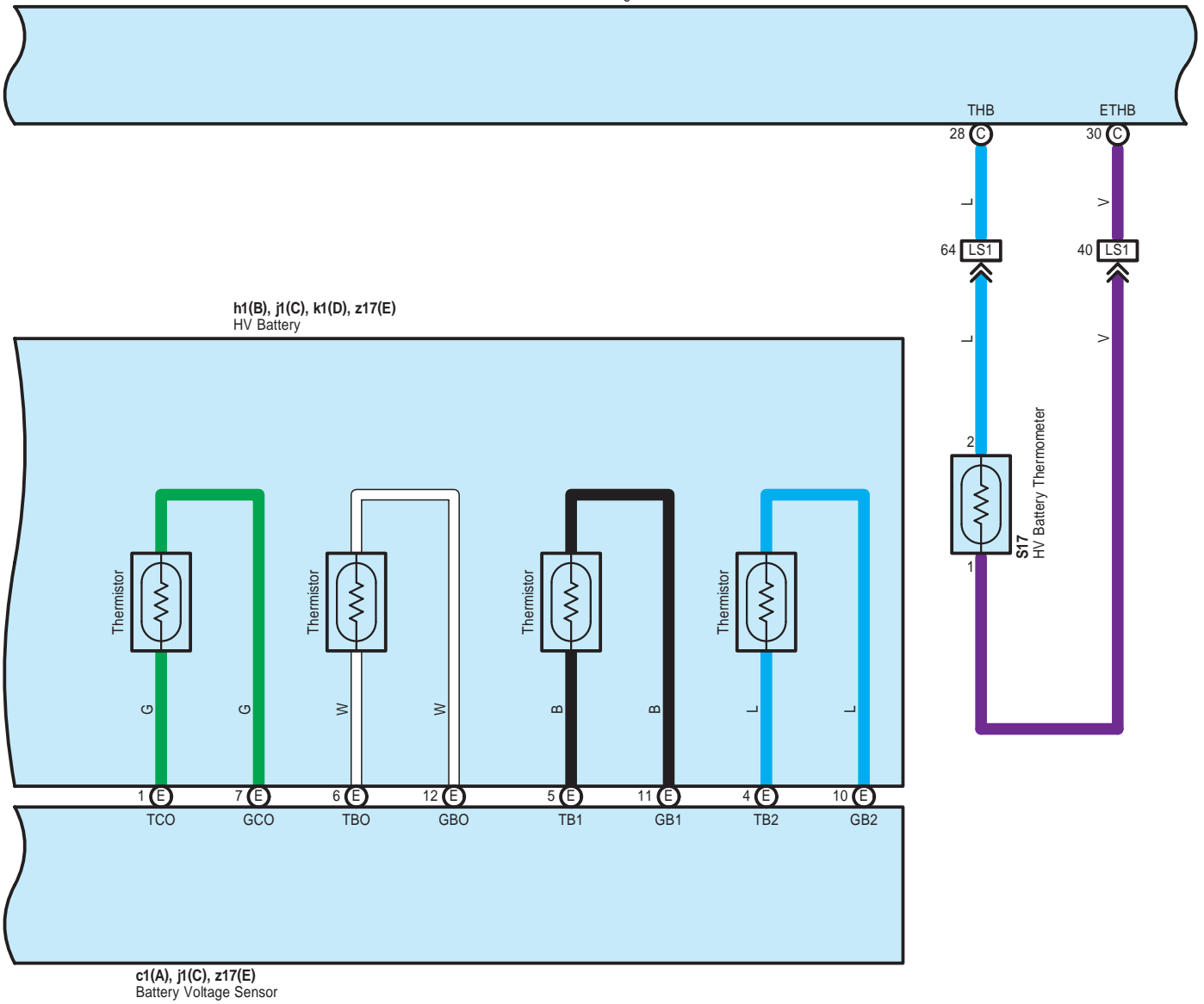

A21(A), A22(B), L5(C), L6(D)  
Power Management Control ECU

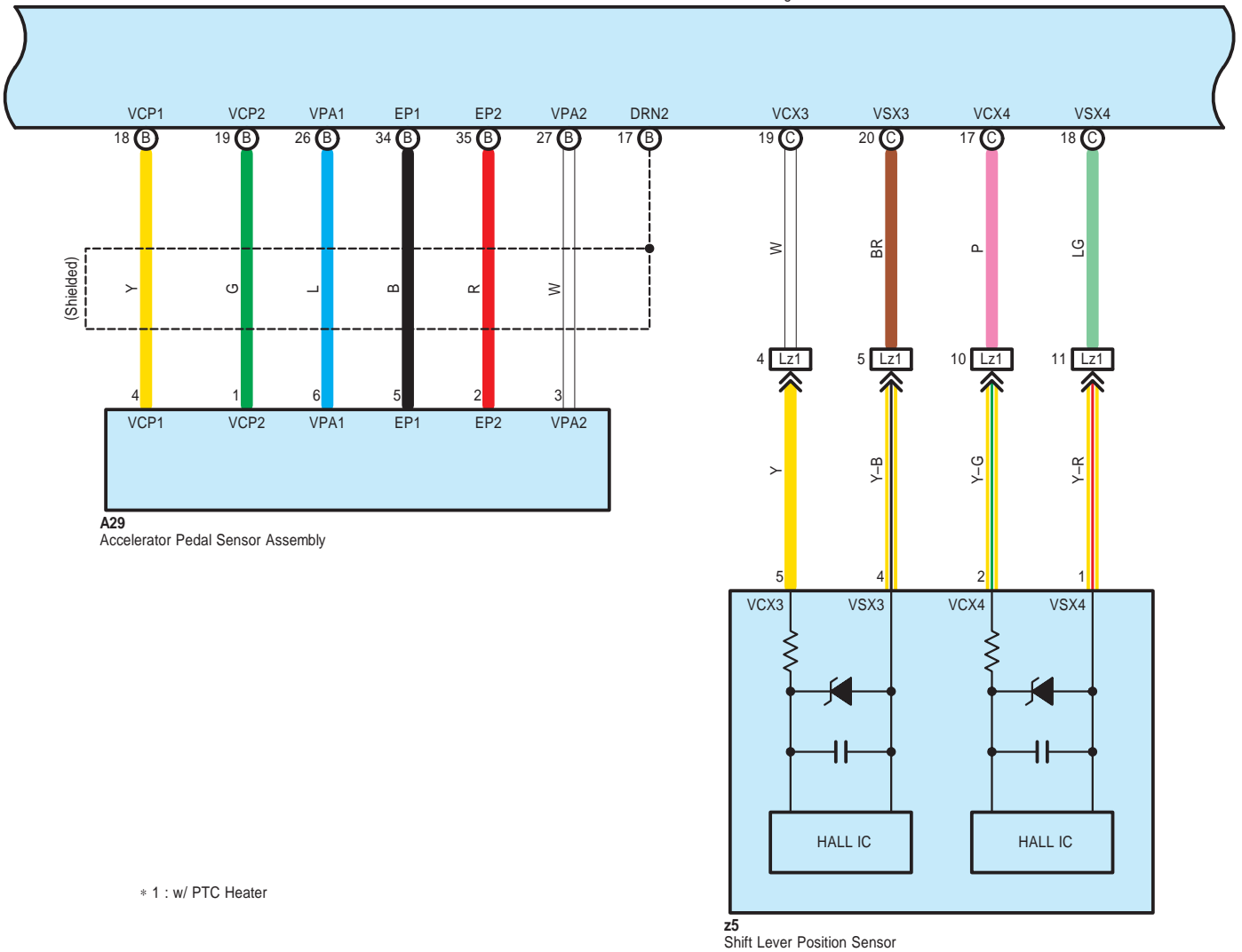

A21(A), A22(B), L5(C), L6(D)  
Power Management Control ECU

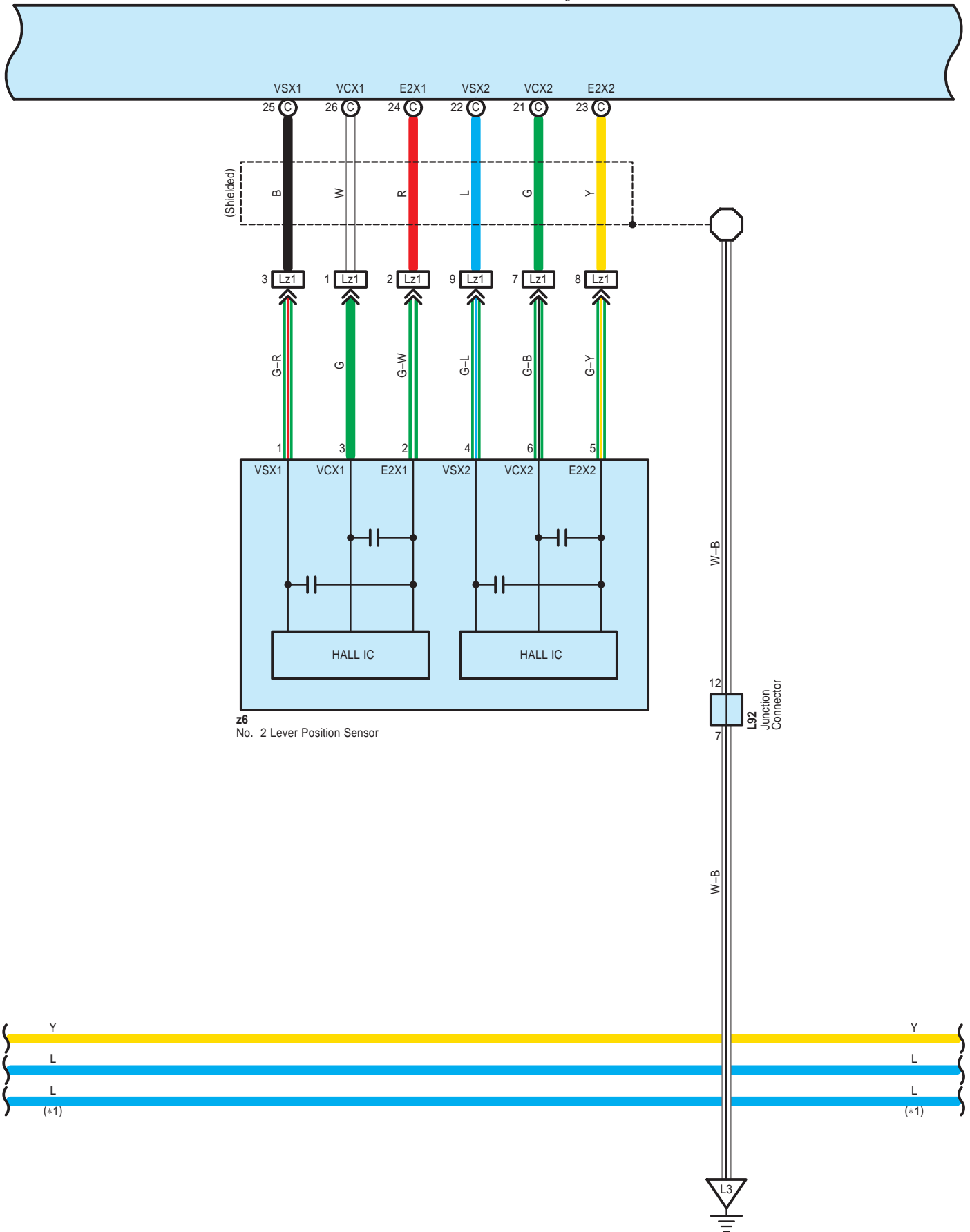



# Hybrid System , Shift Control System

A21(A), A22(B), L5(C), L6(D)  
Power Management Control ECU

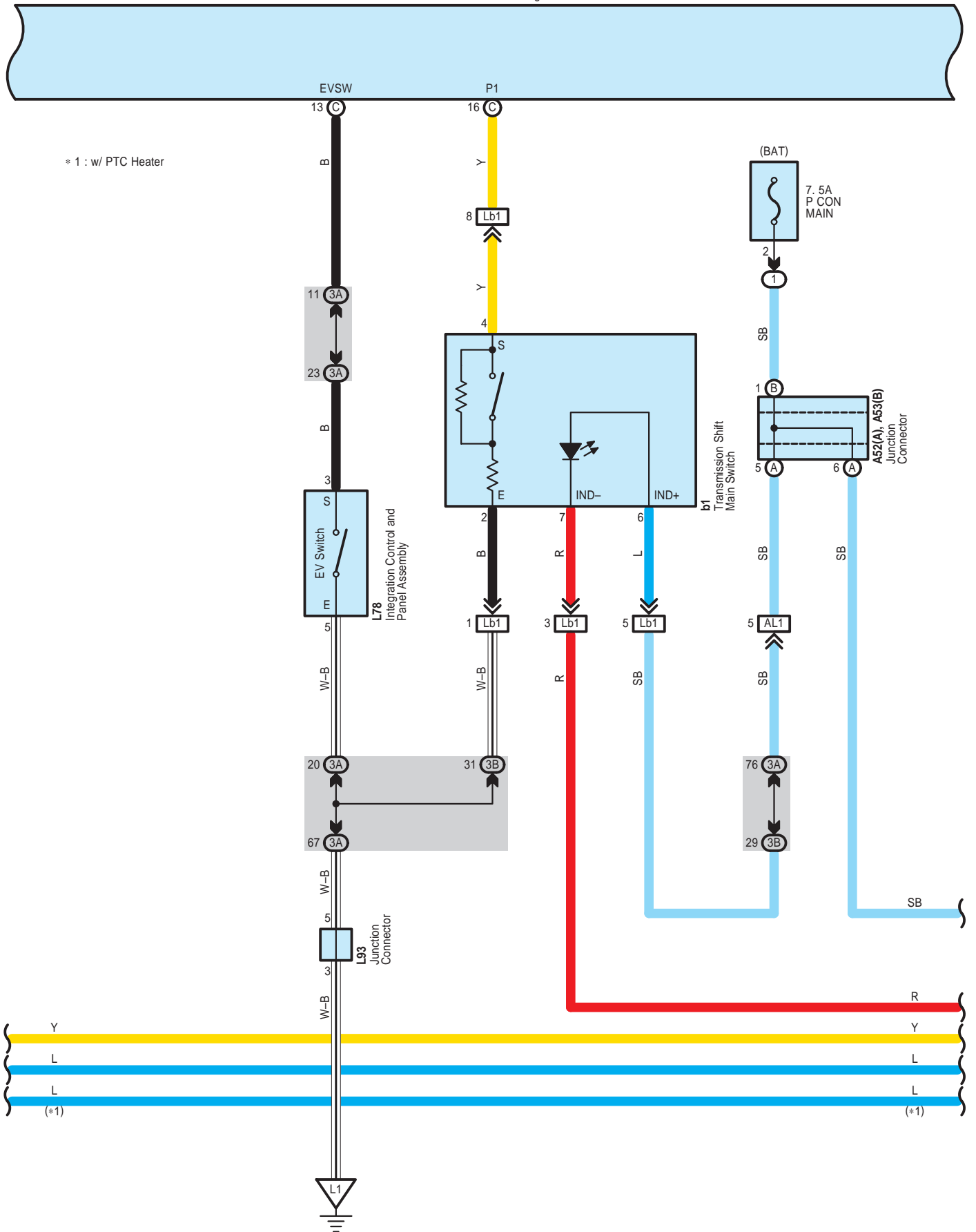

\* 1 : w/ PTC Heater

Hybrid System , Shift Control System

A21(A), A22(B), L5(C), L6(D)  
Power Management Control ECU

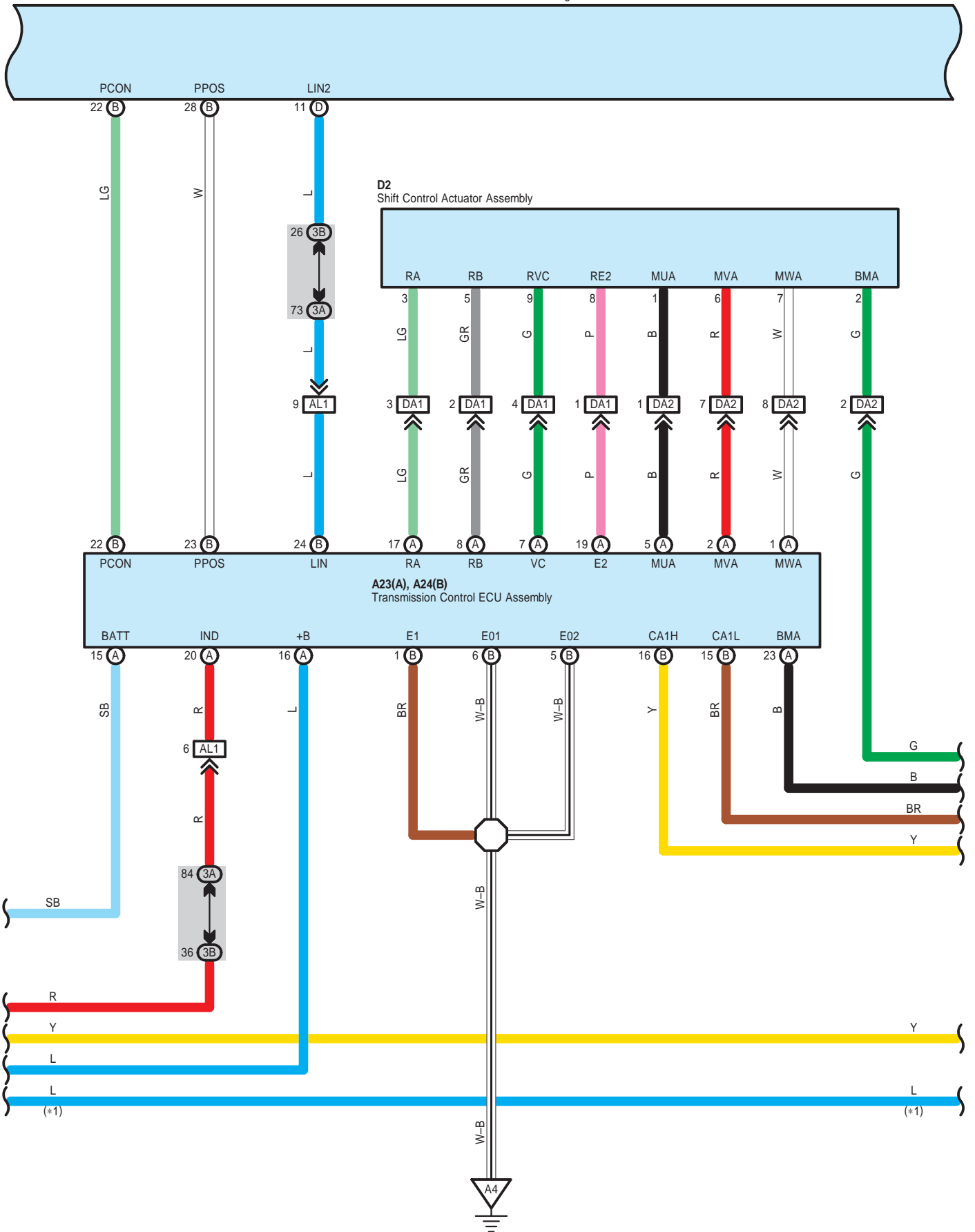

A21(A), A22(B), L5(C), L6(D)  
Power Management Control ECU

\* 1 : w/ PTC Heater

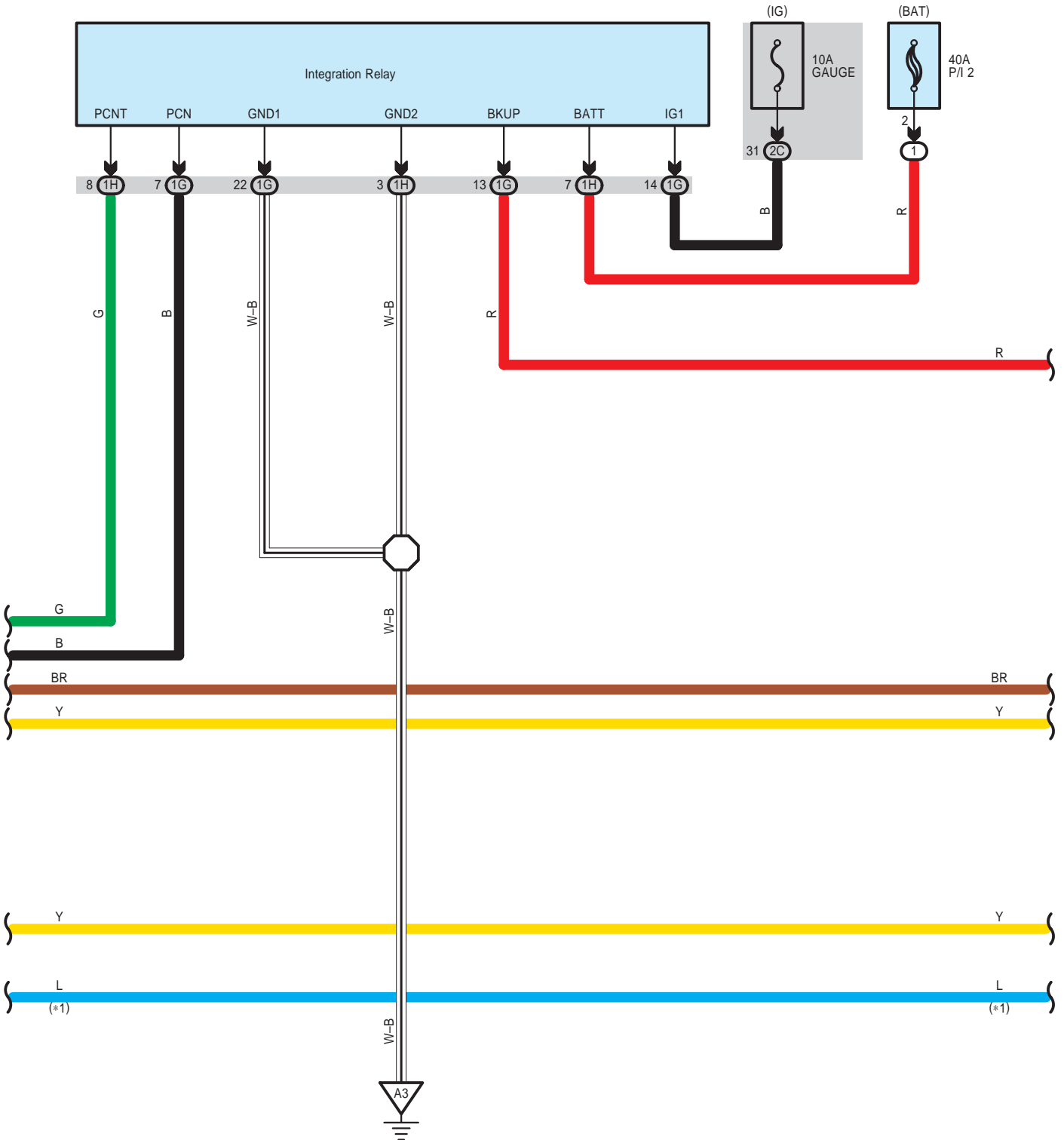

A21(A), A22(B), L5(C), L6(D)  
Power Management Control ECU

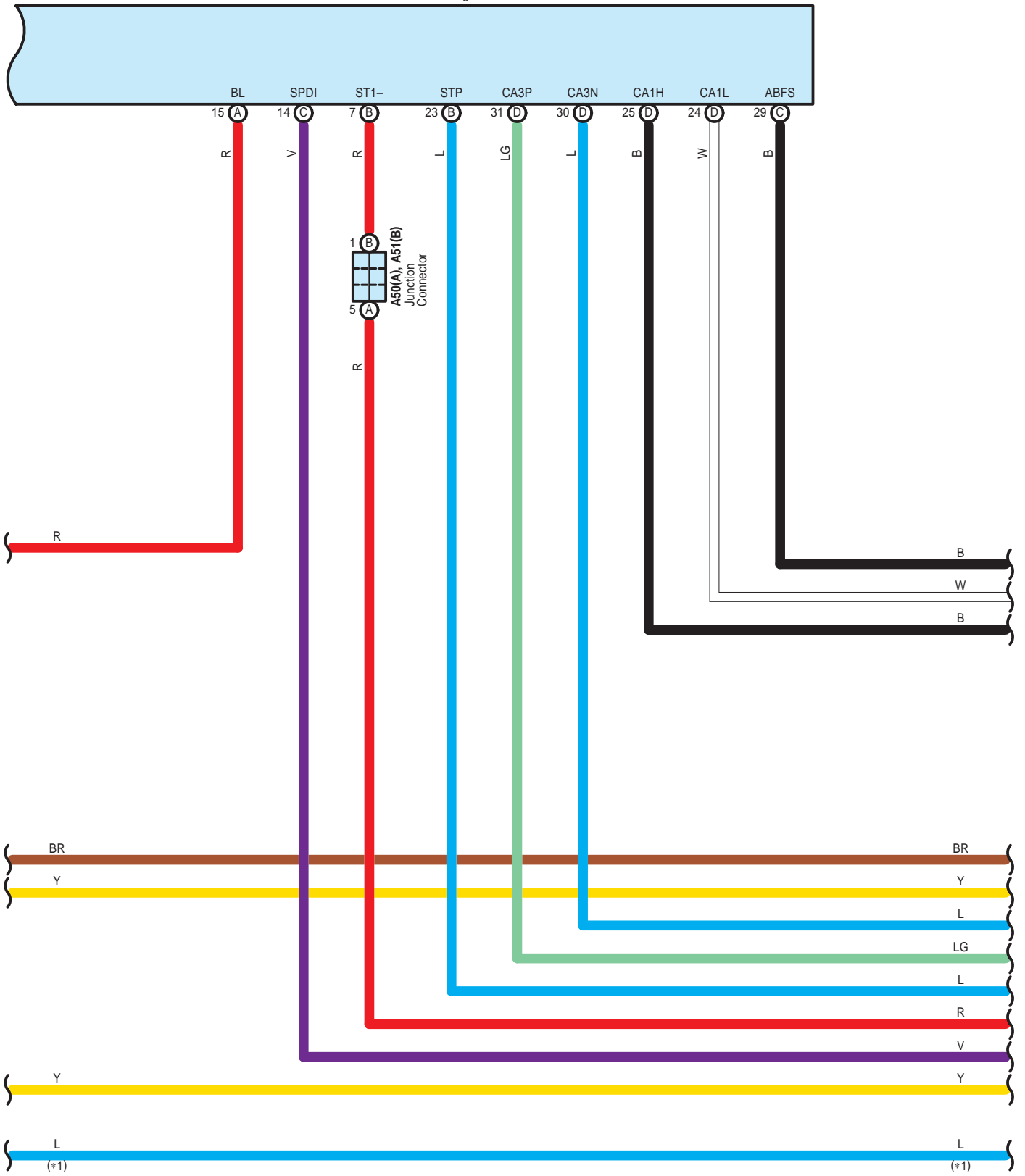

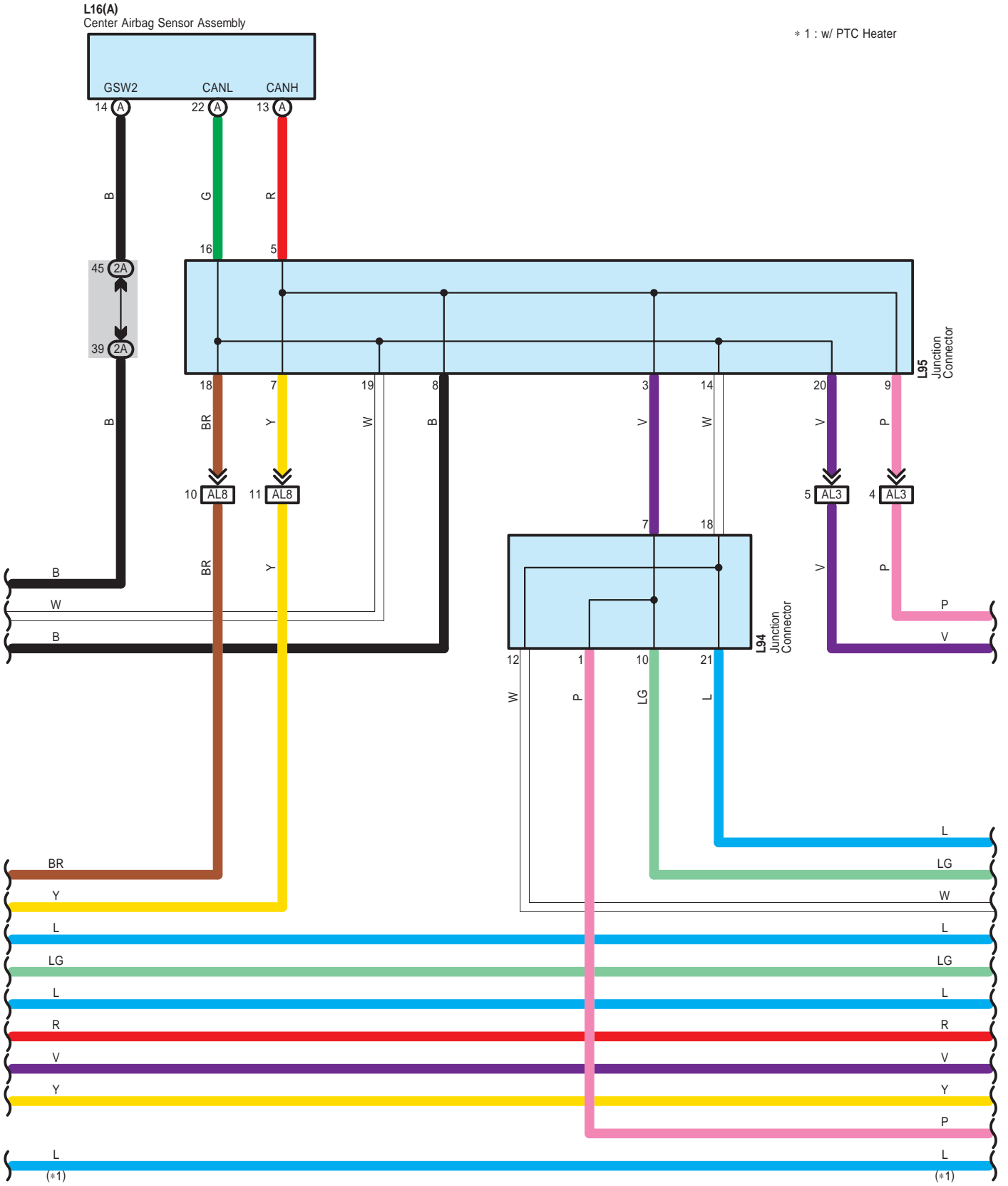

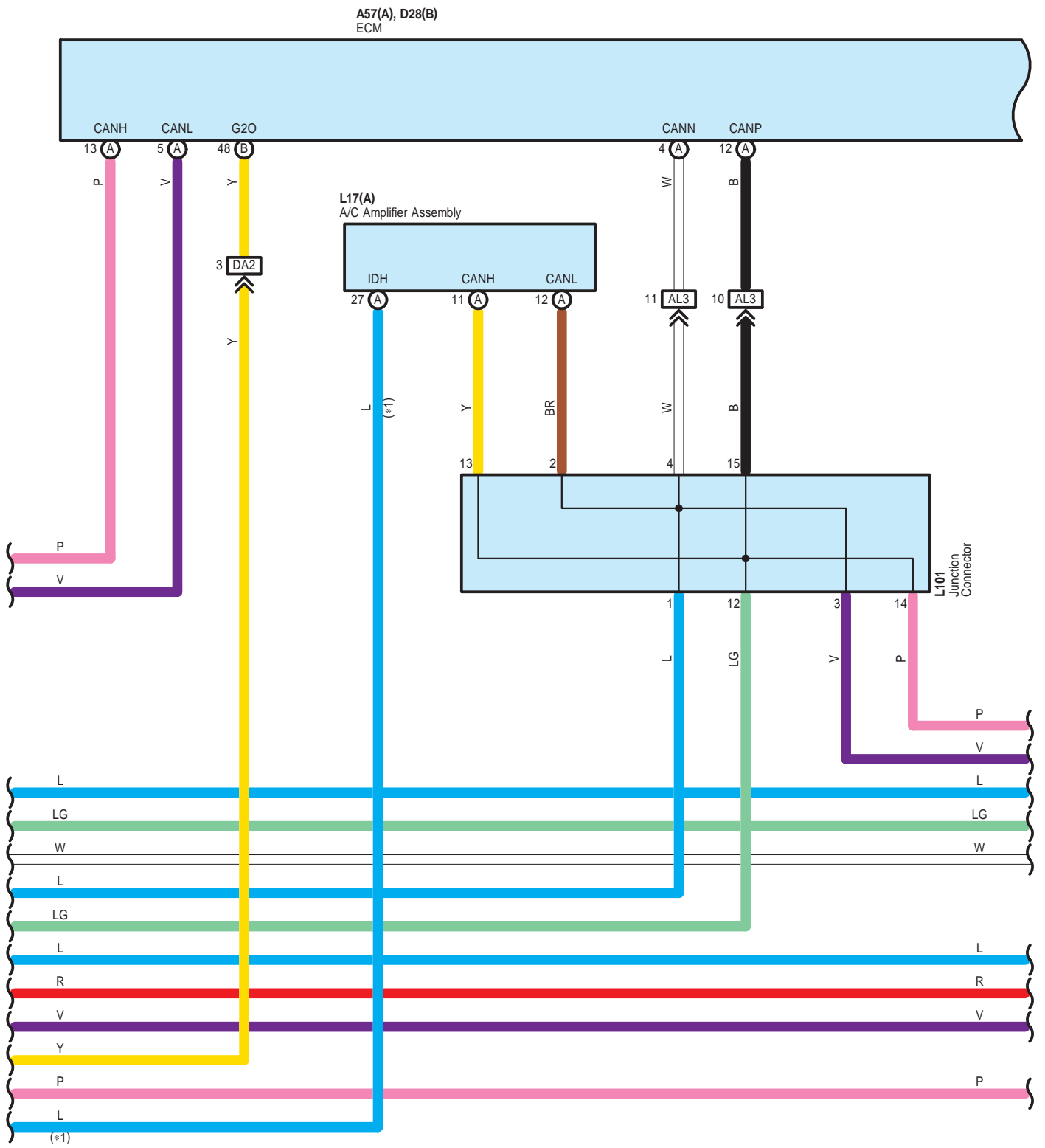

\* 1 : w/ PTC Heater

A57(A), D28(B)  
ECM

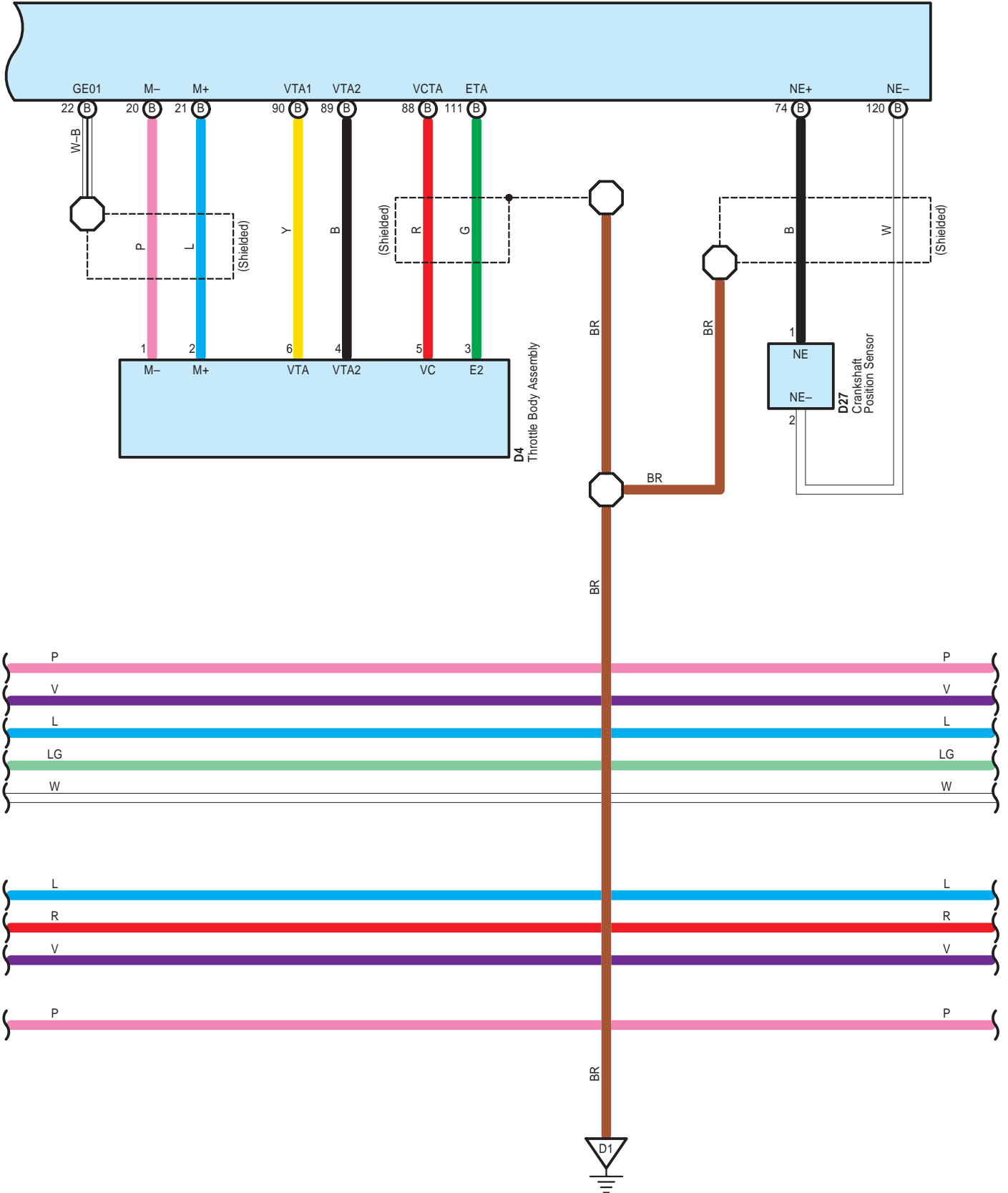

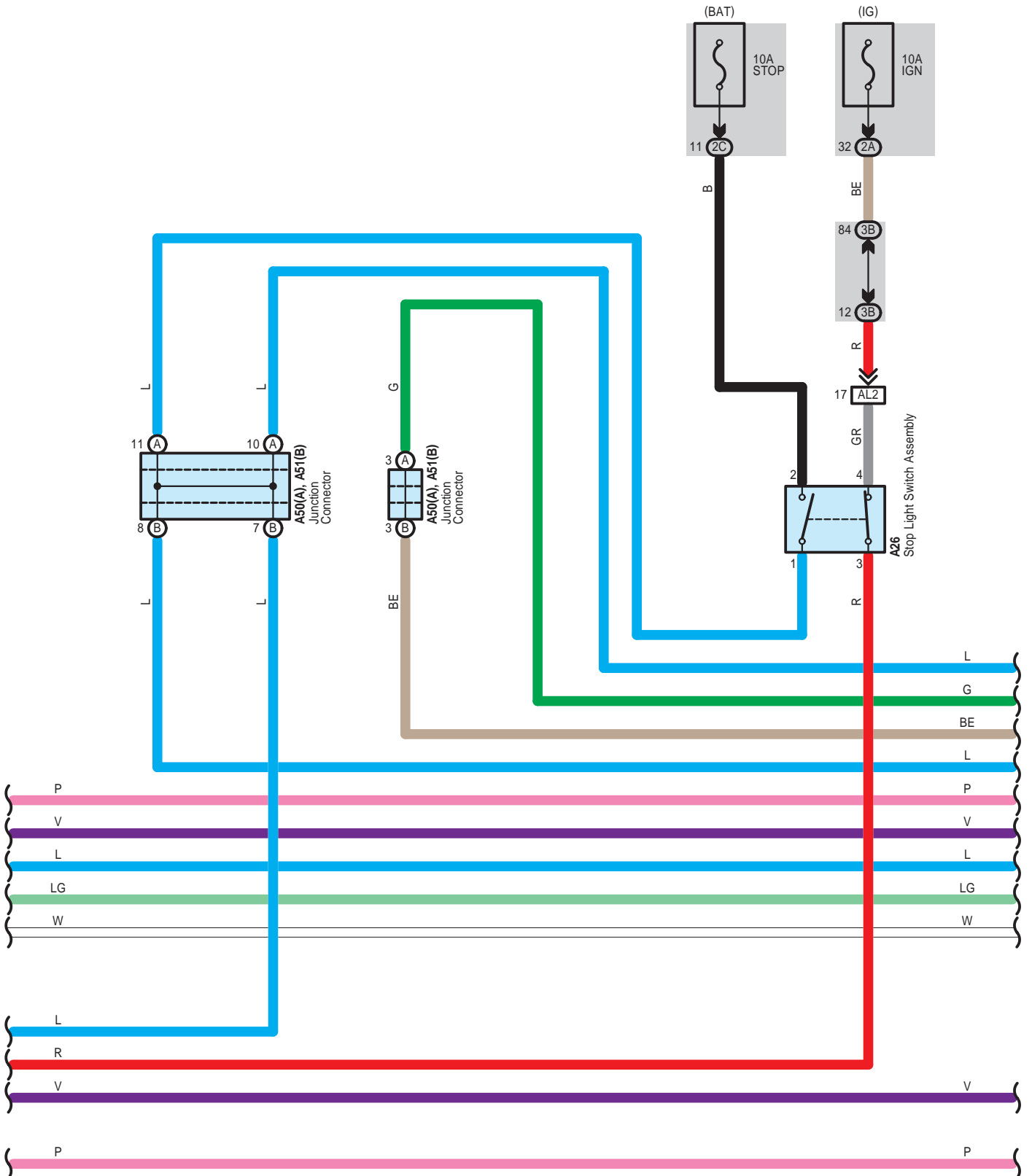



Hybrid System , Shift Control System

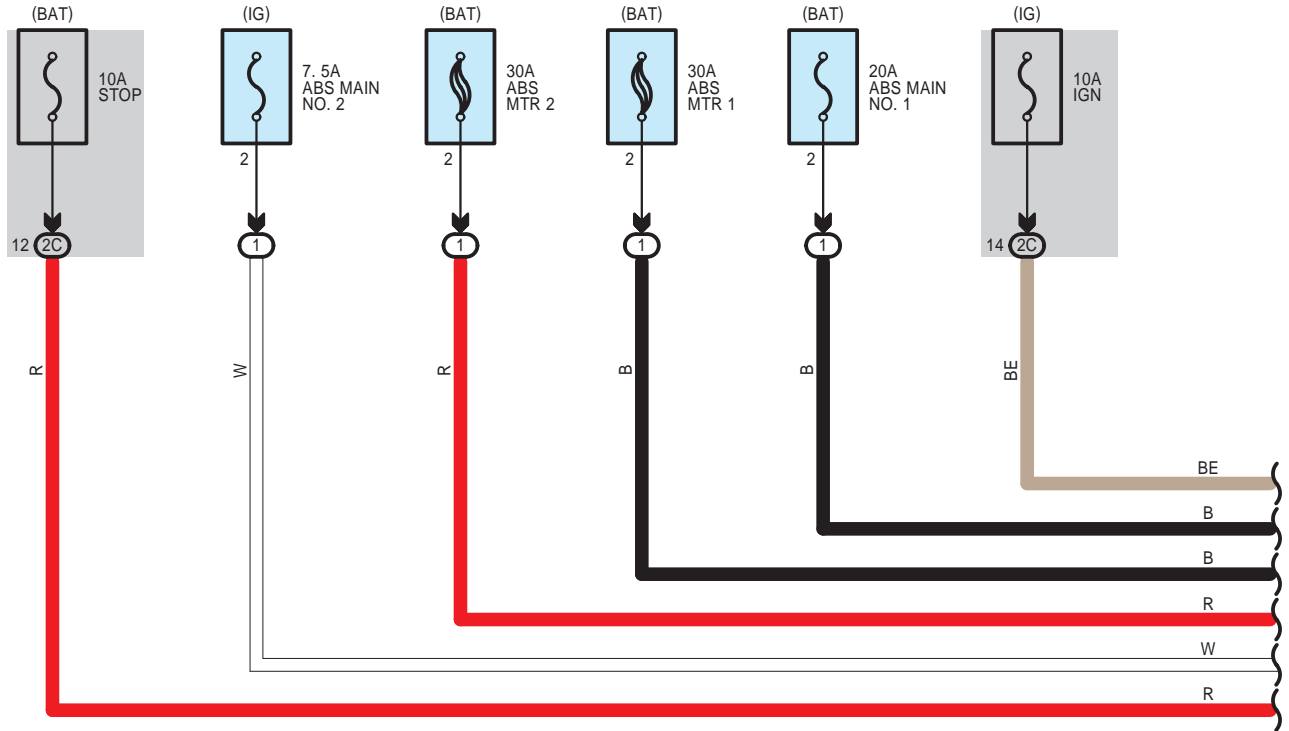

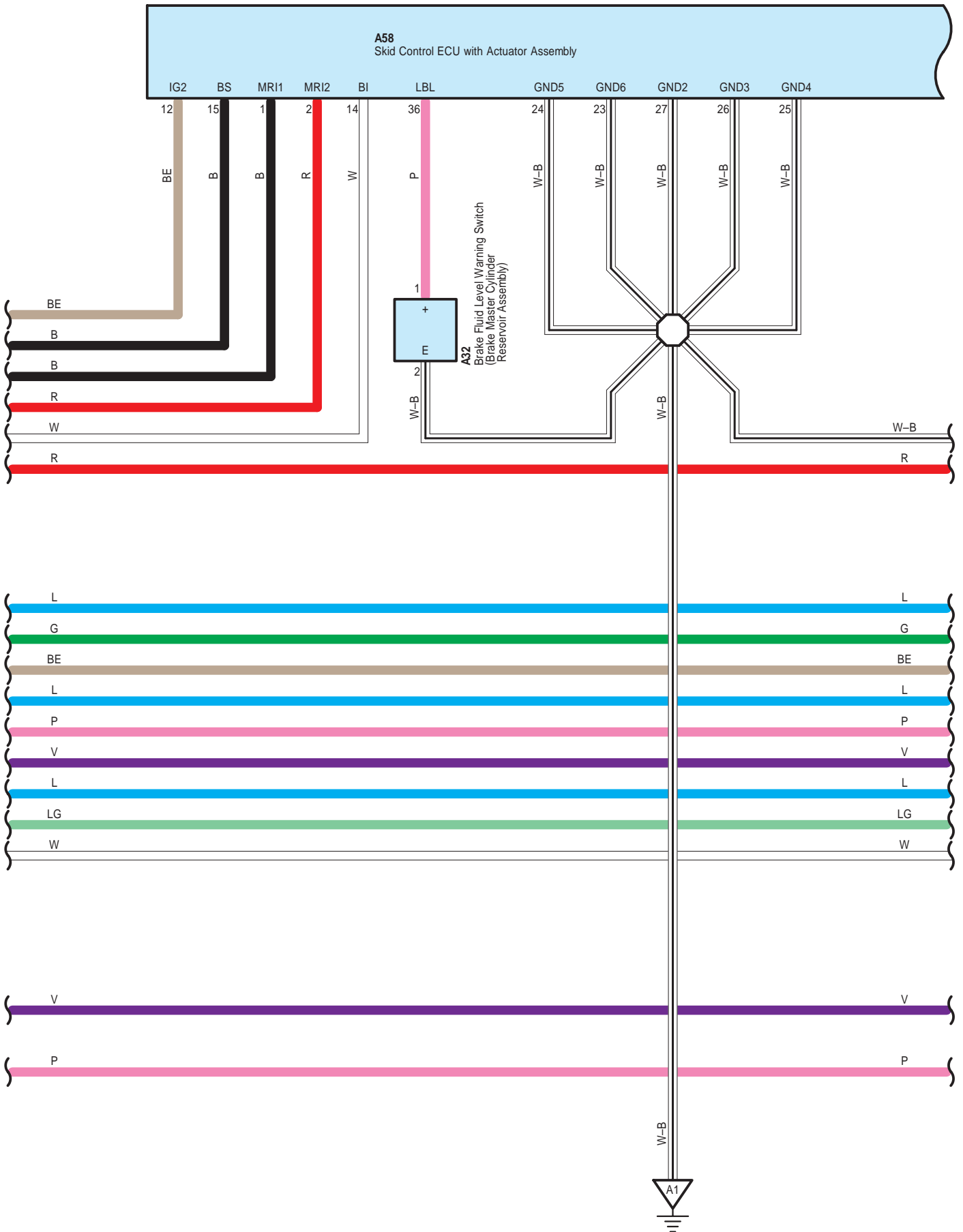

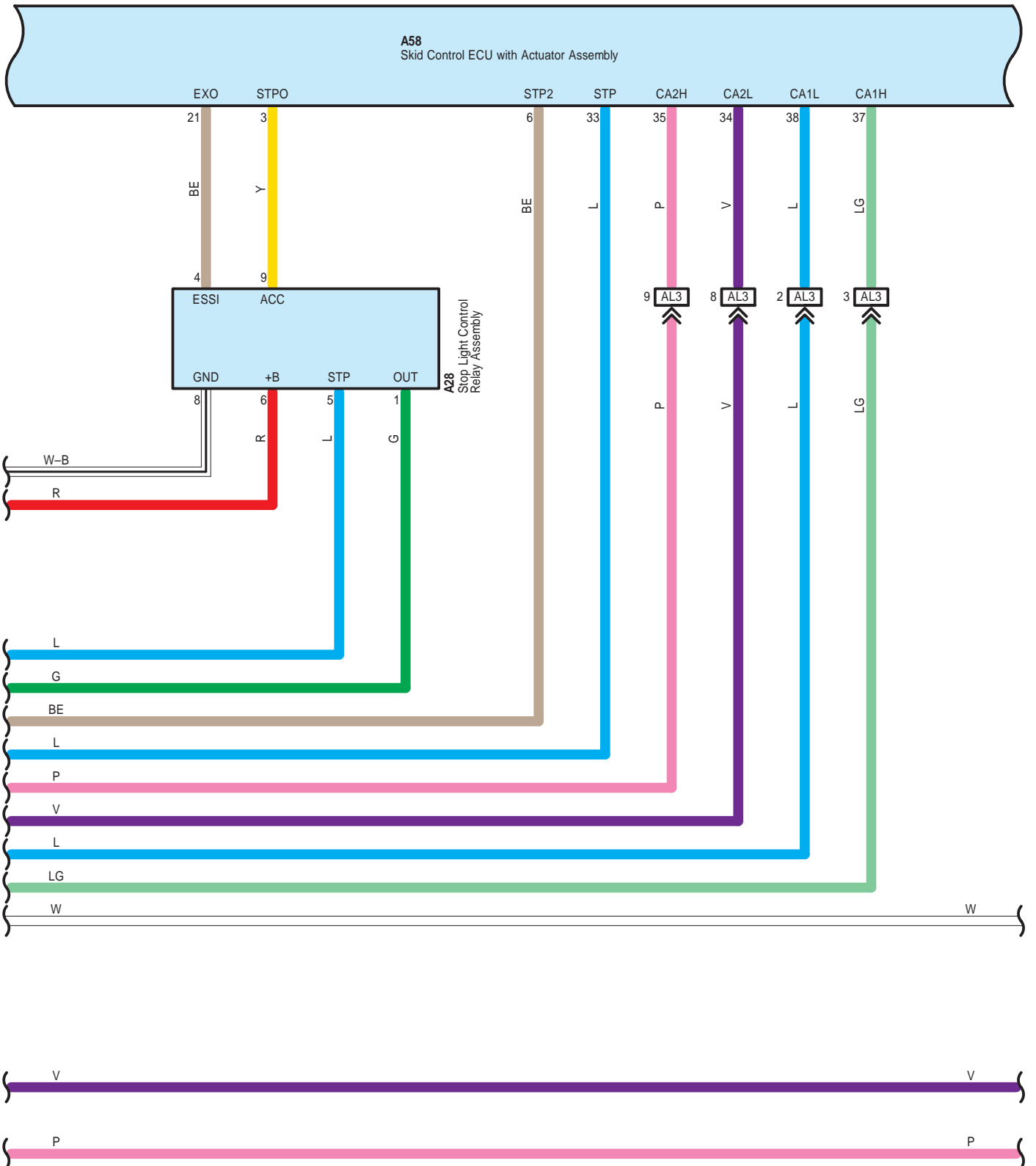

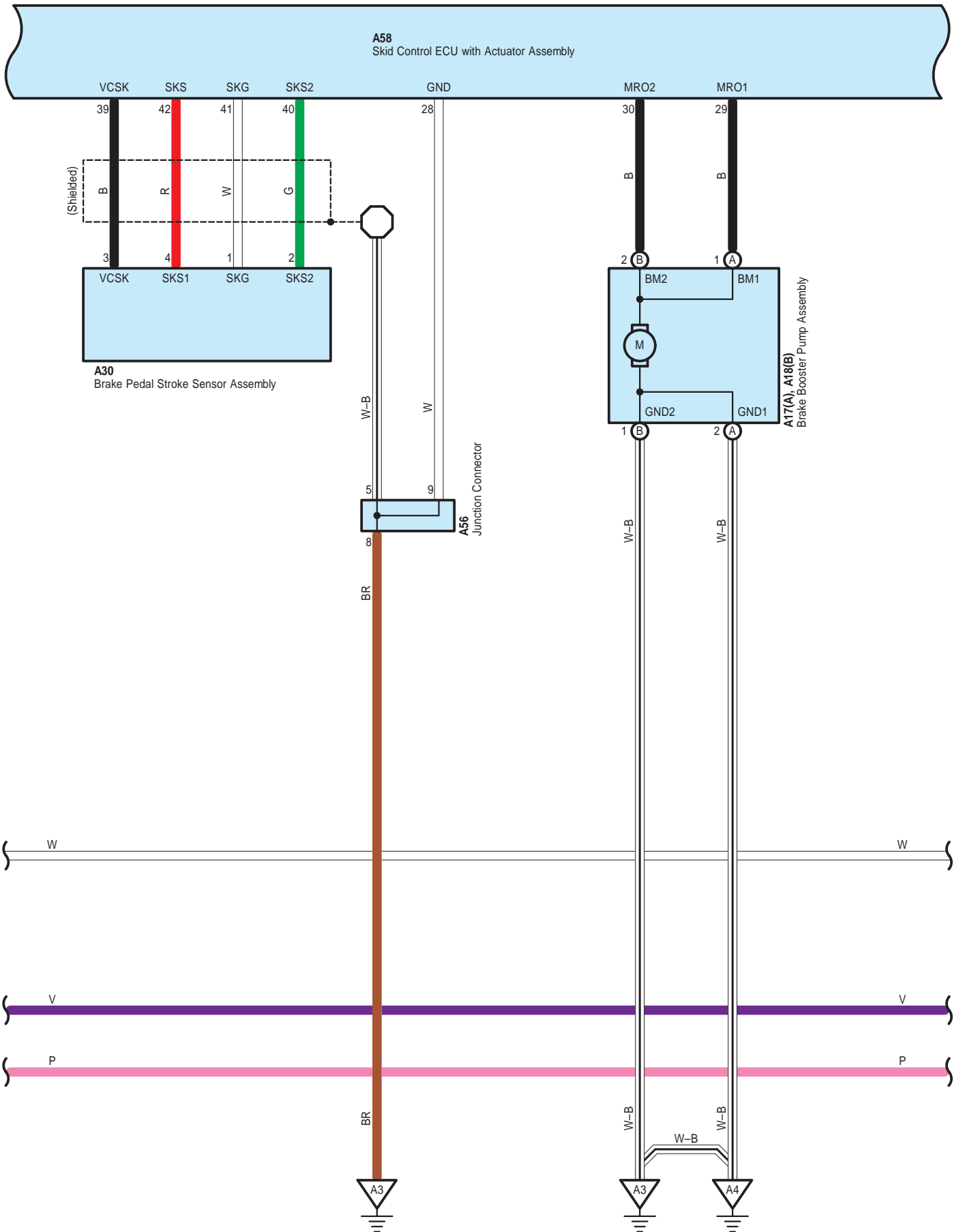

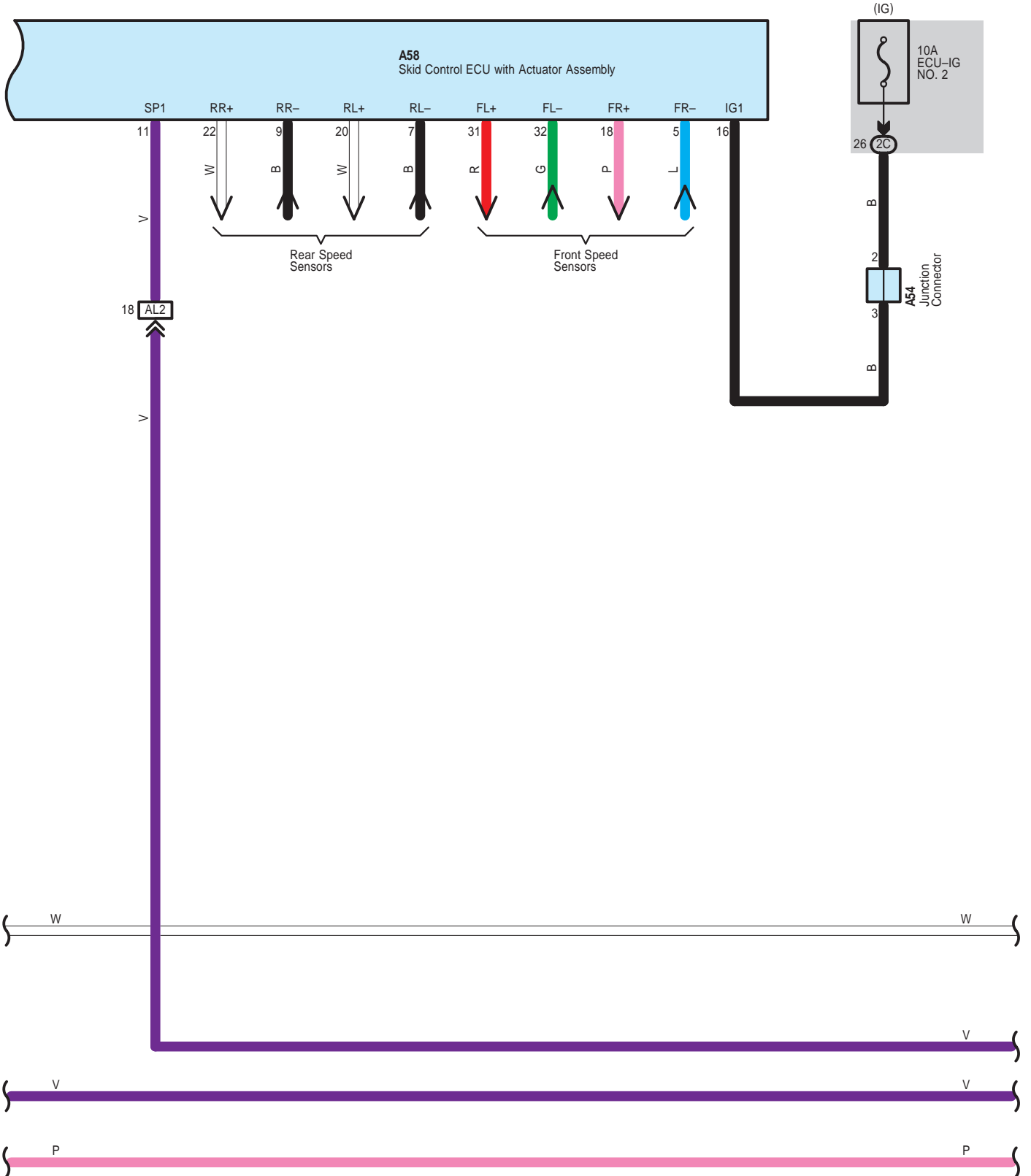

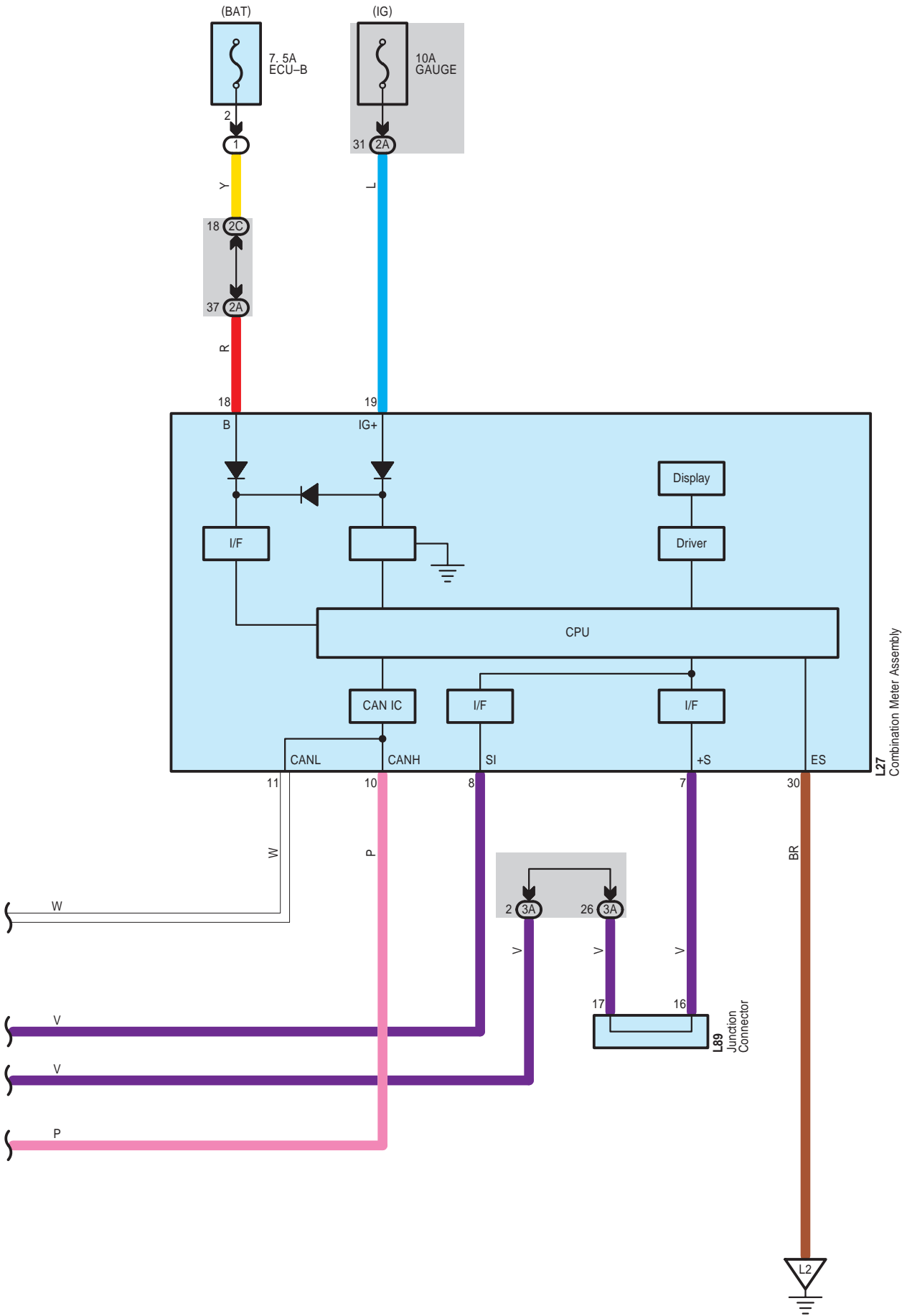



A 57  
Black

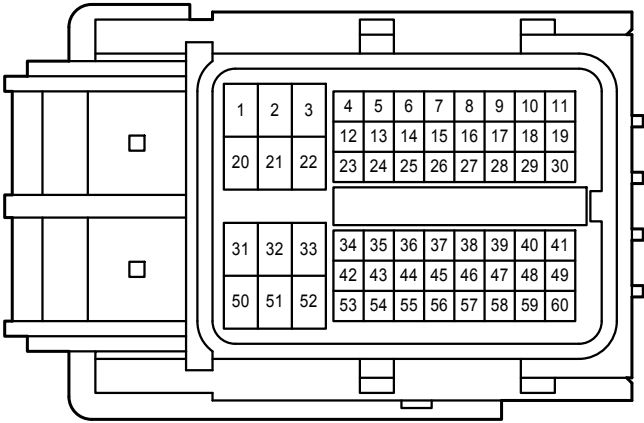

A 58  
Gray

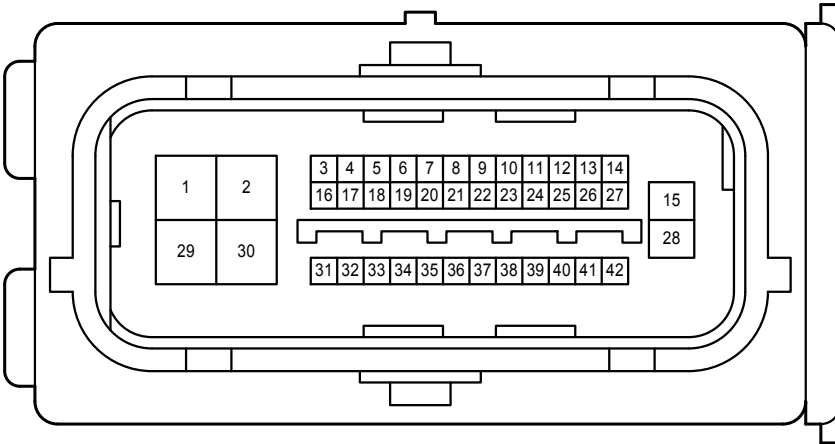

A 59  
Black

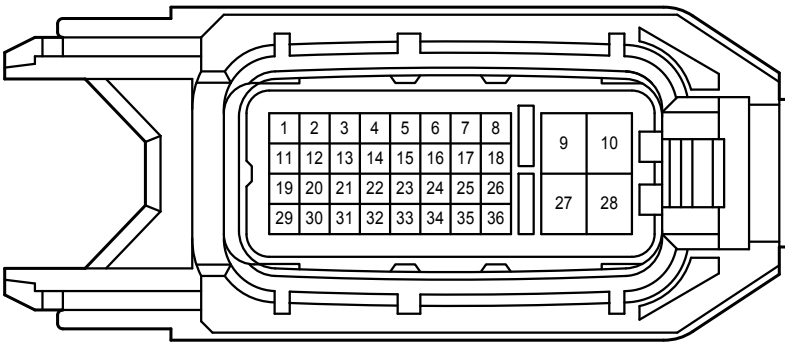

B 1

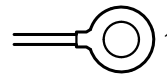

D 1  
Black

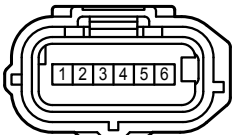

D 2  
Black

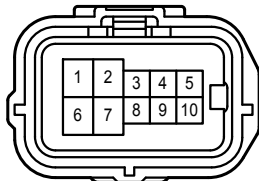

D 4  
Black

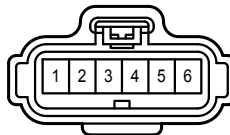

D 7  
Gray

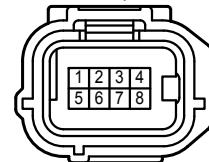





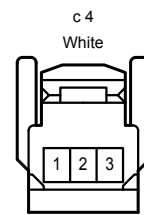
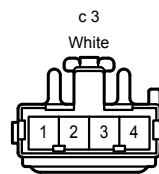
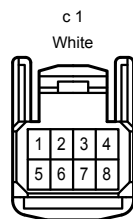
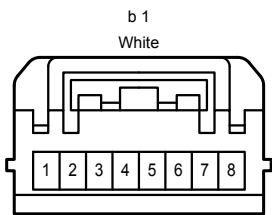
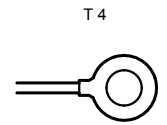
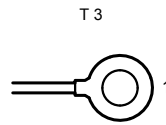
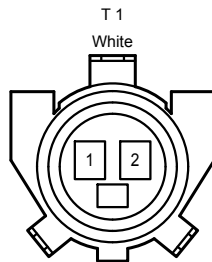
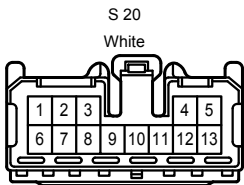
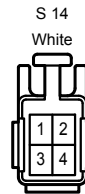
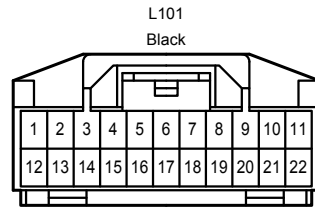
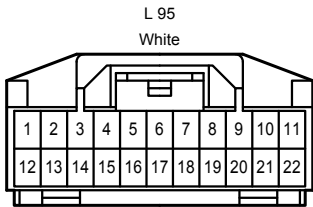
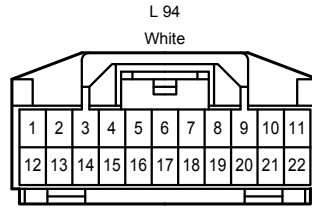
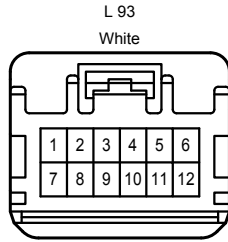
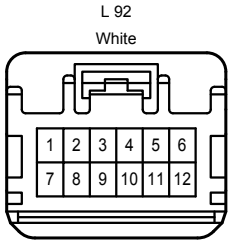
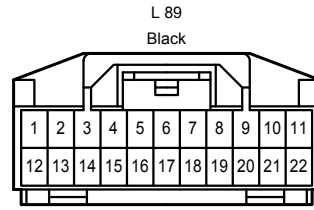
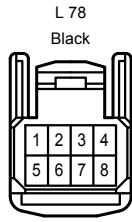
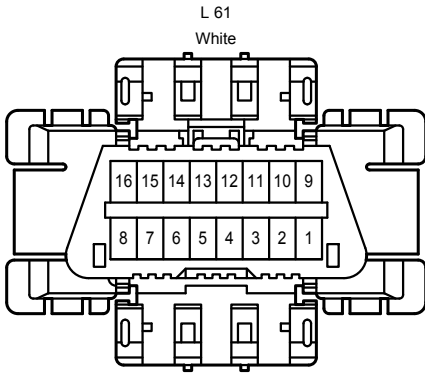

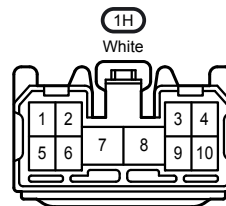
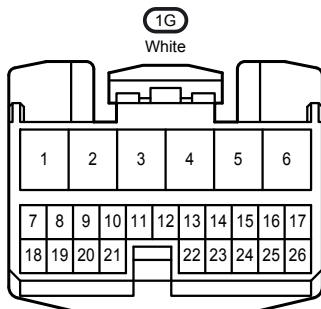
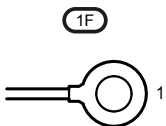
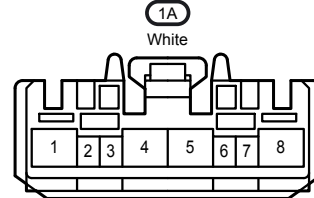
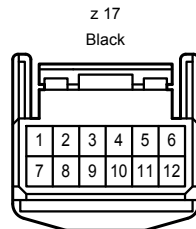
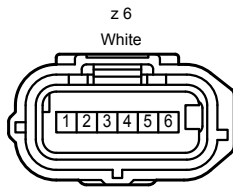
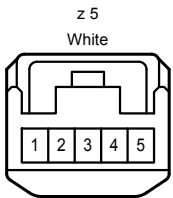
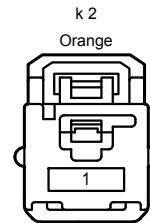
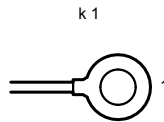
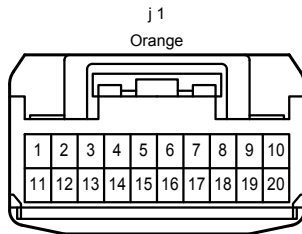
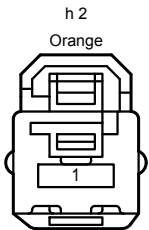
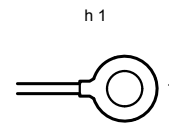
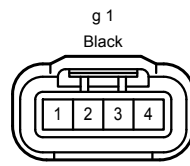
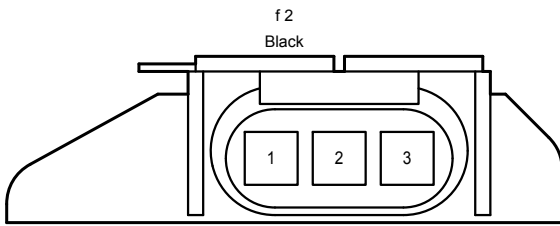
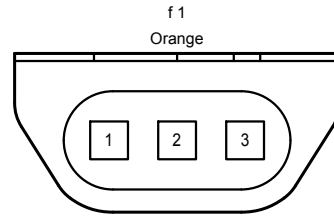
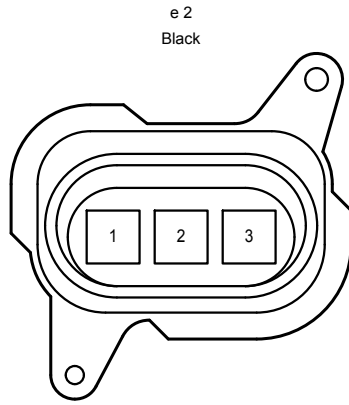
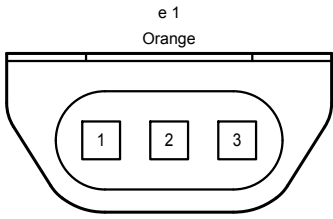

2A

White

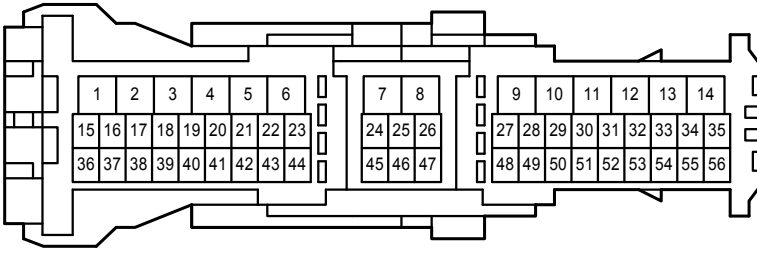

2C

White

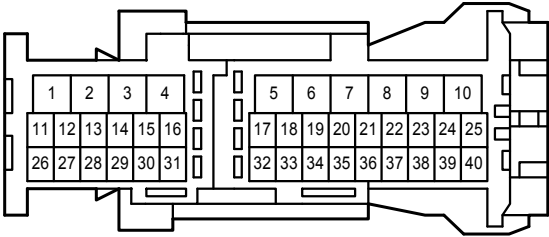

3A

White

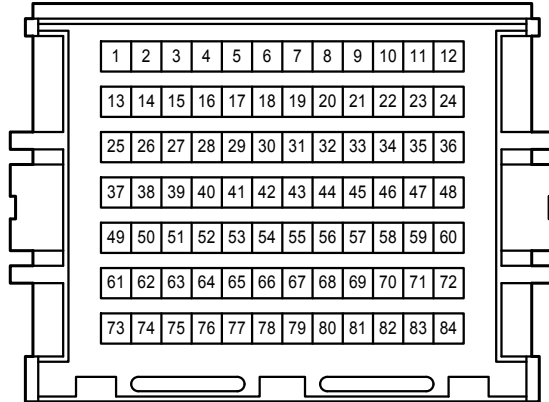

3B

White

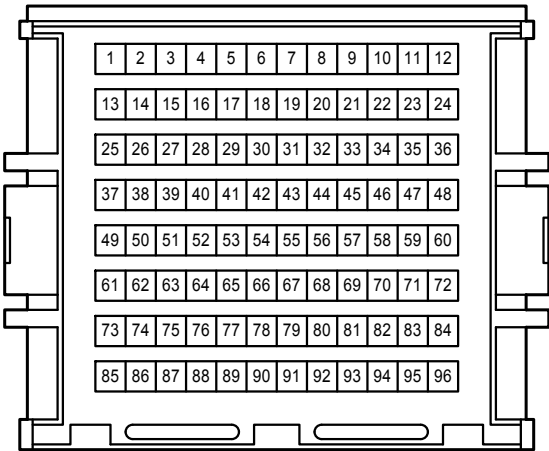

AL1

Blue

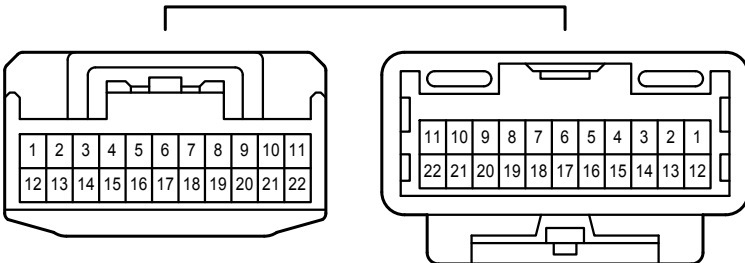

AL2  
Gray

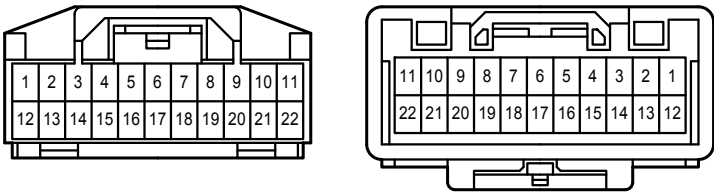

AL3  
White

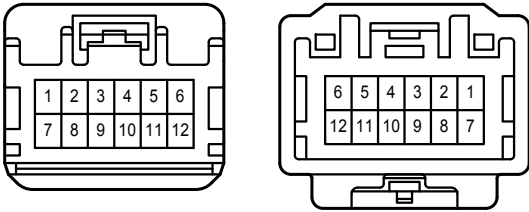

AL8  
White

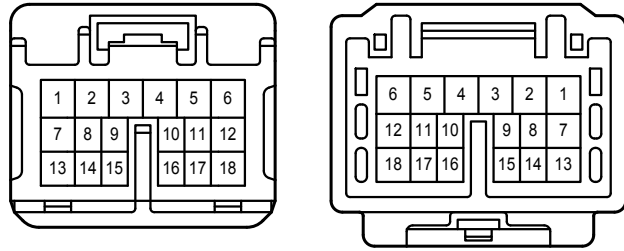

AS1  
White

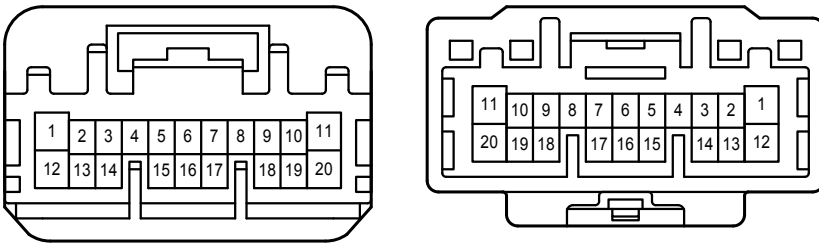

Ag1  
Black

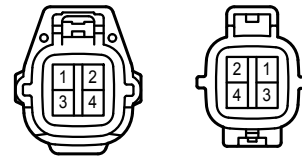

DA1  
White

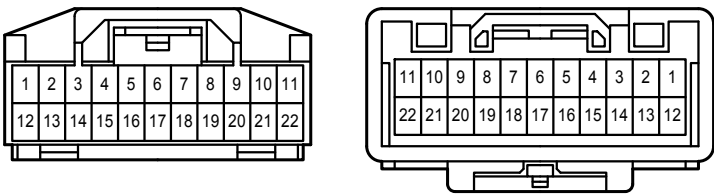

DA2  
White

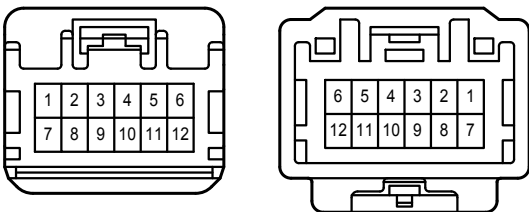

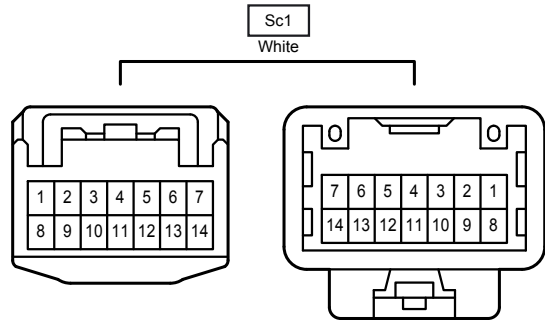
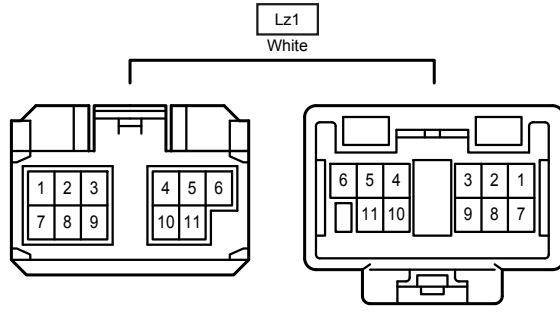
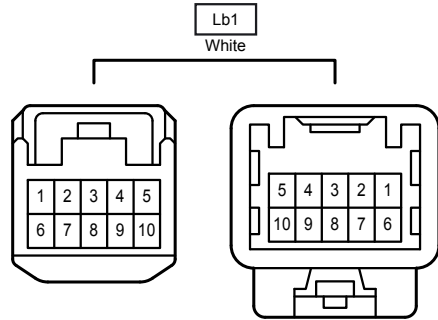
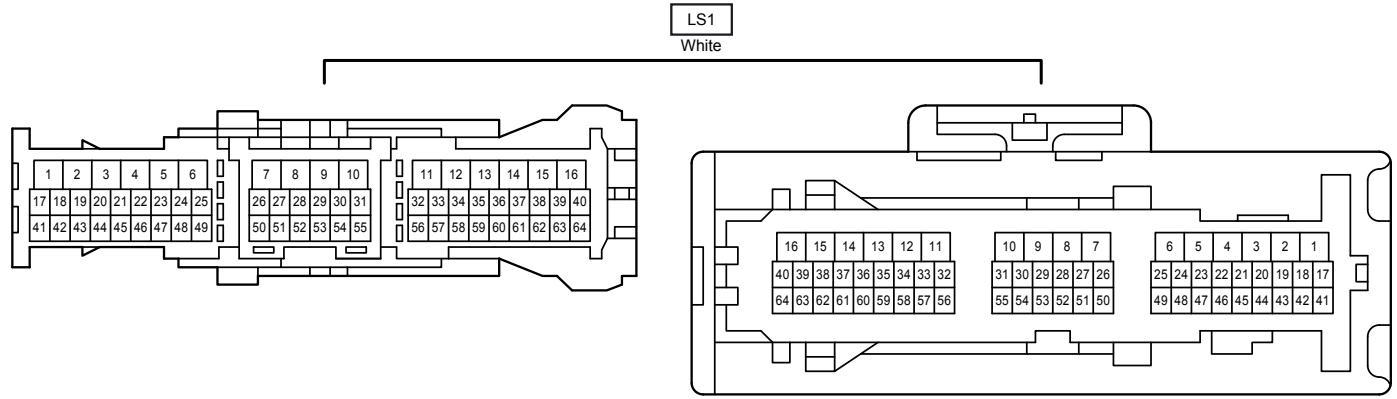

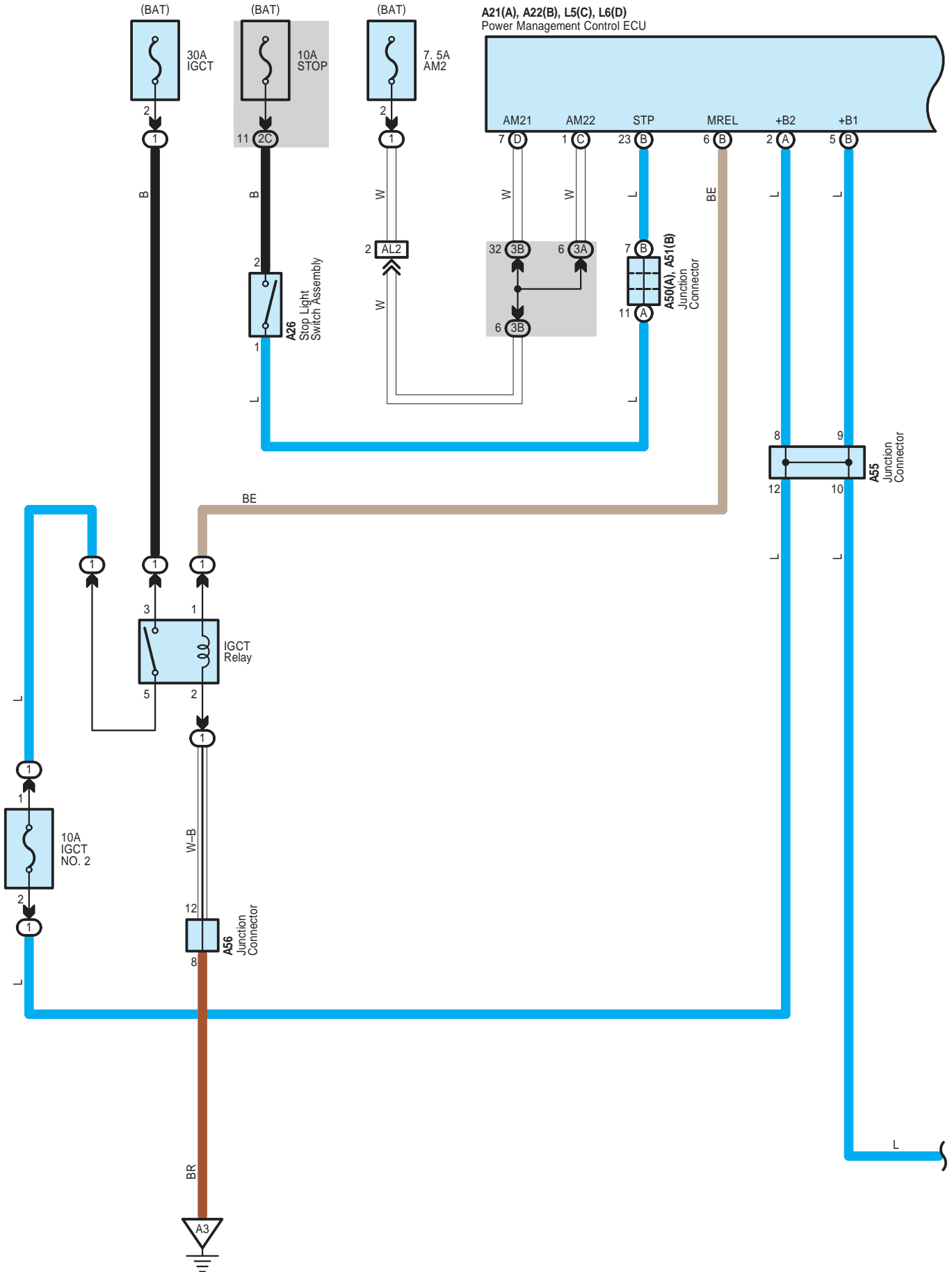

A21(A), A22(B), L5(C), L6(D)  
Power Management Control ECU

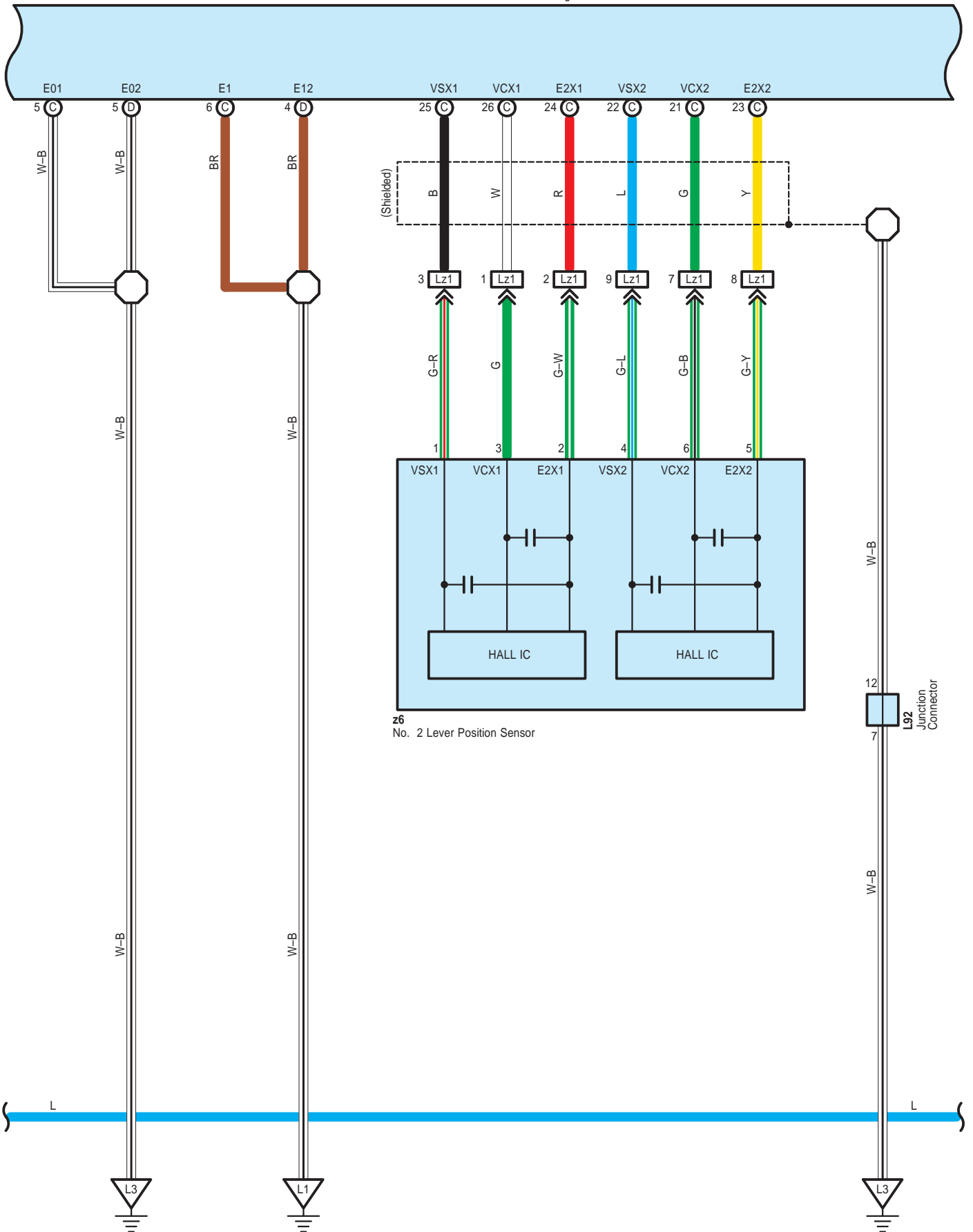



A21(A), A22(B), L5(C), L6(D)  
Power Management Control ECU

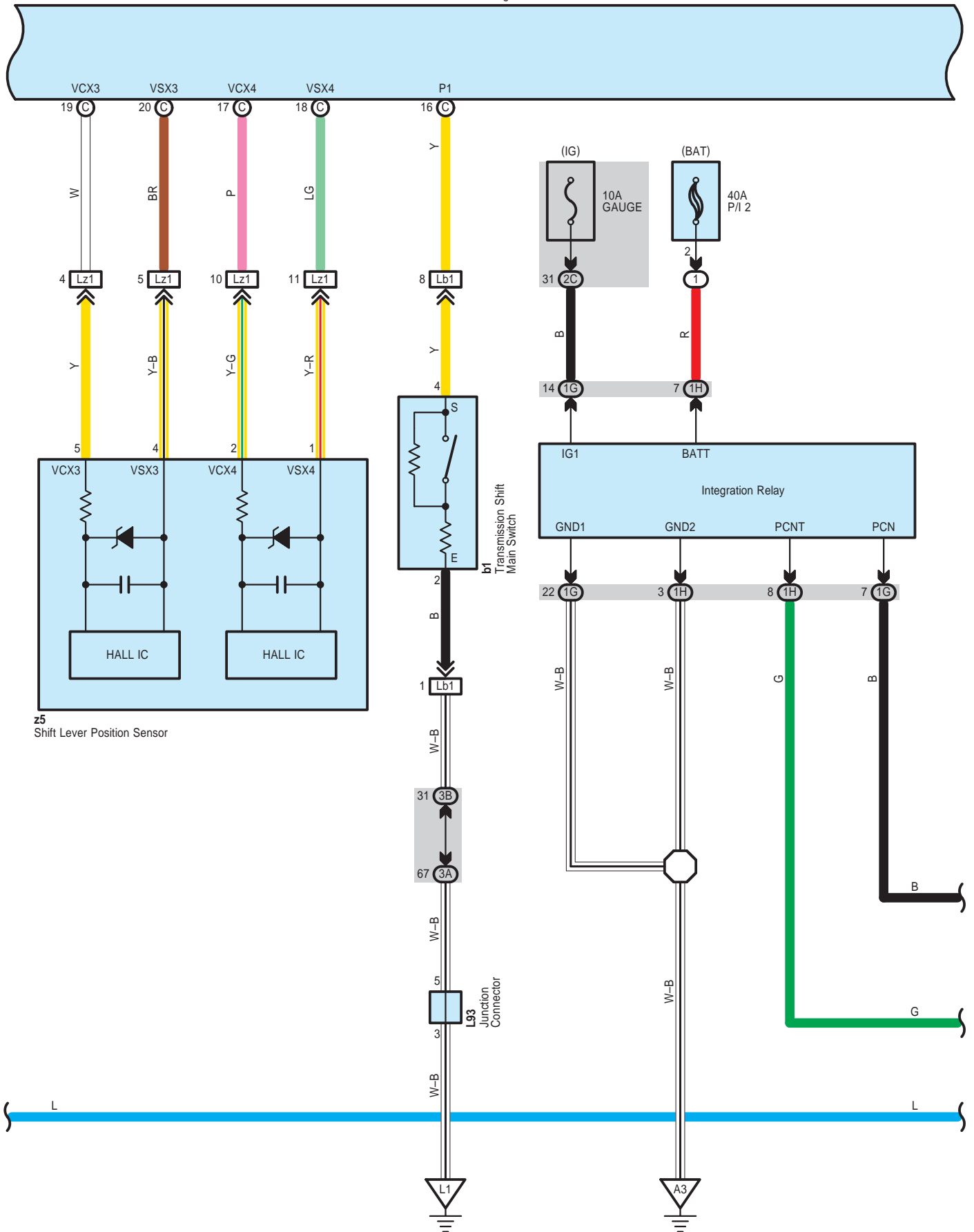

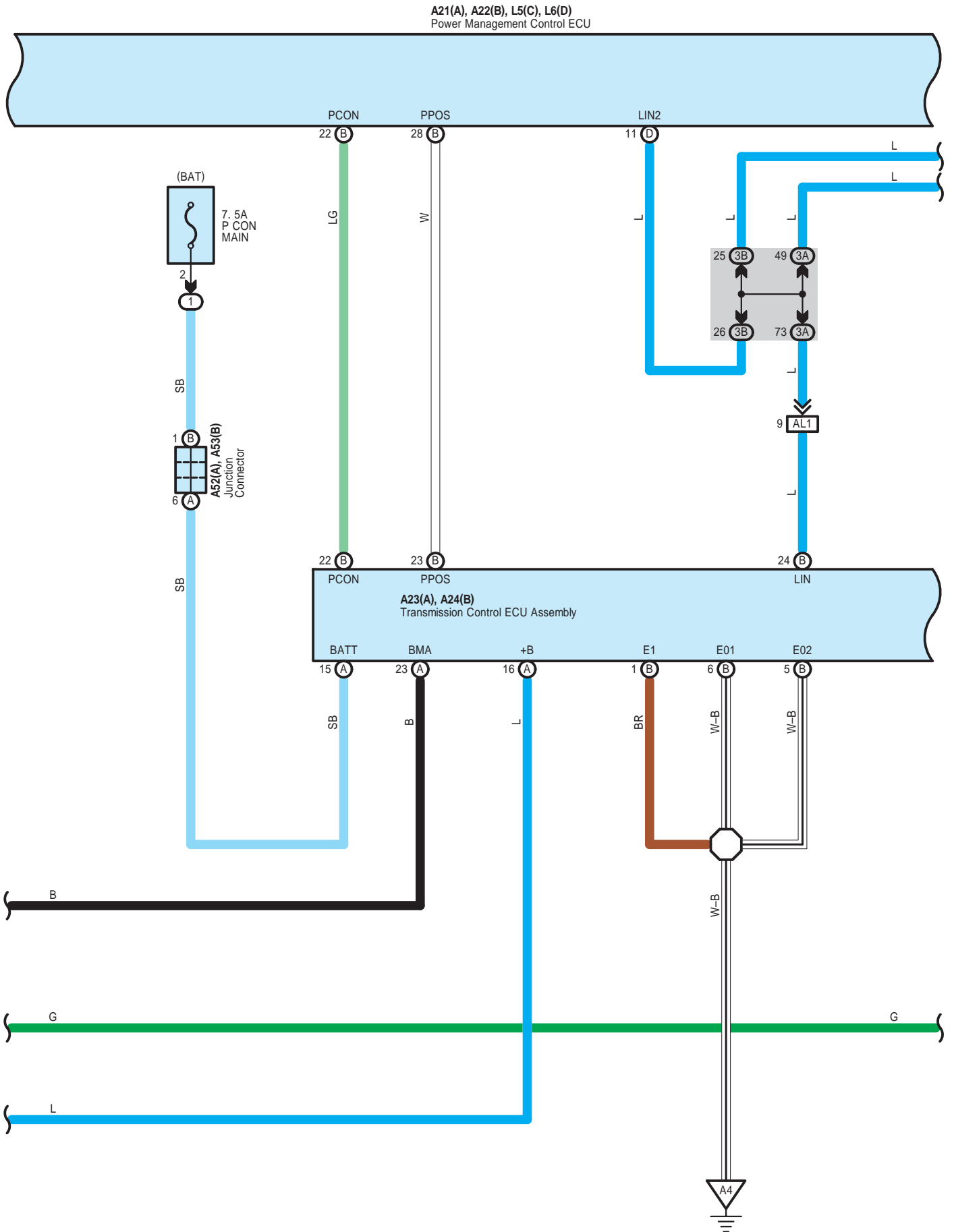

A21(A), A22(B), L5(C), L6(D)  
Power Management Control ECU

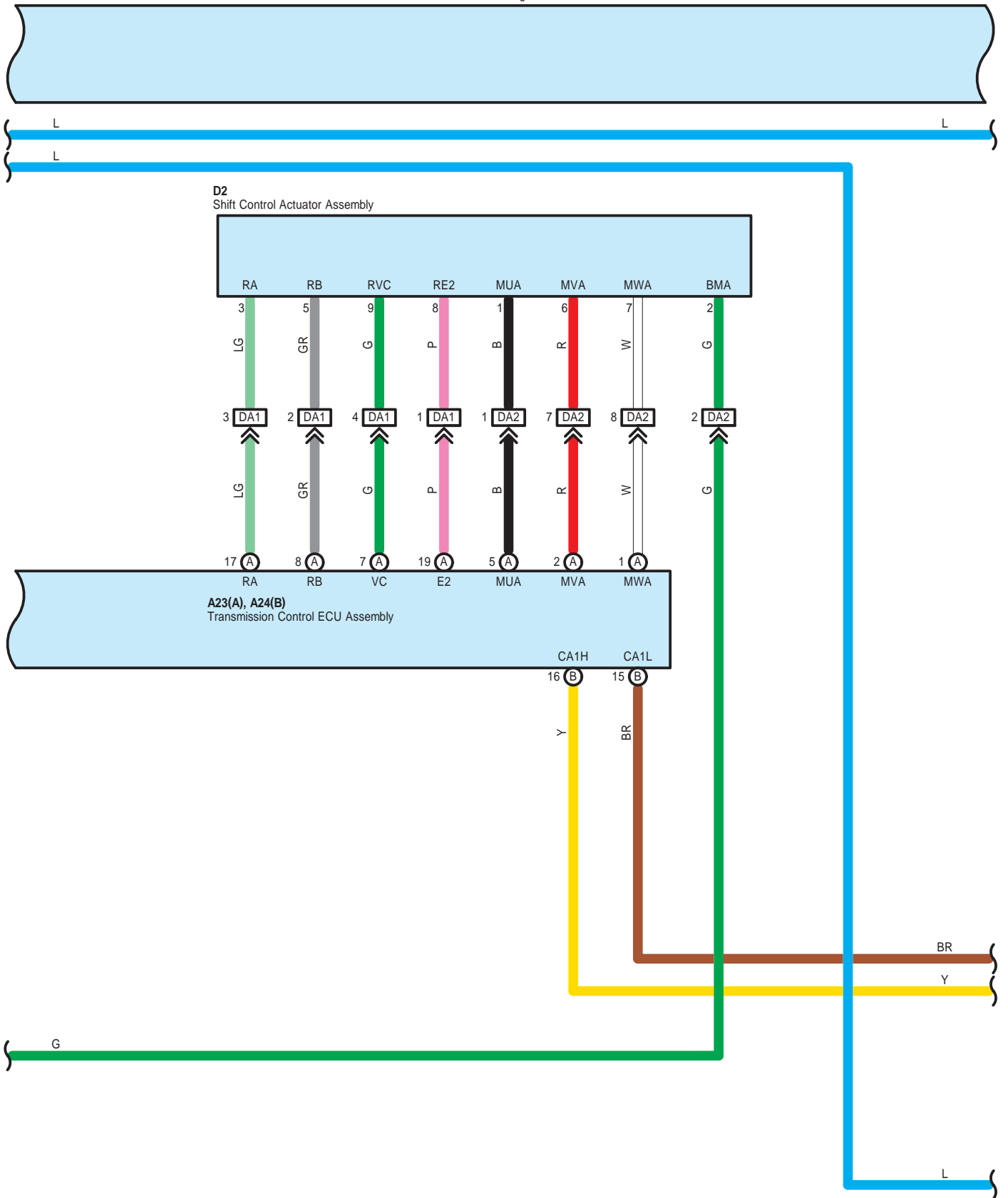

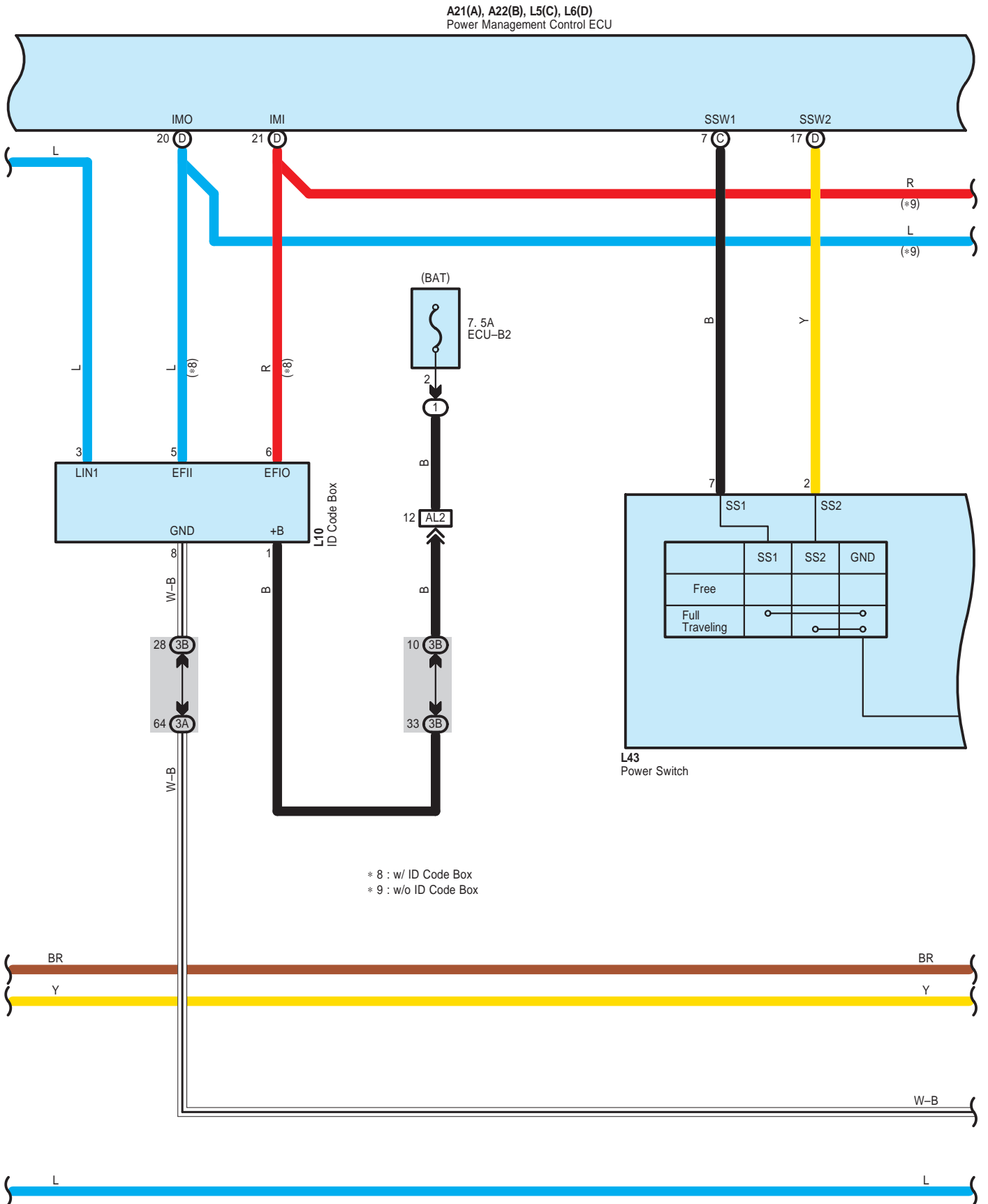

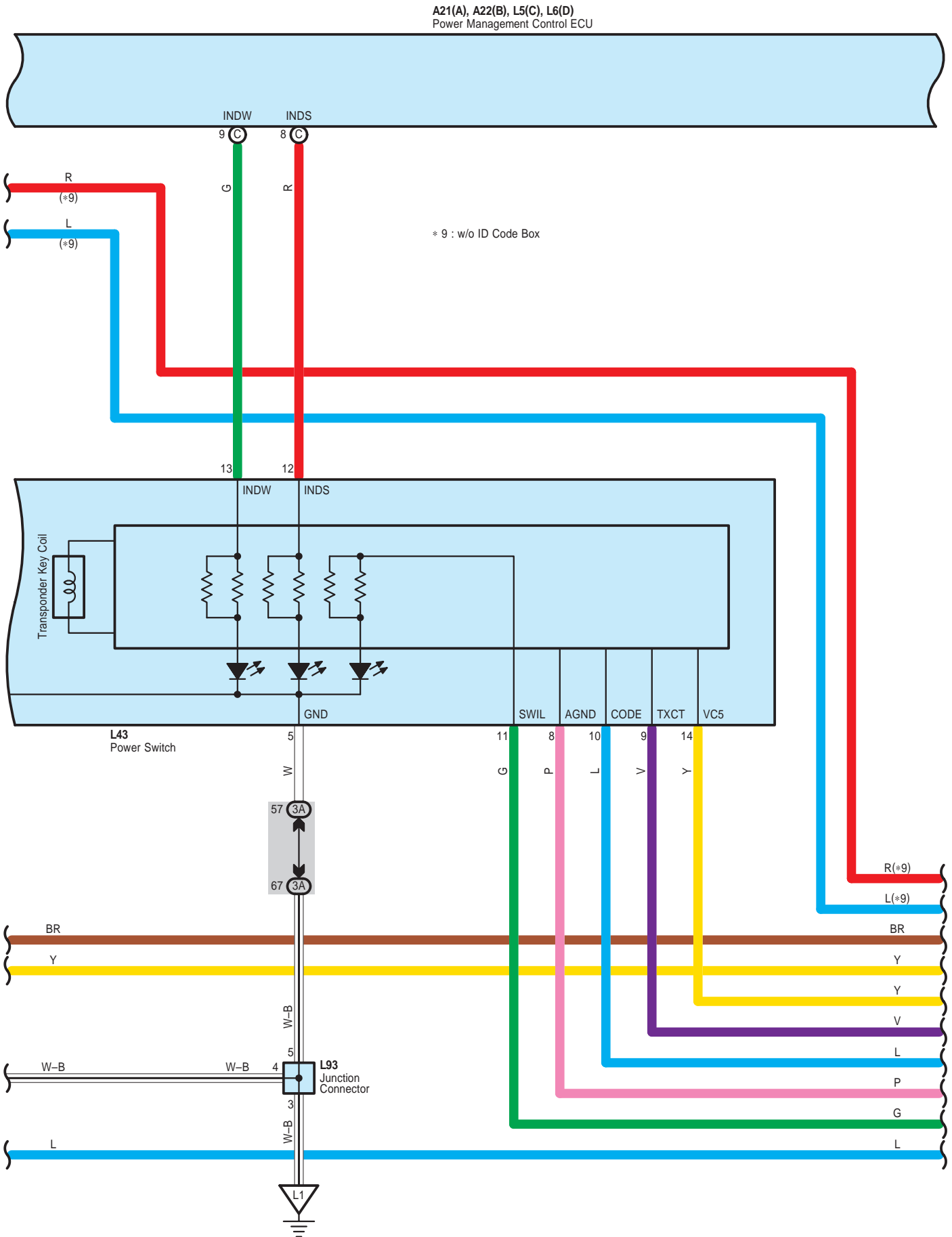

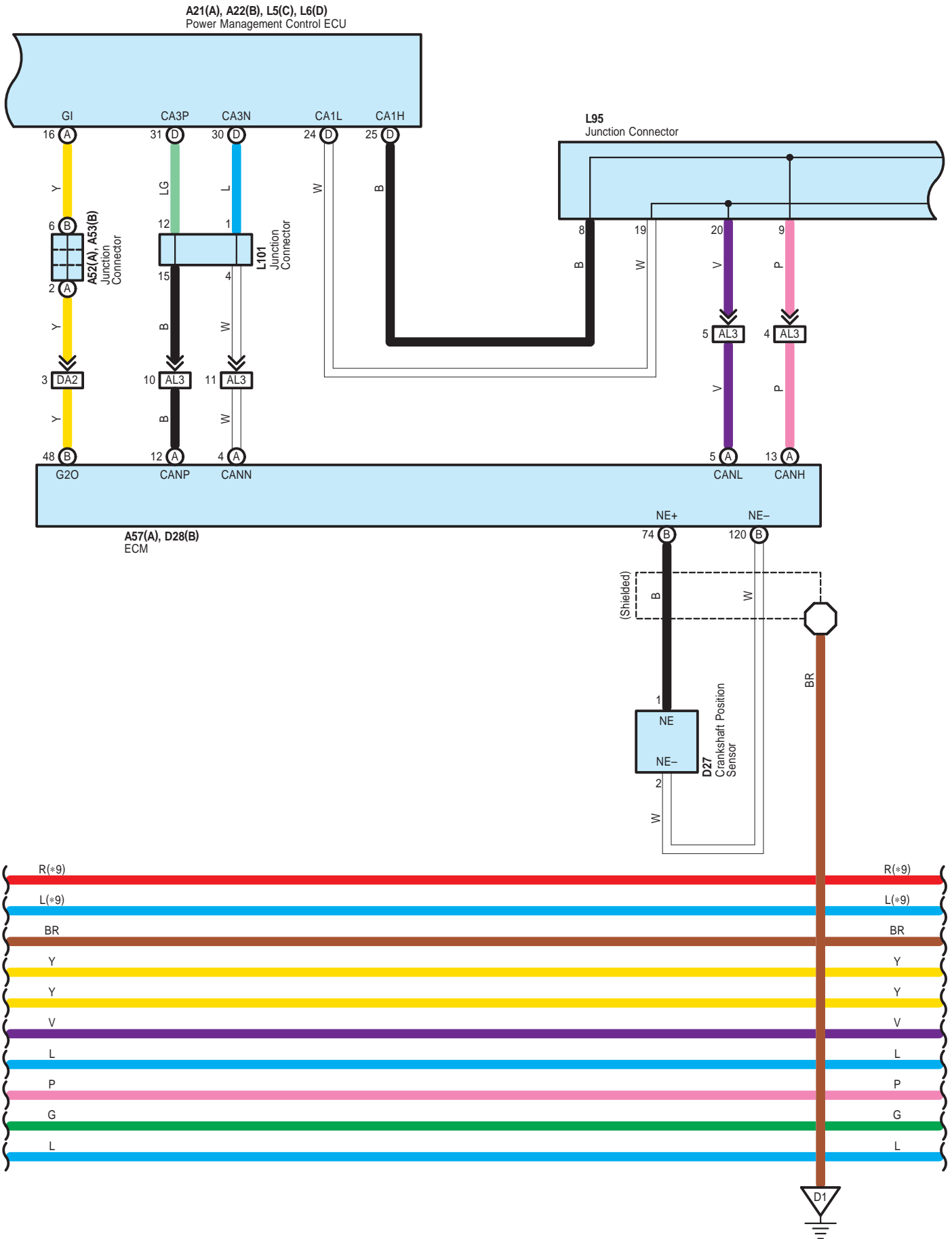

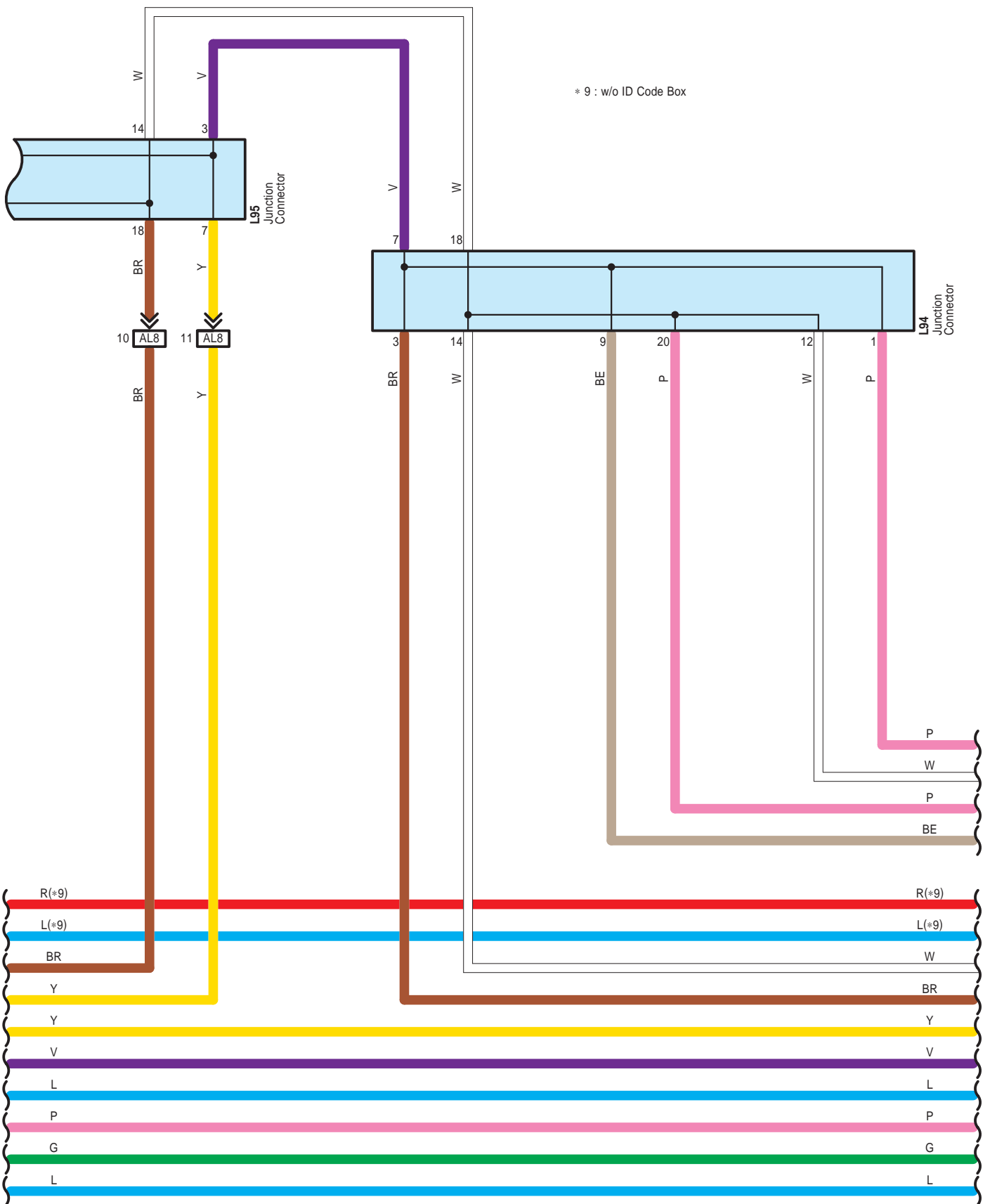

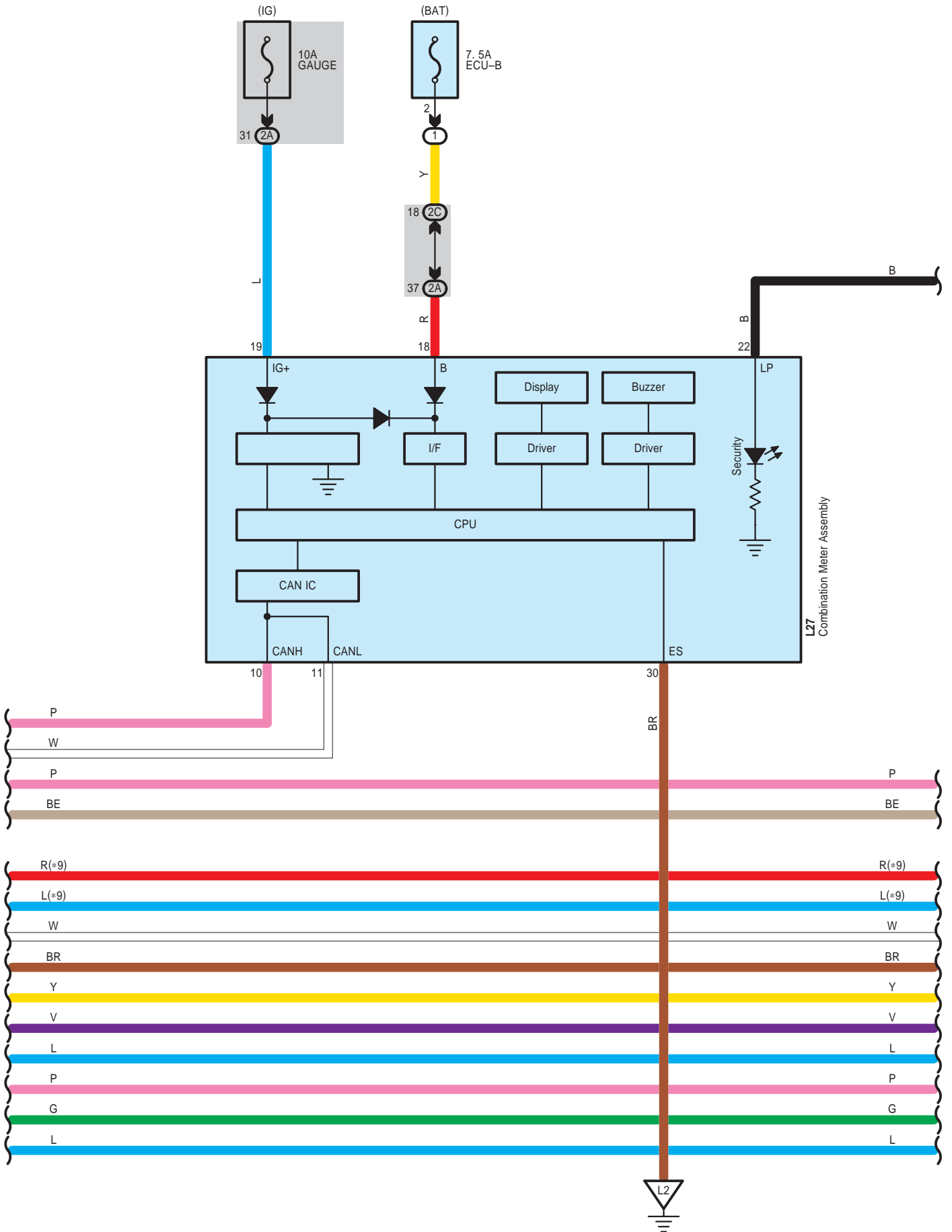



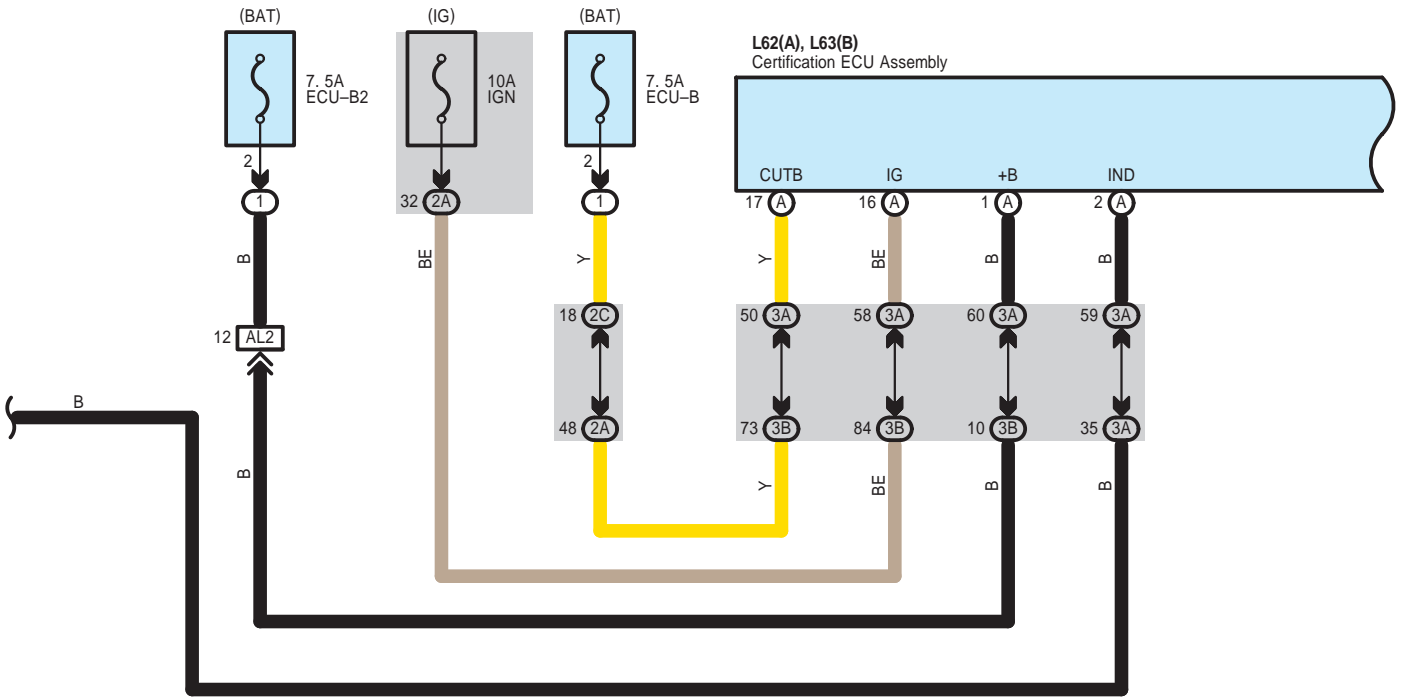

\* 9 : w/o ID Code Box



L62(A), L63(B)  
Certification ECU Assembly

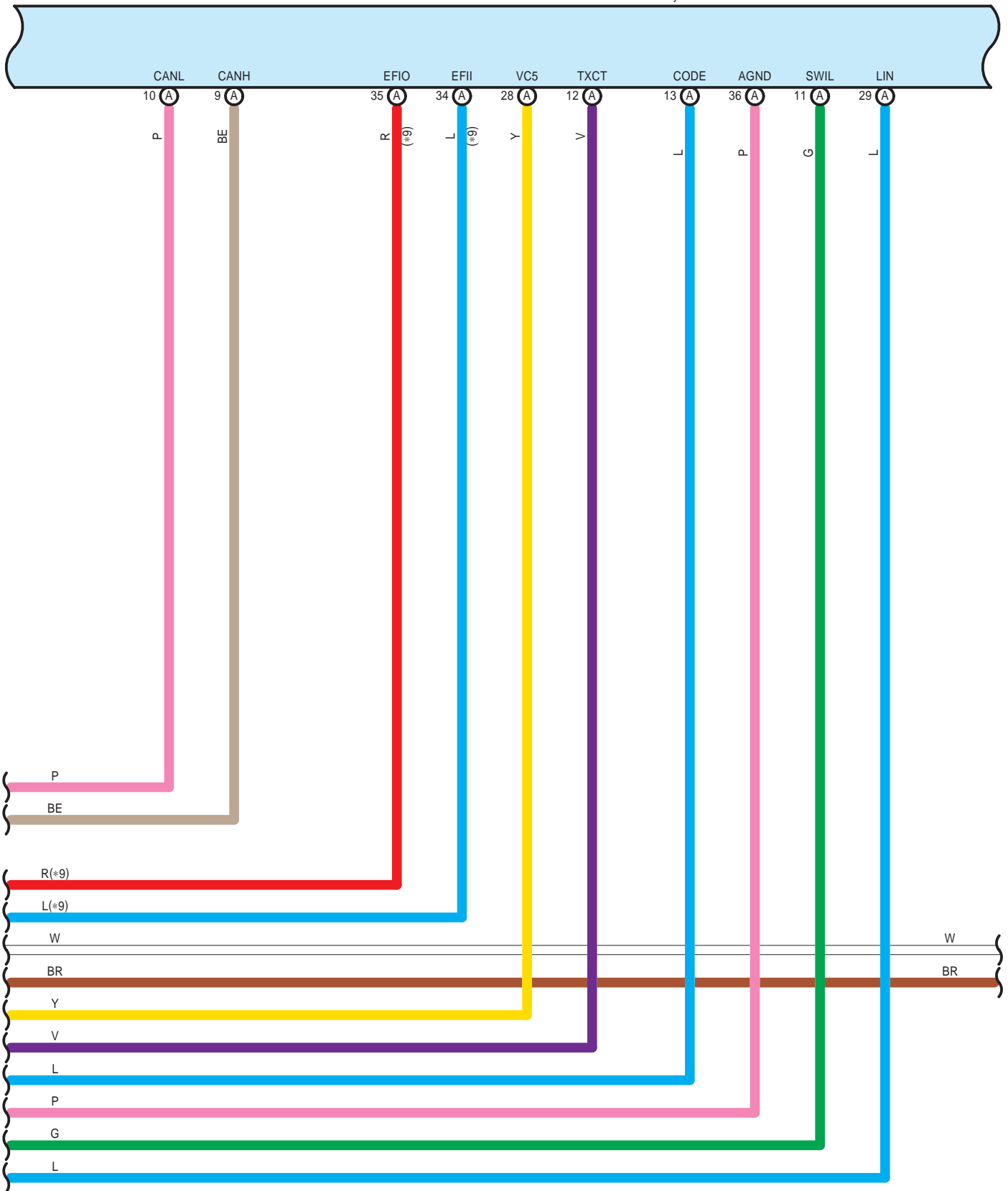

L62(A), L63(B)  
Certification ECU Assembly

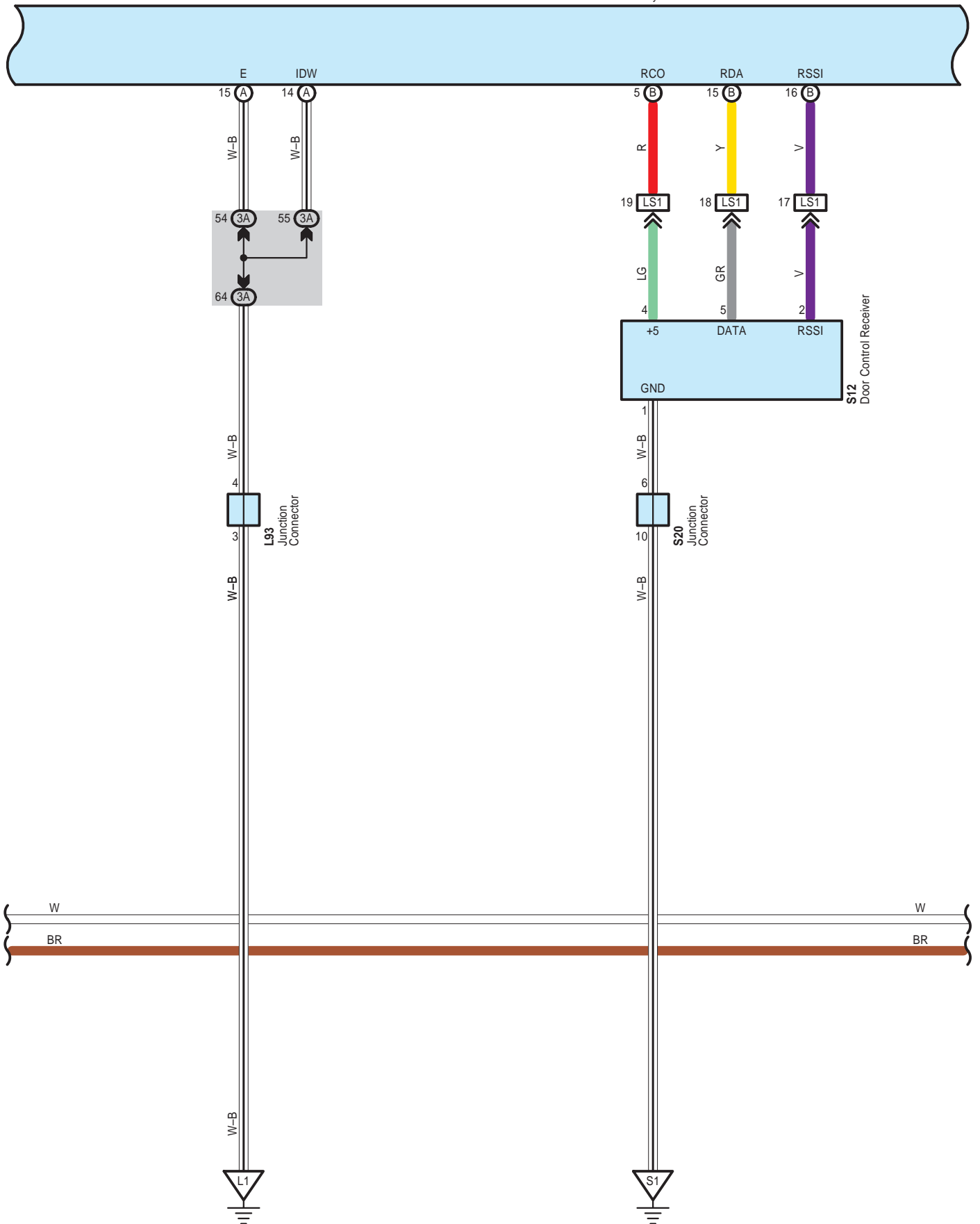

L62(A), L63(B)  
Certification ECU Assembly

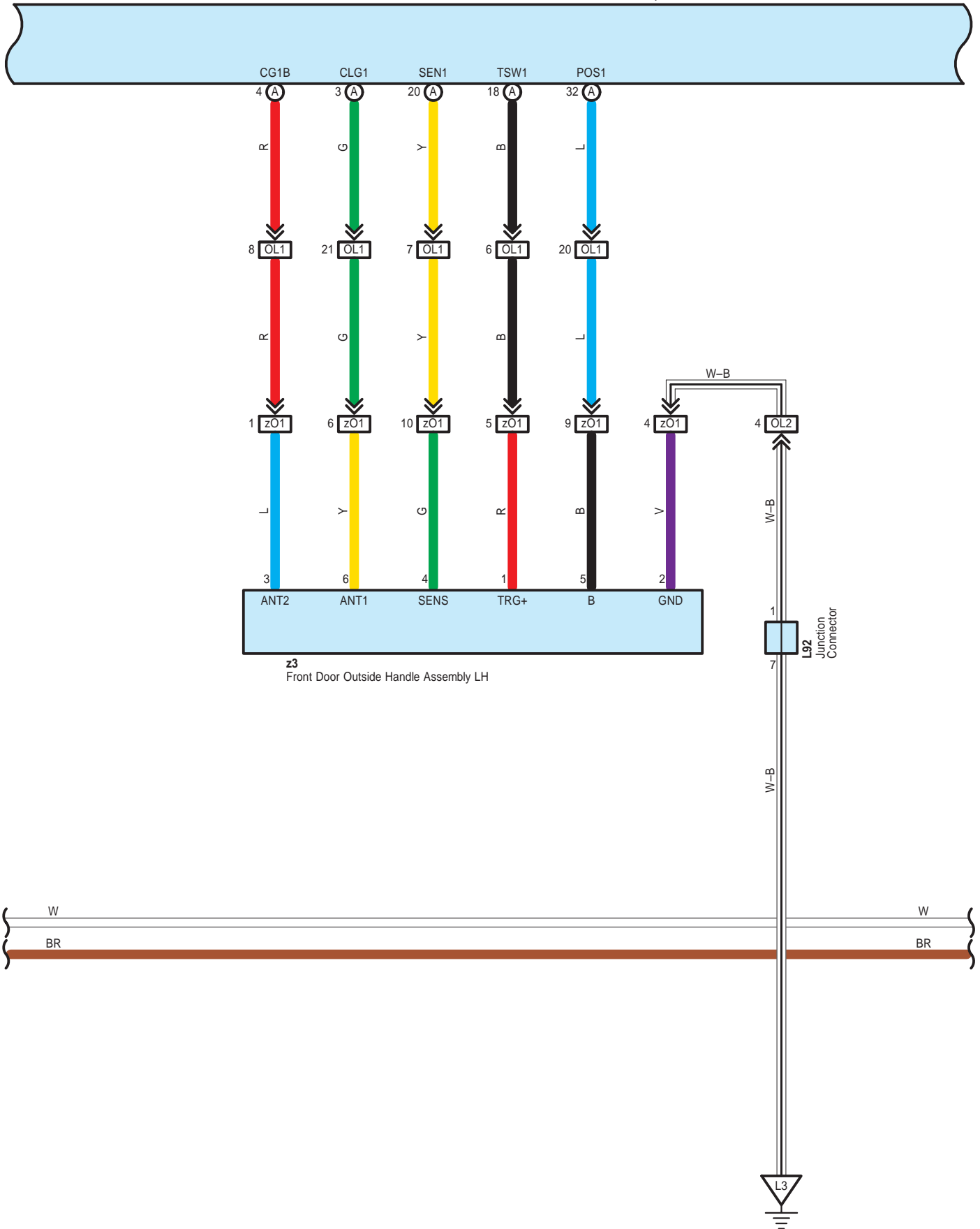

L62(A), L63(B)  
Certification ECU Assembly

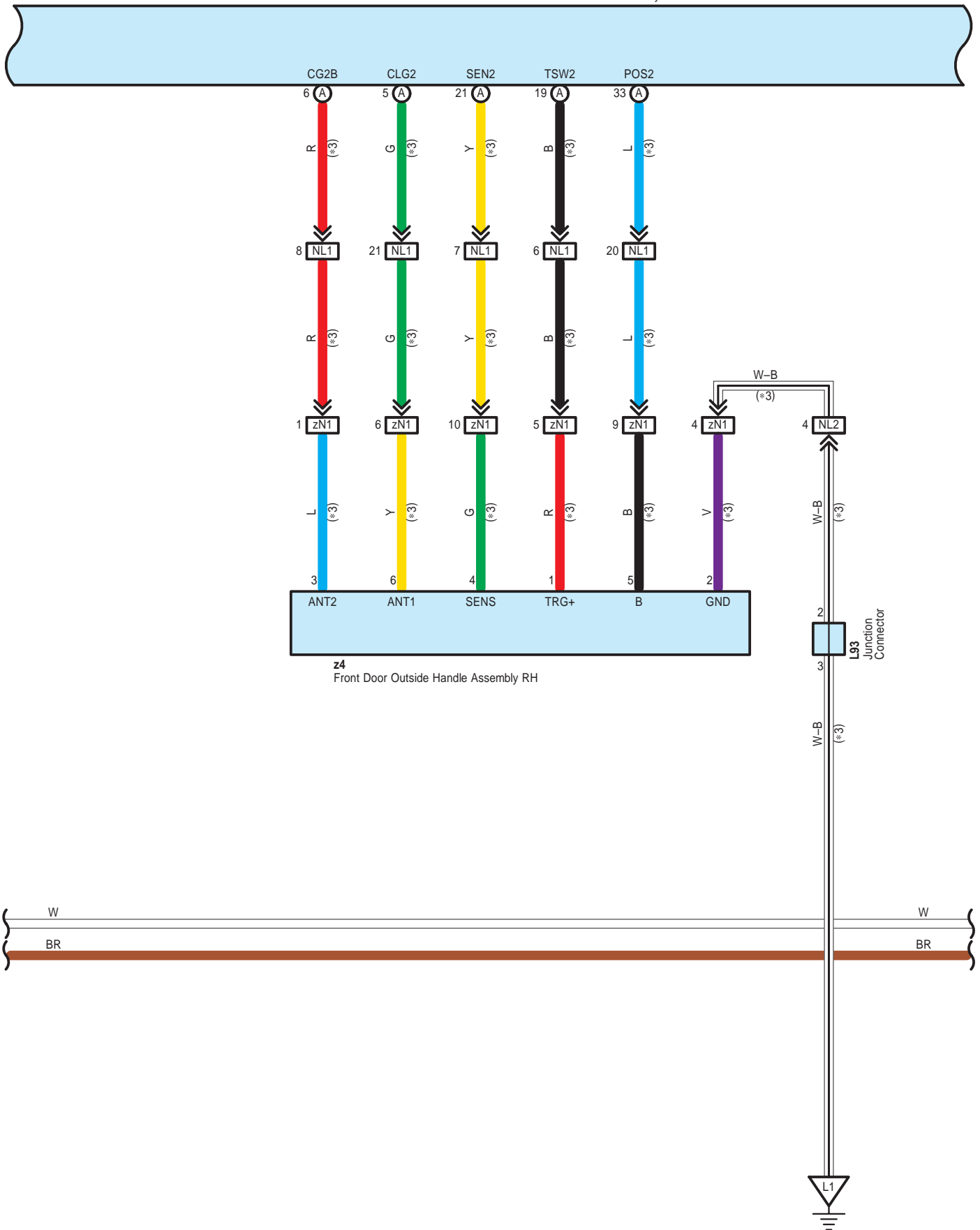

L62(A), L63(B)  
Certification ECU Assembly

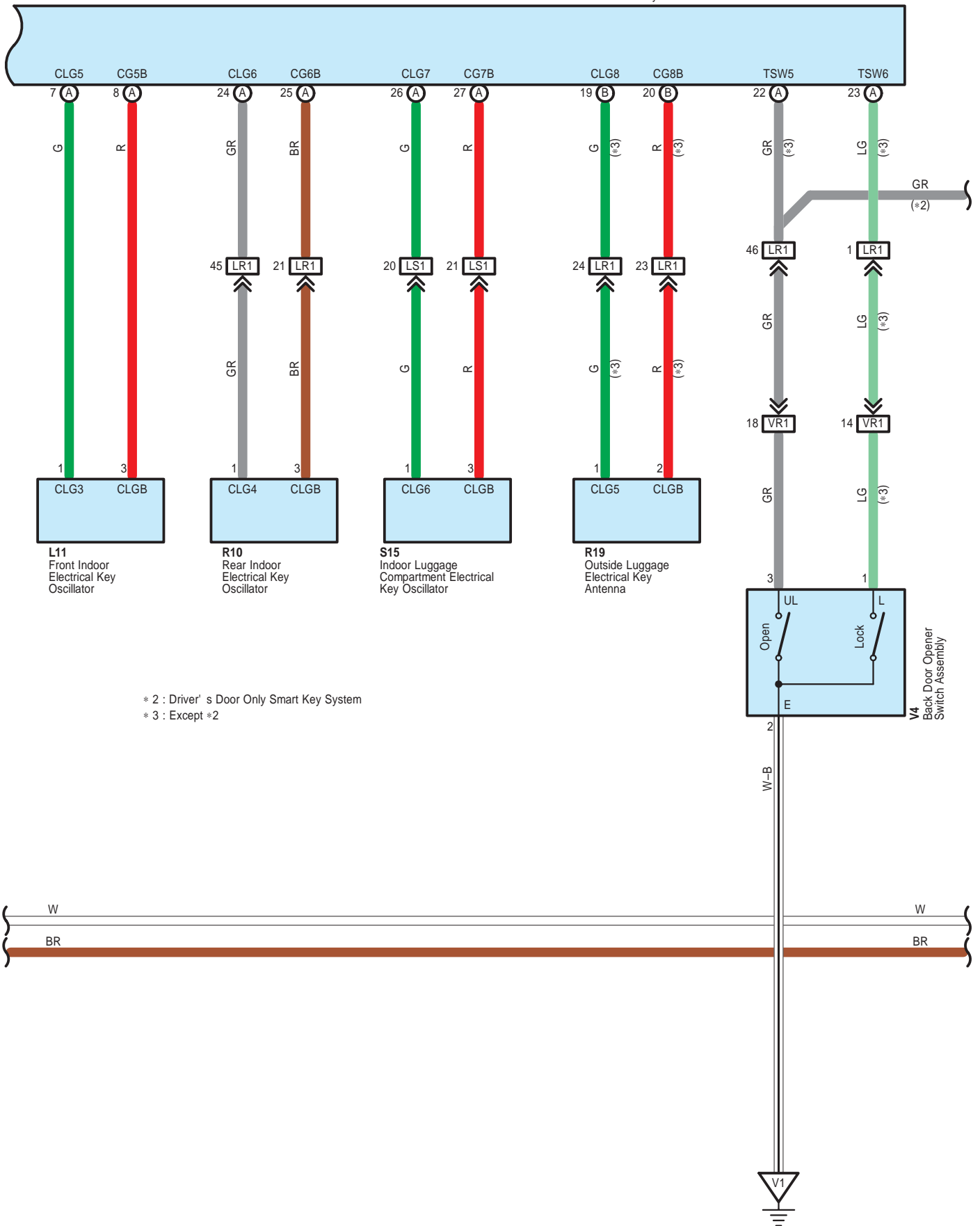

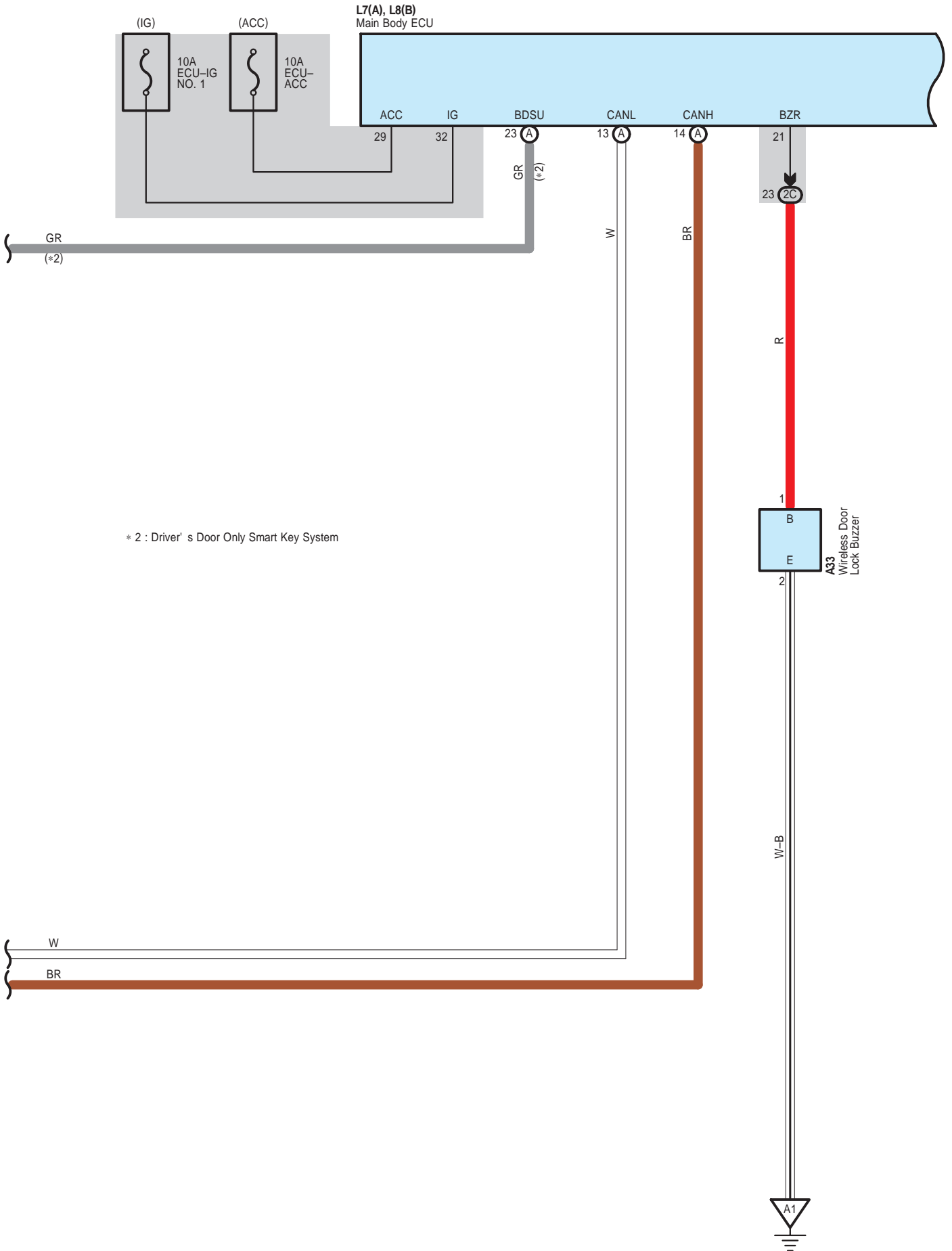

L7(A), L8(B)  
Main Body ECU

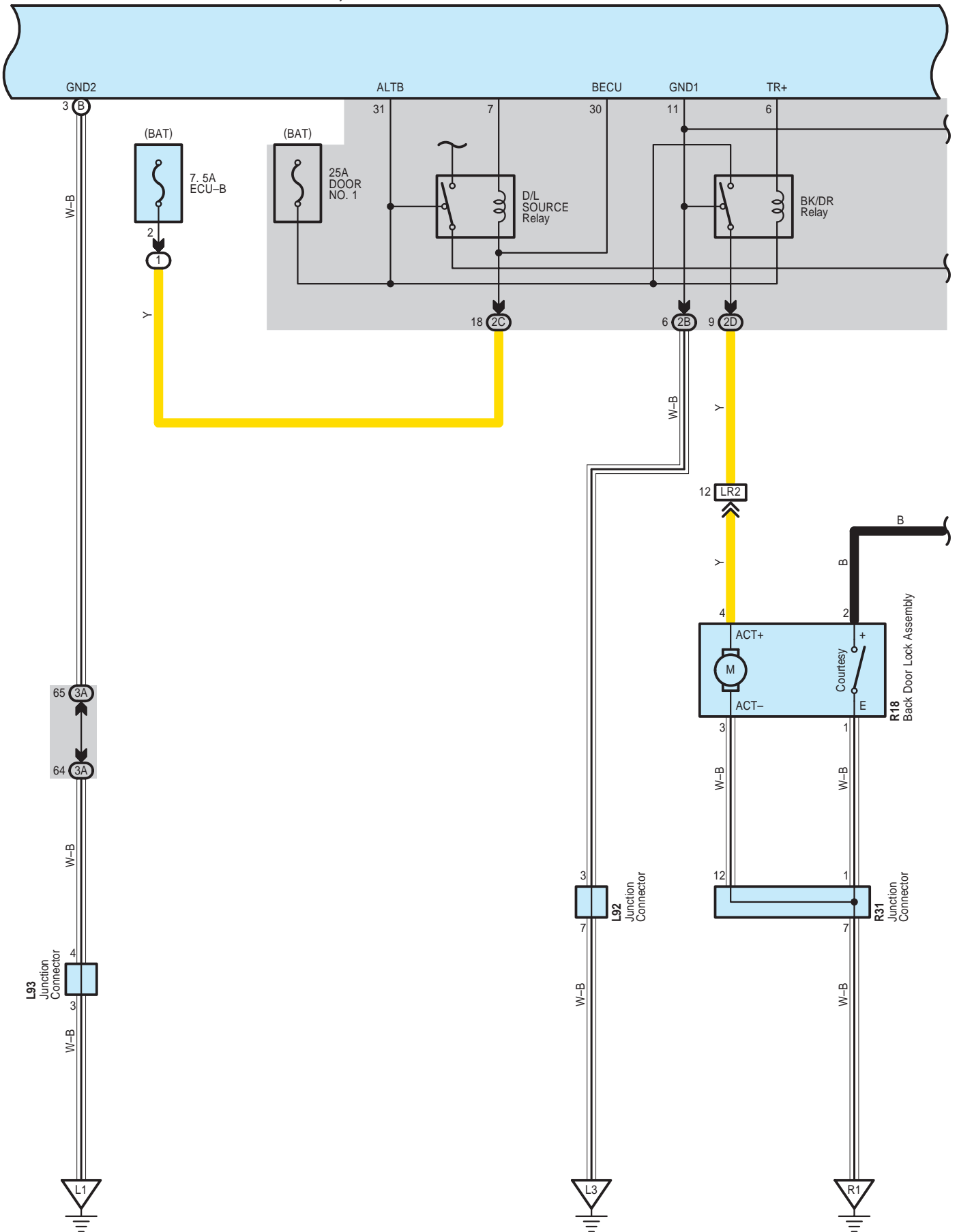





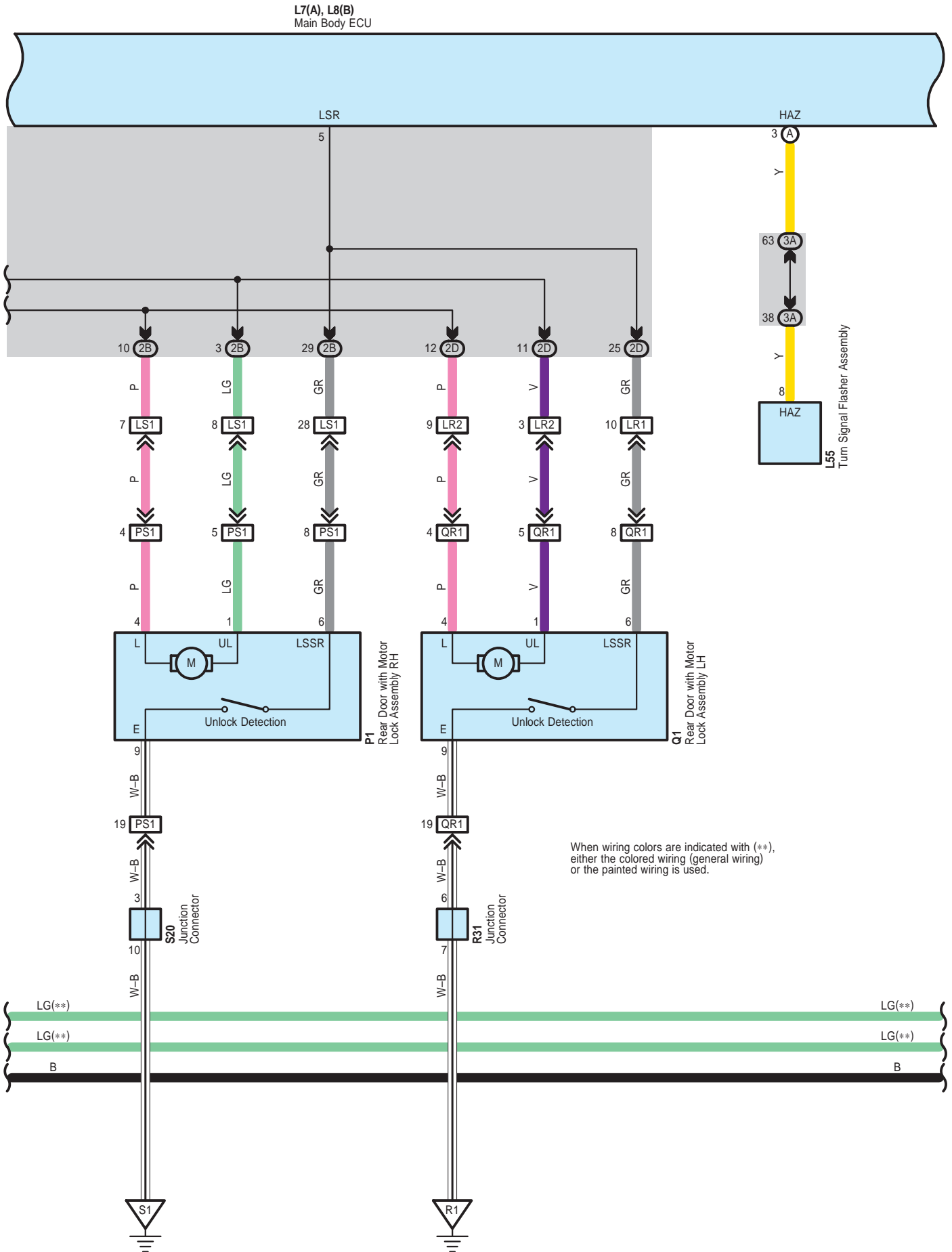

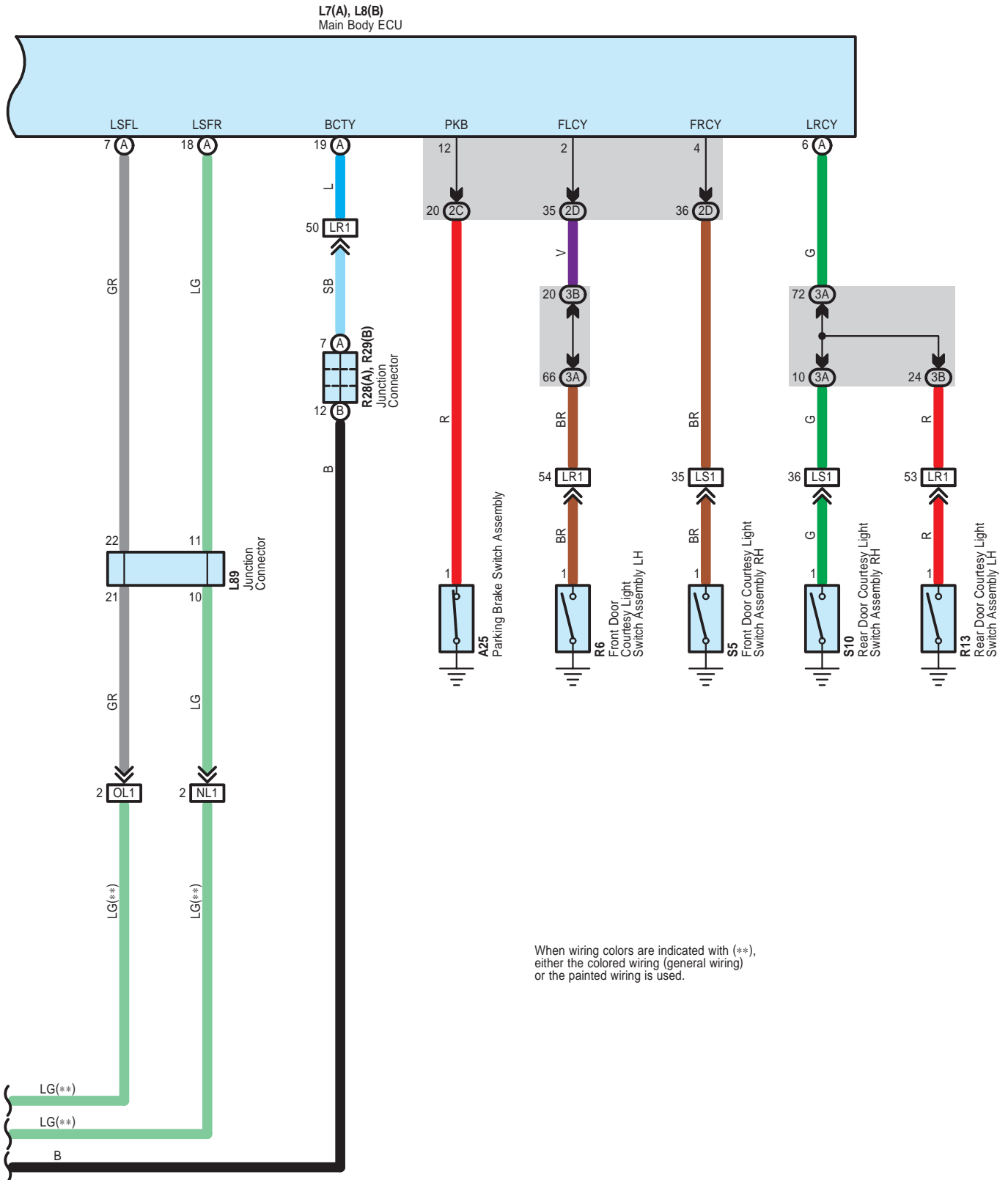

A 21  
Gray

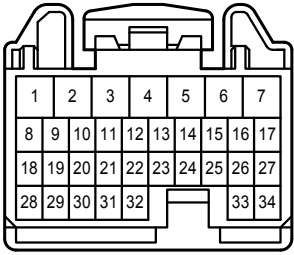

A 22  
Gray

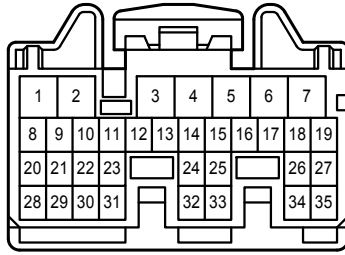

A 23  
White

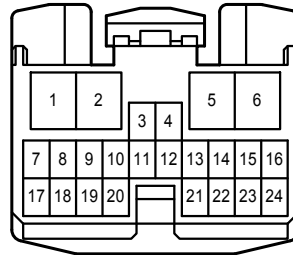

A 24  
White

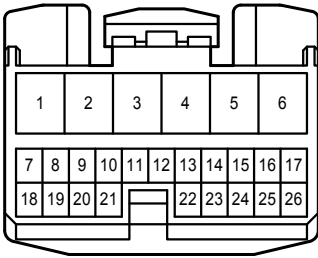

A 25  
White



A 26  
White

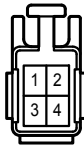

A 33  
Gray

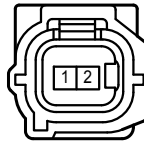

A 50  
White

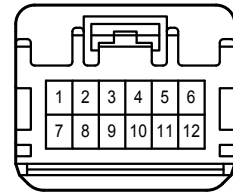

A 51  
White

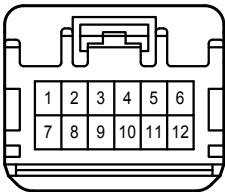

A 52  
Black

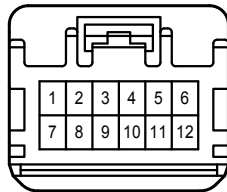

A 53  
Black

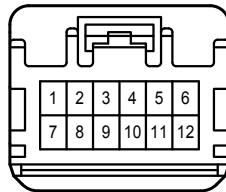

A 55  
Black

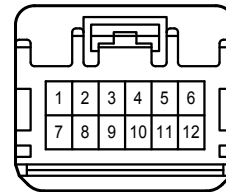

A 56  
White

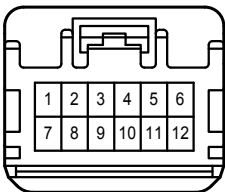

A 57  
Black

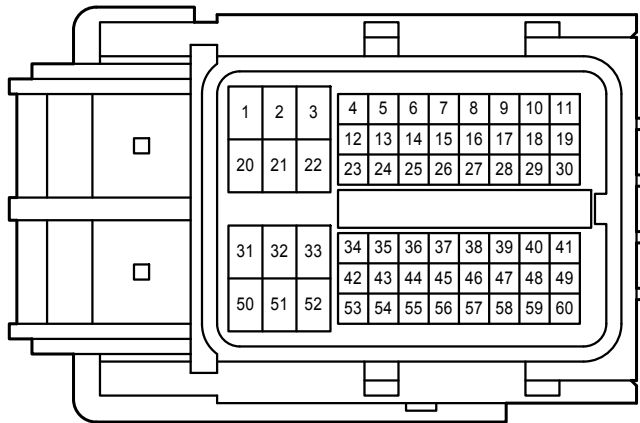

D 2  
Black

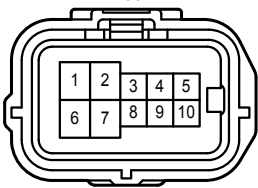

D 27  
Black

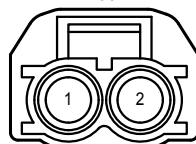

D 28  
Black

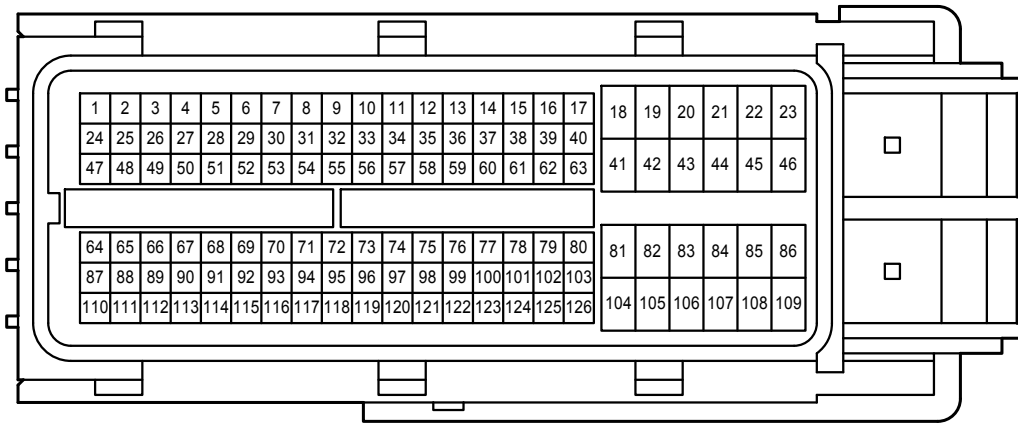

L 5  
Gray

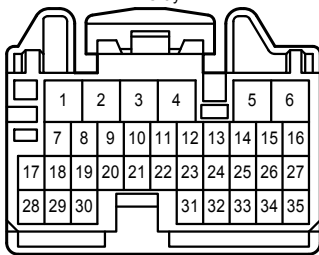

L 6  
Gray

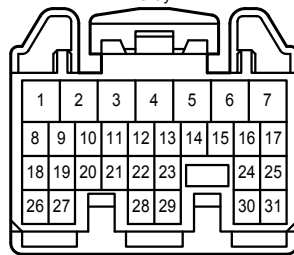

L 7  
White

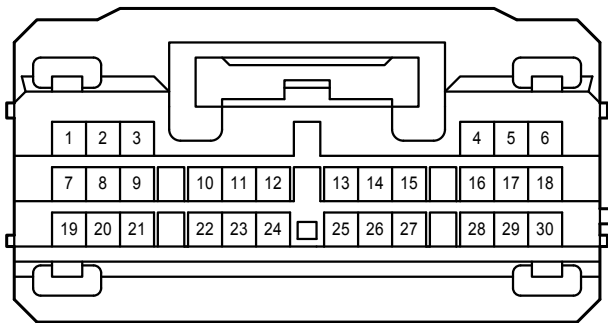

L 8  
White

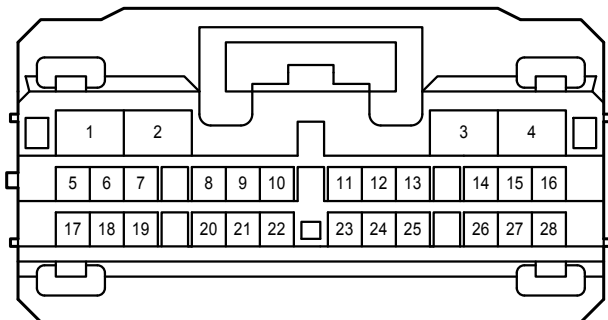

L 10  
White

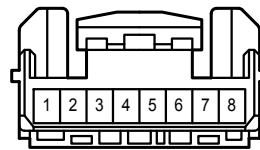

L 11  
White

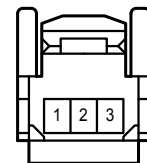

L 27  
White

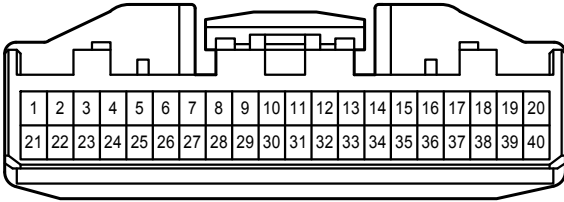

L 43  
Black

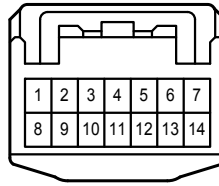

L 55  
Blue

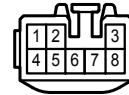

L 62  
White

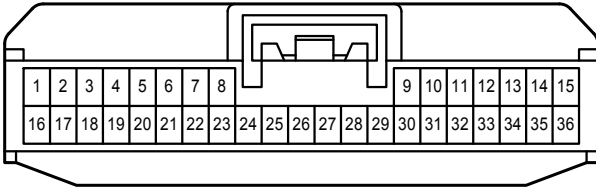

L 63  
White

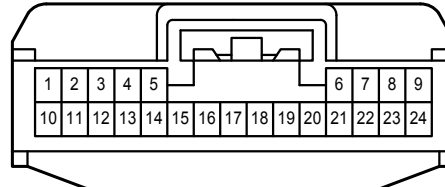

L 89  
Black

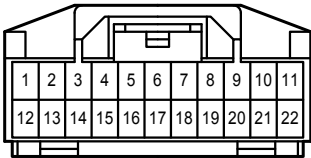

L 92  
White

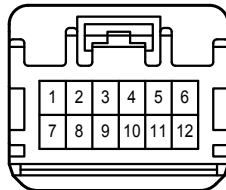

L 93  
White

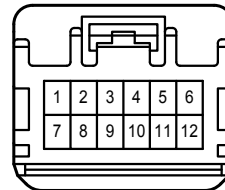

L 94  
White

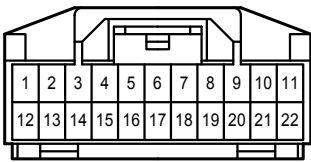

L 95  
White

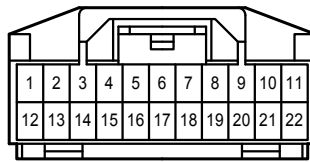

L101  
Black

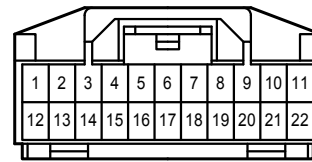

N 8  
White

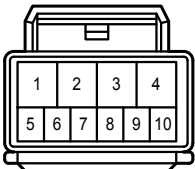

O 8  
White

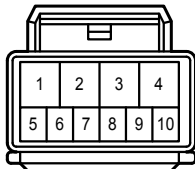

P 1  
White



Q 1  
White

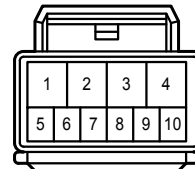

R 6  
Black



R 10  
White

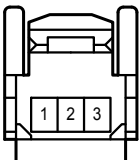

R 13  
Black



R 18  
White

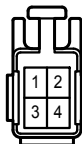

R 19  
White



R 28  
White

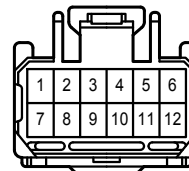

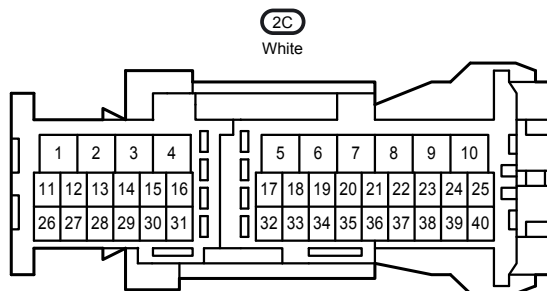
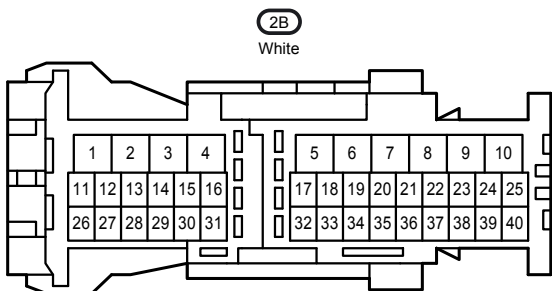
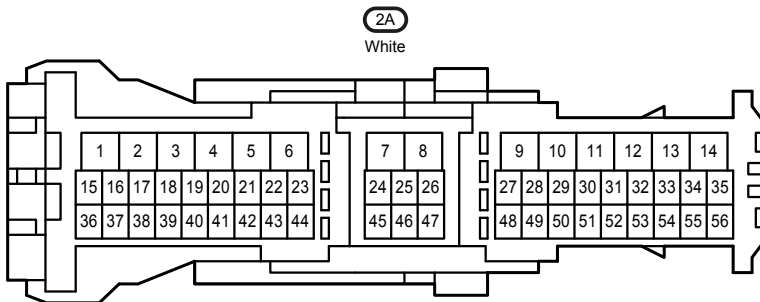
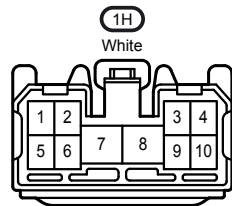
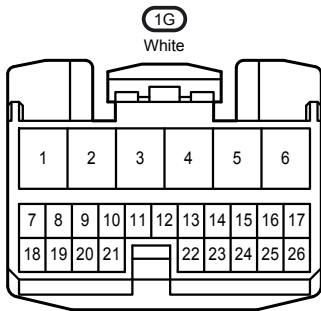
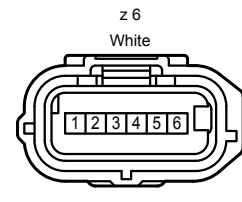
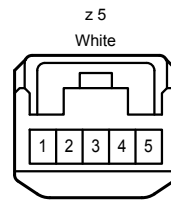
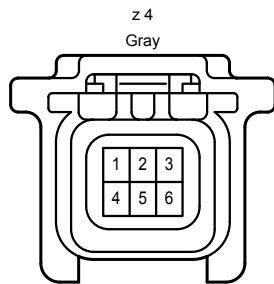
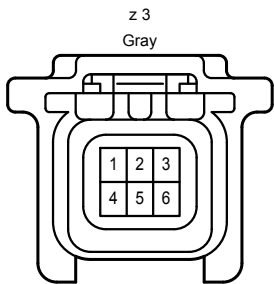
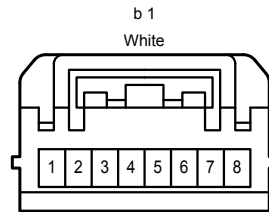
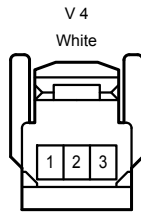
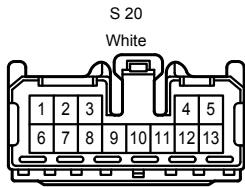
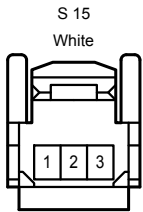
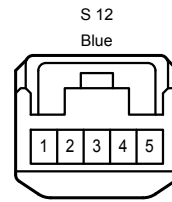
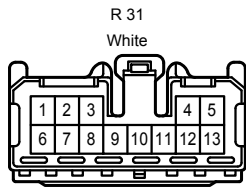
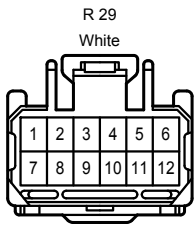

2D  
White

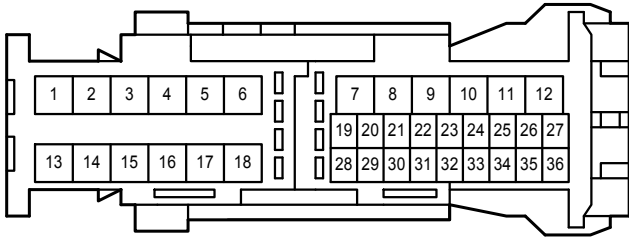

3A  
White

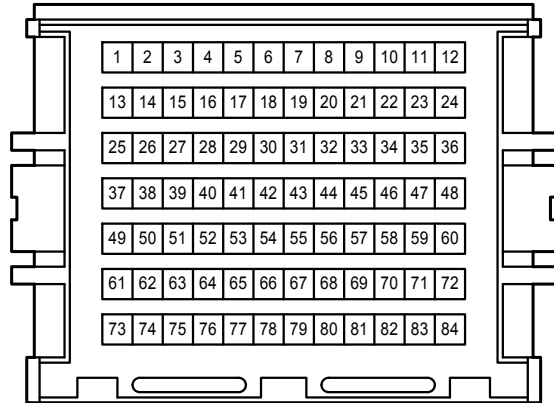

3B  
White

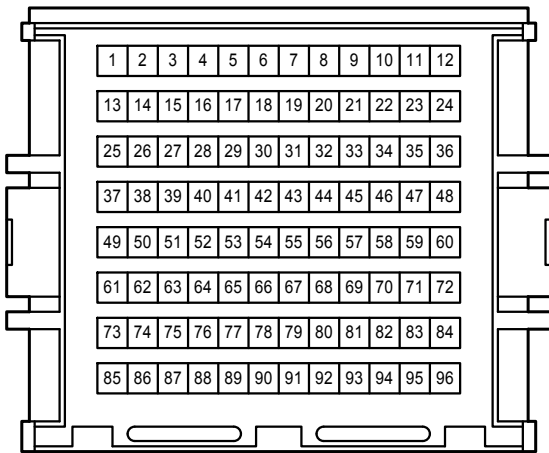

AL1  
Blue

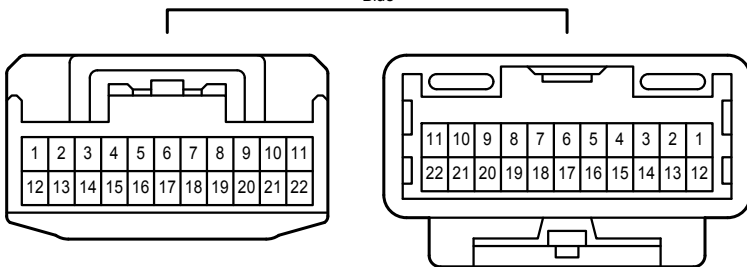

AL2  
Gray

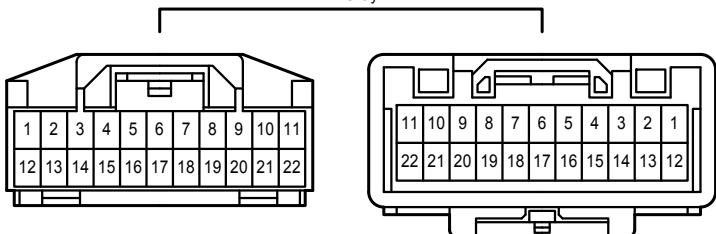



AL3  
White

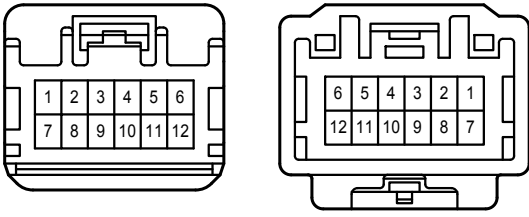

AL8  
White

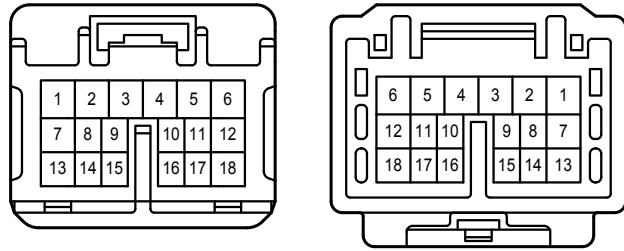

DA1  
White

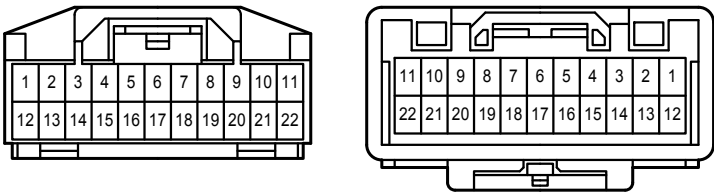

DA2  
White

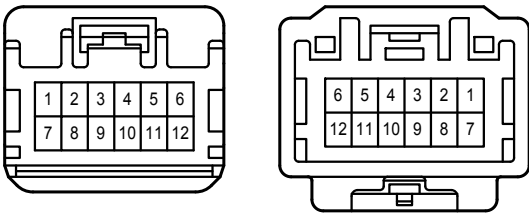

LR1  
White

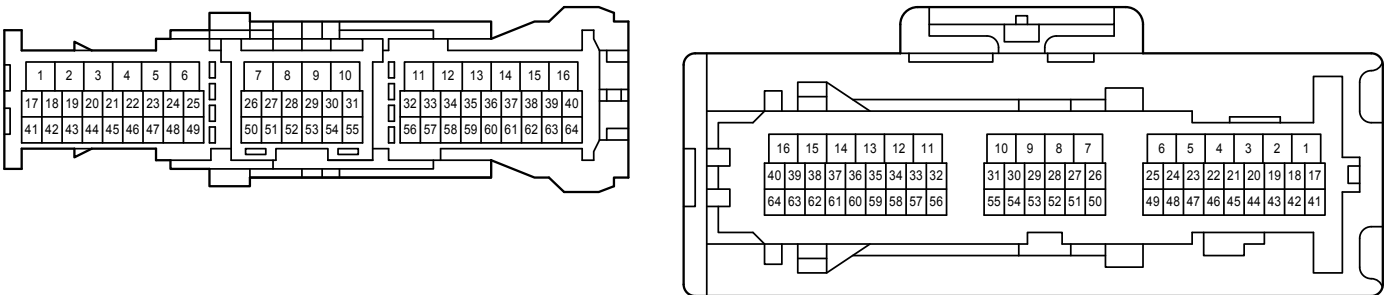

LR2  
Black

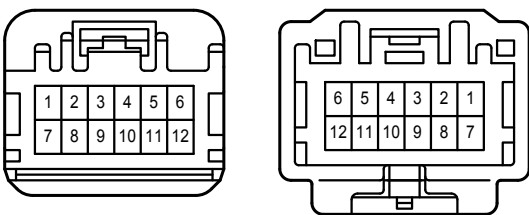

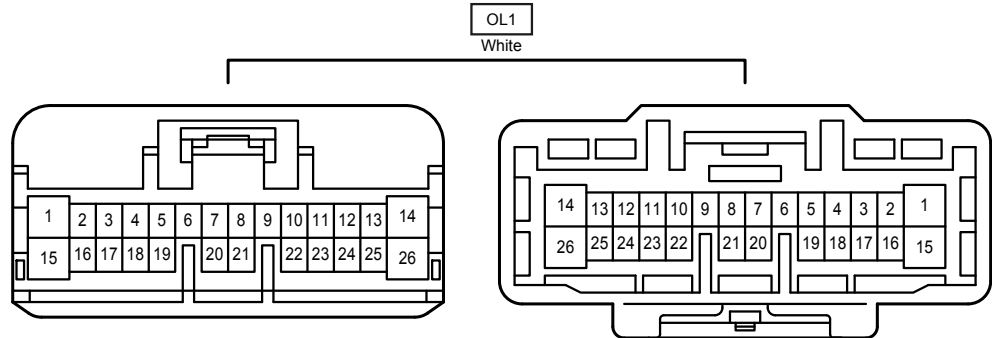
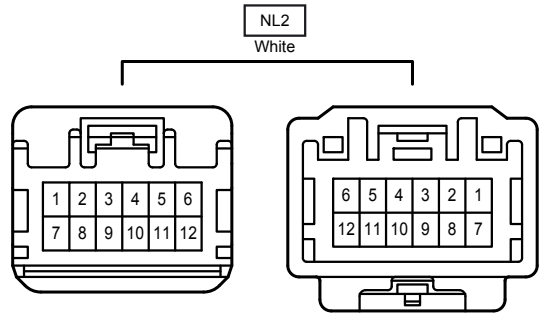
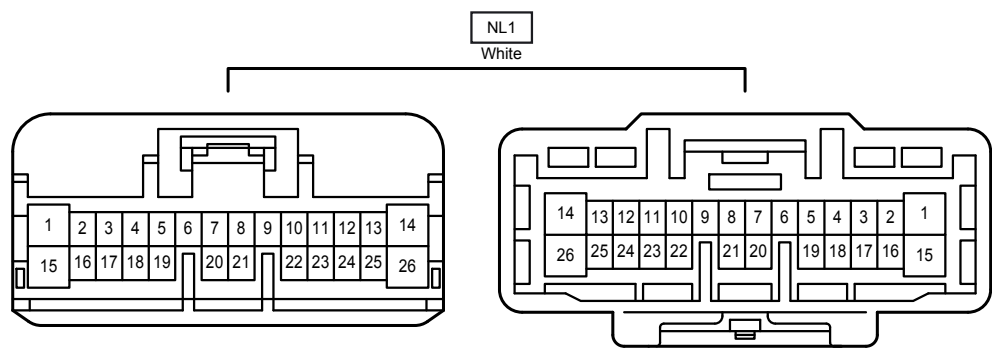
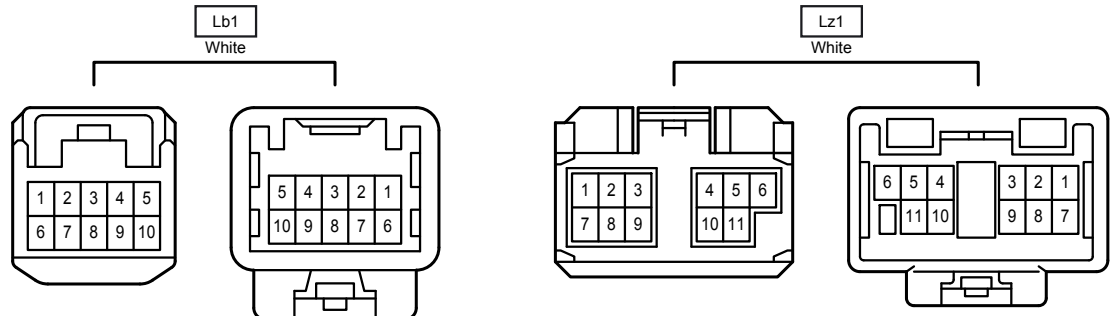
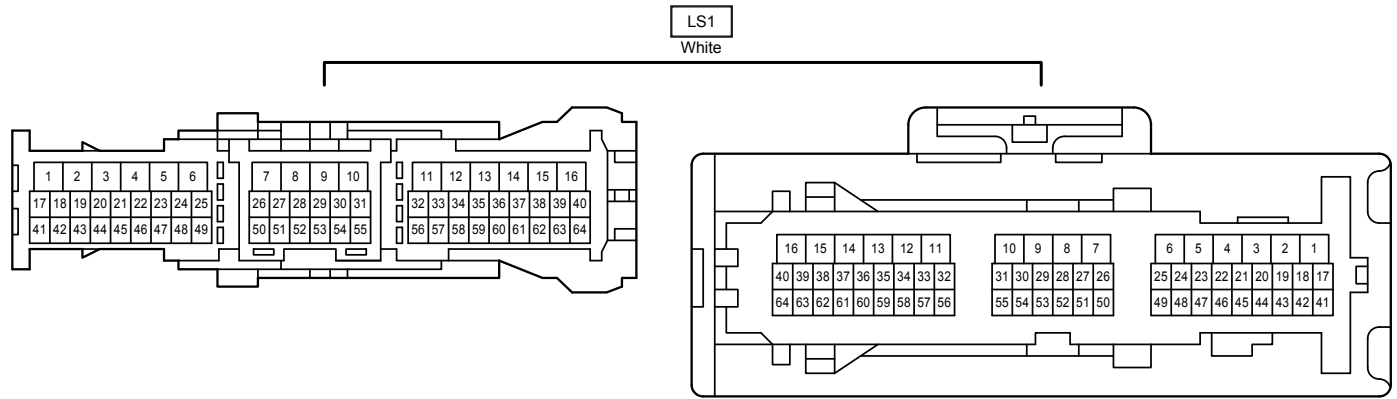

OL2  
White

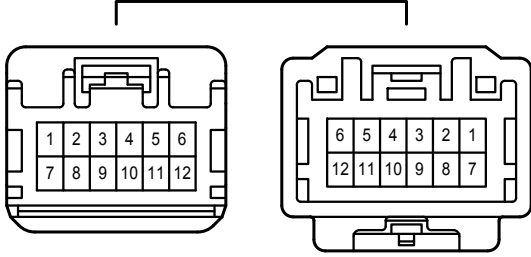

PS1  
White

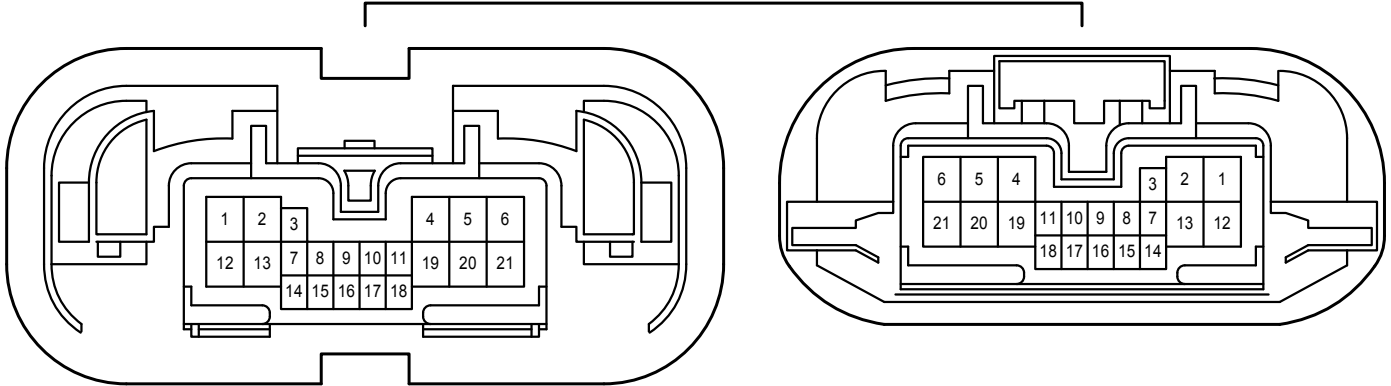

QR1  
White

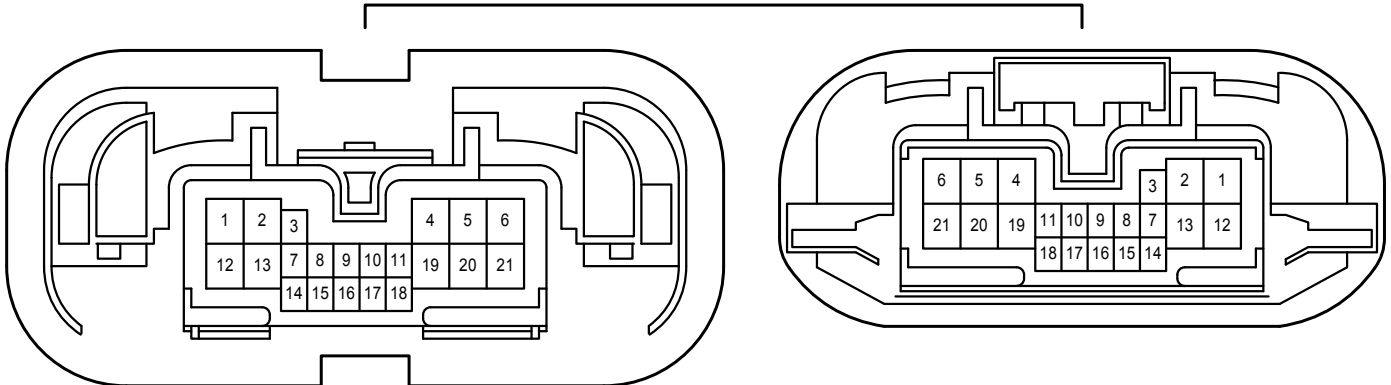

VR1  
White

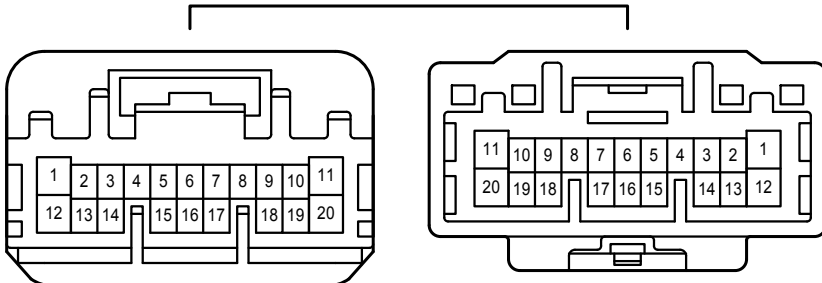

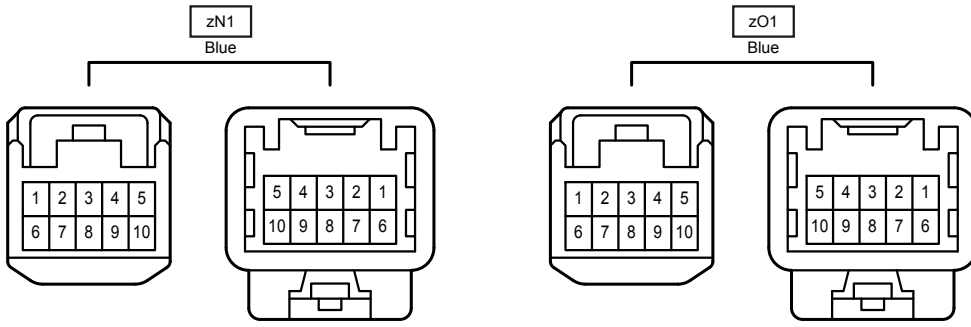



# Ignition

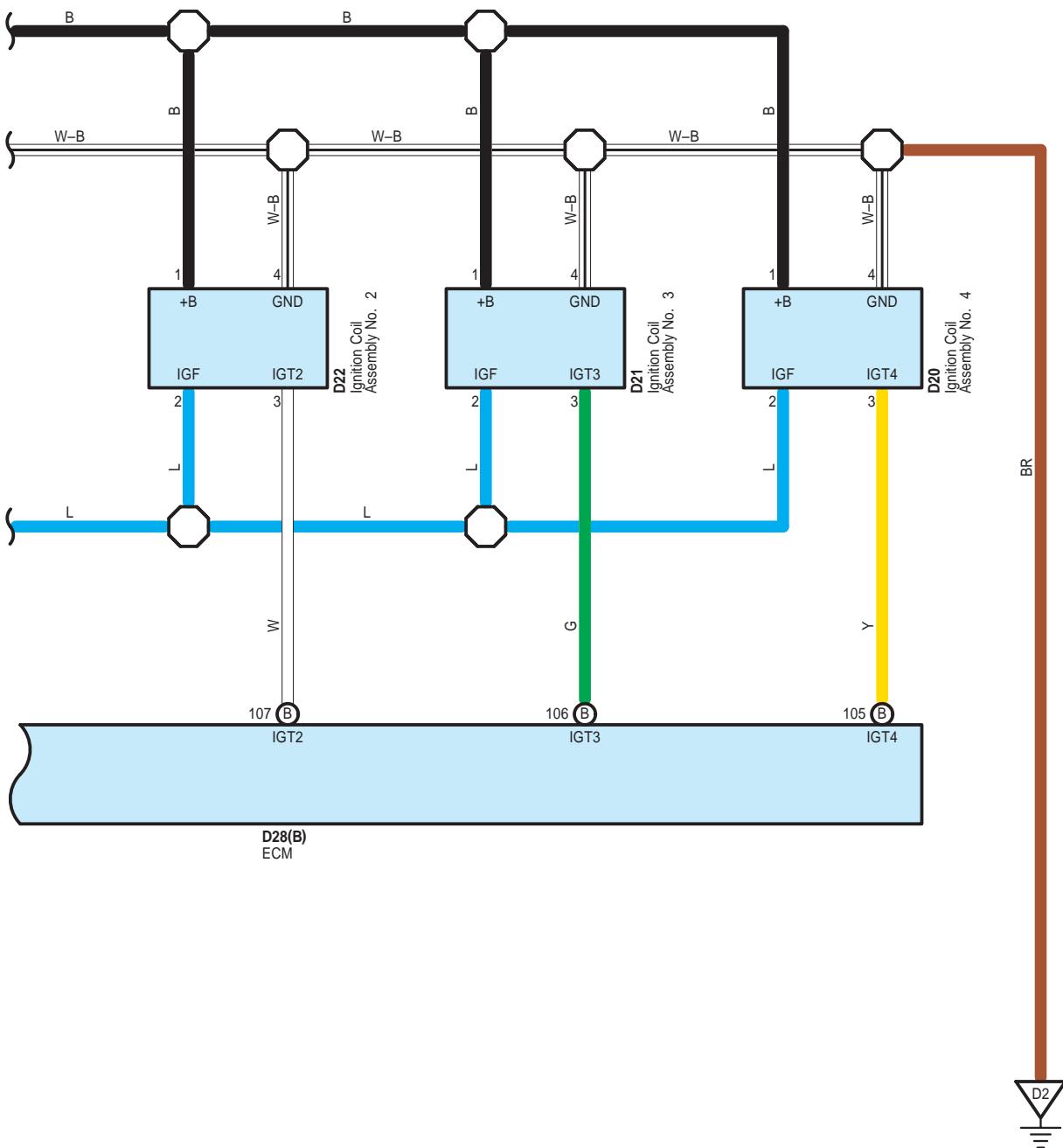



# Illumination , Taillight

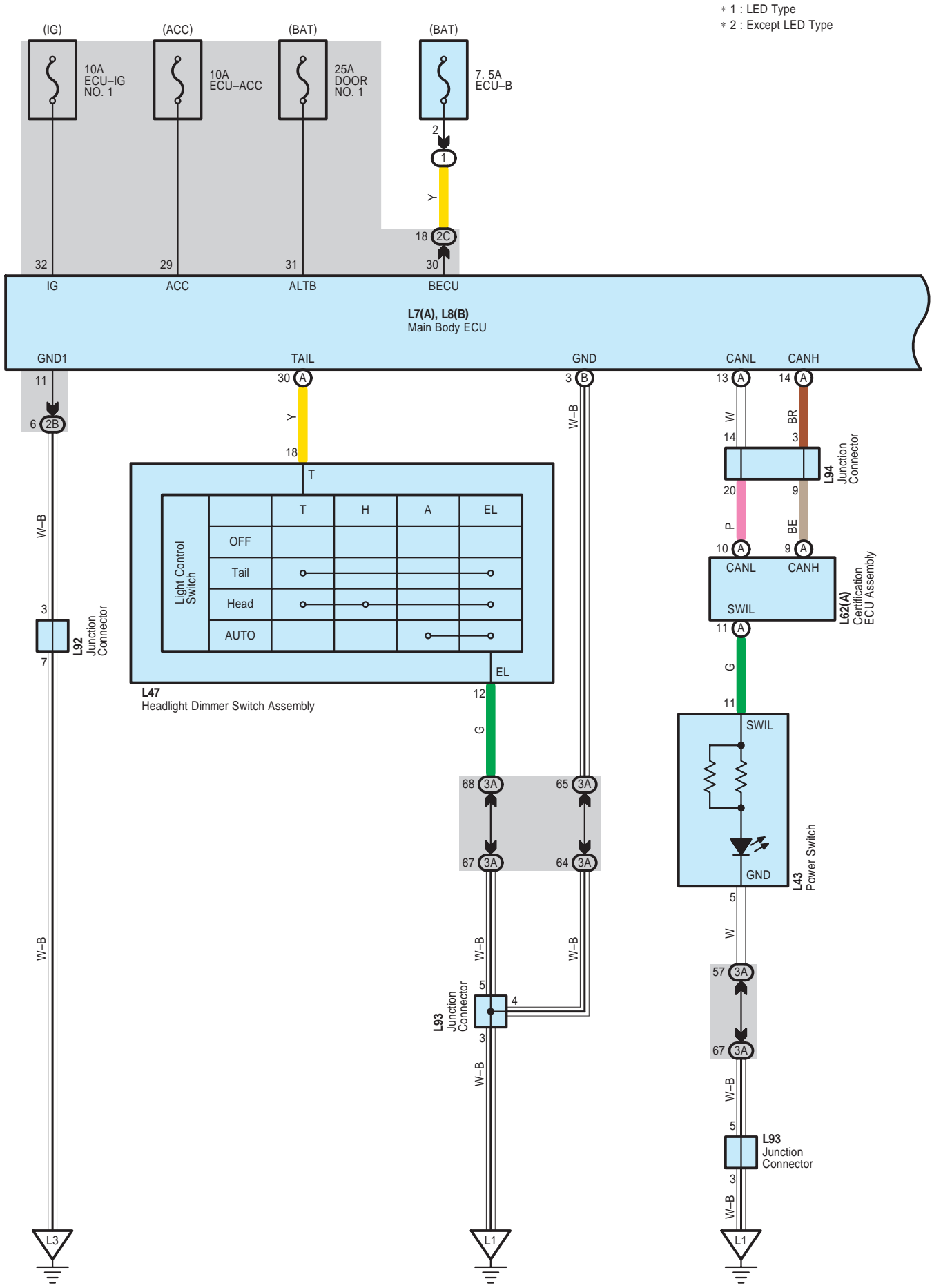



illumination , Taillight

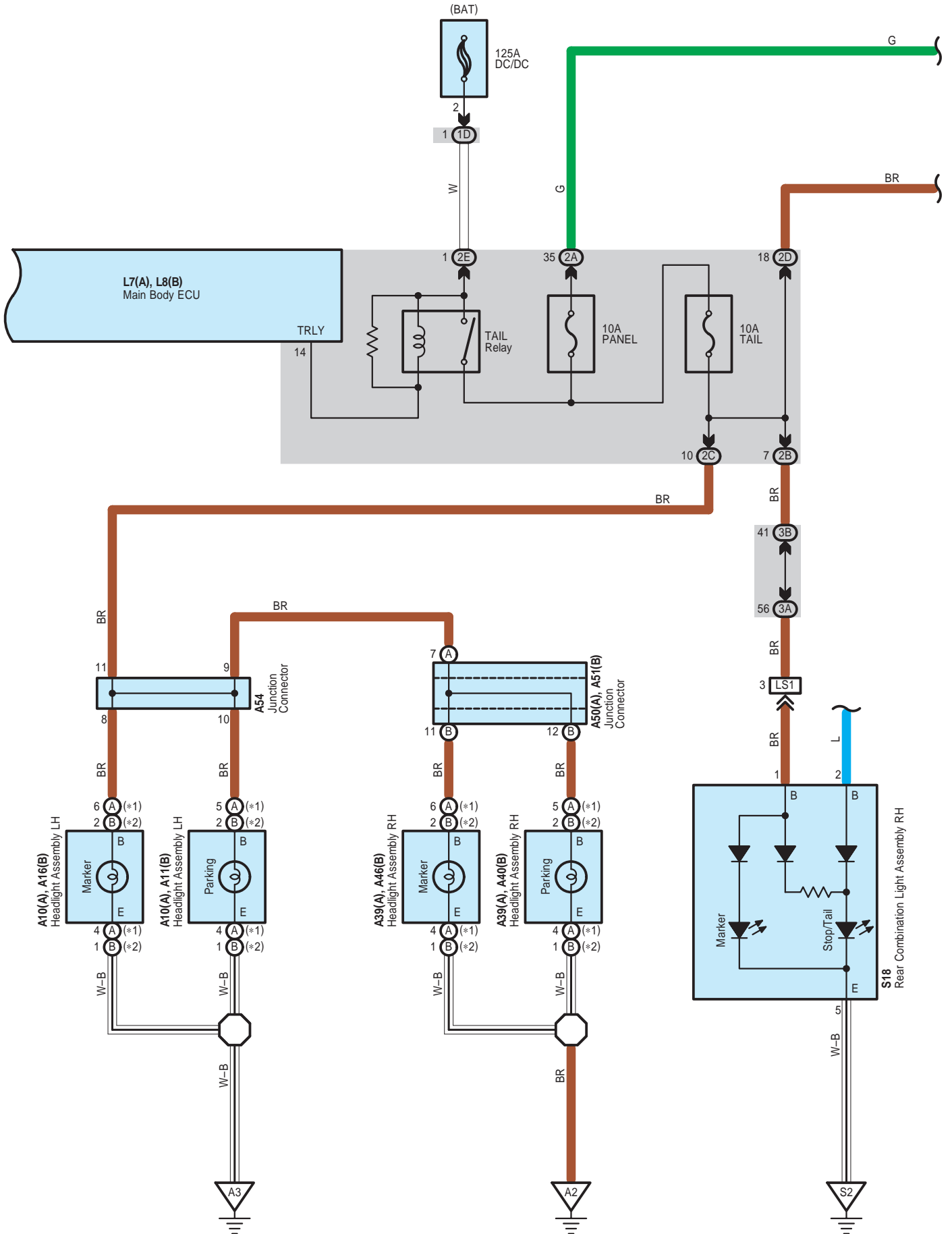

illumination , Taillight

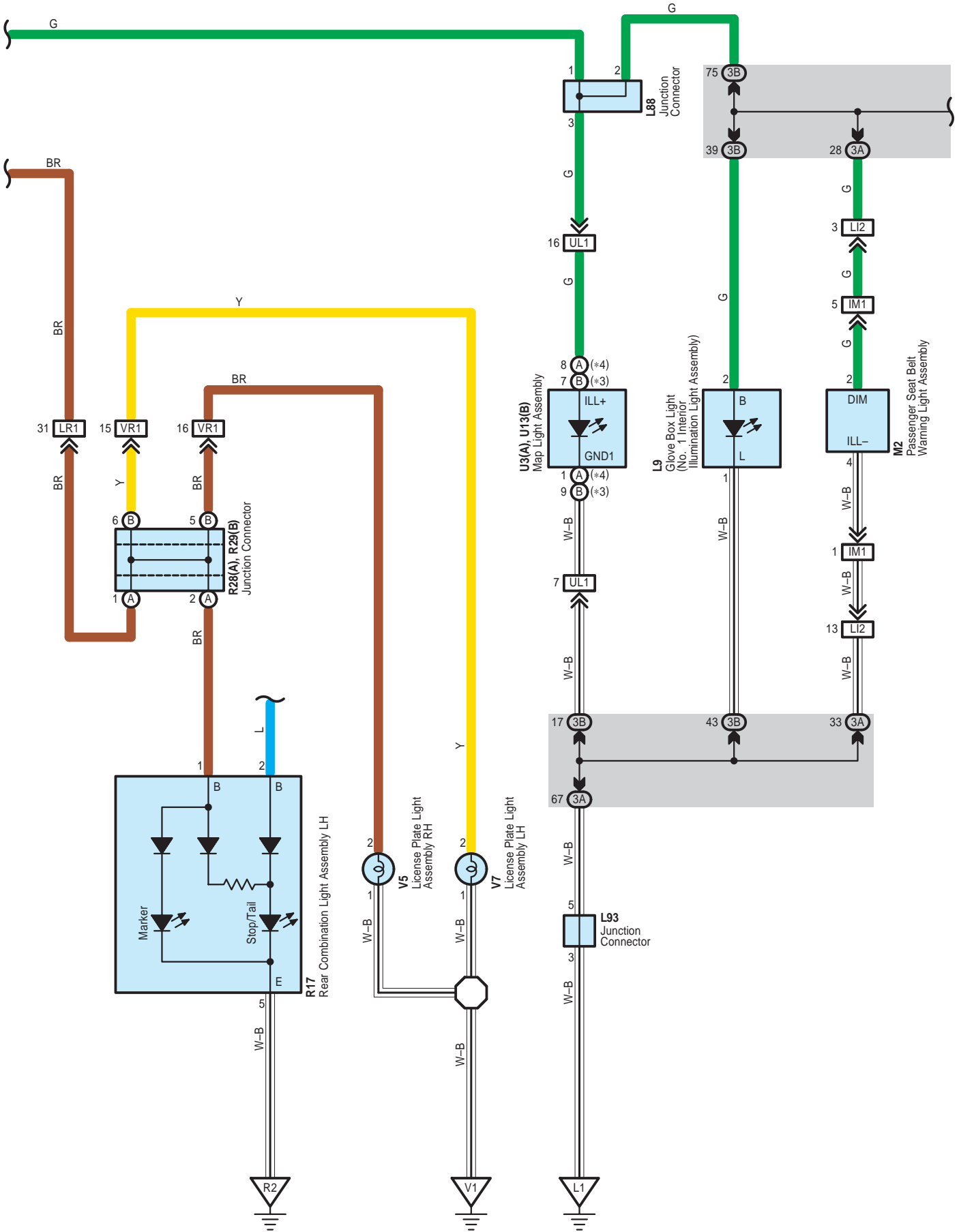



illumination , Taillight

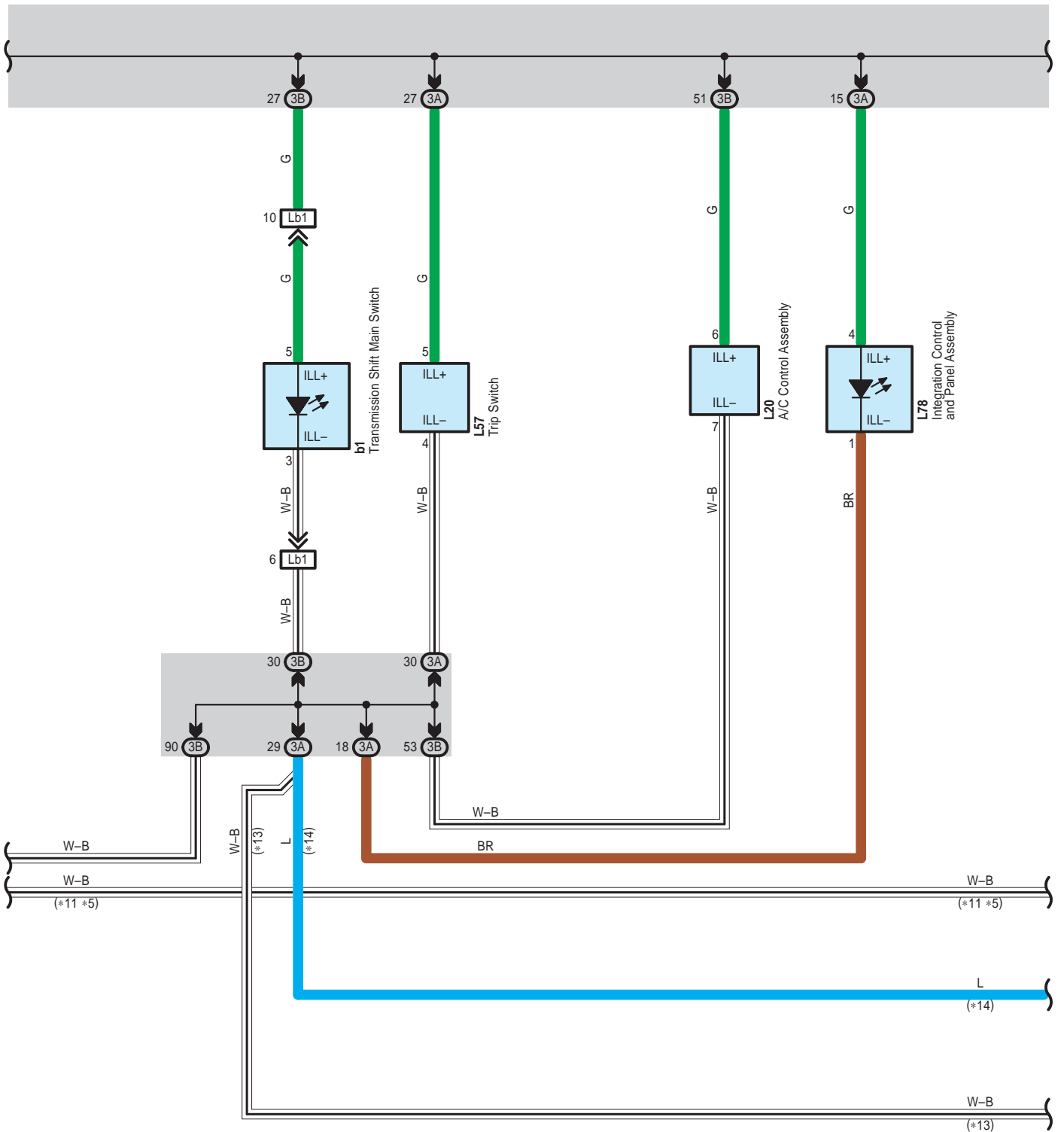



# Illumination , Taillight

- \* 5 : w/ Stereo Component Amplifier
- \* 6 : w/o Stereo Component Amplifier
- \* 11 : w/o Navigation System
- \* 13 : Korea
- \* 14 : Except Korea

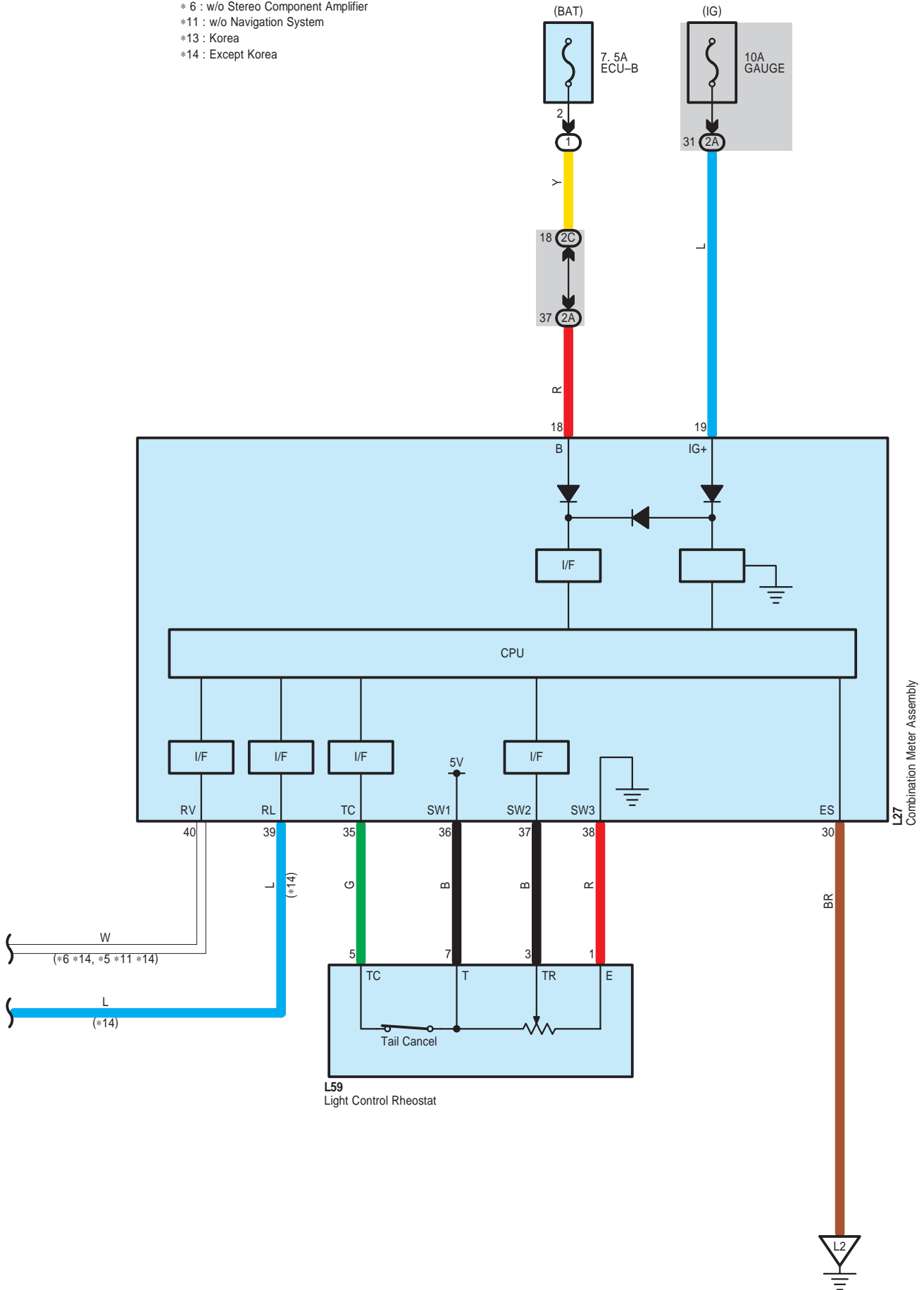

illumination , Taillight

A 10  
Gray



A 11  
Gray



A 16  
Black

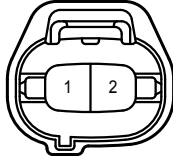

A 39  
Gray



A 40  
Gray

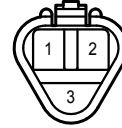

A 46  
Black

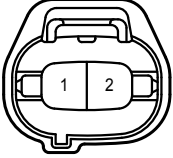

A 50  
White

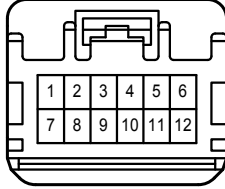

A 51  
White

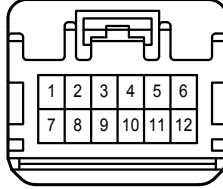

A 54  
Black

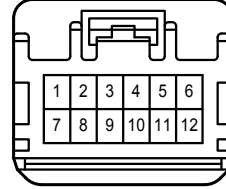

L 7  
White

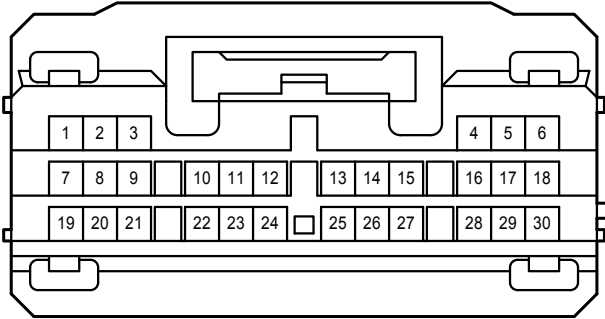

L 8  
White

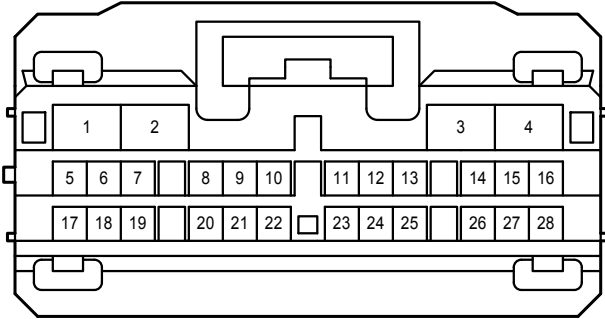

L 9  
Black



L 19  
White

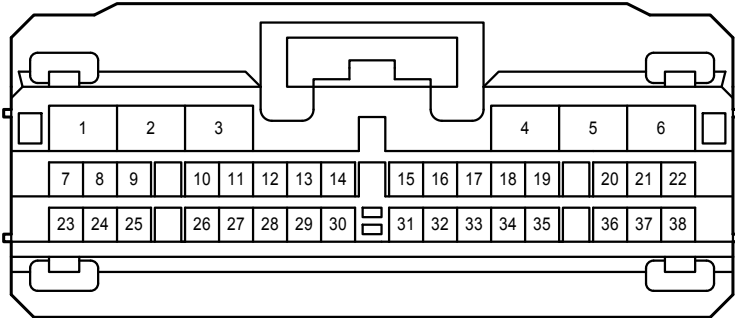

L 20  
Black



Illumination , Taillight

L 26  
Black

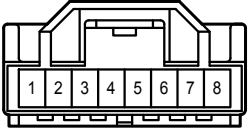

L 27  
White

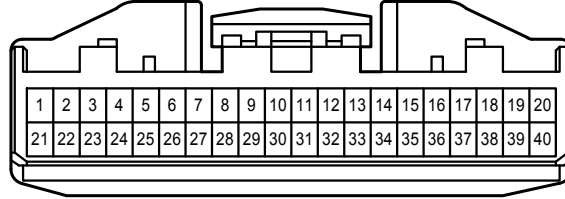

L 34  
White

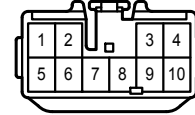

L 35  
White



L 40  
White

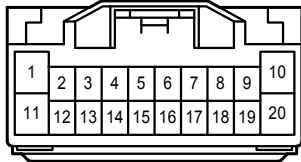

L 43  
Black

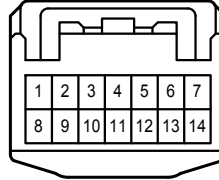

L 47  
White

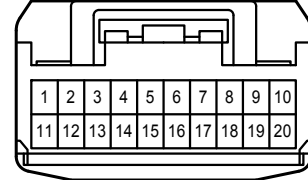

L 52  
Black



L 56  
Black

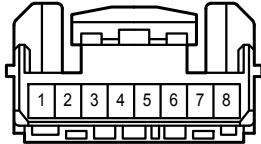

L 57  
Black

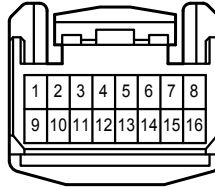

L 58  
Gray

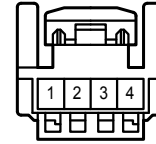

L 59  
White

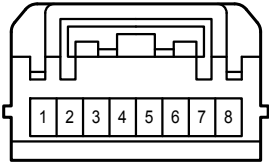

L 62  
White

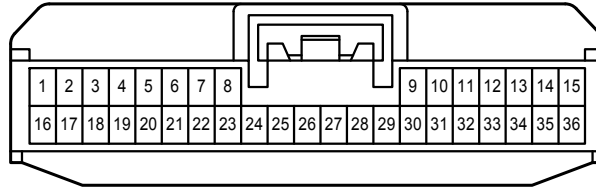

L 66  
White

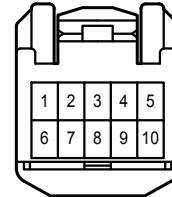

L 78  
Black

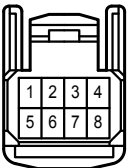

L 85  
White

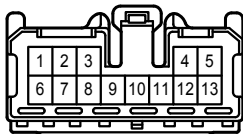

L 88  
Black

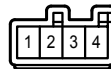

L 89  
Black

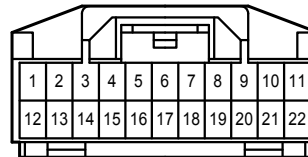

L 92  
White

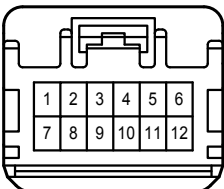

L 93  
White

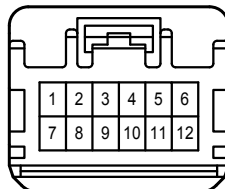

L 94  
White

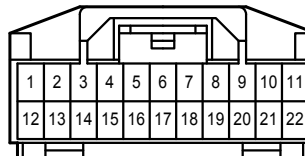

M 2  
White

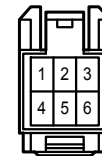



illumination , Taillight

R 17

White

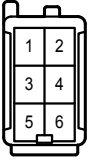

R 28

White

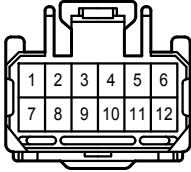

R 29

White

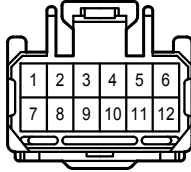

S 18

White

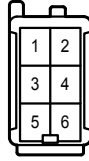

U 3

White

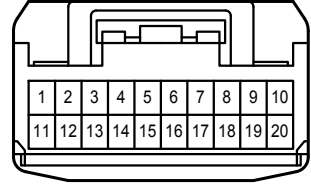

U 13

White

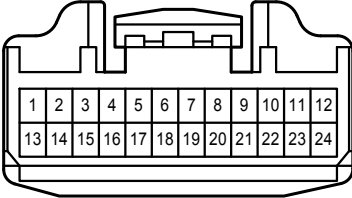

V 5

Gray



V 7

Gray



b 1

White

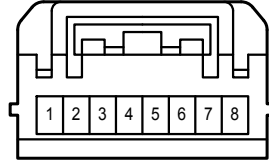

z 9

Black

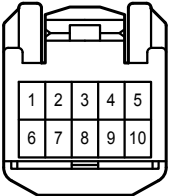

1D

Black

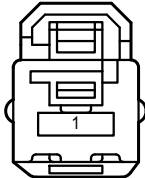

2A

White

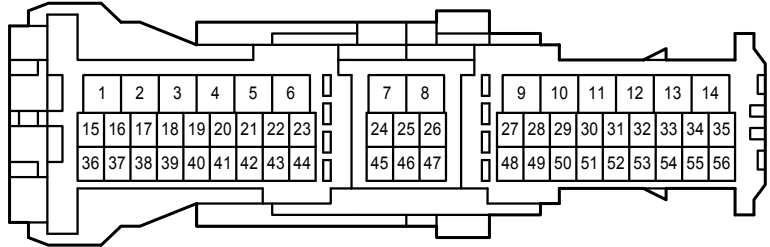

2B

White

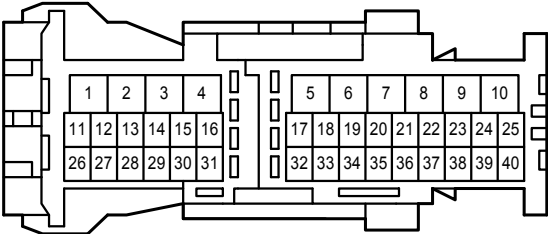

2C

White

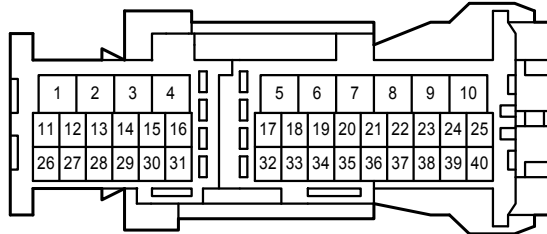

2D

White

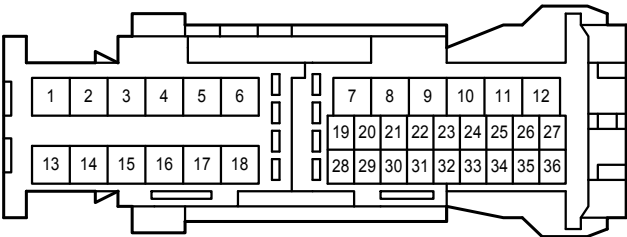

2E

White

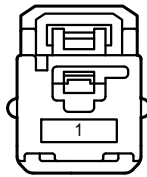

3A  
White

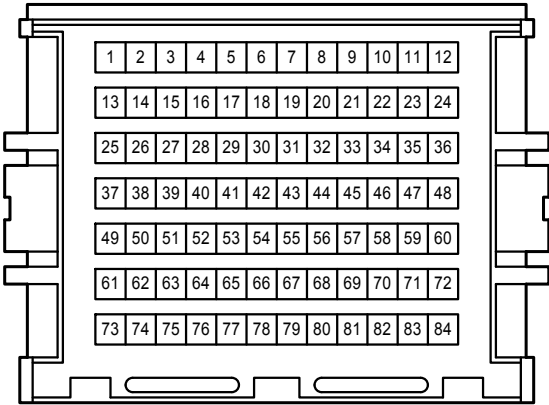

3B  
White

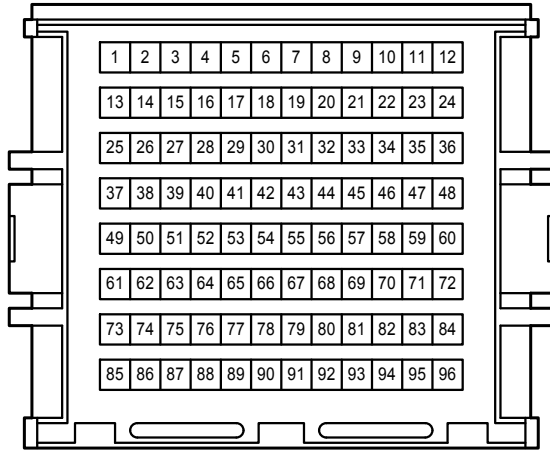

4A  
White

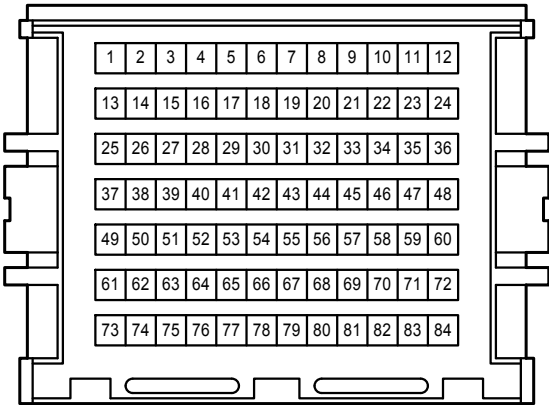

4B  
White

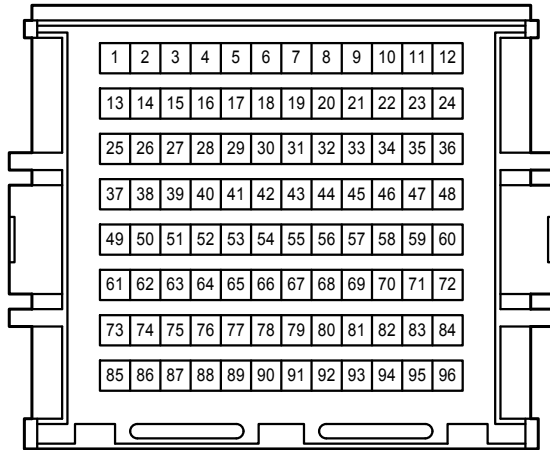

IM1  
White

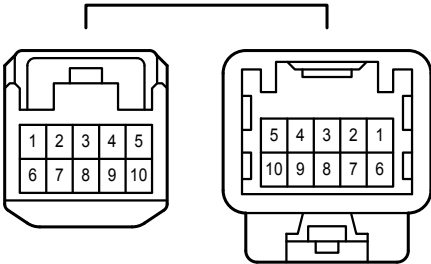

LI2  
White

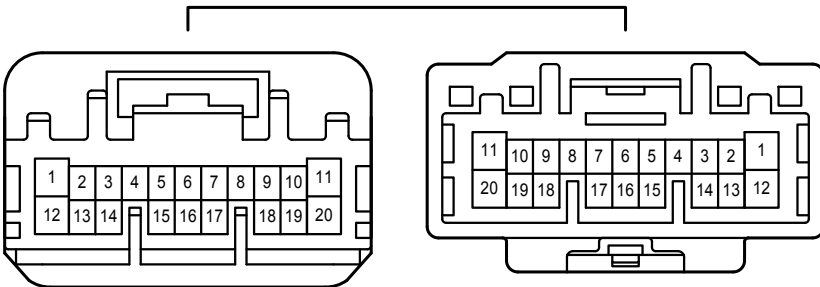

illumination , Taillight

LR1  
White

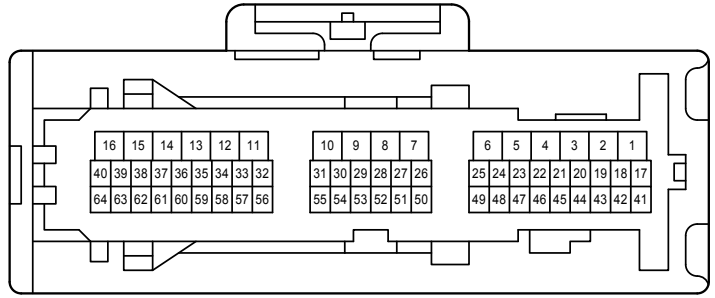
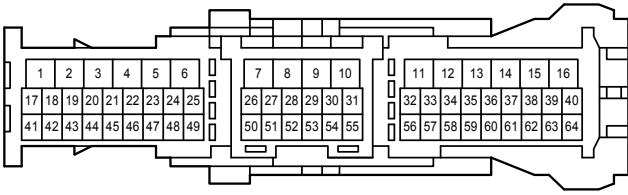

LS1  
White

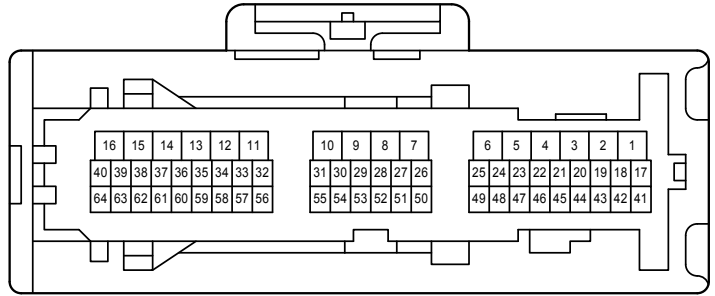
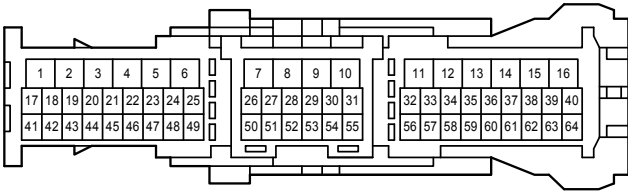

Lb1  
White

UL1  
Gray

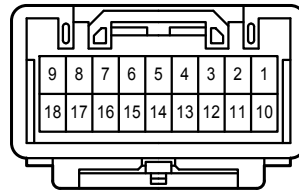
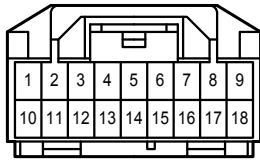
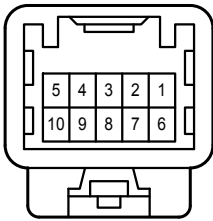
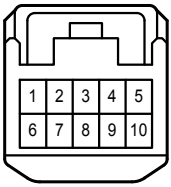

VR1  
White

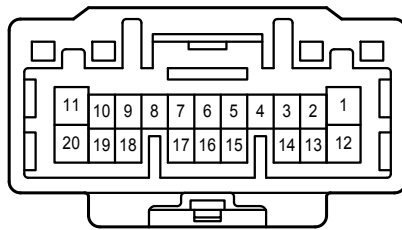
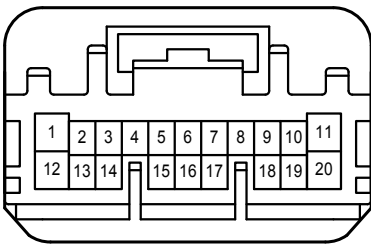

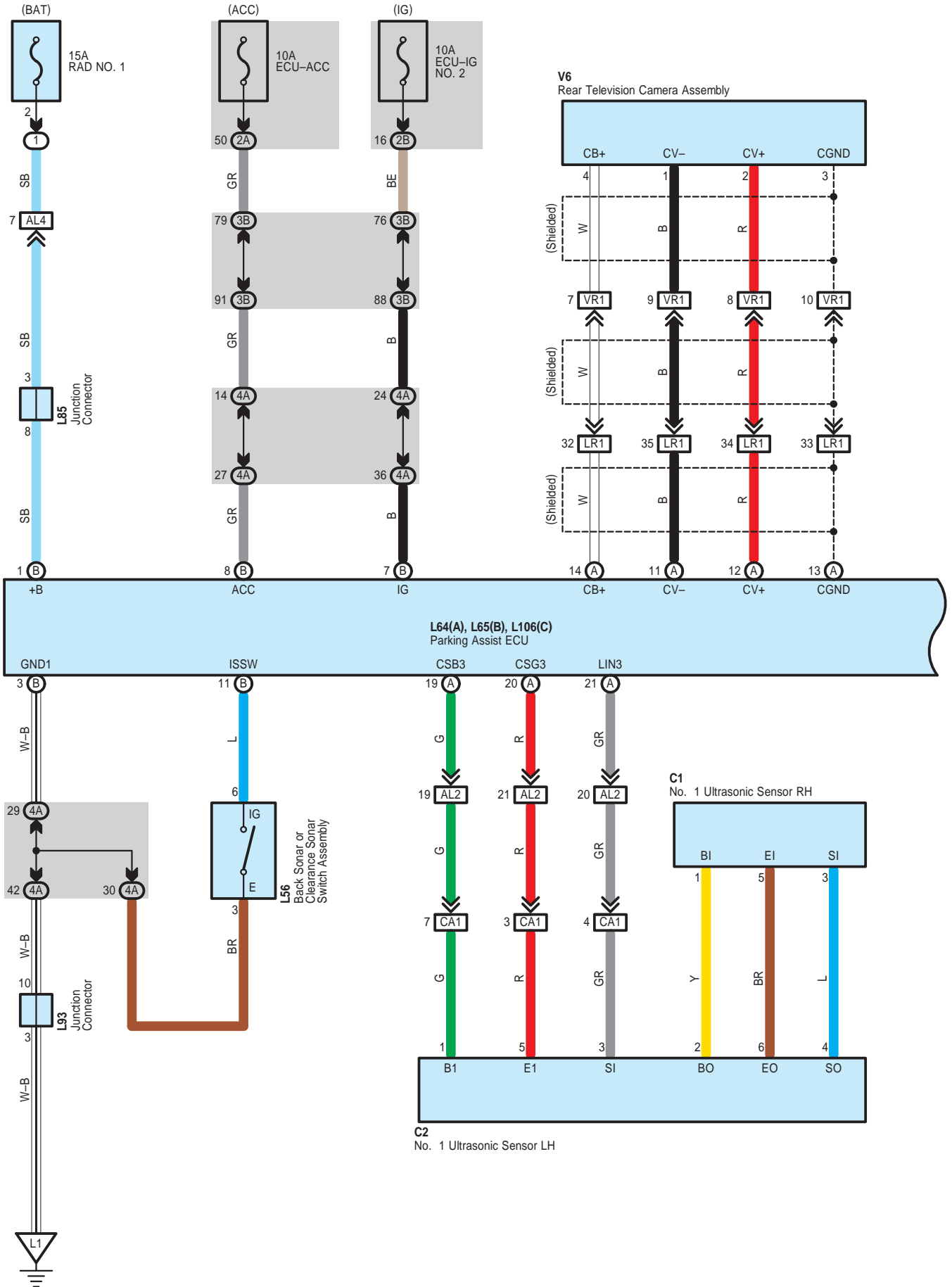

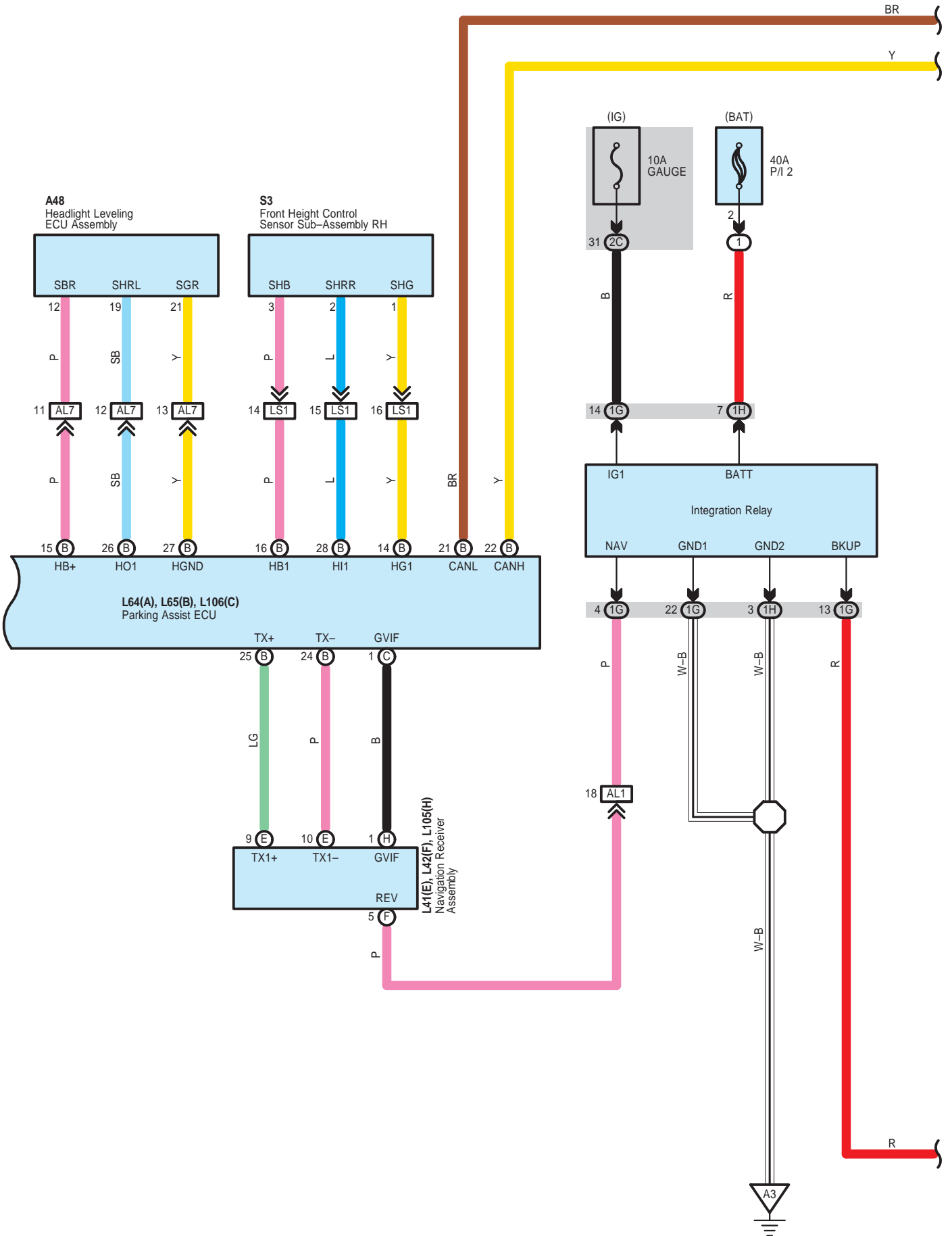

Intelligent Parking Assist , Parking Assist <Intuitive Parking Assist>

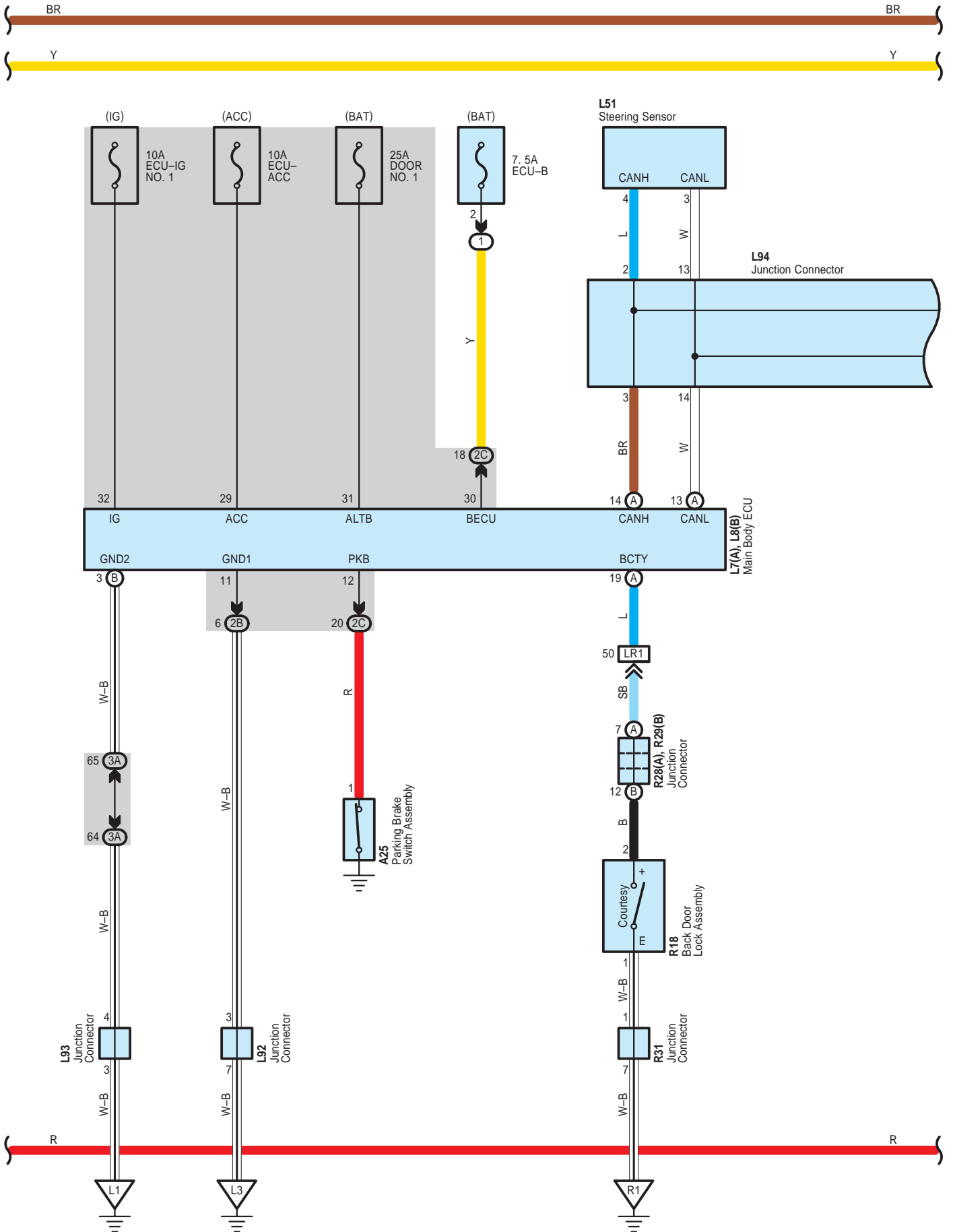



\* 1 : w/ Rotation Angle Sensor  
 \* 2 : w/o Rotation Angle Sensor

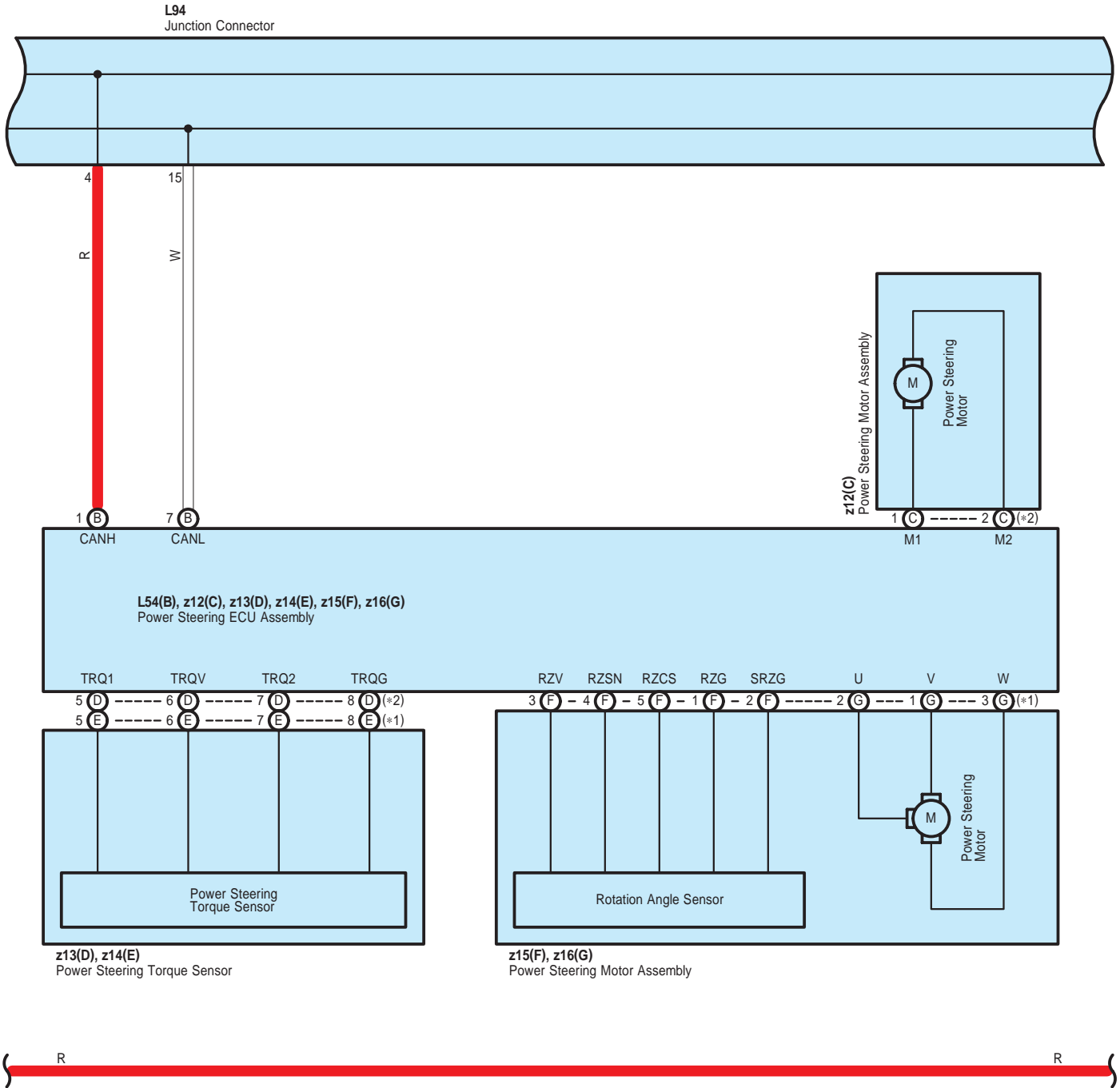

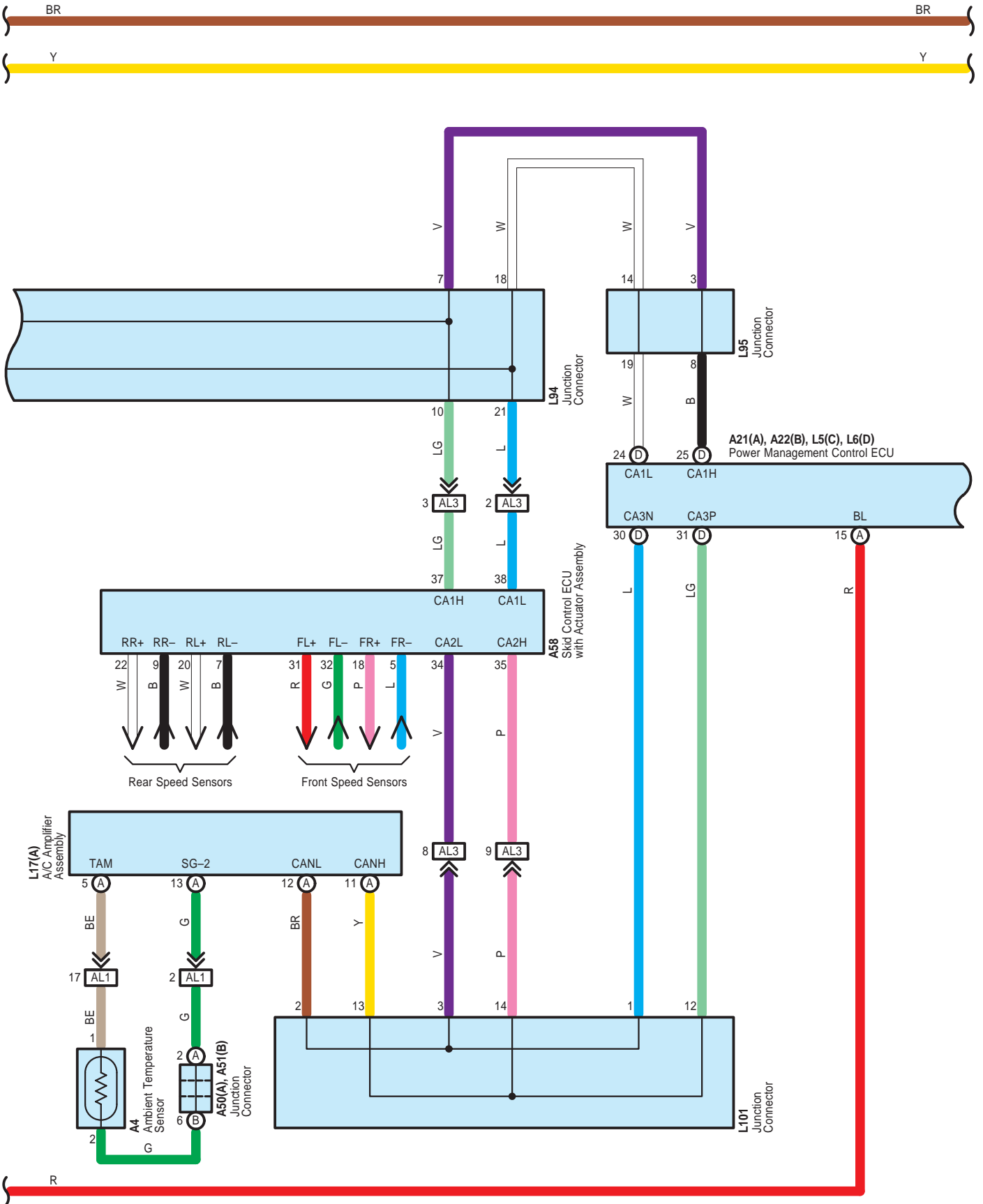



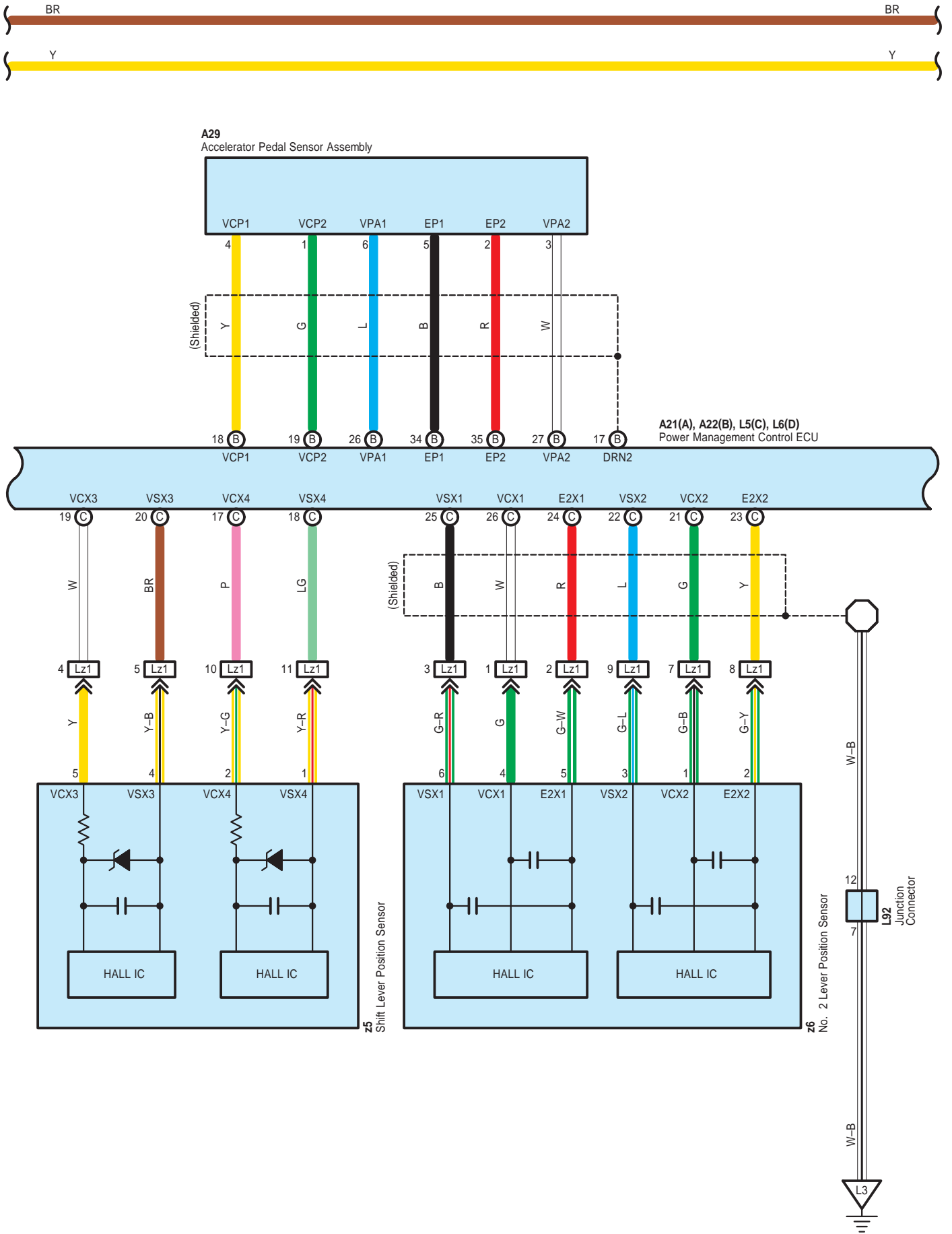

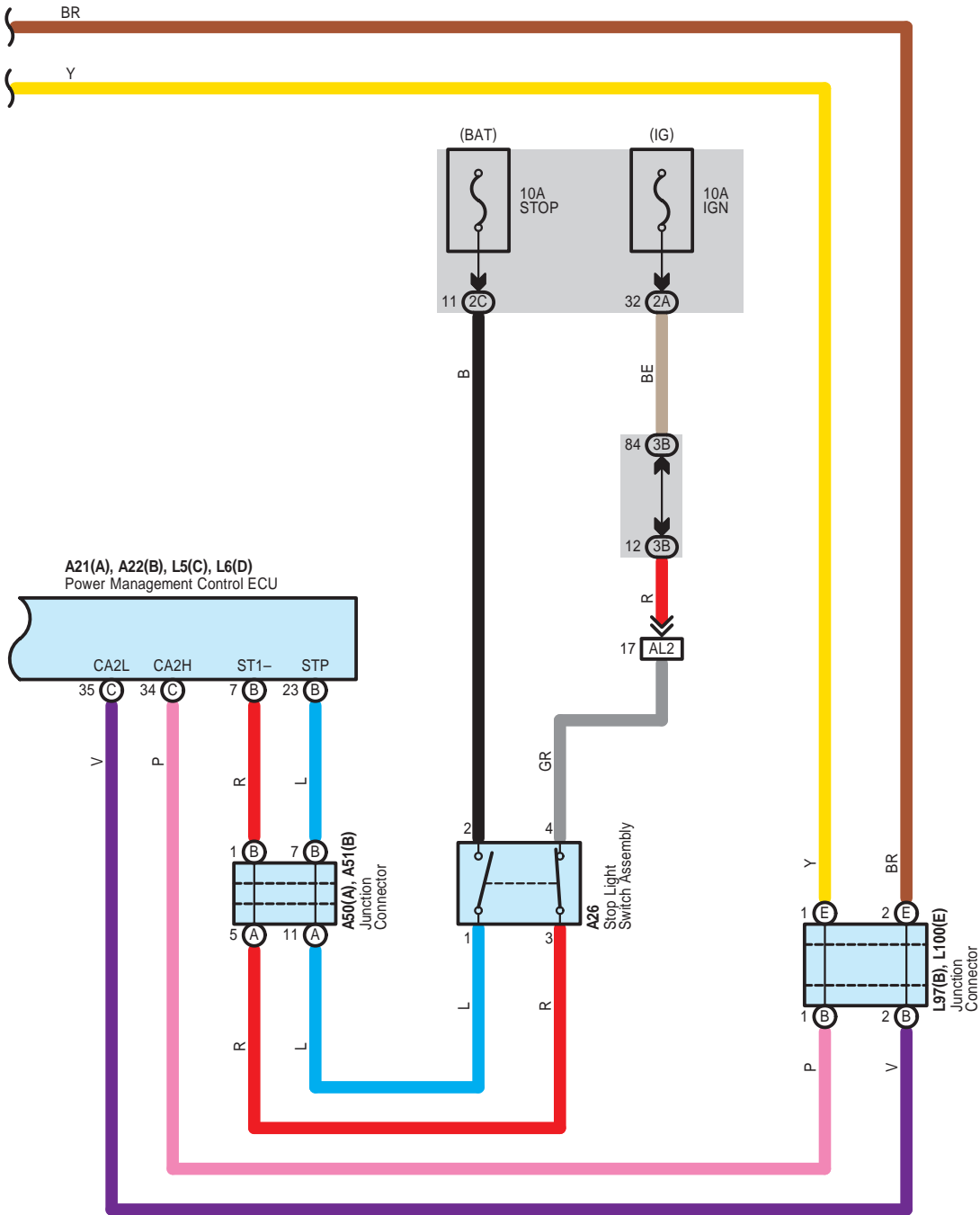

A 4

Black



A 21

Gray

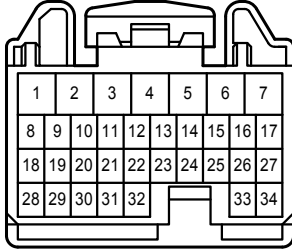

A 22

Gray

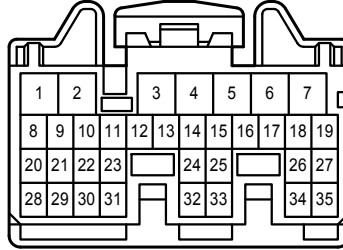

A 25

White



A 26

White

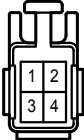

A 29

Black

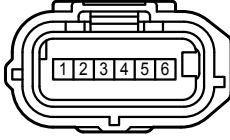

A 48

White

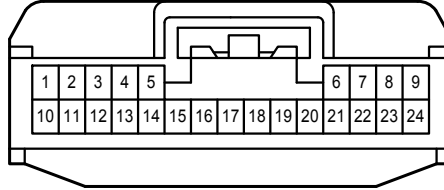

A 50

White

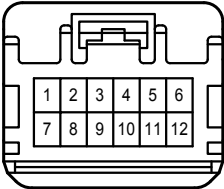

A 51

White

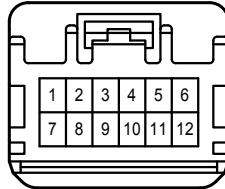

A 58

Gray

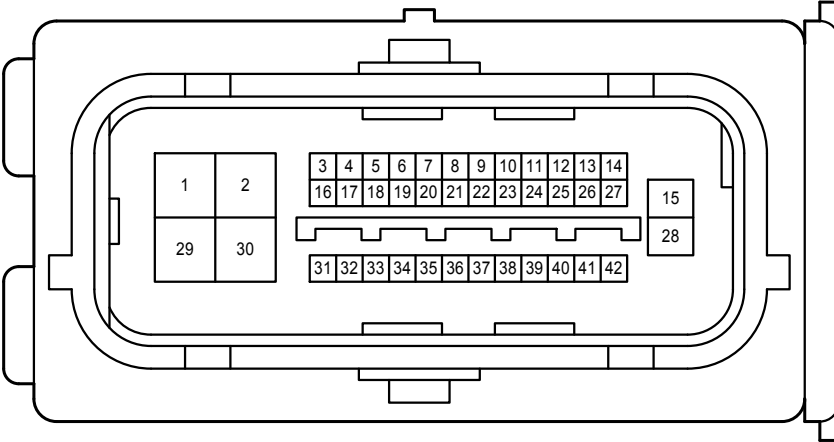

C 1

Black

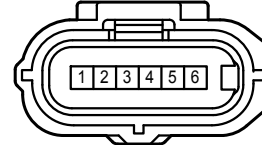

C 2

Black

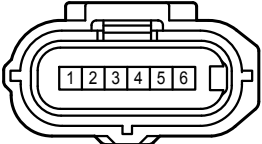

L 5

Gray

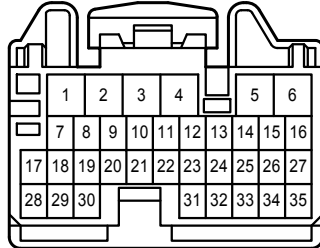

L 6

Gray

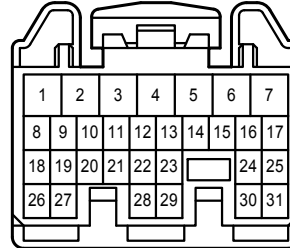

L 7  
White

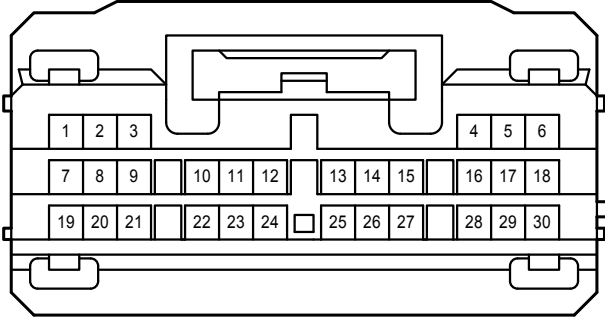

L 8  
White

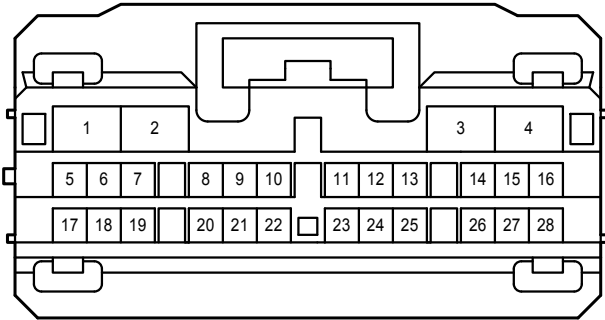

L 17  
White

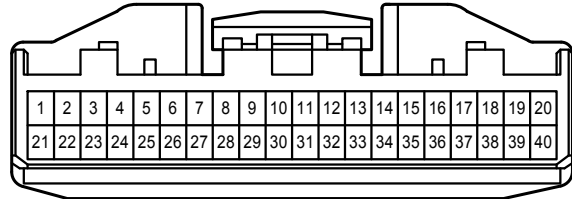

L 41  
White

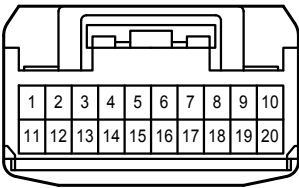

L 42  
Gray

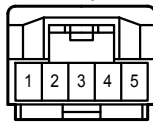

L 51  
White

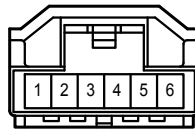

L 54  
White

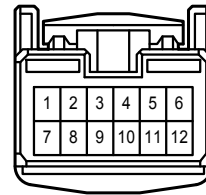

L 56  
Black

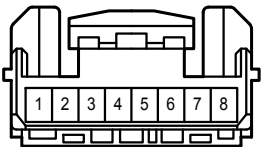

L 64  
White

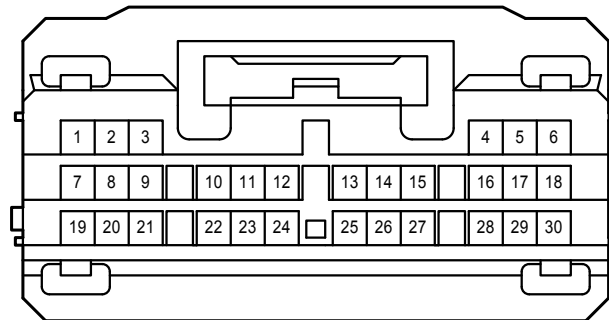

L 65  
White

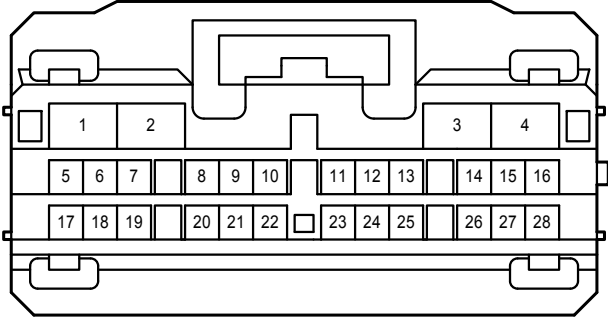

L 85  
White

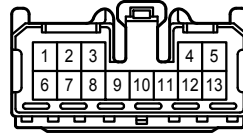

L 92  
White

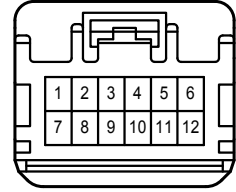

L 93  
White

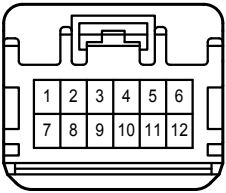

L 94  
White

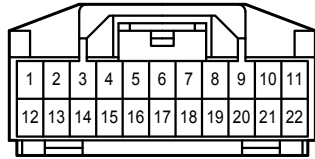

L 95  
White

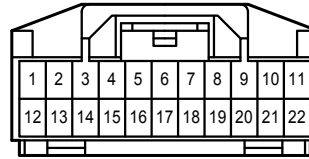

L 97  
White

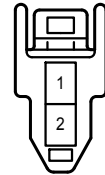

L 100  
White

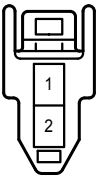

L 101  
Black

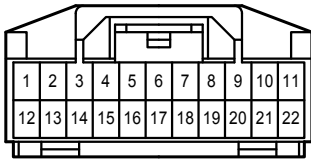

L 105  
Blue

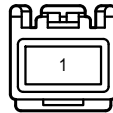

L 106  
White

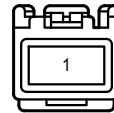

R 18  
White

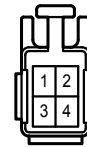

R 28  
White

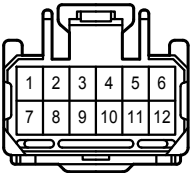

R 29  
White

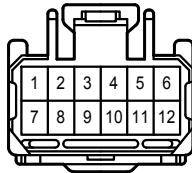

R 31  
White

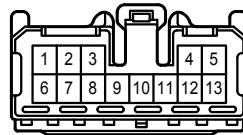

S 3  
Black

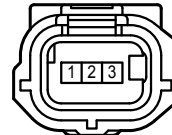

V 6  
Black

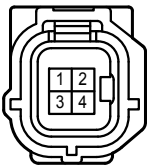

z 5  
White

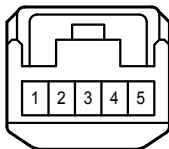

z 6  
White

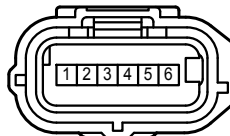

z 12  
White

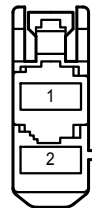

z 13  
Black

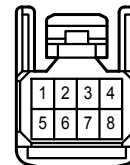

z 14  
White

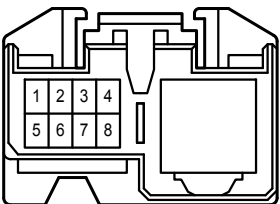

z 15  
White

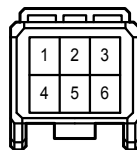

z 16  
White

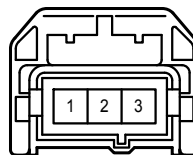

1G  
White

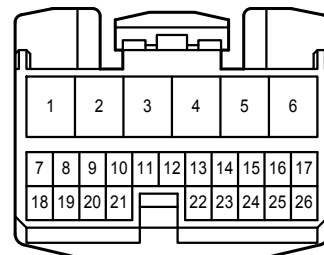

1H

White

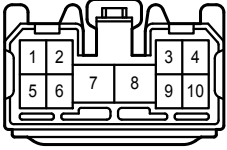

2A

White

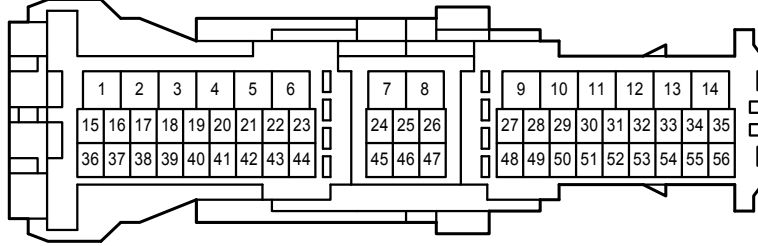

2B

White

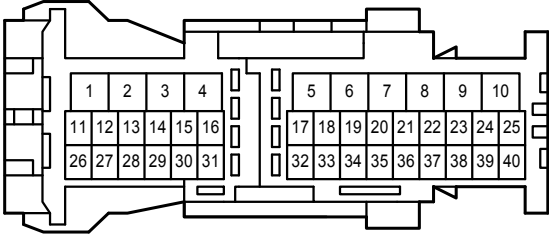

2C

White

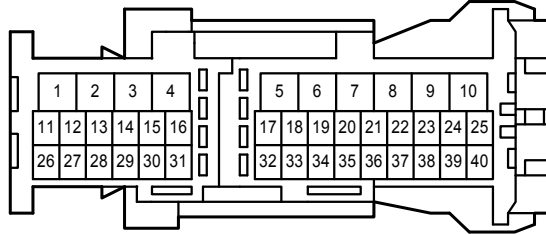

3A

White

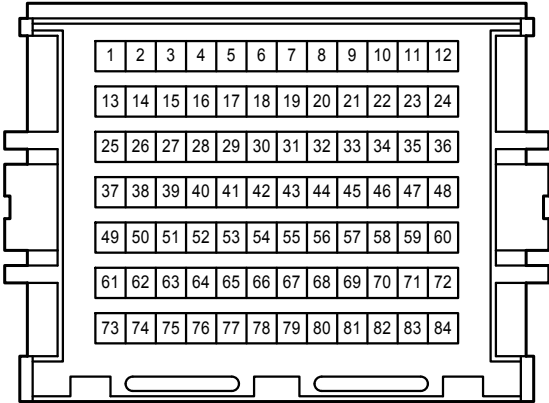

3B

White

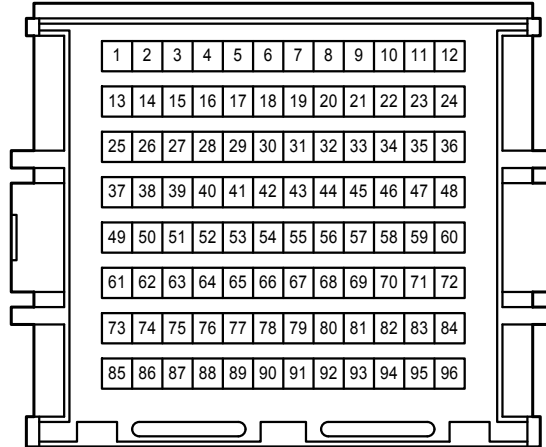

4A

White

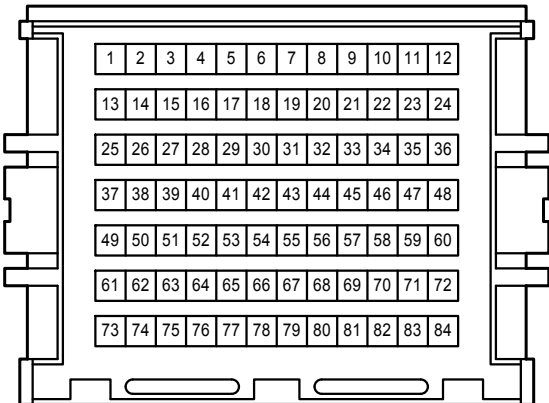

AL1  
Blue

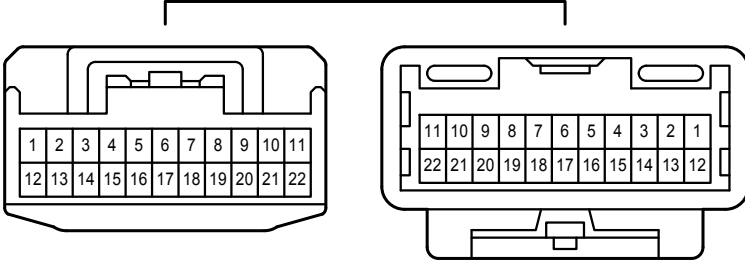

AL2  
Gray

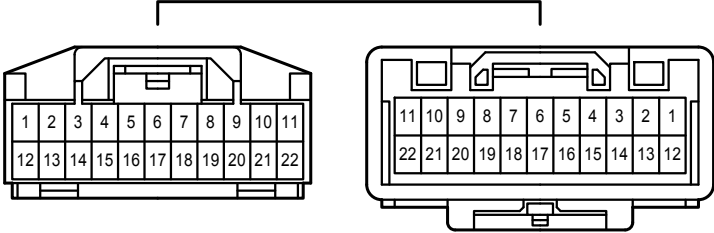

AL3  
White

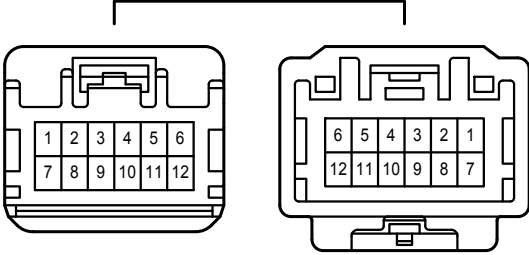

AL4  
Black

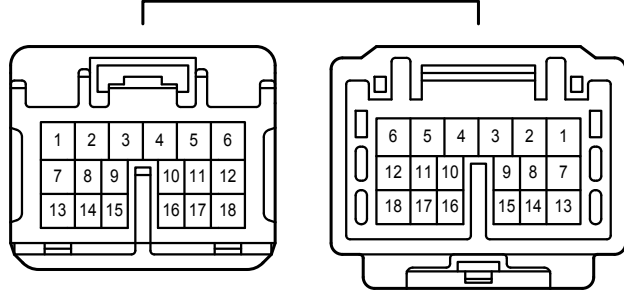

AL7  
Black

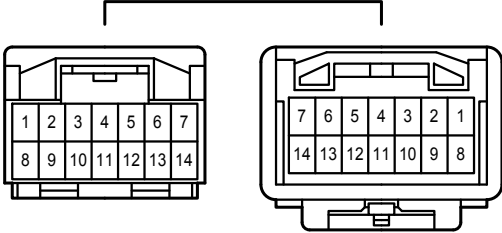

CA1  
Black

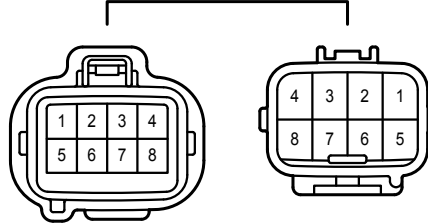

LR1  
White

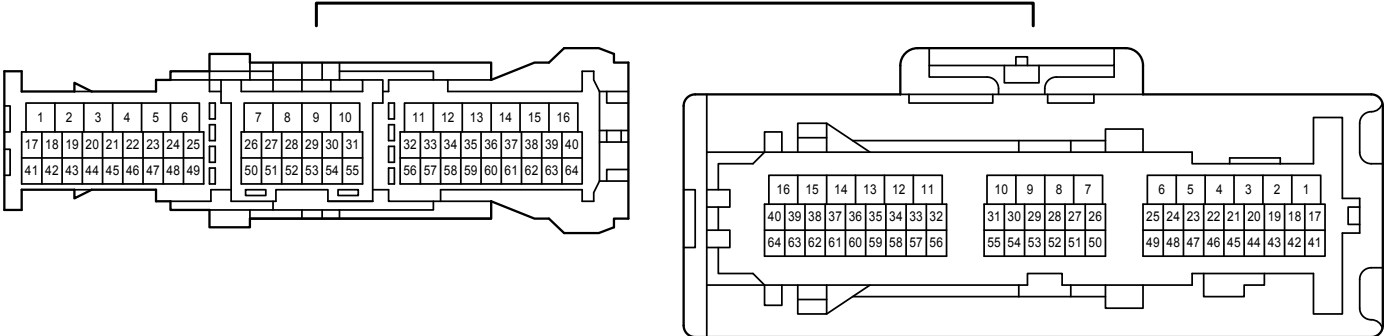

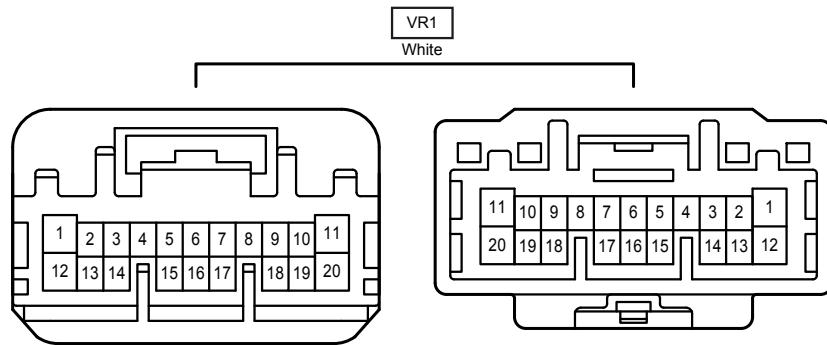
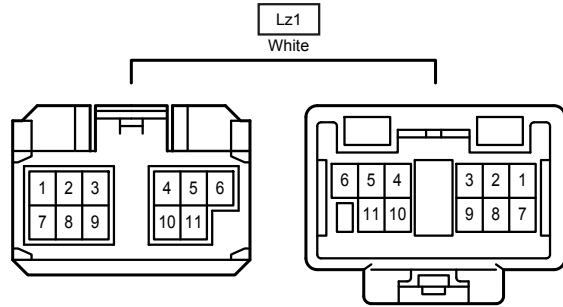
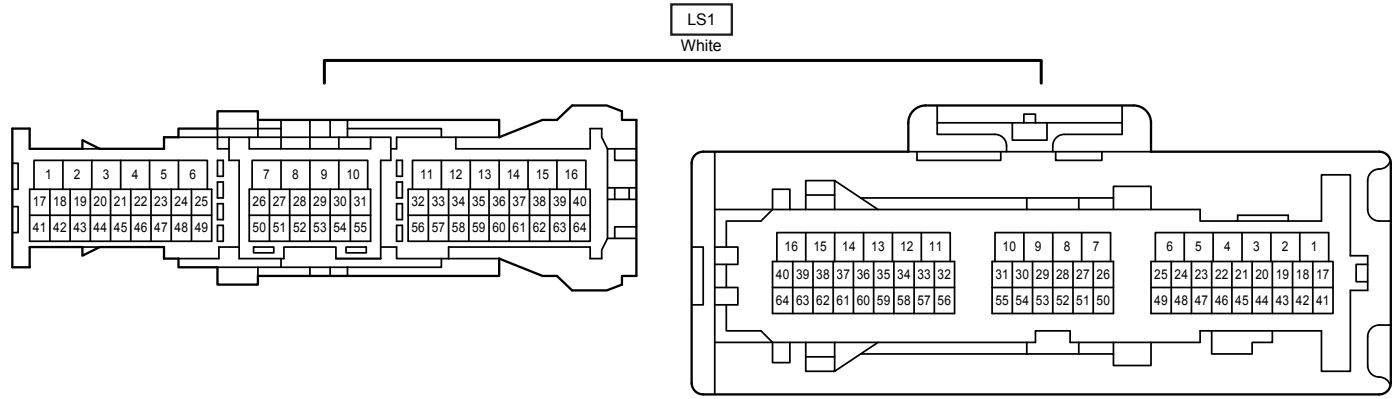



# Interior Light

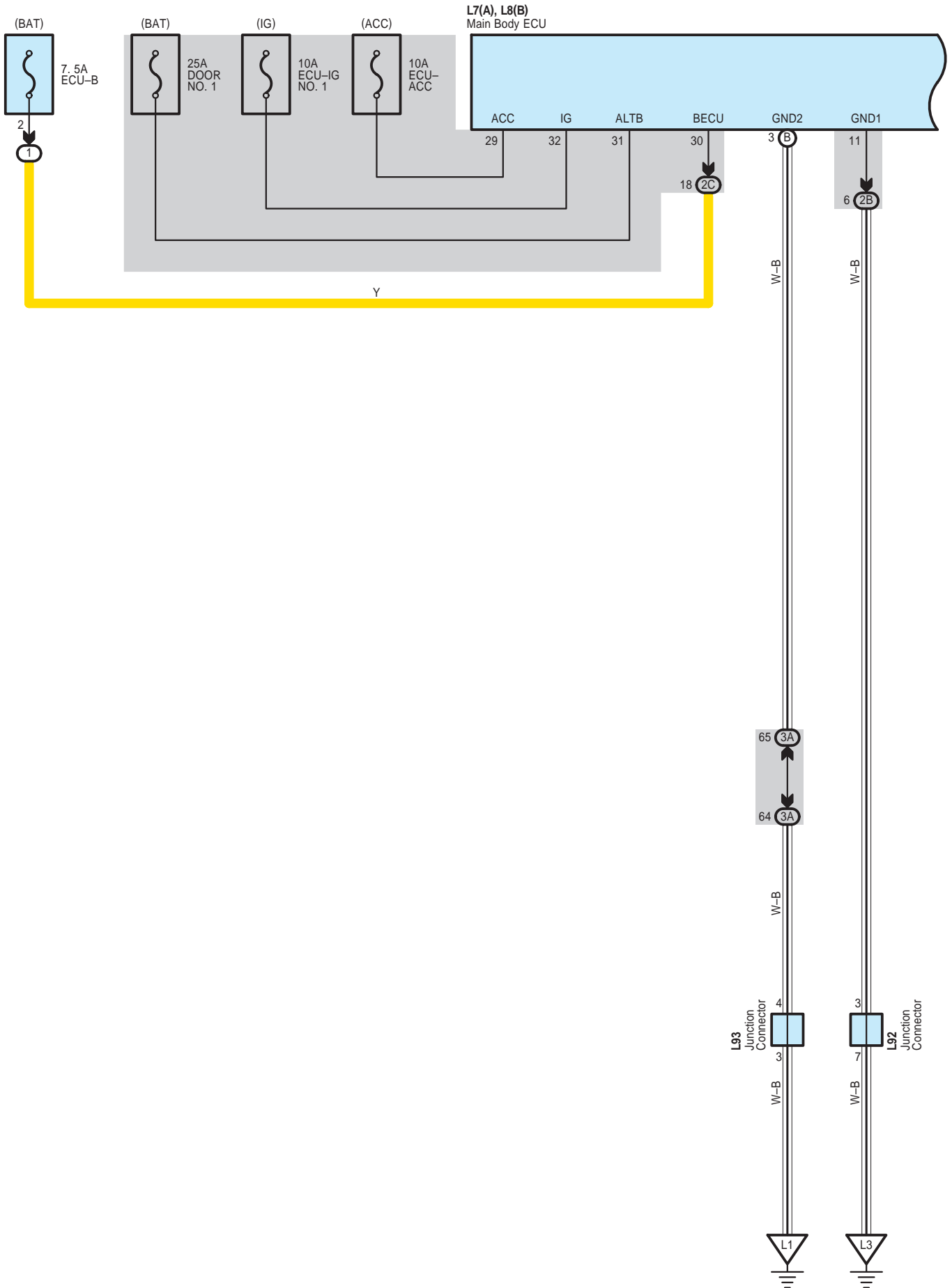



# Interior Light

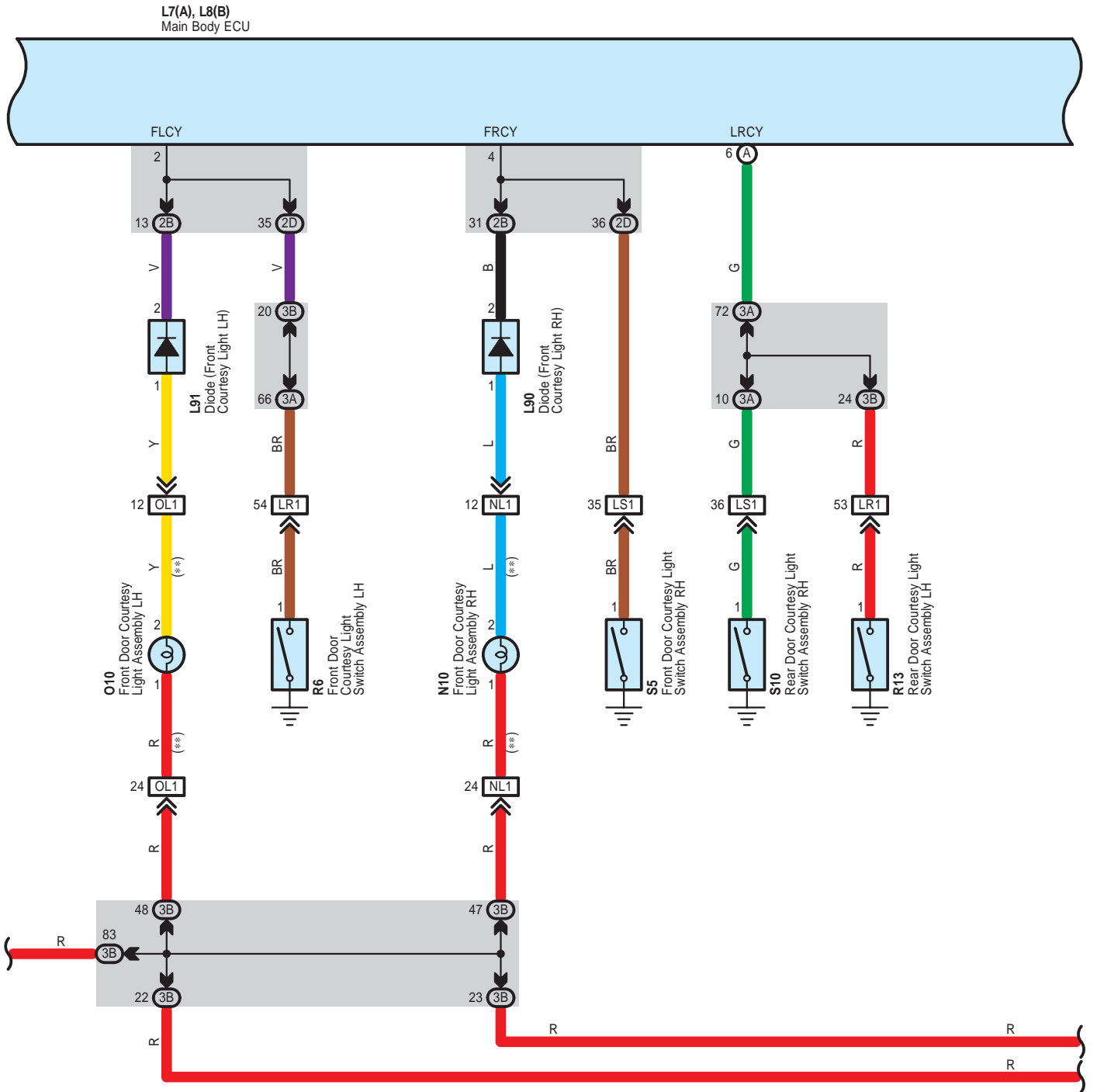

When wiring colors are indicated with (\*\*), either the colored wiring (general wiring) or the painted wiring is used.



# Interior Light

L7(A), L8(B)  
Main Body ECU

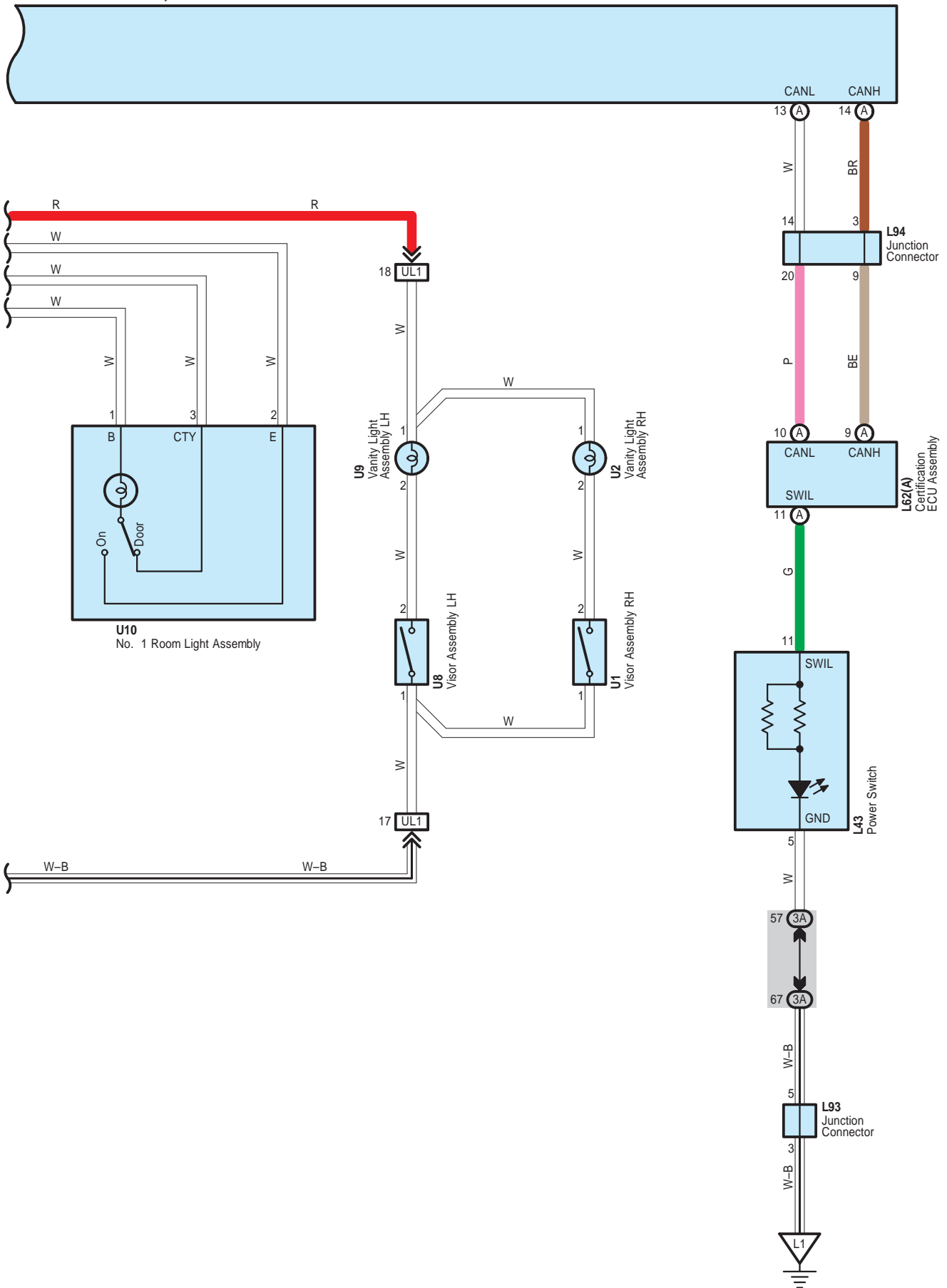

Interior Light

L 1  
White



L 7  
White

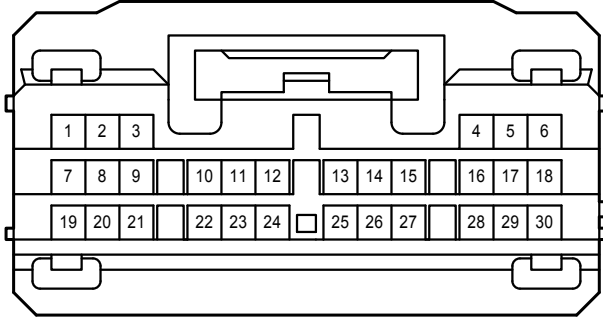

L 8  
White

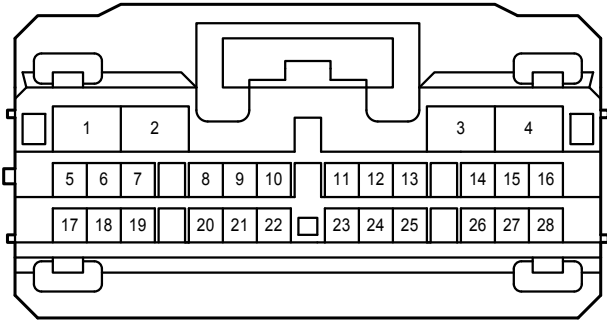

L 43  
Black

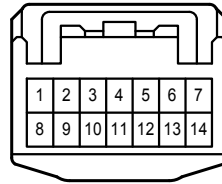

L 62  
White

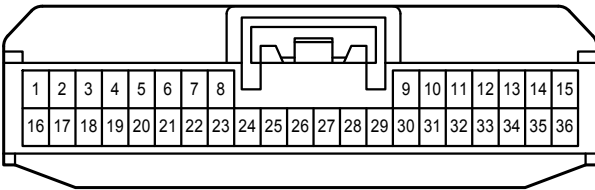

L 77  
Black

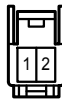

L 90  
Black



L 91  
Black



L 92  
White

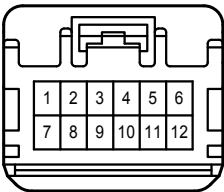

L 93  
White

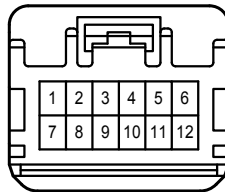

L 94  
White

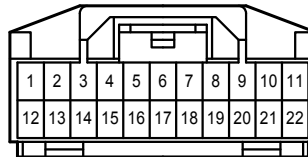

N 10  
White



O 10  
White



R 6  
Black



R 13  
Black



R 16  
White



R 18  
White

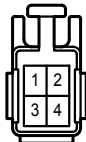

R 28  
White

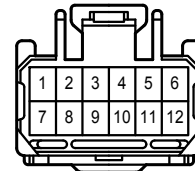

Interior Light

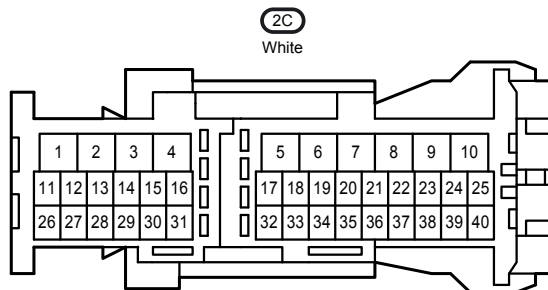
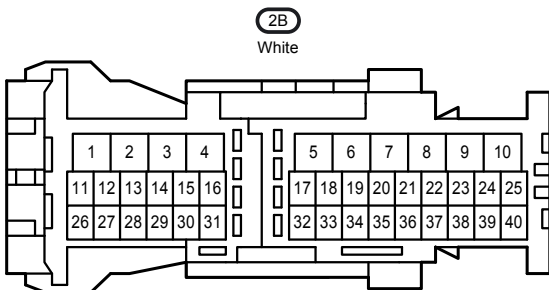
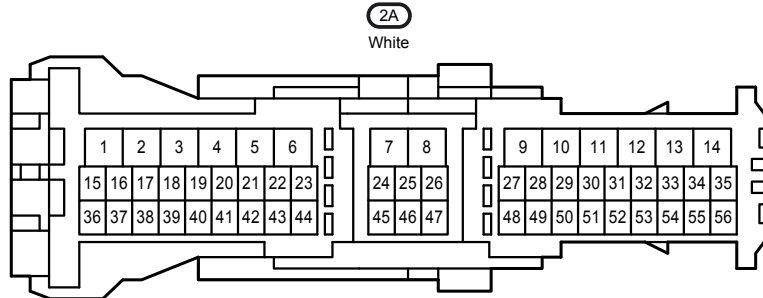
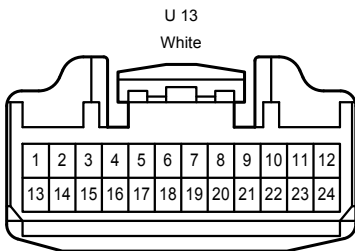
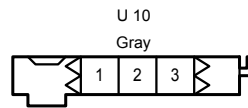
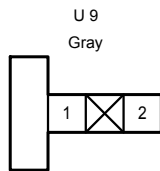
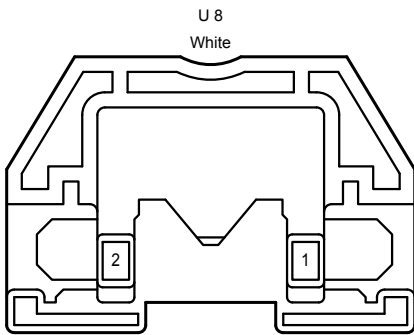
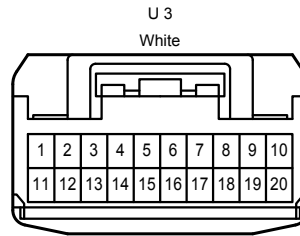
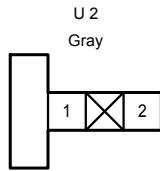
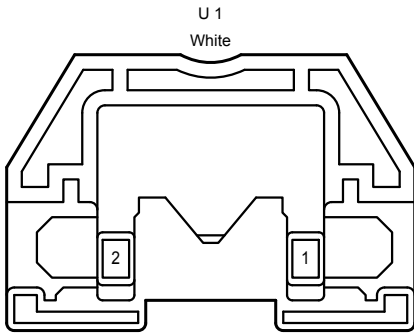
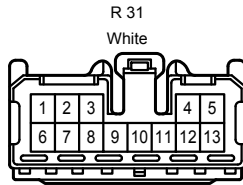
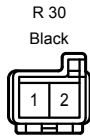
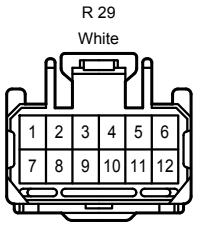

Interior Light

2D  
White

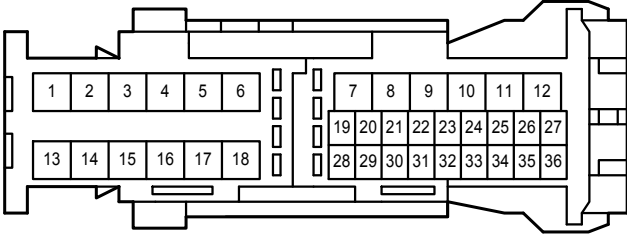

3A  
White

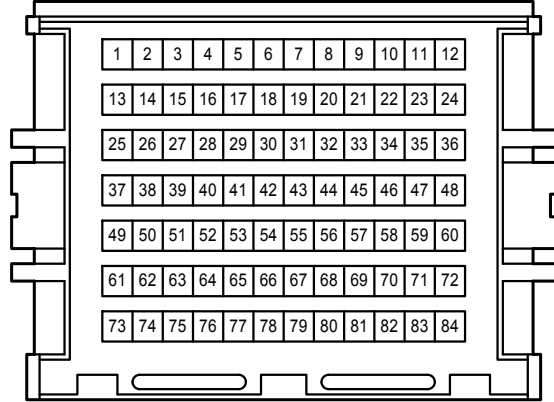

3B  
White

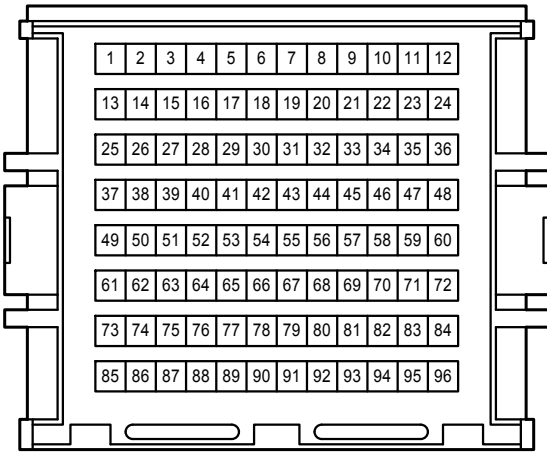

LR1  
White

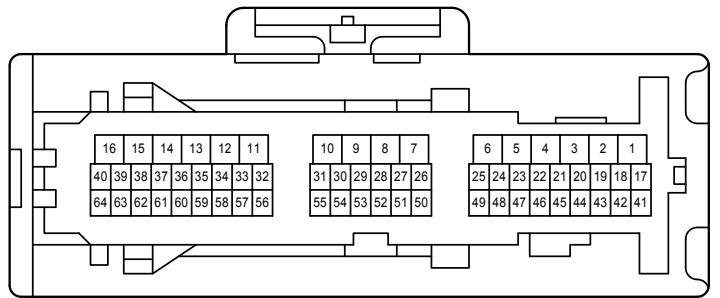
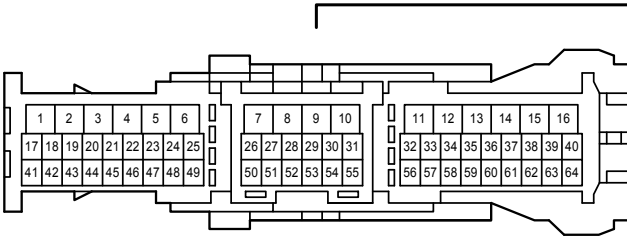

LS1  
White

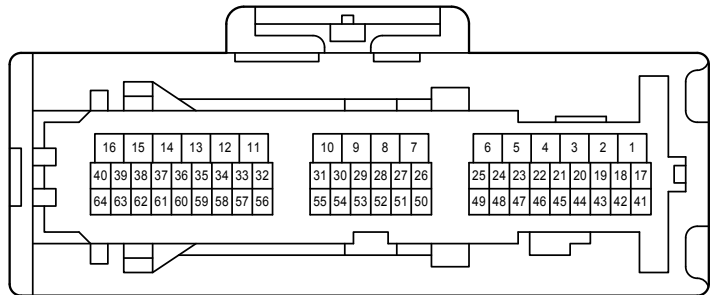
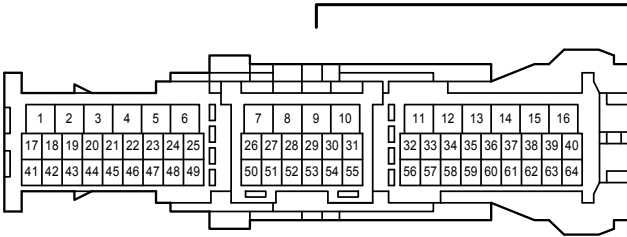



# Interior Light

NL1  
White

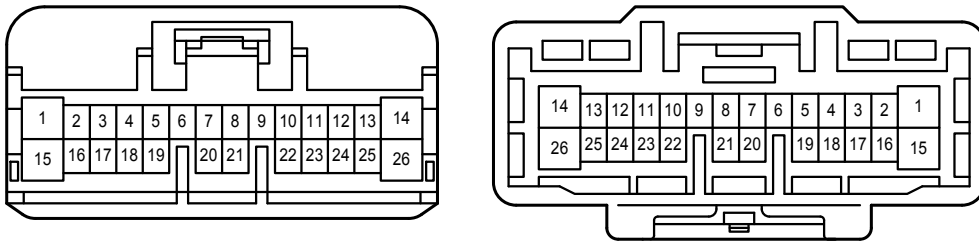

OL1  
White

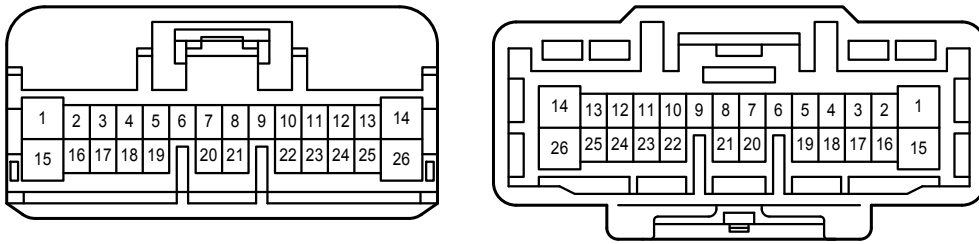

UL1  
Gray

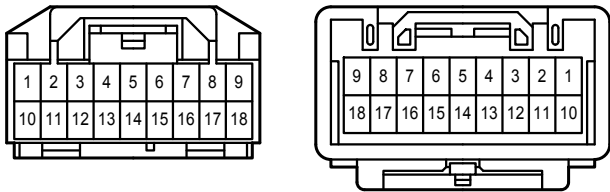

Lane Keeping Assist

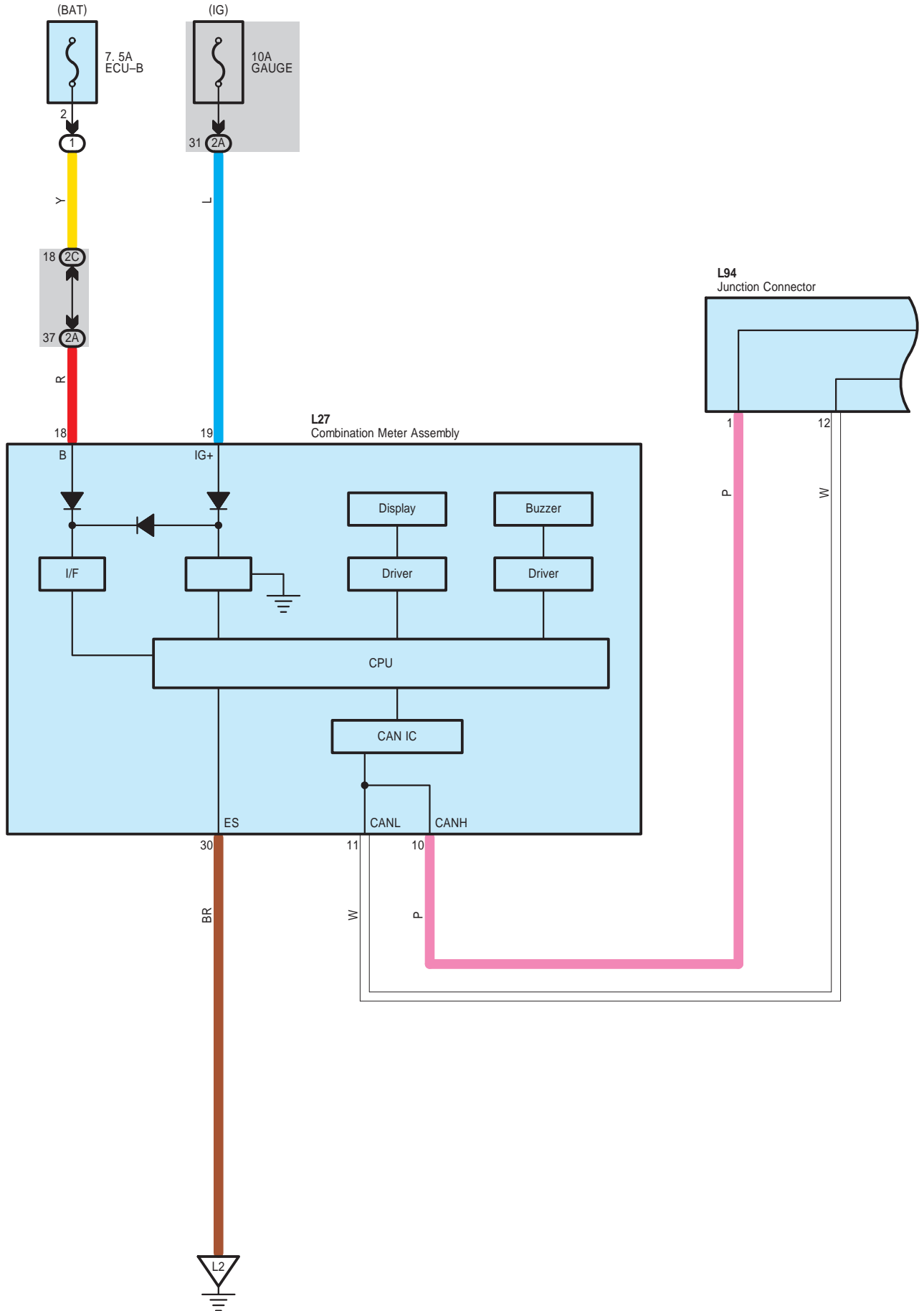

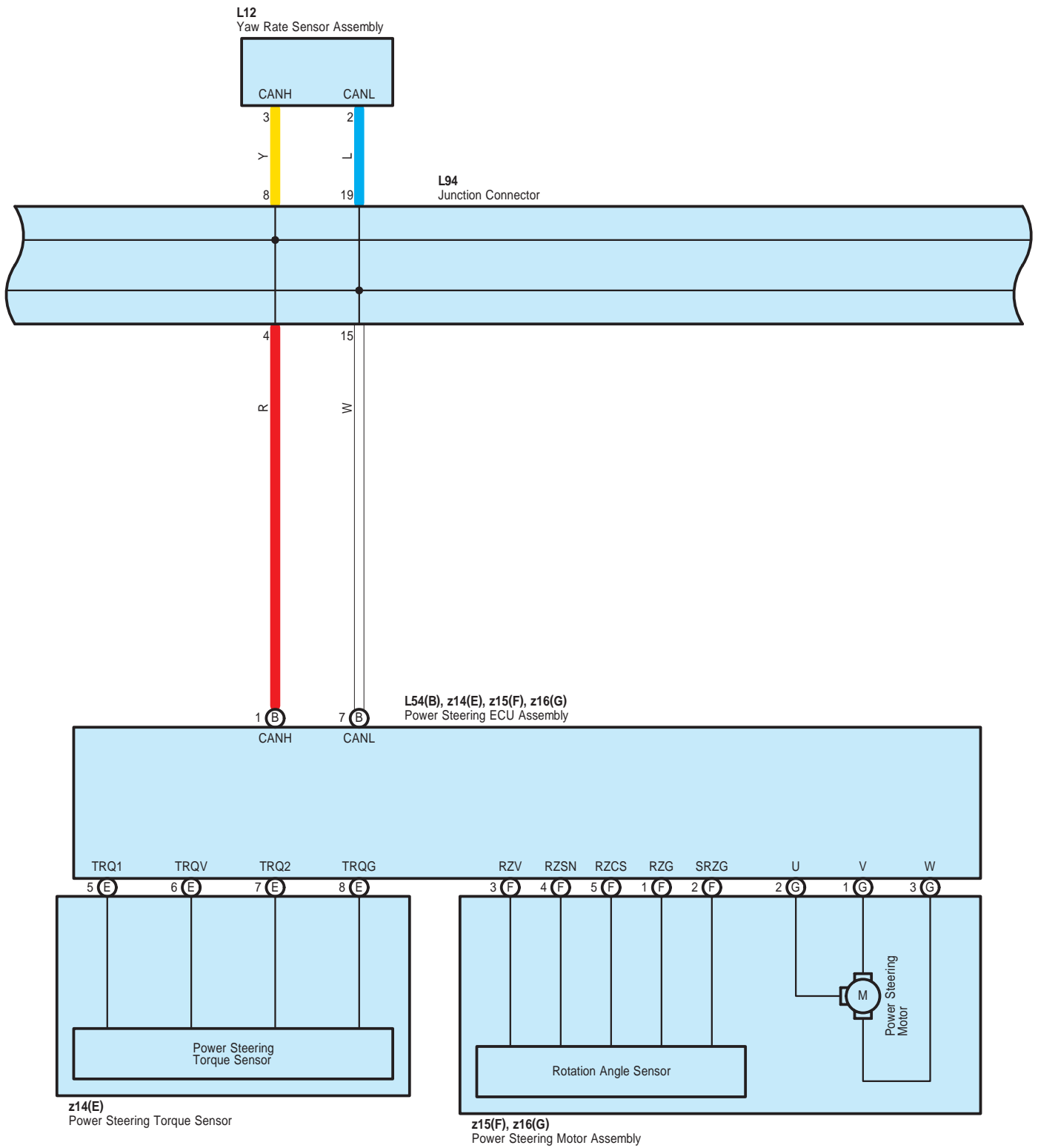

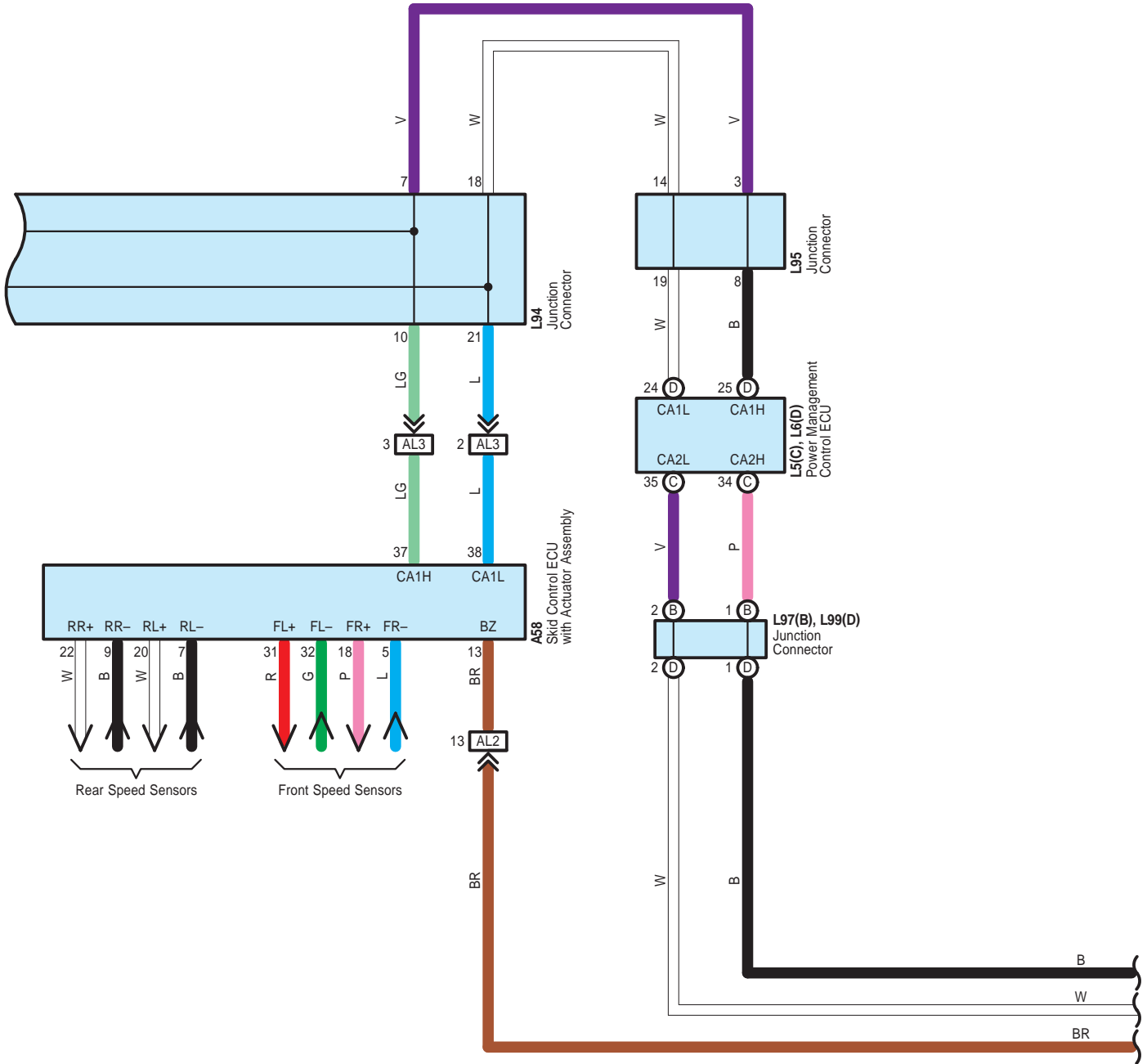

# Lane Keeping Assist

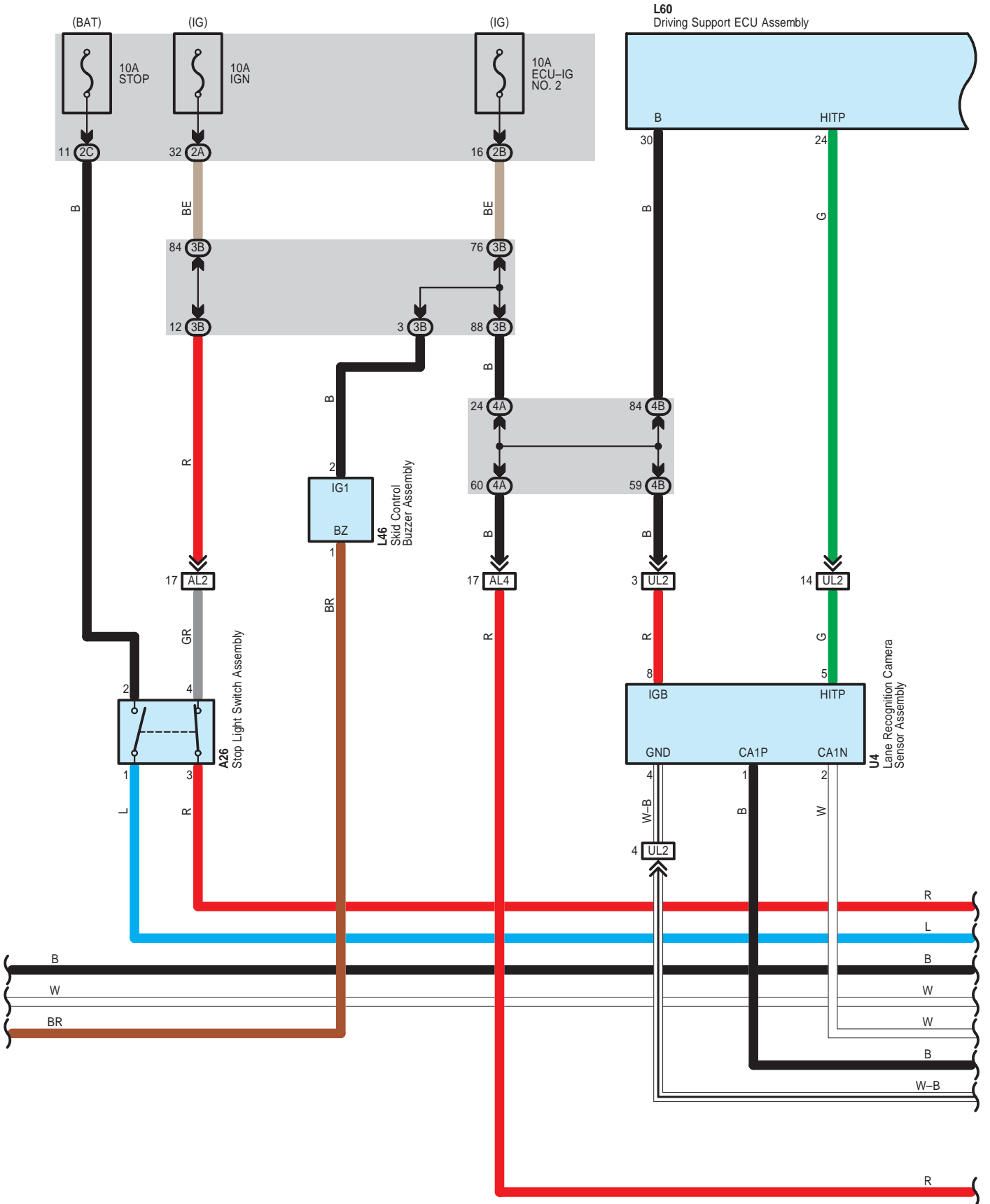

Lane Keeping Assist

L60  
Driving Support ECU Assembly

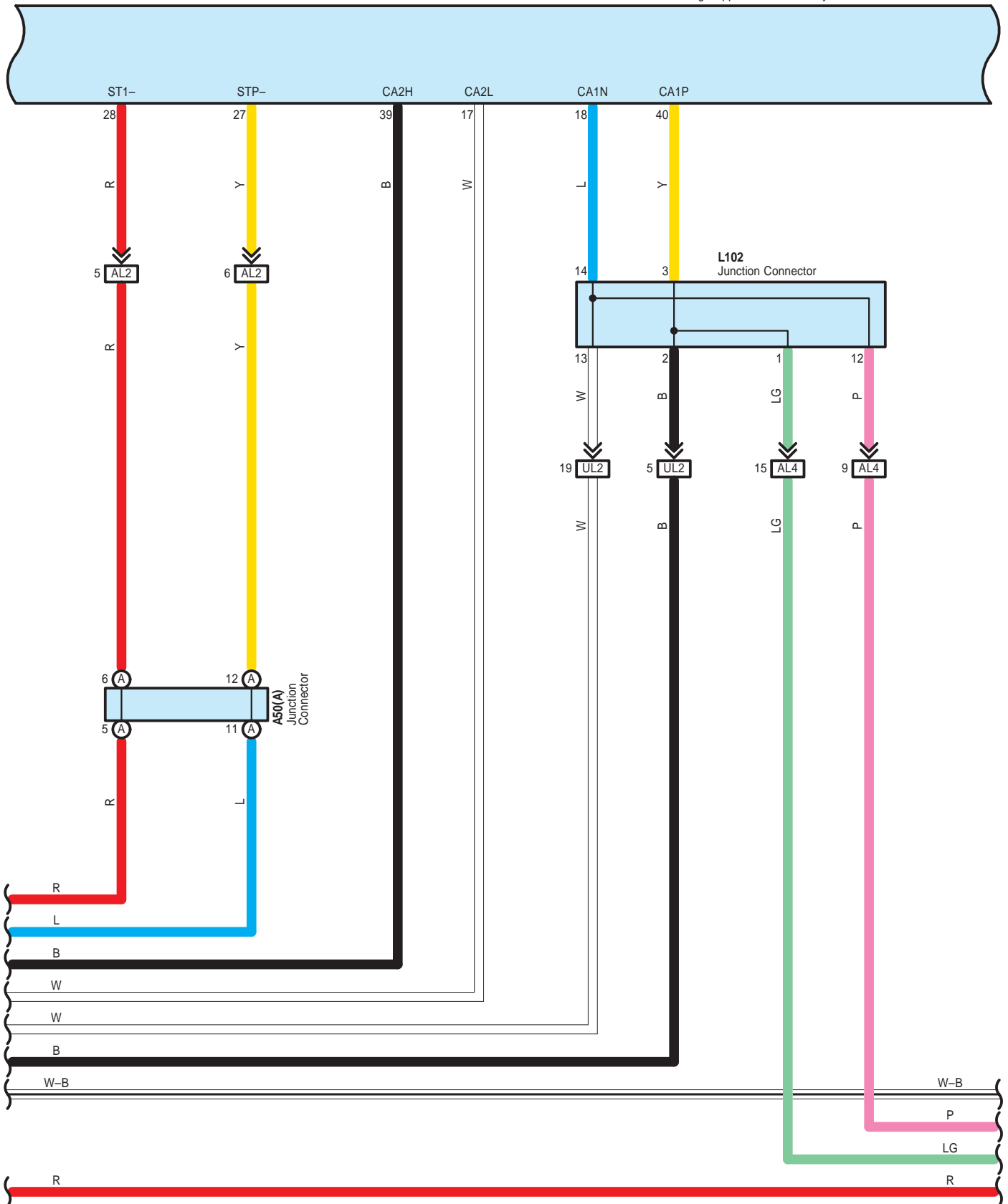

# Lane Keeping Assist

**L60**  
Driving Support ECU Assembly

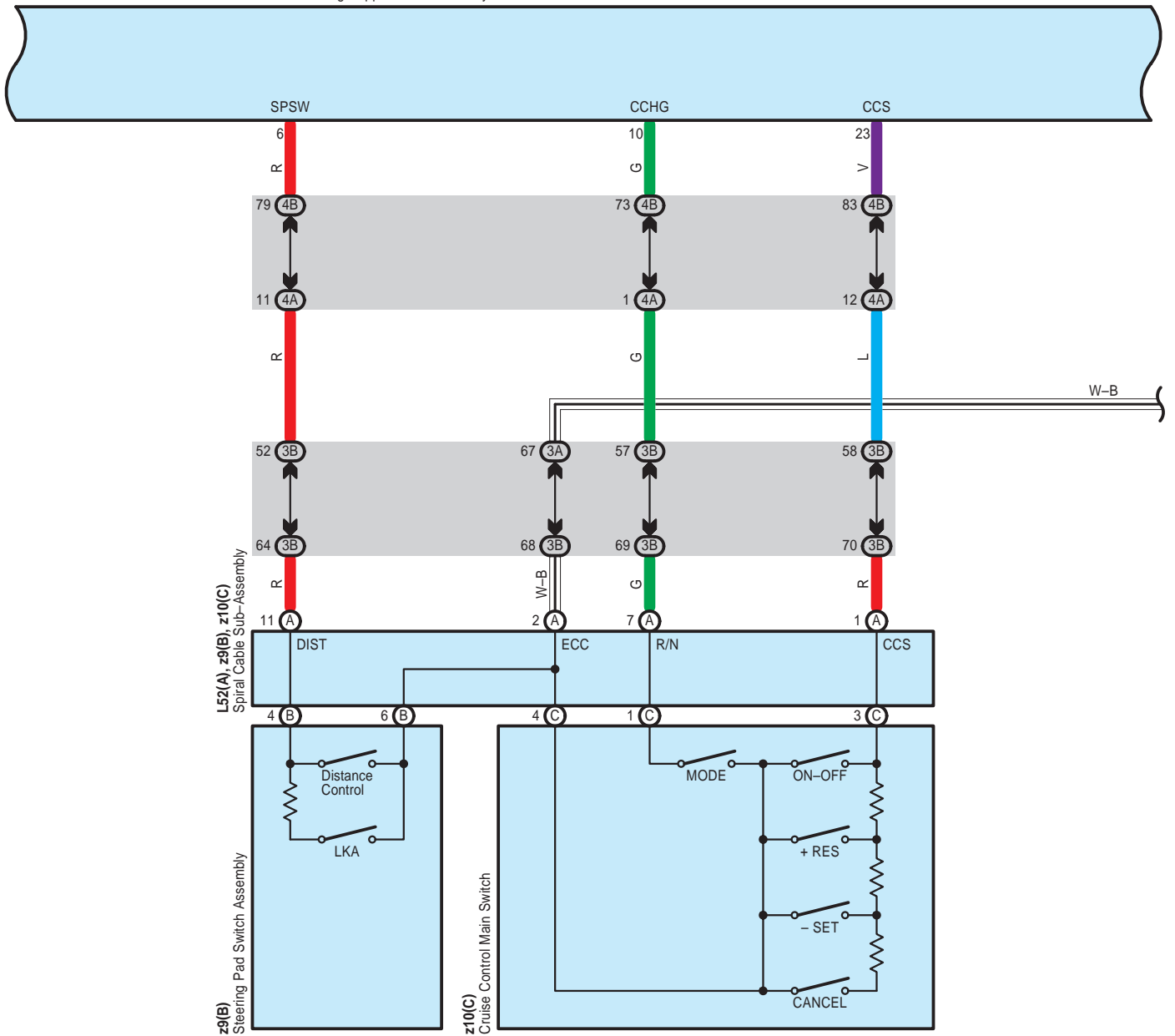

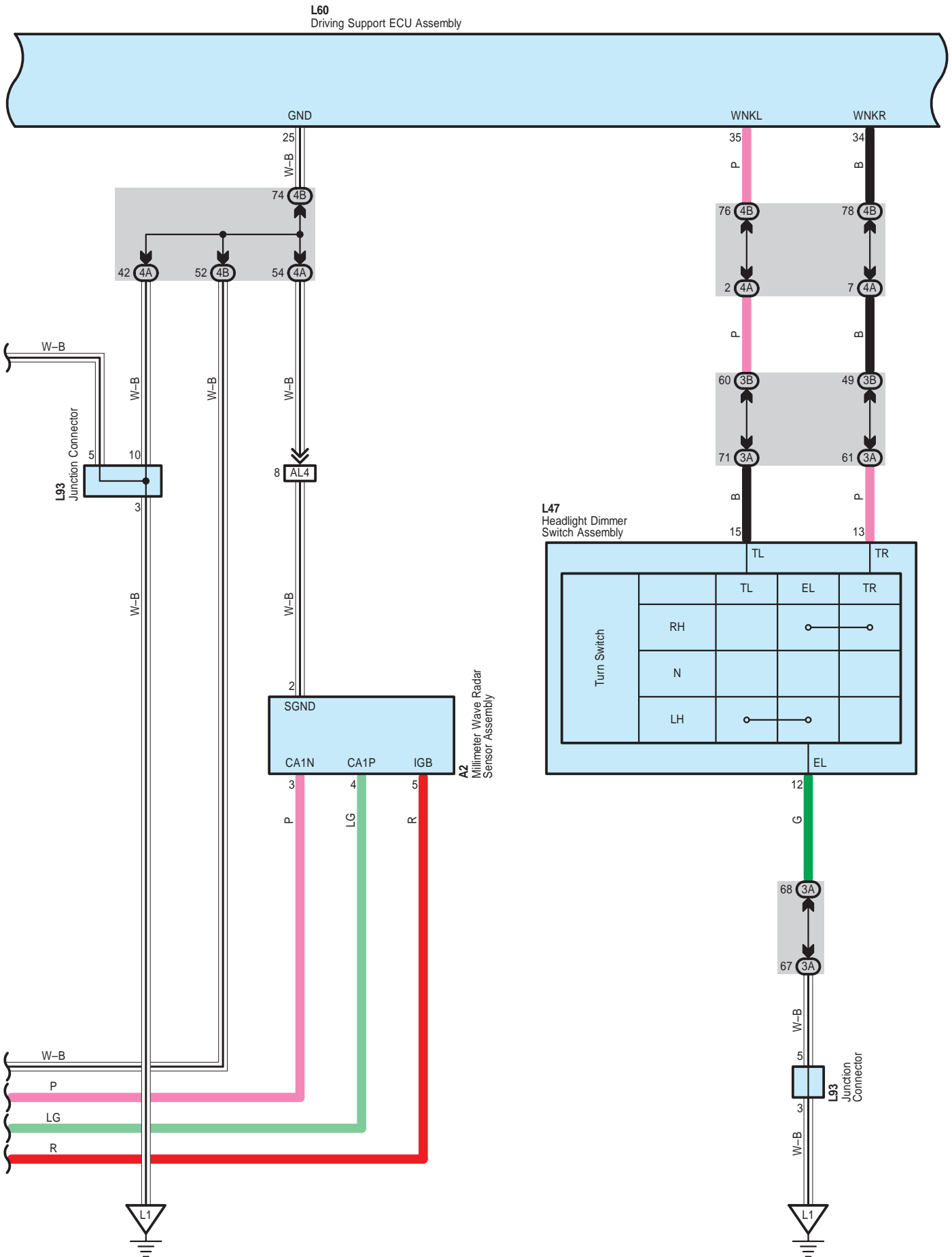



# Lane Keeping Assist

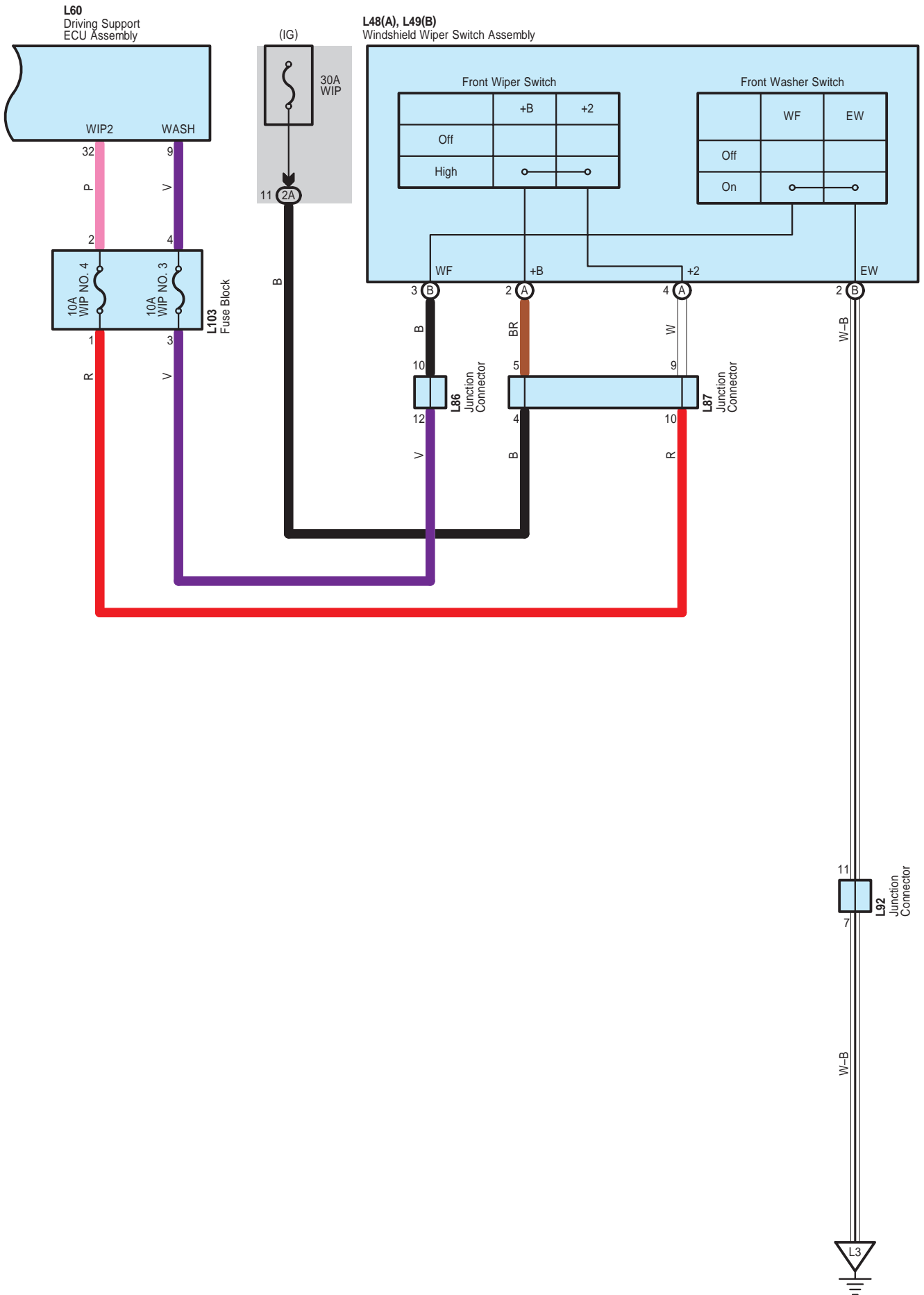

Lane Keeping Assist

A 2

Black



A 26

White

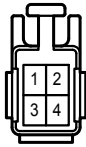

A 50

White

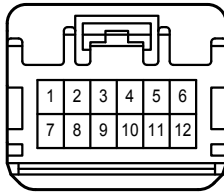

A 58

Gray

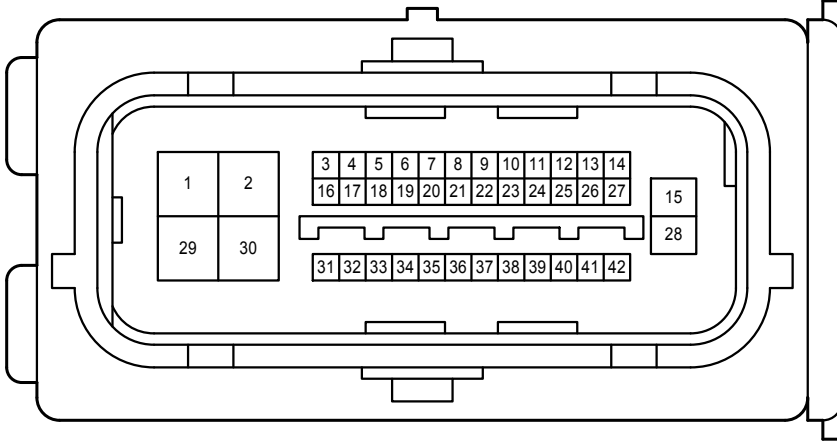

L 5

Gray

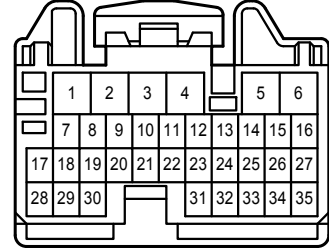

L 6

Gray

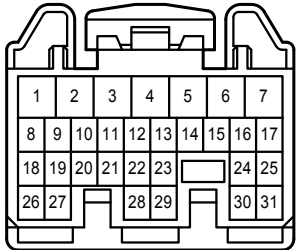

L 12

Black

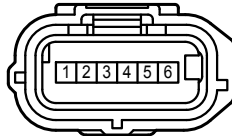

L 27

White

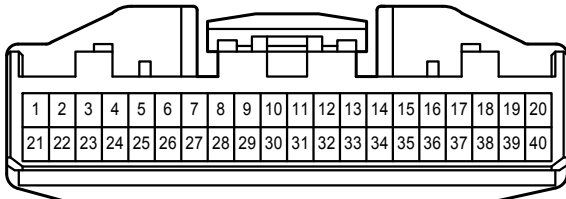

L 46

Blue

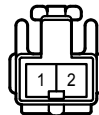

L 47

White

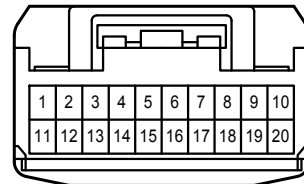

L 48

White



L 49

White

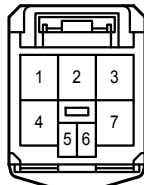

L 52

Black

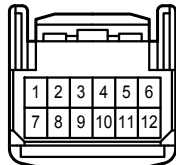

L 54

White

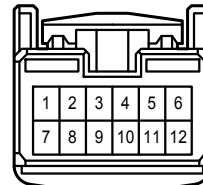

Lane Keeping Assist

L 60  
White

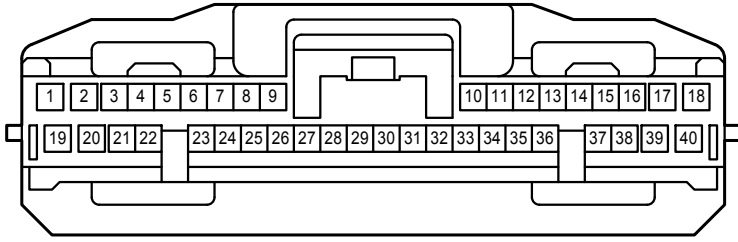

L 86  
Black

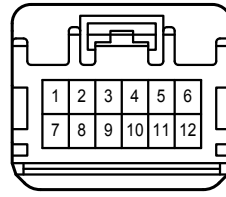

L 87  
Black

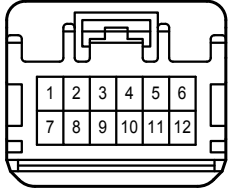

L 92  
White

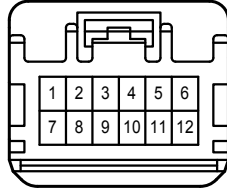

L 93  
White

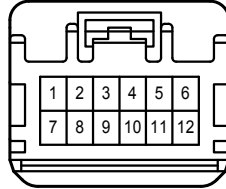

L 94  
White

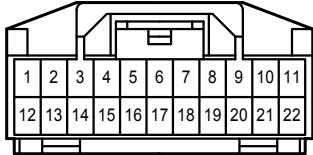

L 95  
White

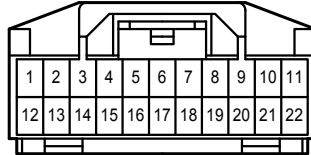

L 97  
White

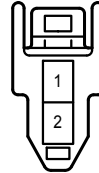

L 99  
White

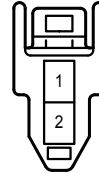

L102  
Blue

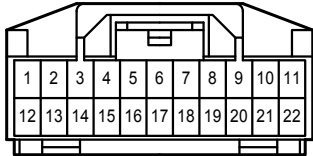

L103  
White

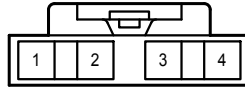

U 4  
White

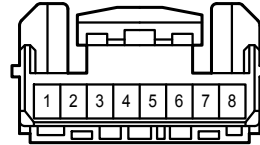

z 9  
Black

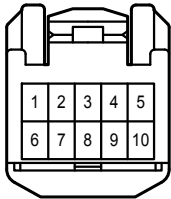

z 10  
Black

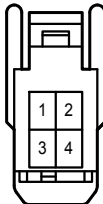

z 14  
White

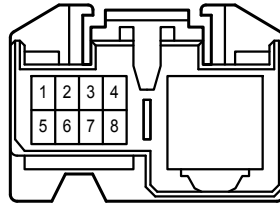

z 15  
White

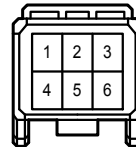

z 16  
White

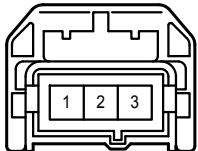

2A  
White

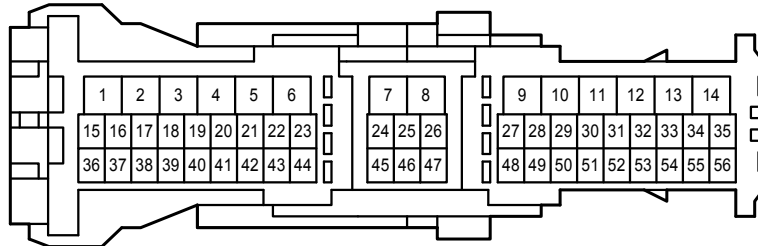

Lane Keeping Assist

2B

White

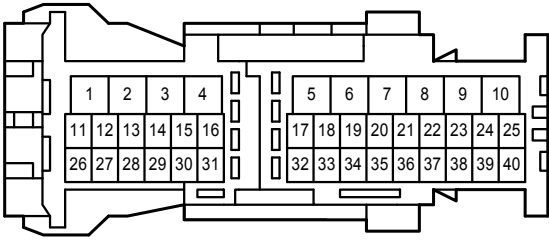

2C

White

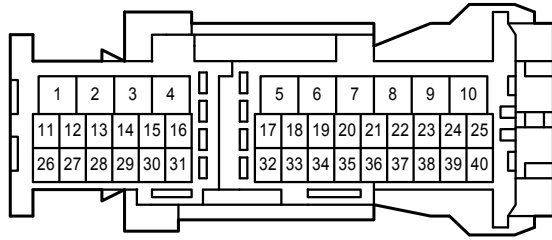

3A

White

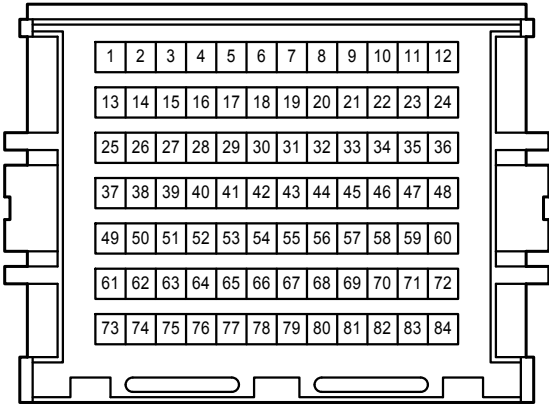

3B

White

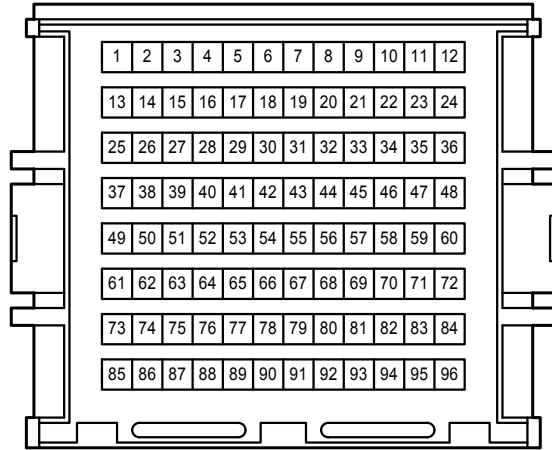

4A

White

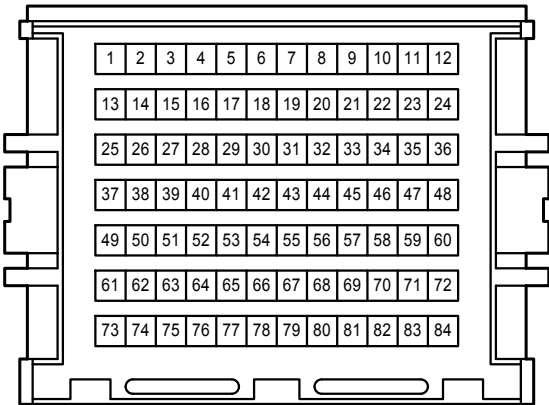

4B

White

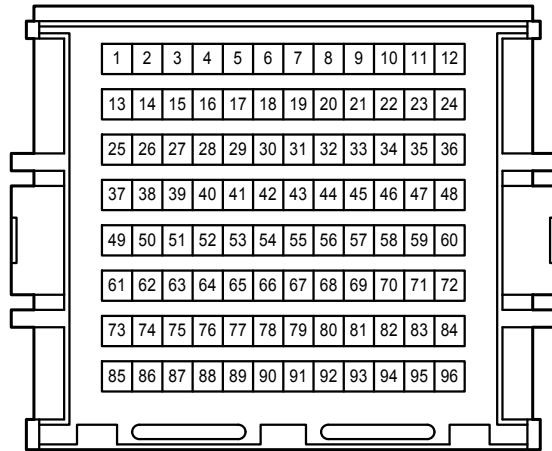

AL2

Gray

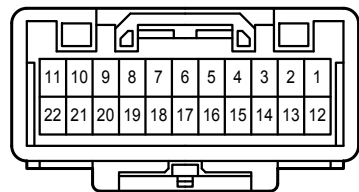
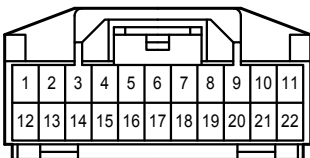

# Lane Keeping Assist

AL3  
White

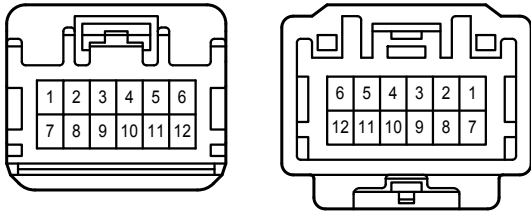

AL4  
Black

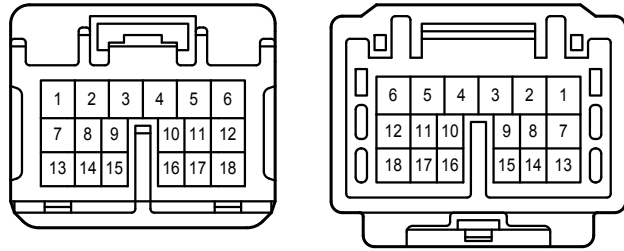

UL2  
White

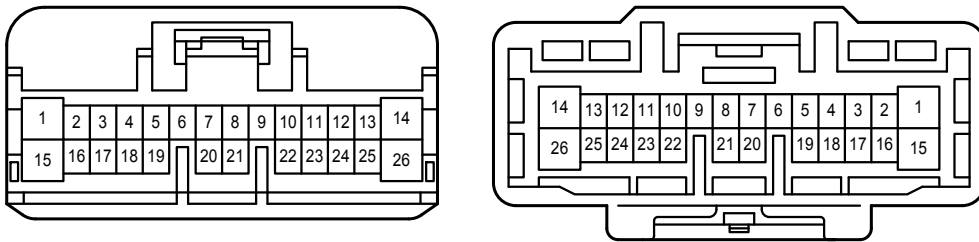

# Mirror Heater , Rear Window Defogger

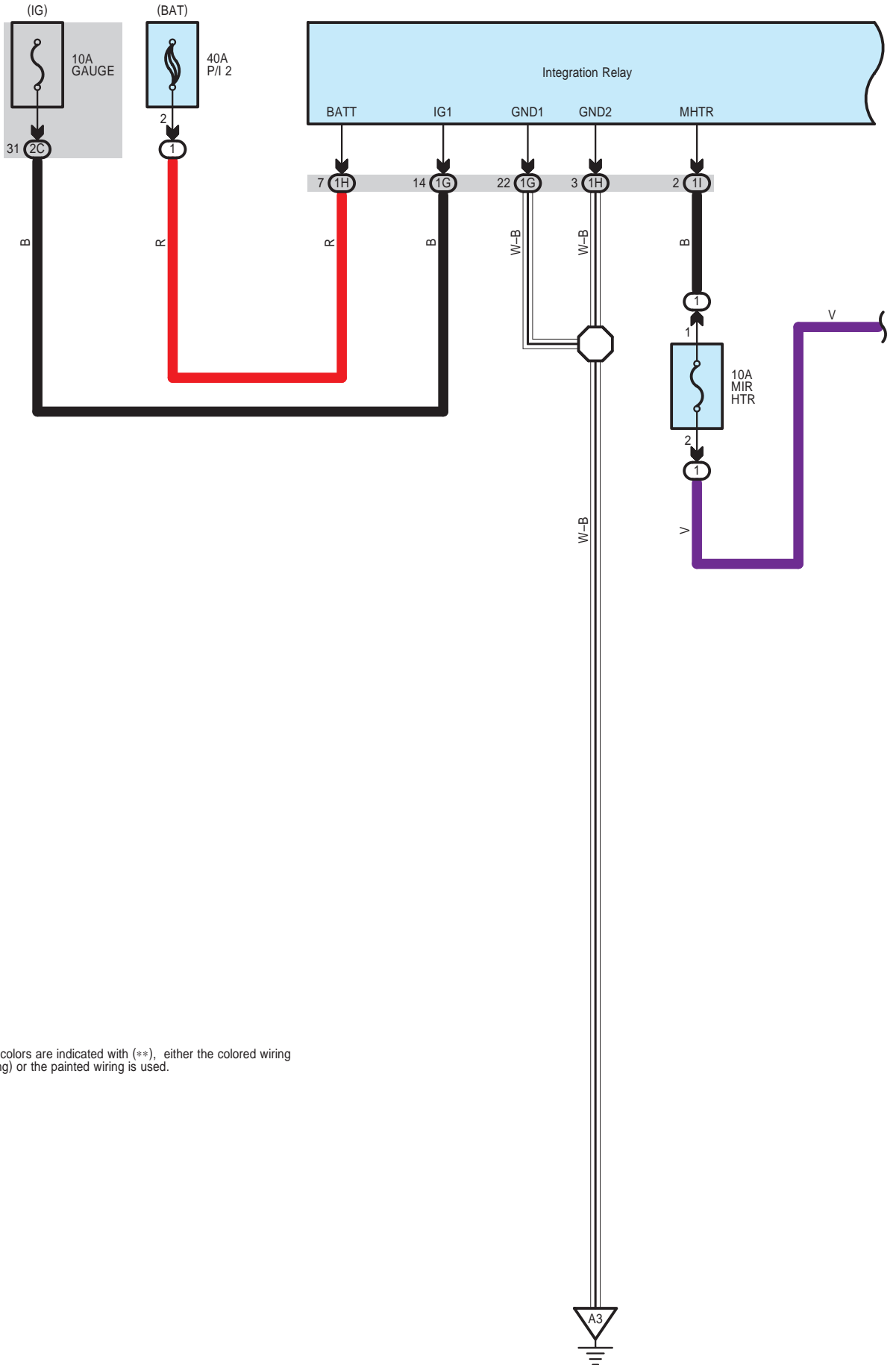

When wiring colors are indicated with (\*\*), either the colored wiring (general wiring) or the painted wiring is used.

Mirror Heater , Rear Window Defogger

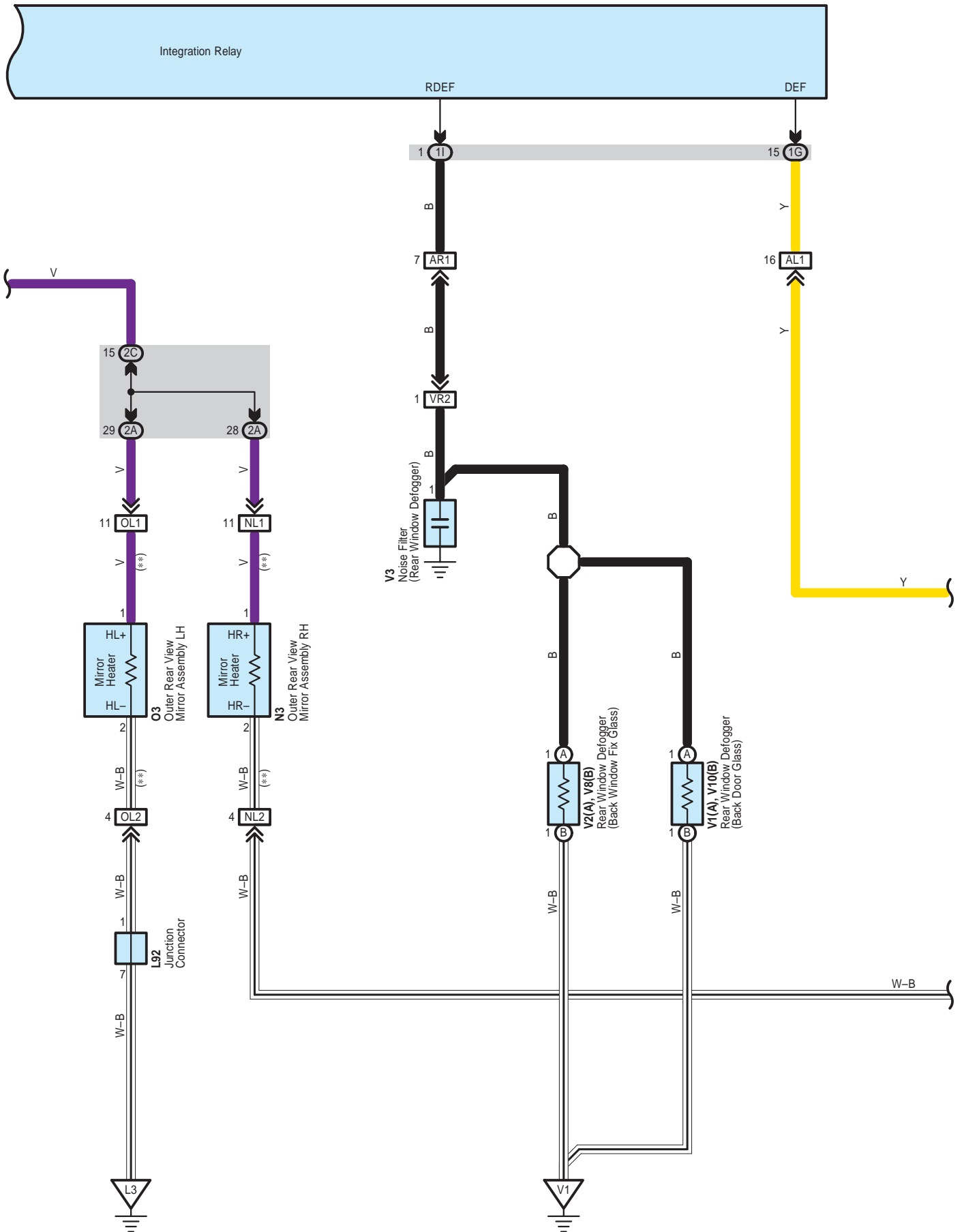

# Mirror Heater , Rear Window Defogger

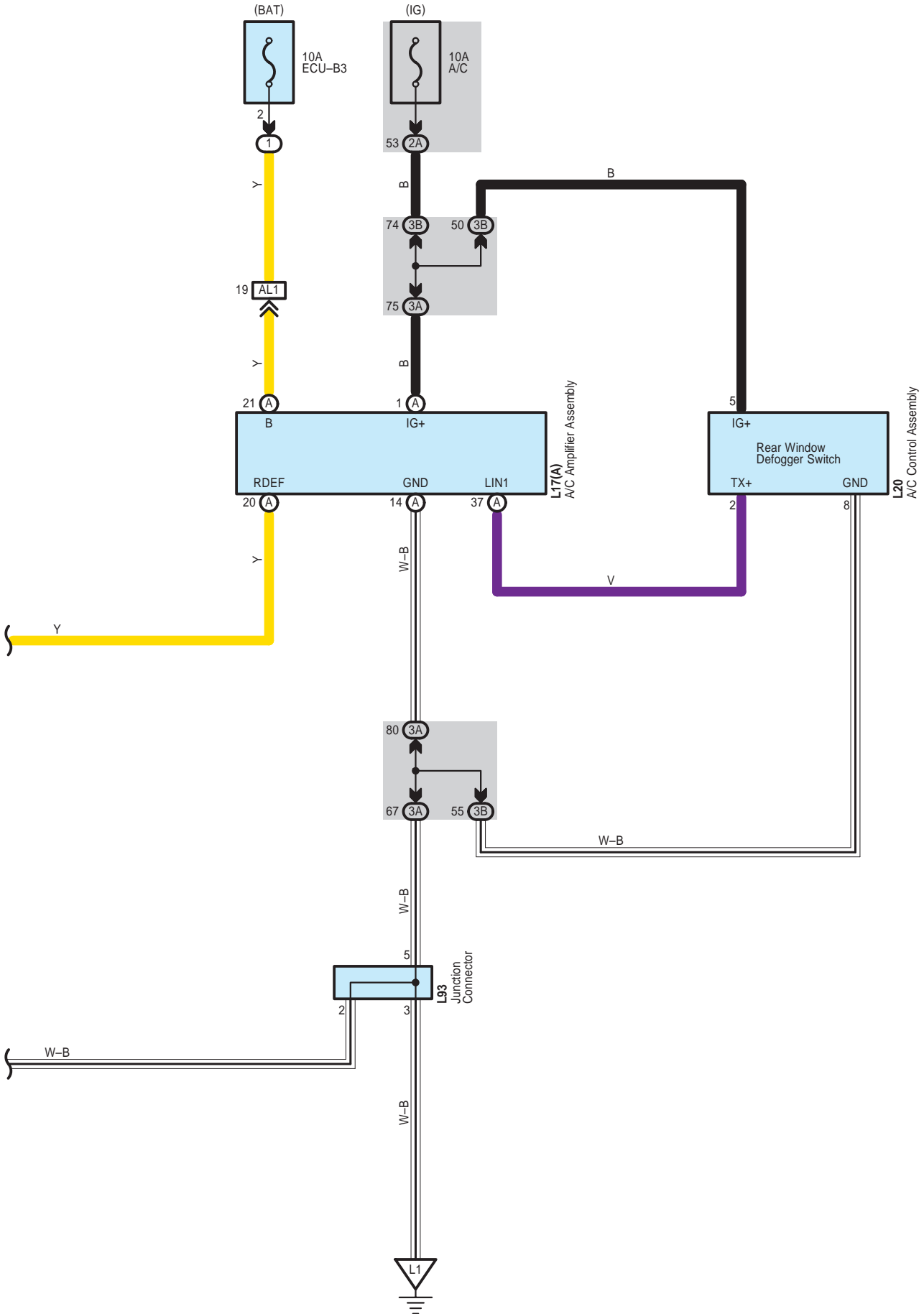



Mirror Heater , Rear Window Defogger

L 17  
White

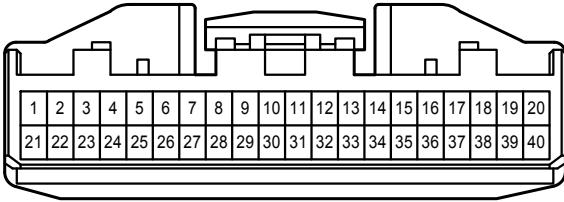

L 20  
Black

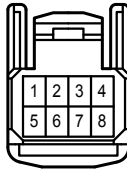

L 92  
White

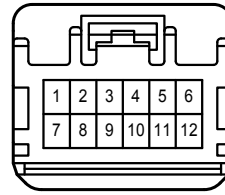

L 93  
White

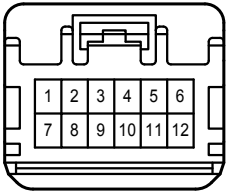

N 3  
White

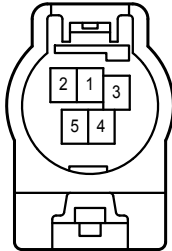

O 3  
White

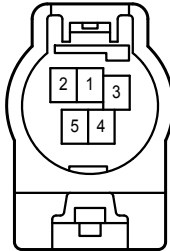

V 1  
White



V 2  
White



V 3  
Black

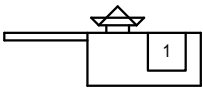

V 8  
White



V 10  
White



1G  
White

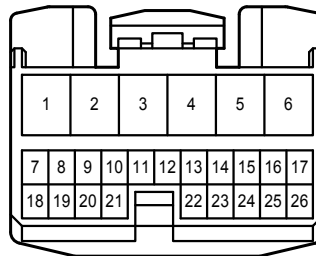

1H  
White

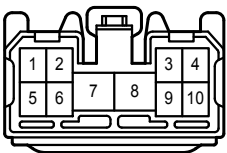

1I  
White

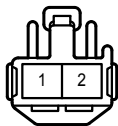

2A  
White

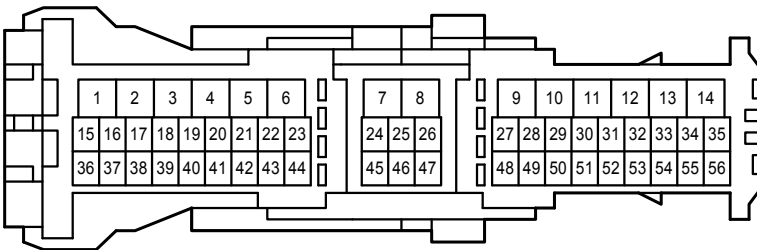

Mirror Heater , Rear Window Defogger

2C

White

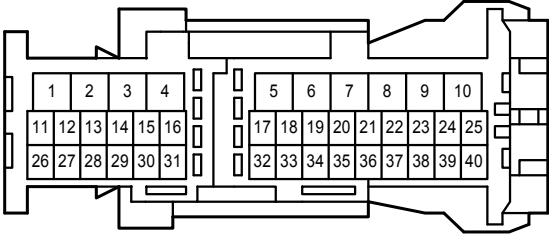

3A

White

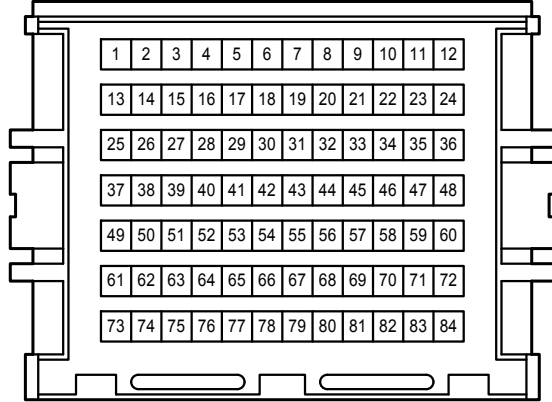

3B

White

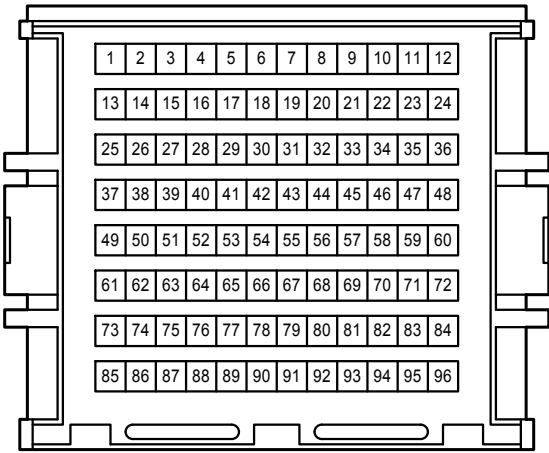

AL1

Blue

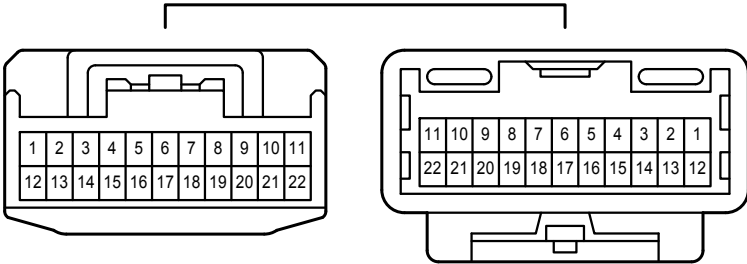

AR1

White

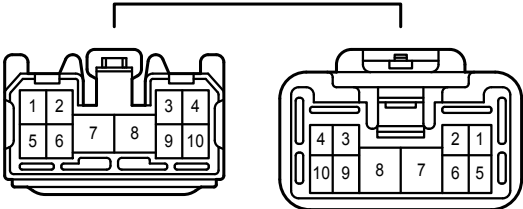

Mirror Heater , Rear Window Defogger

NL1  
White

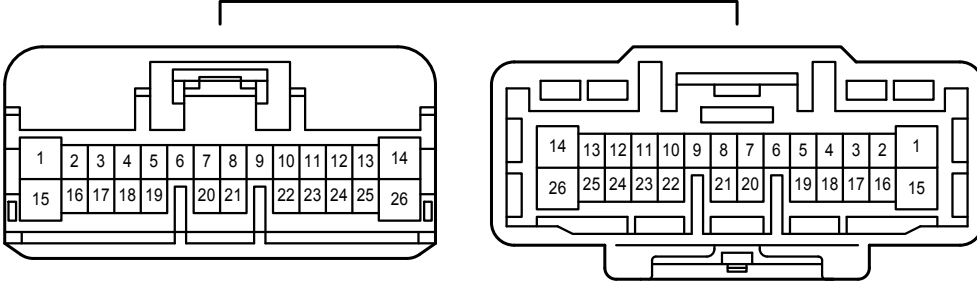

NL2  
White

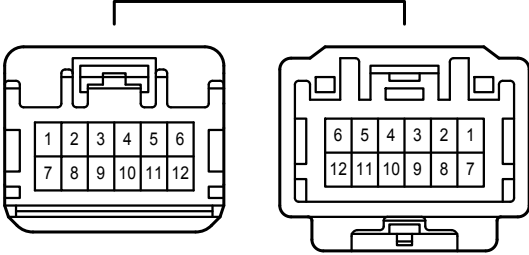

OL1  
White

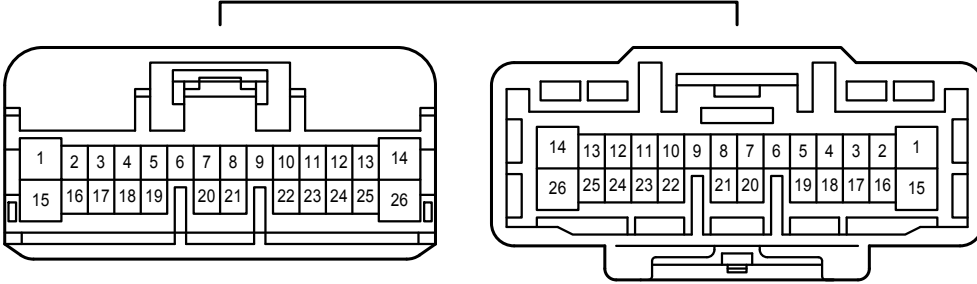

OL2  
White

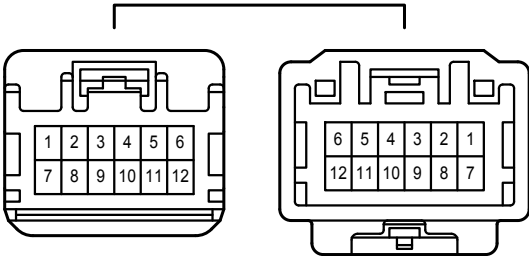

VR2  
White

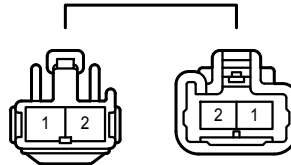

L40(D), L41(E)  
Navigation Receiver Assembly  
L40(D), L41(E)  
Radio Receiver Assembly

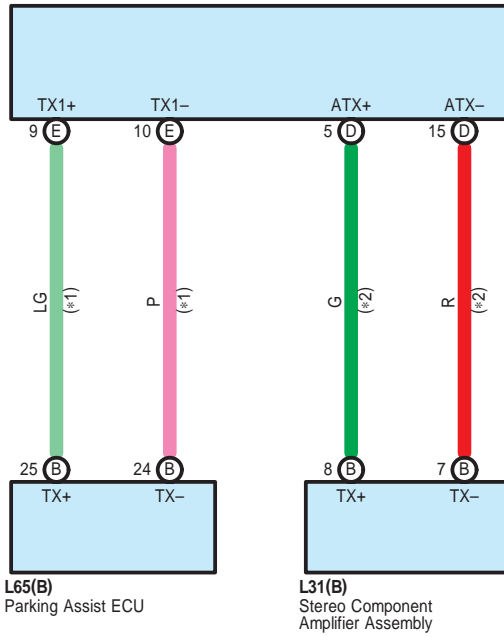

- \* 1 : w/ Intelligent Parking Assist
- \* 2 : w/ Stereo Component Amplifier



Multiplex Communication System <CAN>

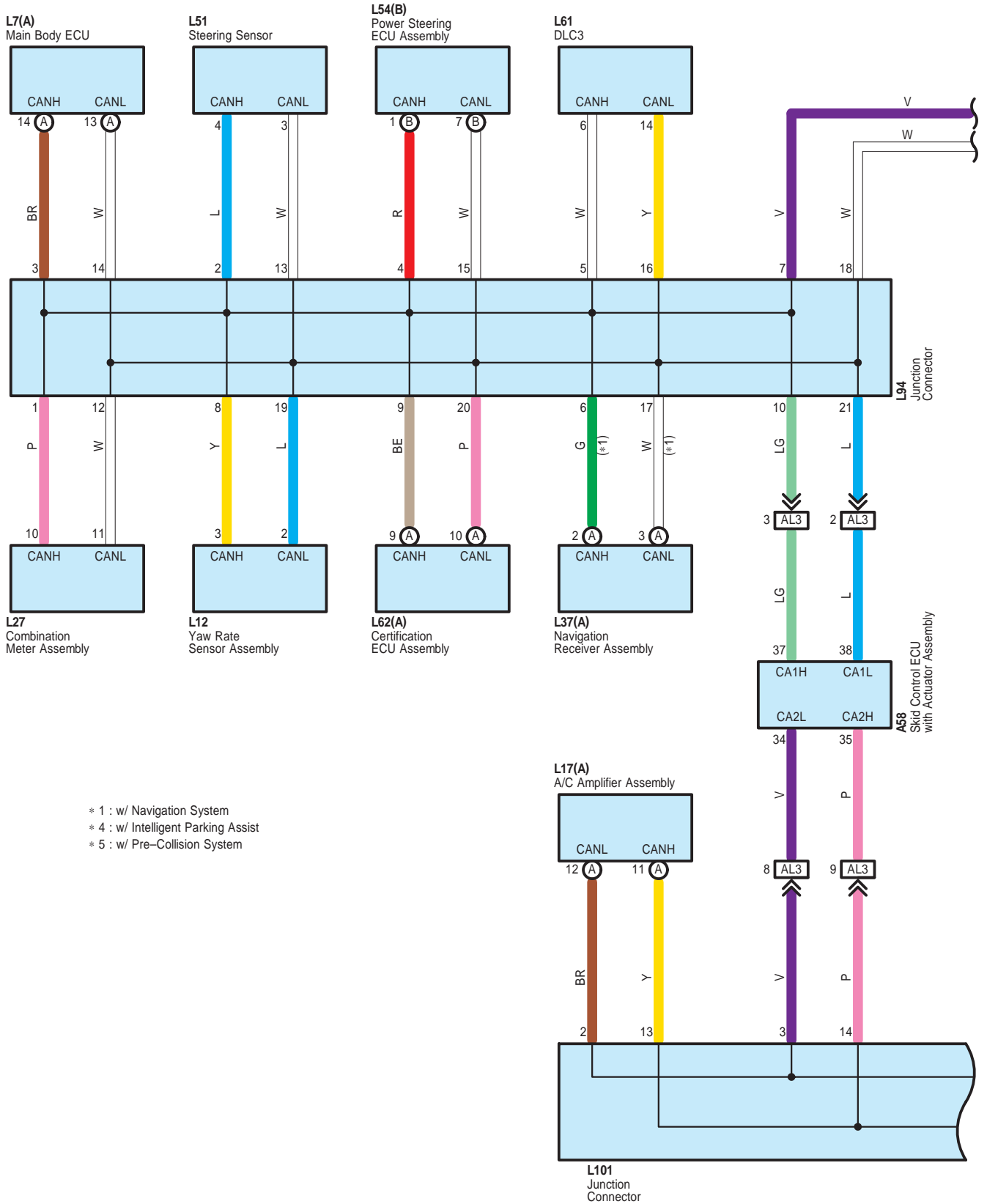

Multiplex Communication System <CAN>

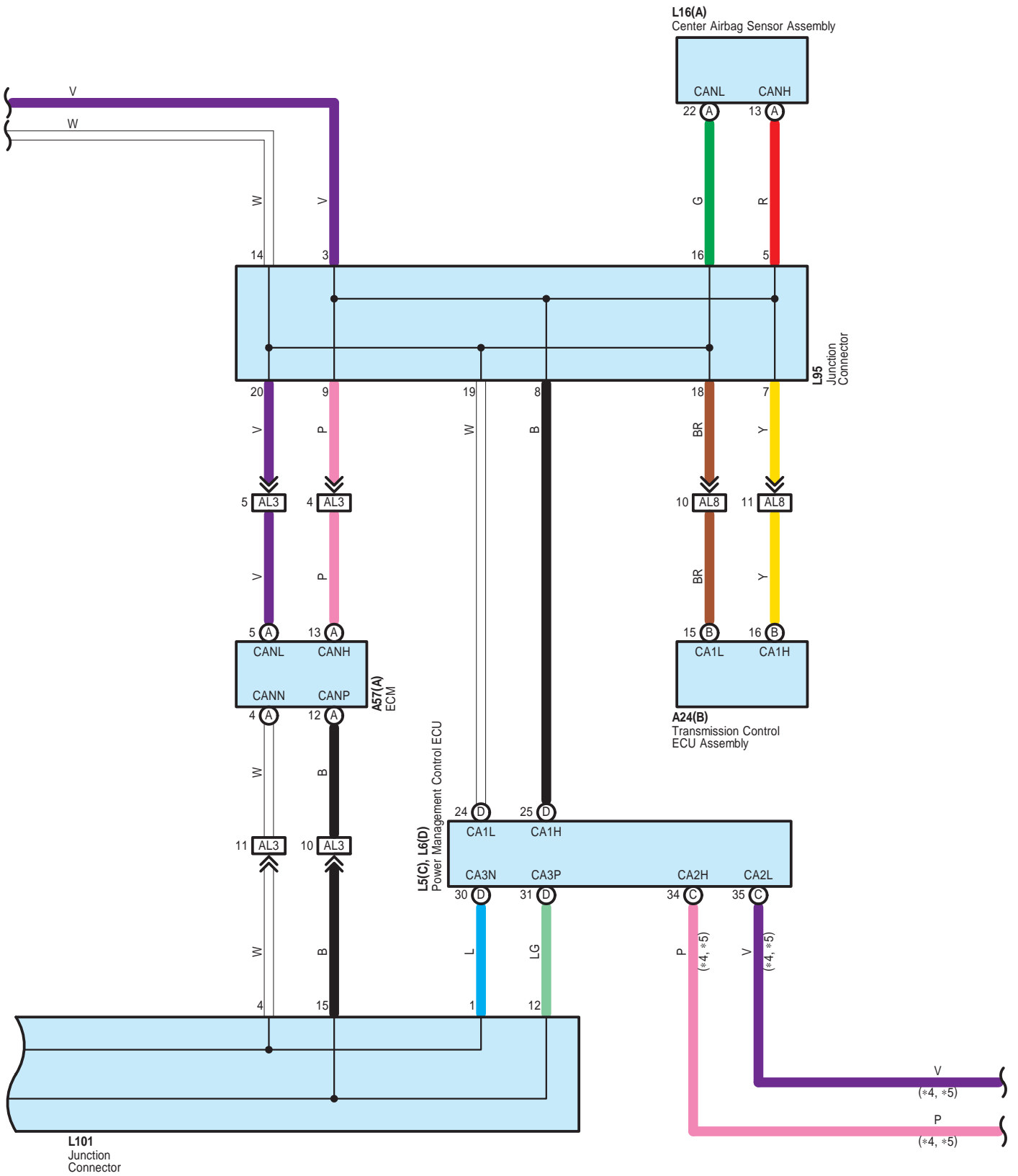

# Multiplex Communication System <CAN>

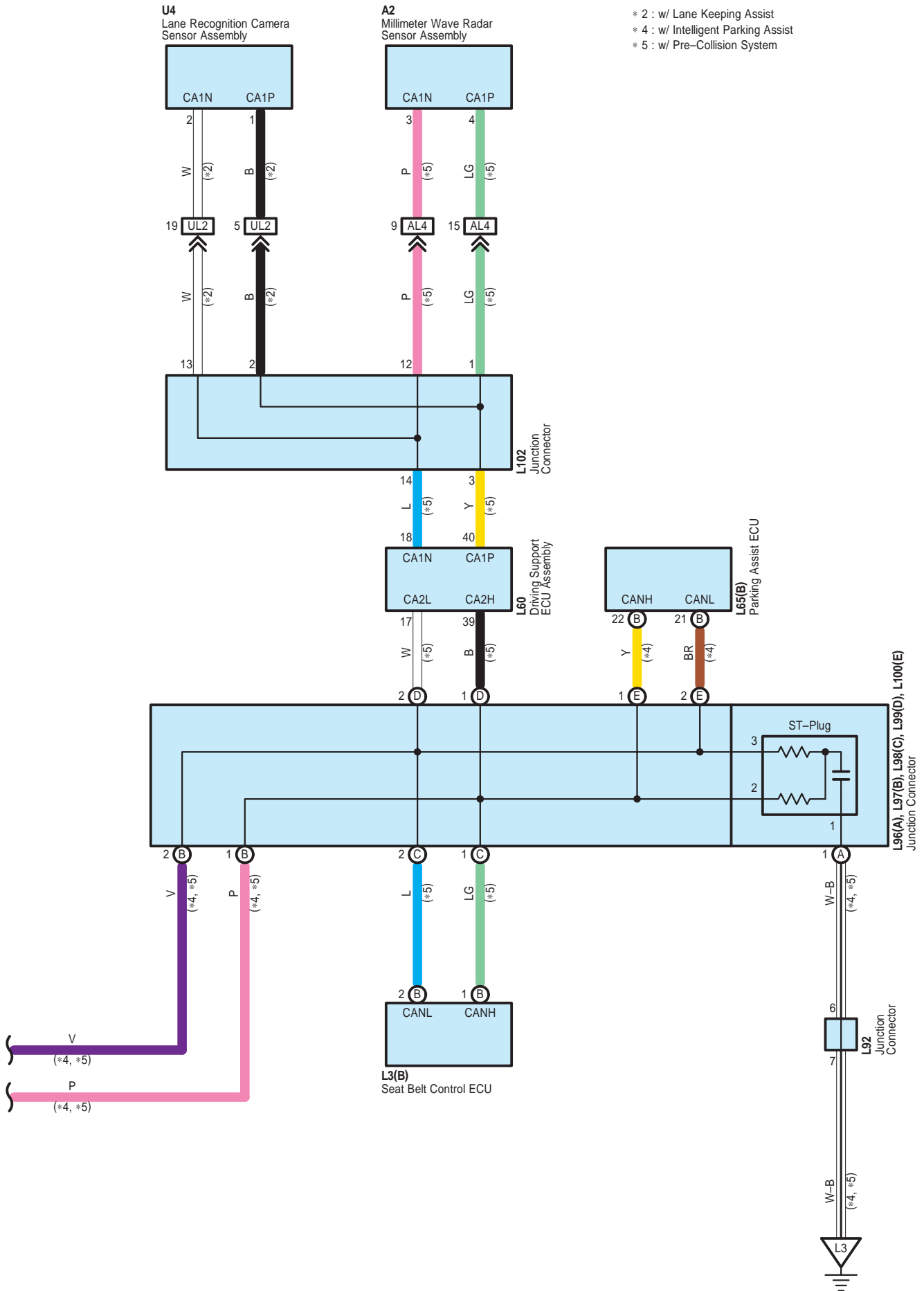





L 7  
White

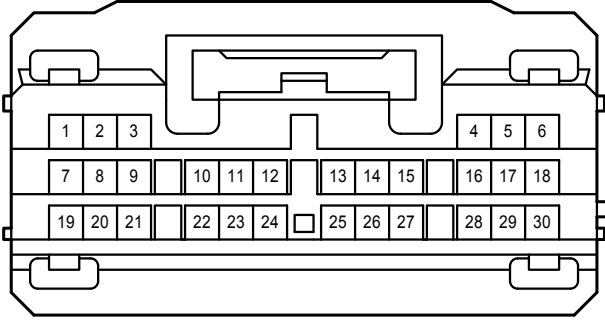

L 12  
Black

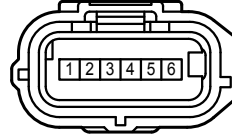

L 16  
Yellow

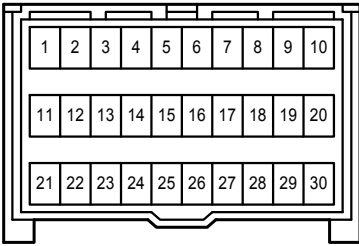

L 17  
White

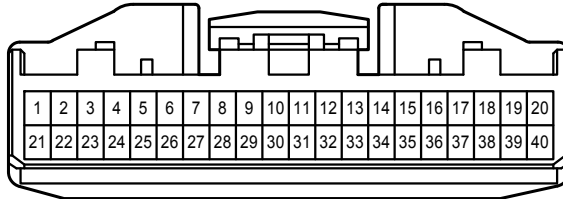

L 27  
White

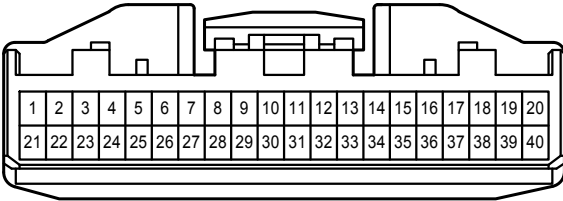

L 37  
White

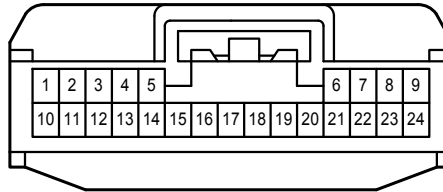

L 51  
White

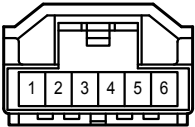

L 54  
White

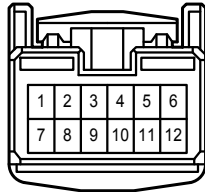

L 60  
White

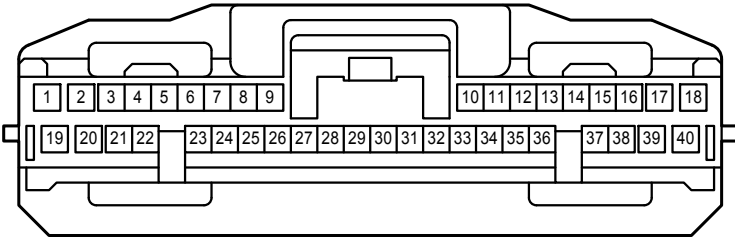

L 61  
White

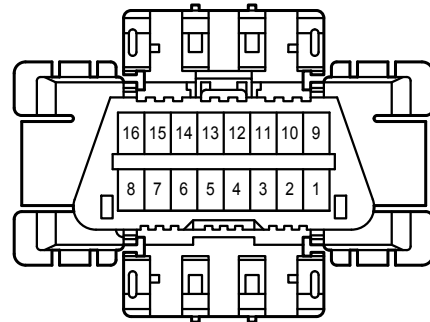

L 62  
White

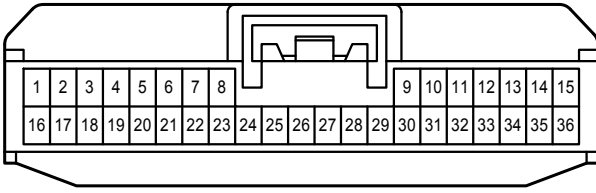

L 65  
White

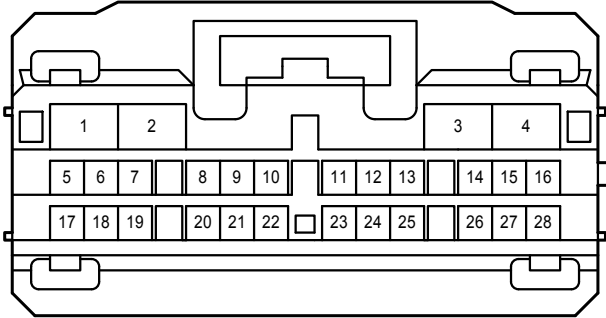

L 92  
White

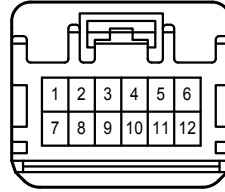

L 94  
White

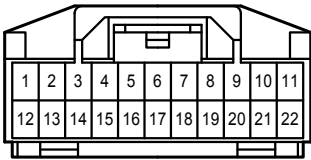

L 95  
White

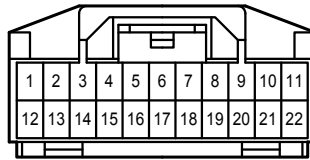

L 96  
White



L 97  
White

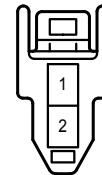

L 98  
White

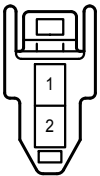

L 99  
White

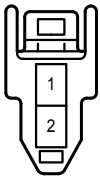

L100  
White

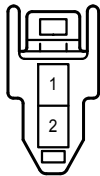

L101  
Black

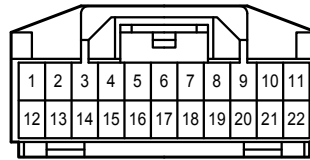

L102  
Blue

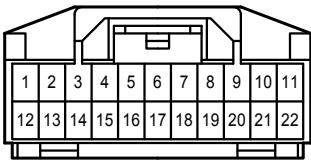

U 4  
White

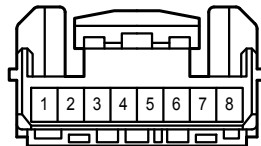

AL3  
White

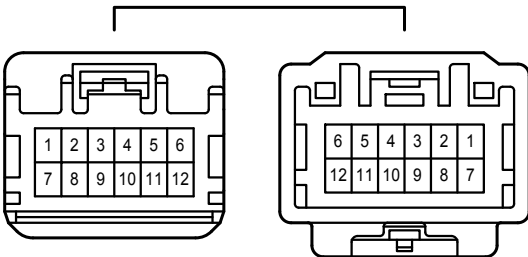

AL4  
Black

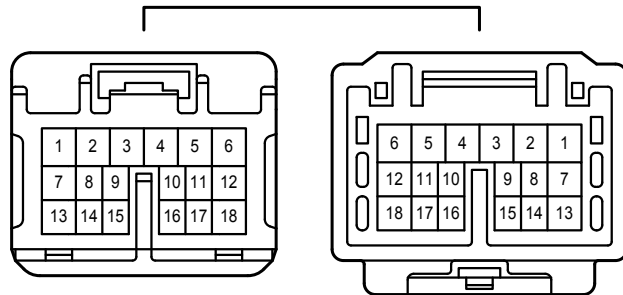

AL8  
White

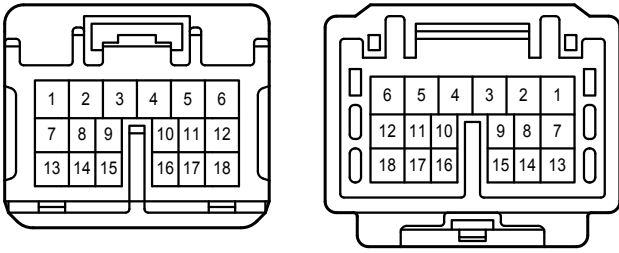

UL2  
White

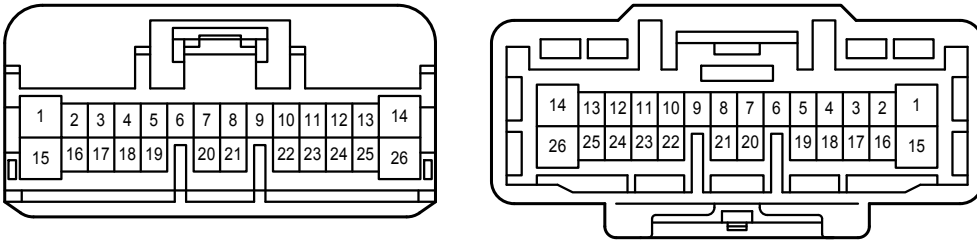

Power Outlet

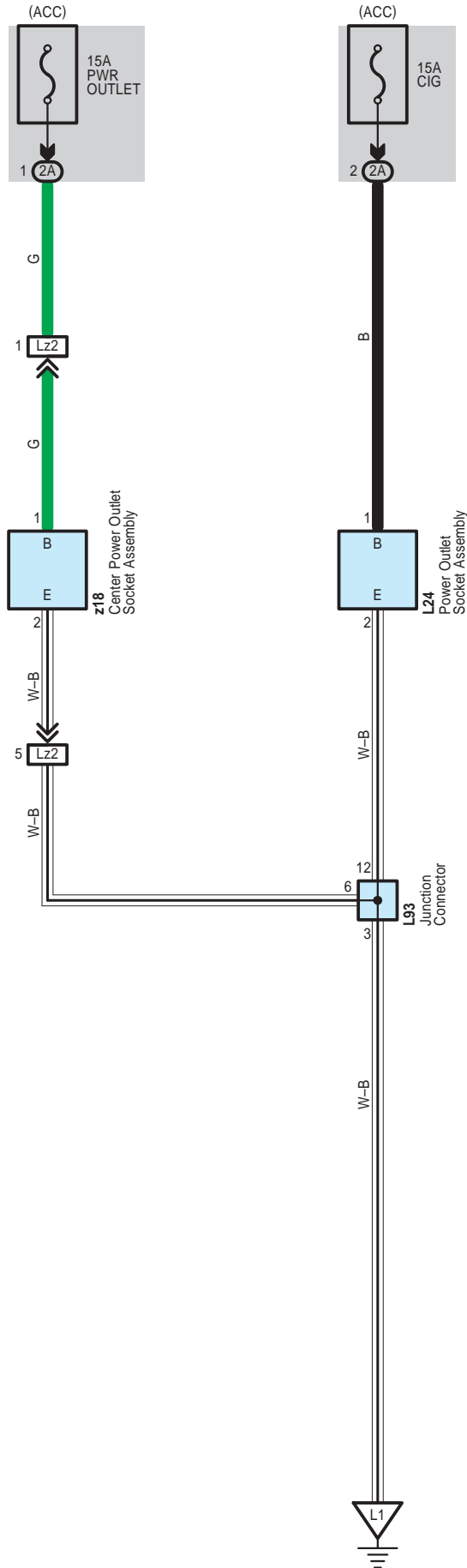

# Power Outlet

L 24

White

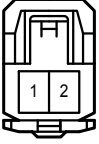

L 93

White

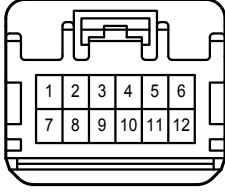

z 18

White

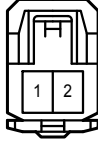

2A

White

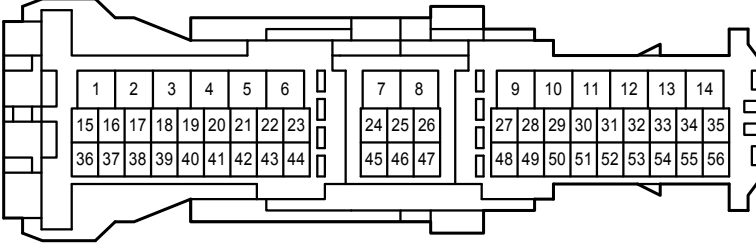

Lz2

White

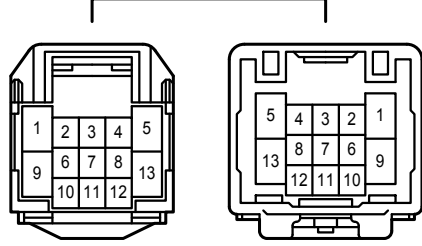

Power Seat

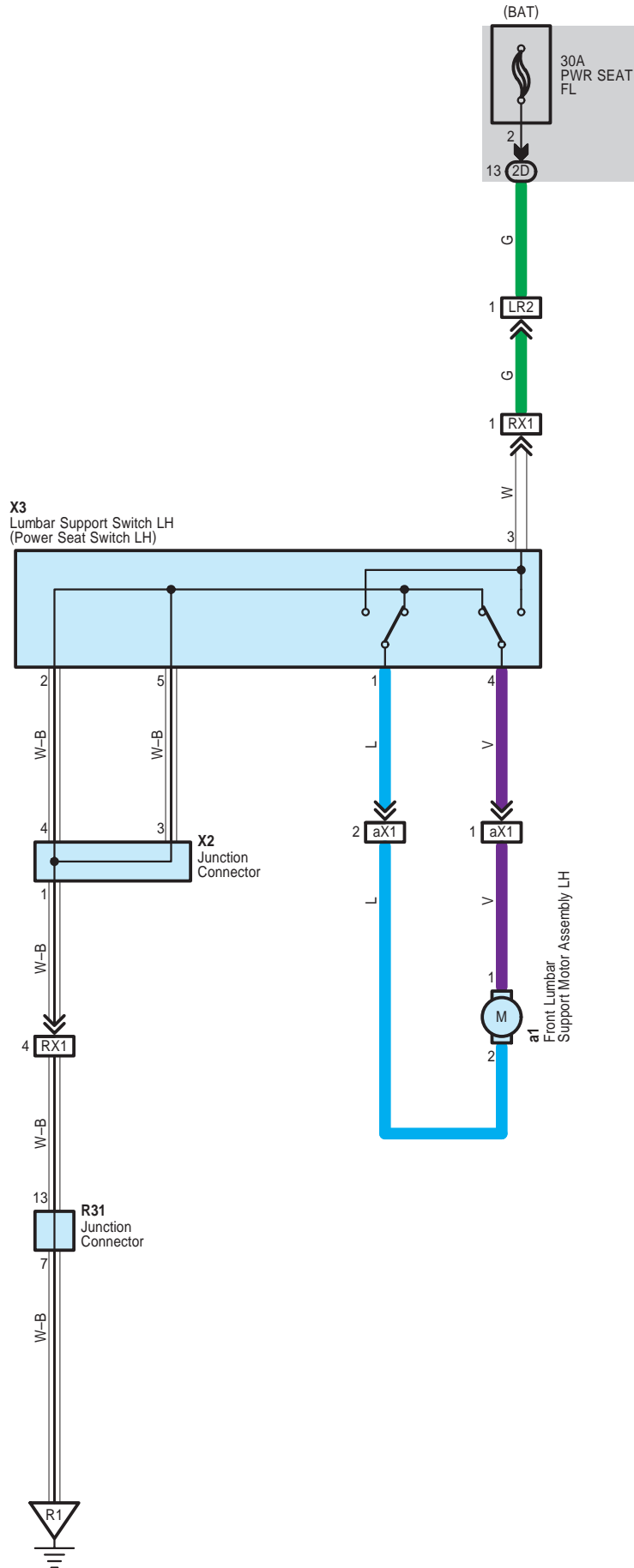

Power Seat

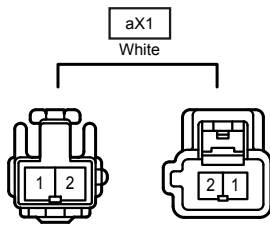
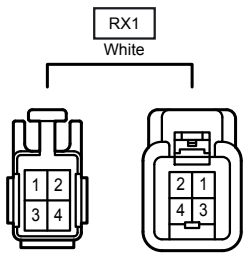
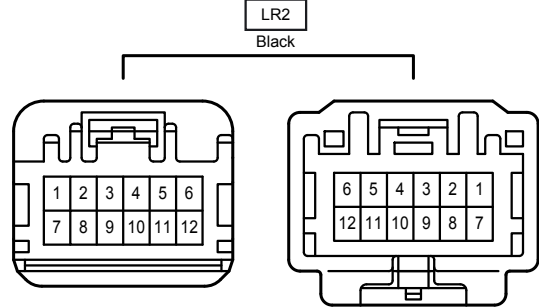
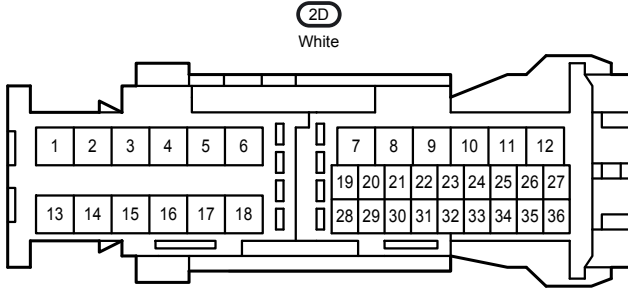
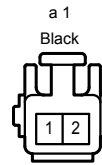
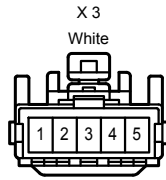
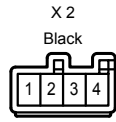
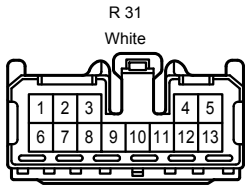



Power Source

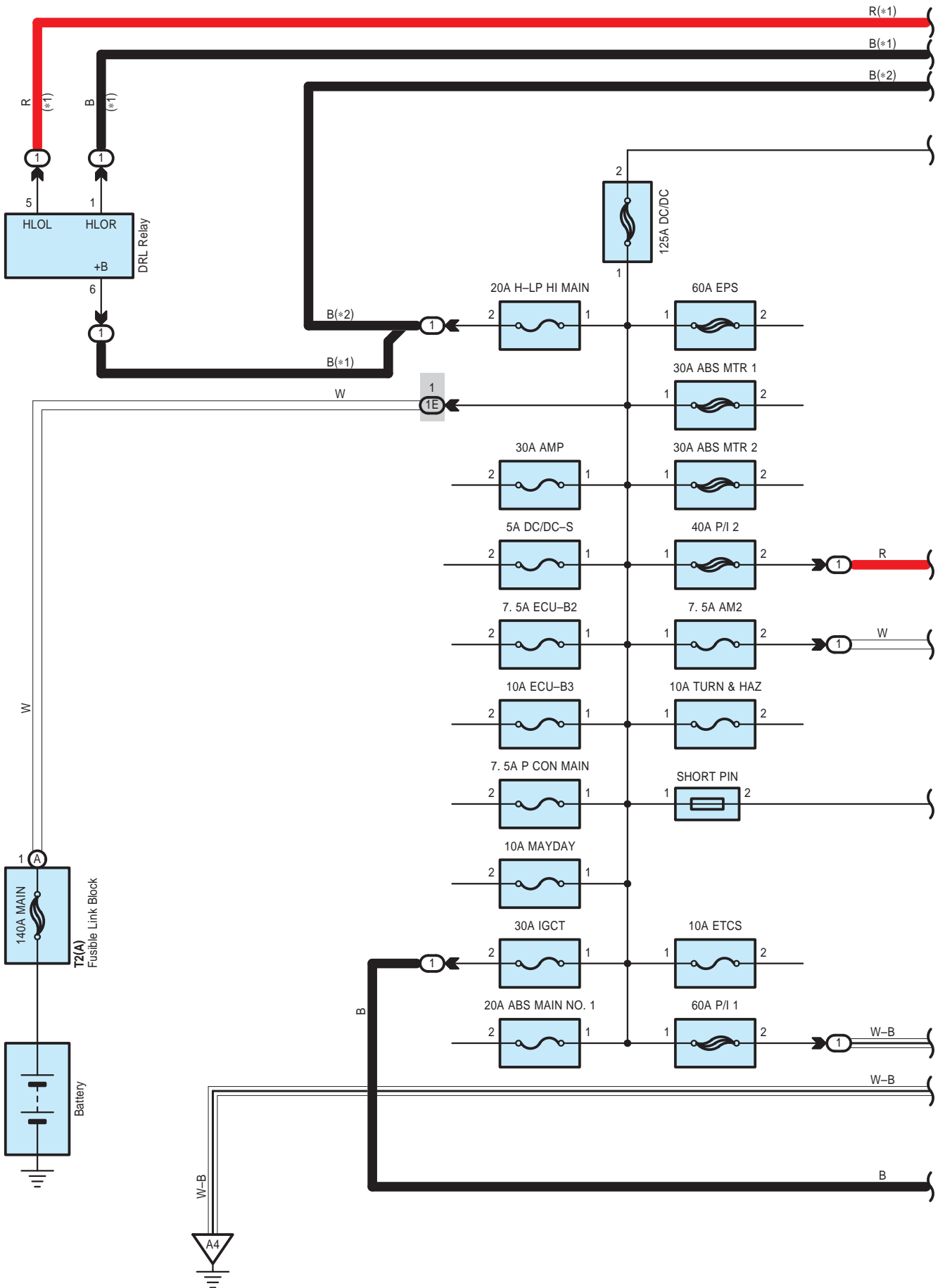





Power Source

- \* 1 : w/ Daytime Running Light
- \* 2 : w/o Daytime Running Light

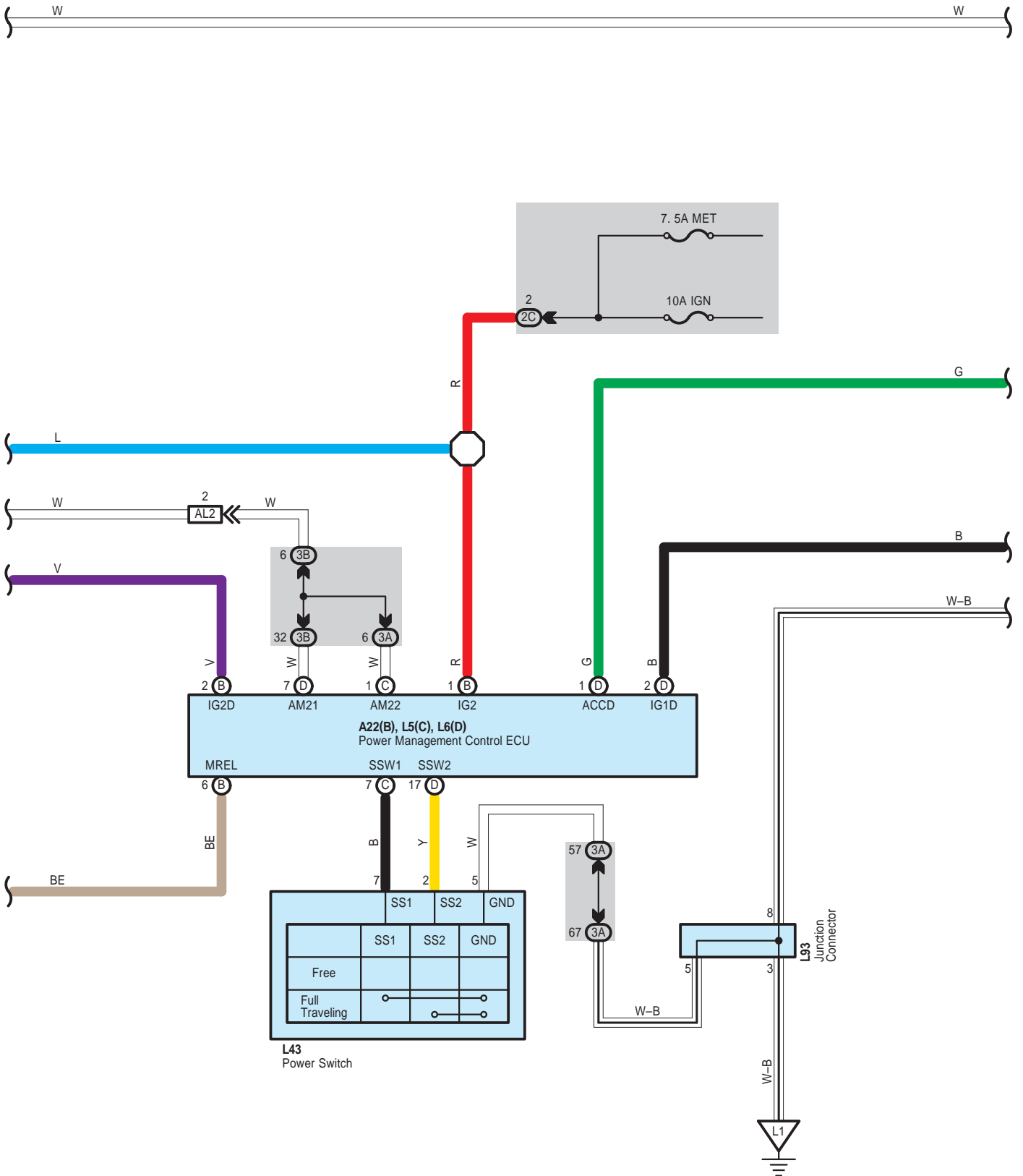

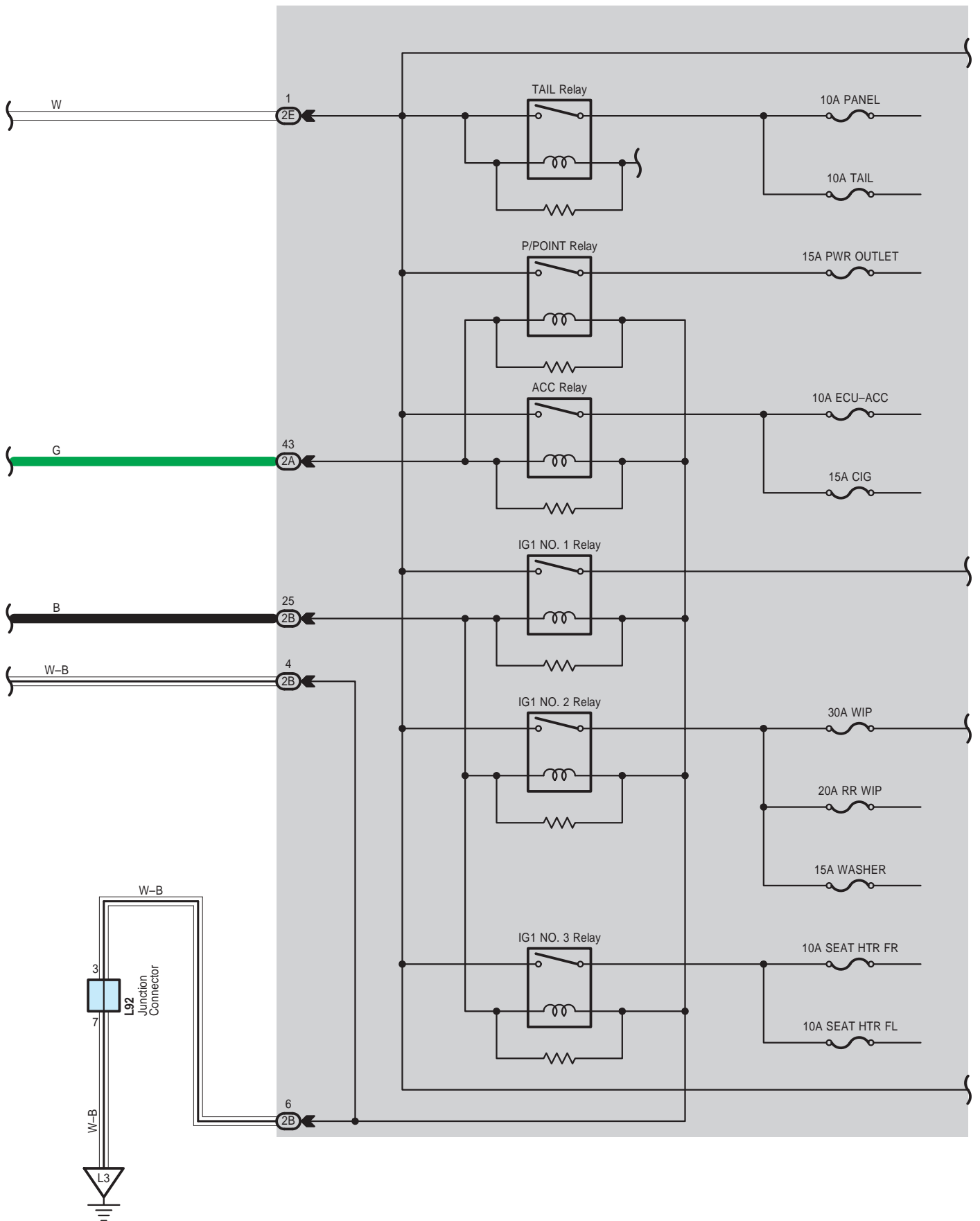





Power Source

2A

White

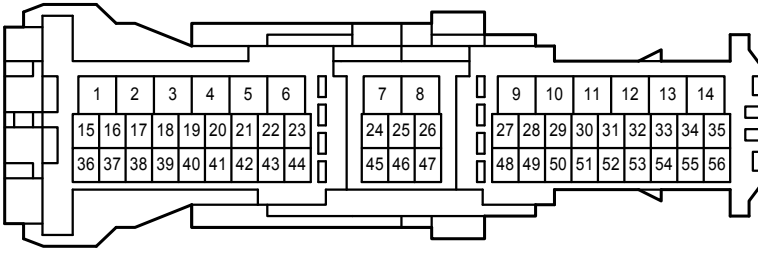

2B

White

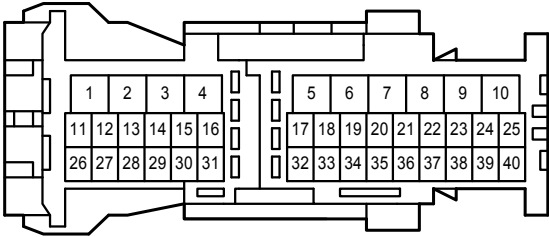

2C

White

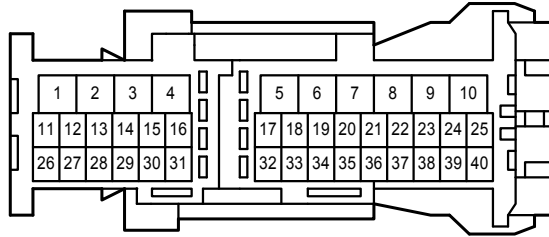

2E

White

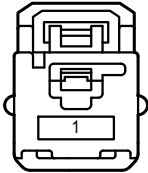

3A

White

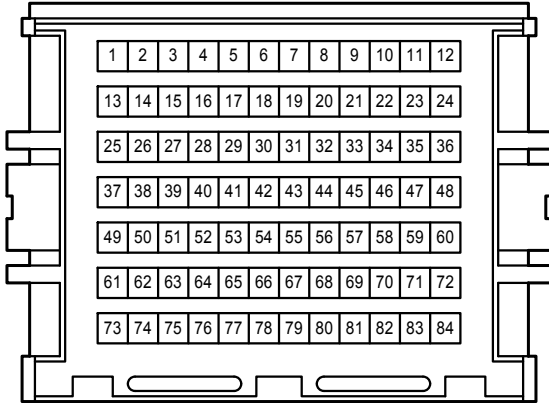

3B

White

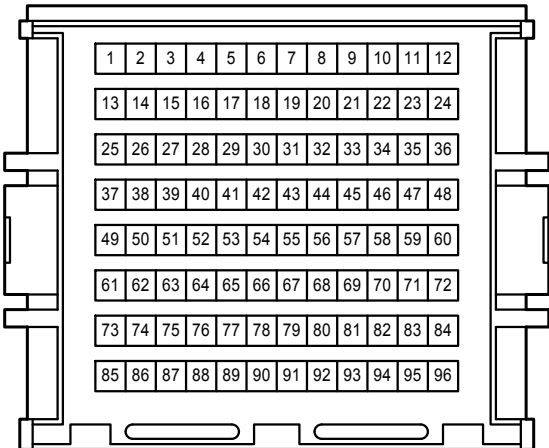

4A

White

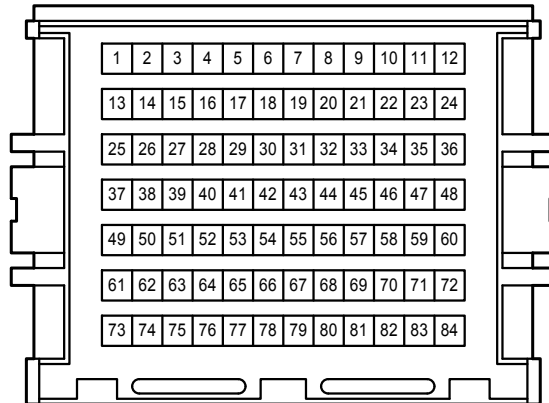



4B  
White

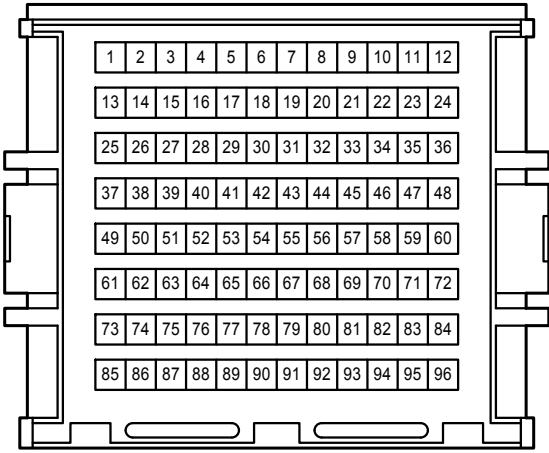

AL2  
Gray

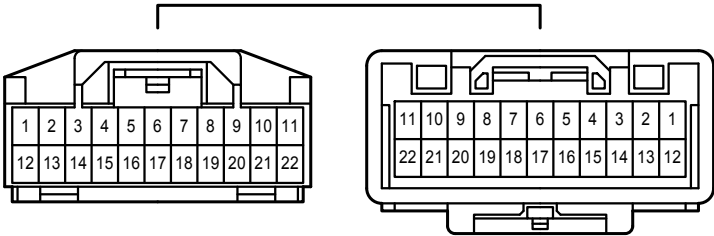

Power Window

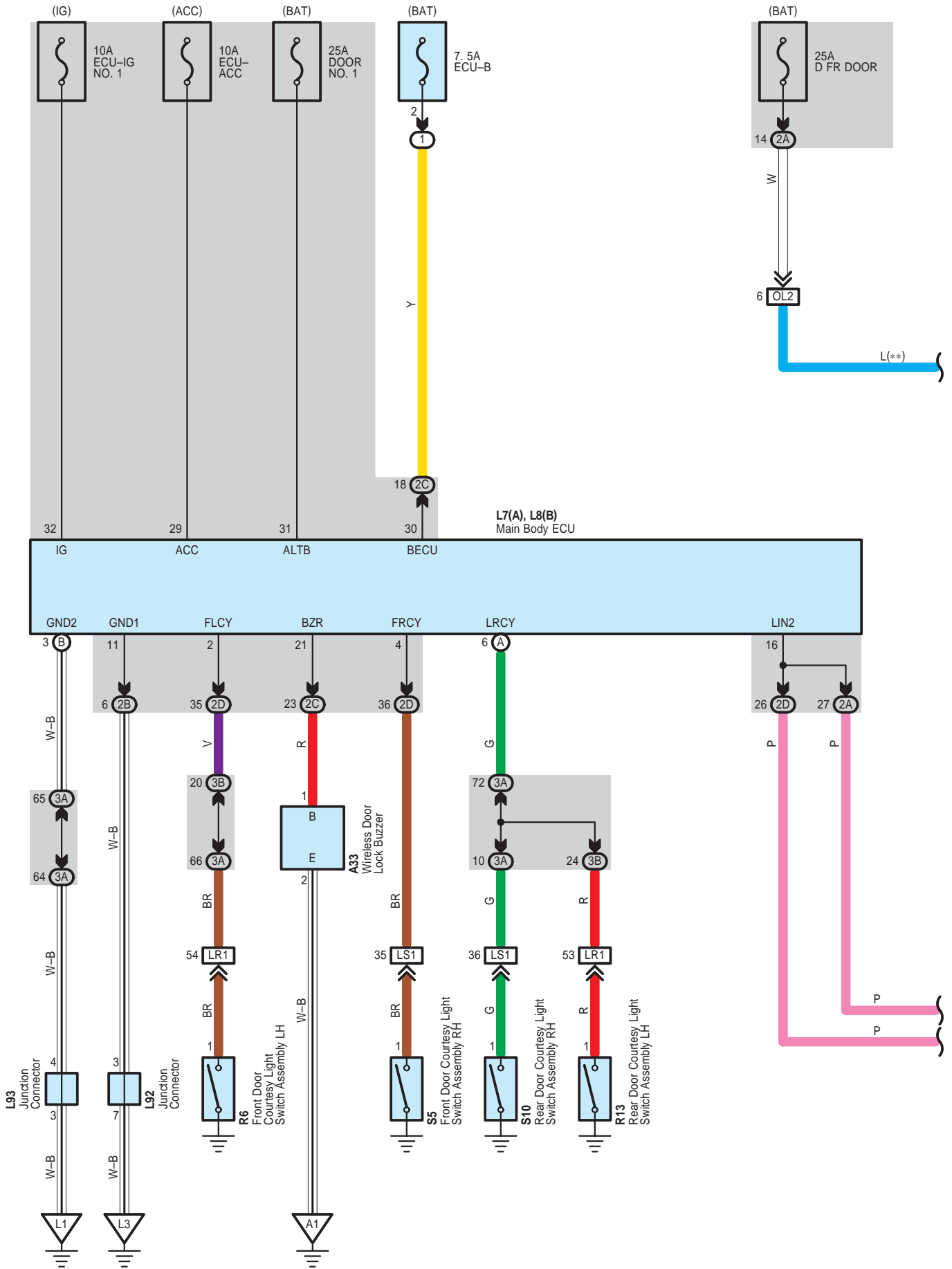

# Power Window

O2  
Front Power Window Regulator Motor Assembly LH

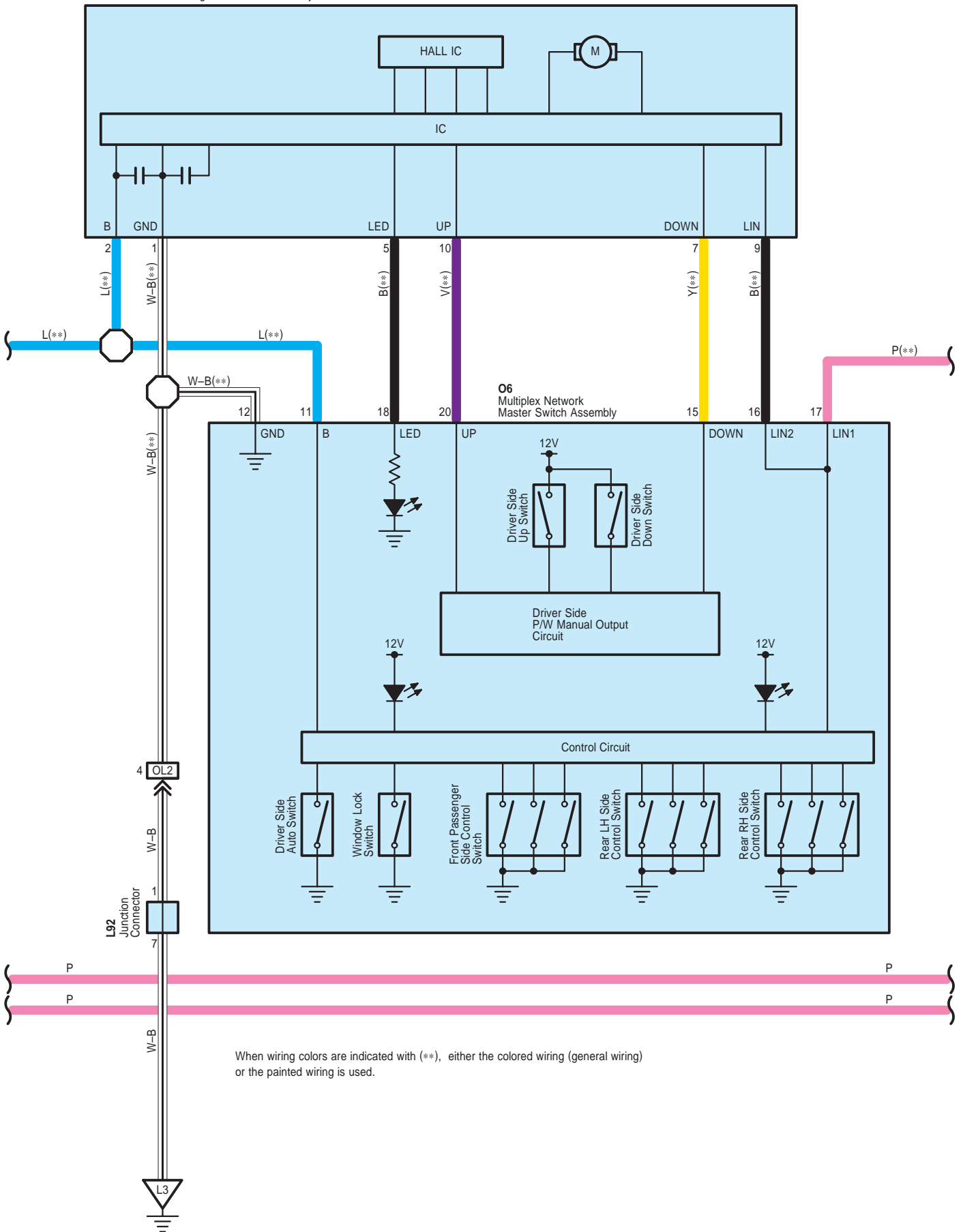

When wiring colors are indicated with (\*\*), either the colored wiring (general wiring) or the painted wiring is used.





When wiring colors are indicated with (\*\*), either the colored wiring (general wiring) or the painted wiring is used.

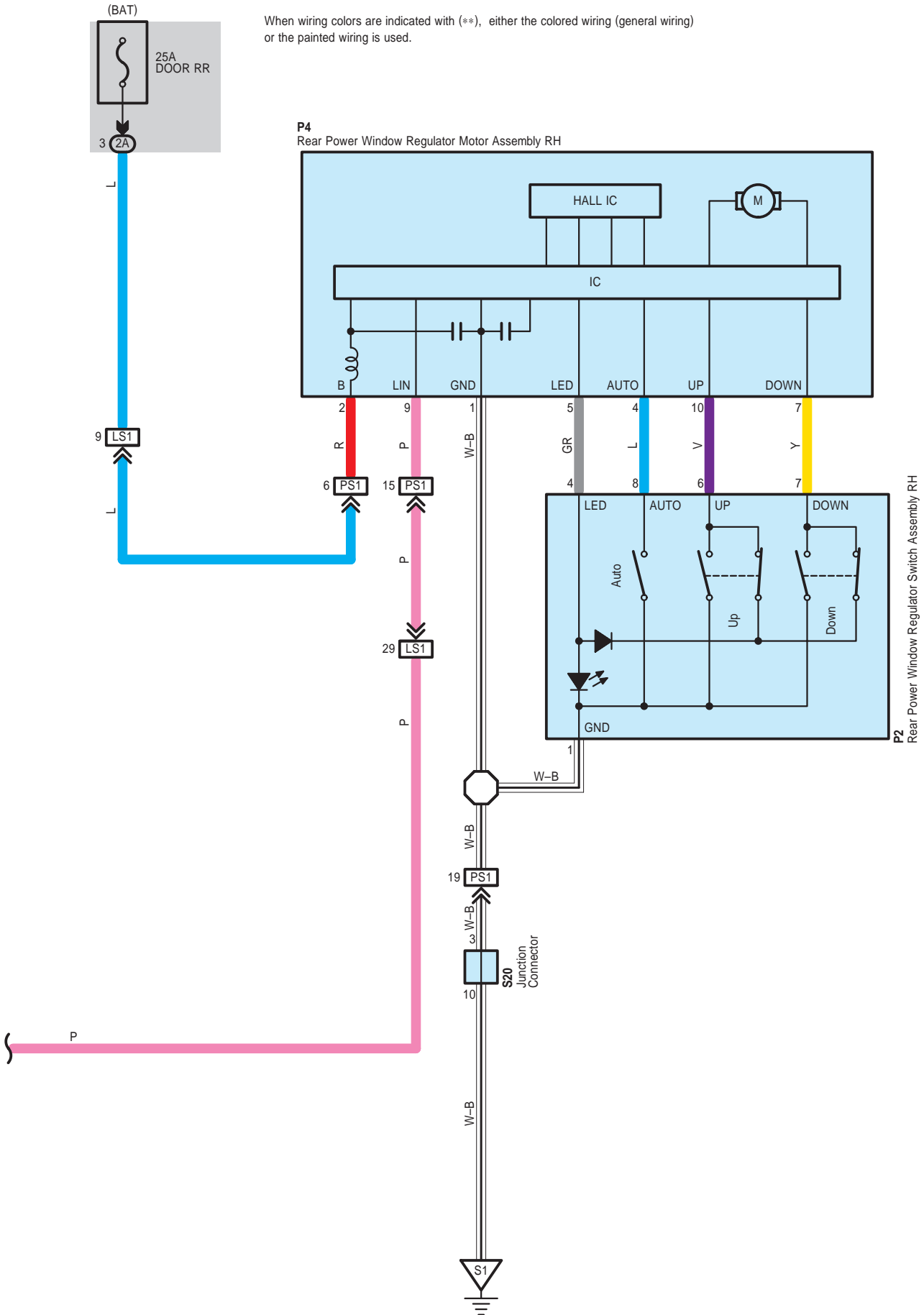

A 33  
Gray

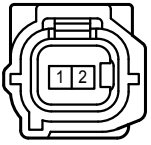

L 7  
White

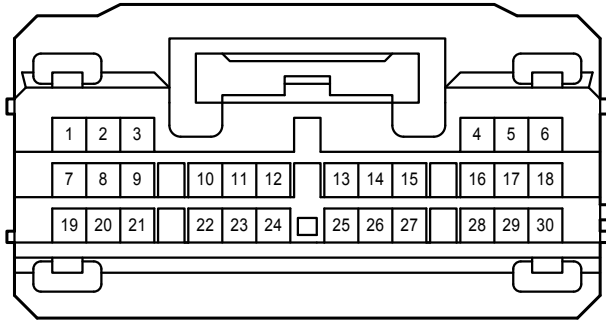

L 8  
White

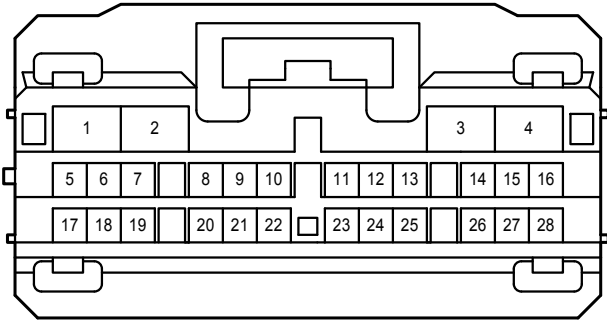

L 92  
White

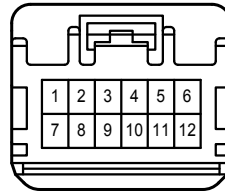

L 93  
White

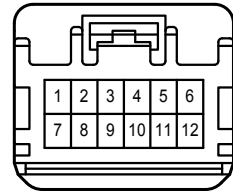

N 2  
White

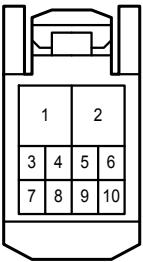

N 7  
White

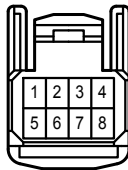

O 2  
White

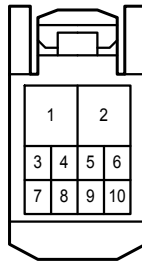

O 6  
White

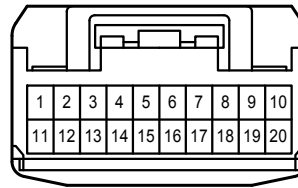

P 2  
White

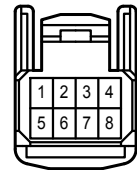

P 4  
White

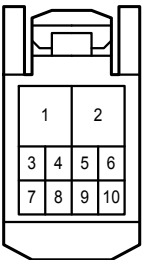

Q 2  
White

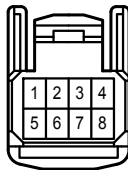

Q 4  
White

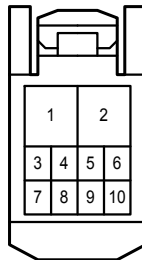

R 6  
Black



R 13  
Black



R 31  
White

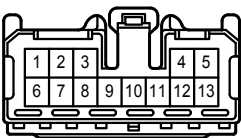

S 5  
Black



S 10  
Black



S 20  
White

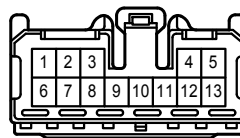

2A

White

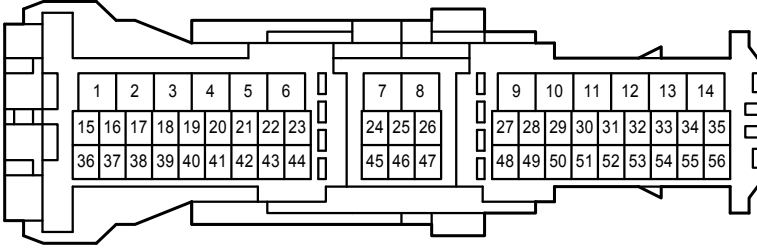

2B

White

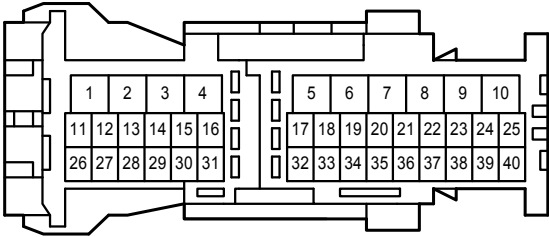

2C

White

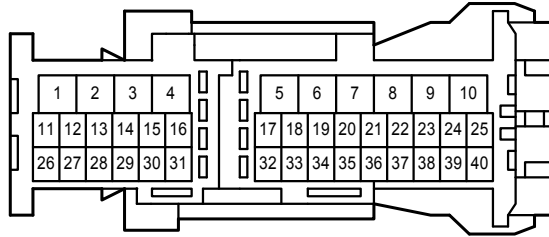

2D

White

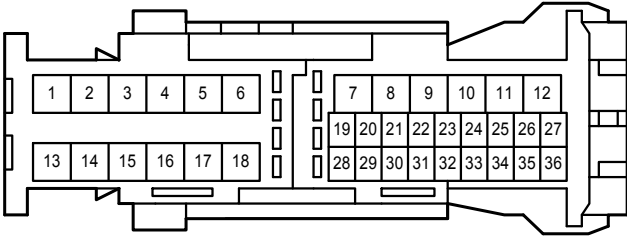

3A

White

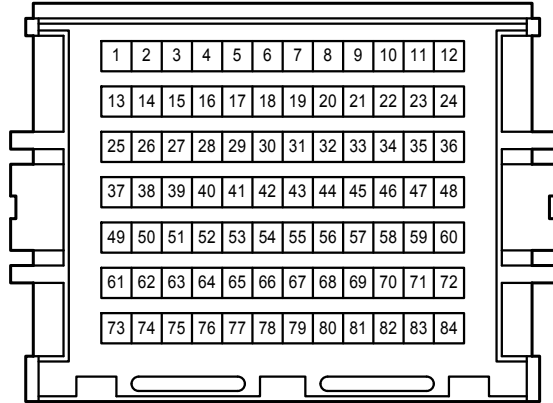

3B

White

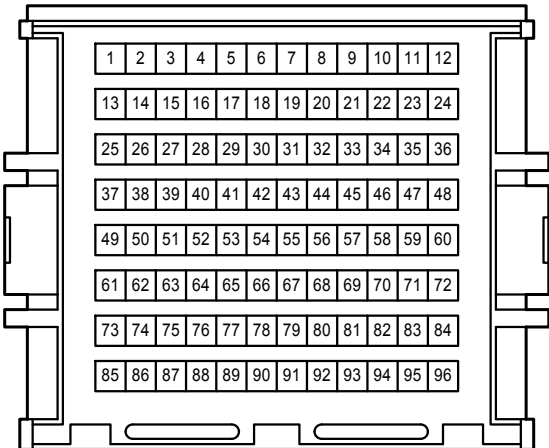



Power Window

LR1  
White

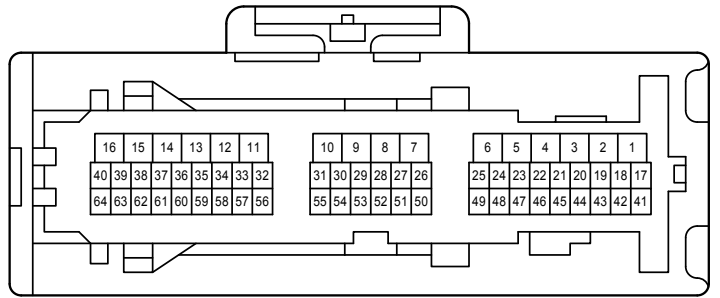
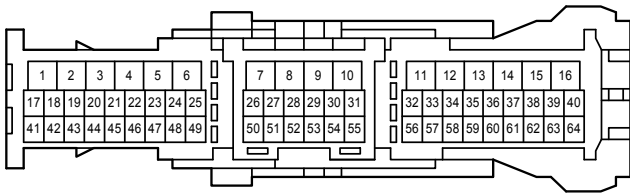

LR2  
Black

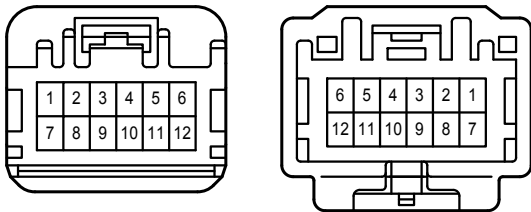

LS1  
White

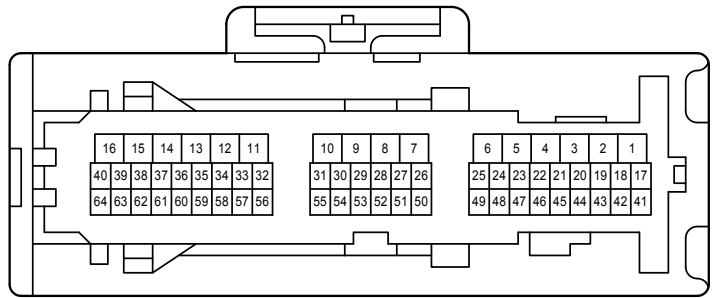
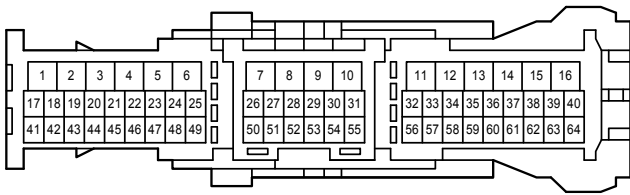

NL1  
White

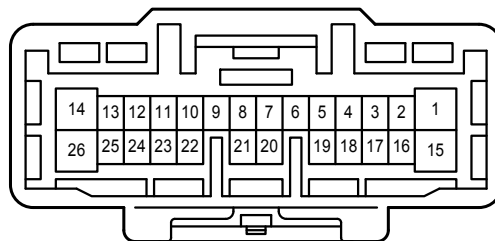
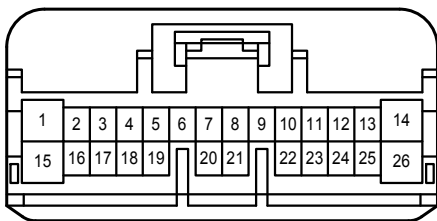

NL2  
White

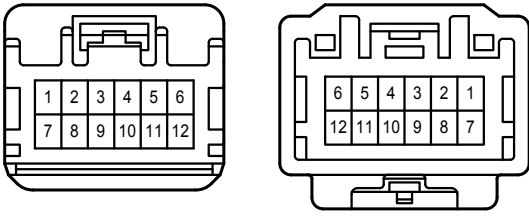

OL1  
White

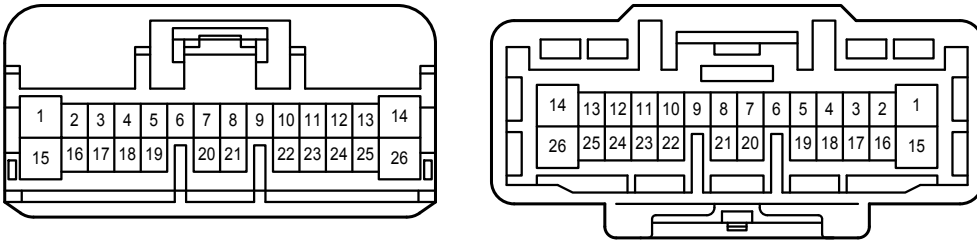

OL2  
White

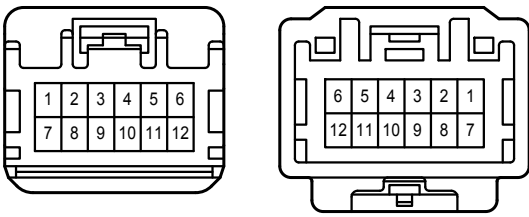

PS1  
White

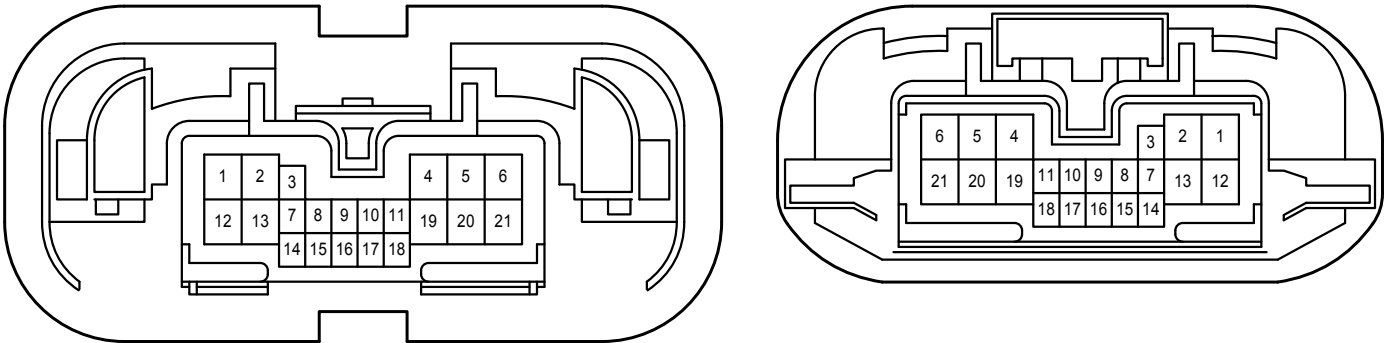

Power Window

QR1  
White

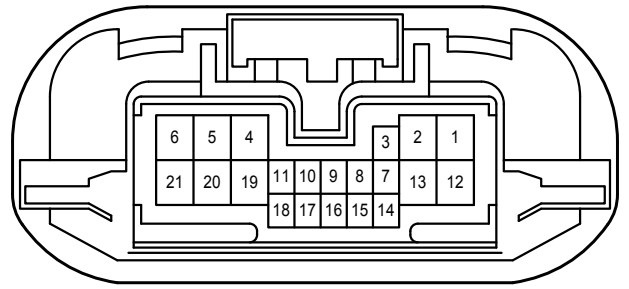
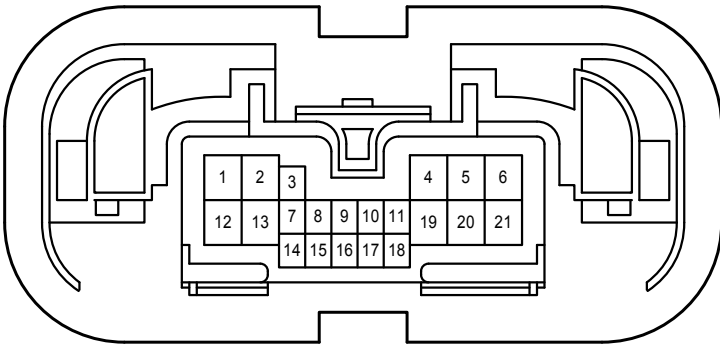

Pre-Collision System

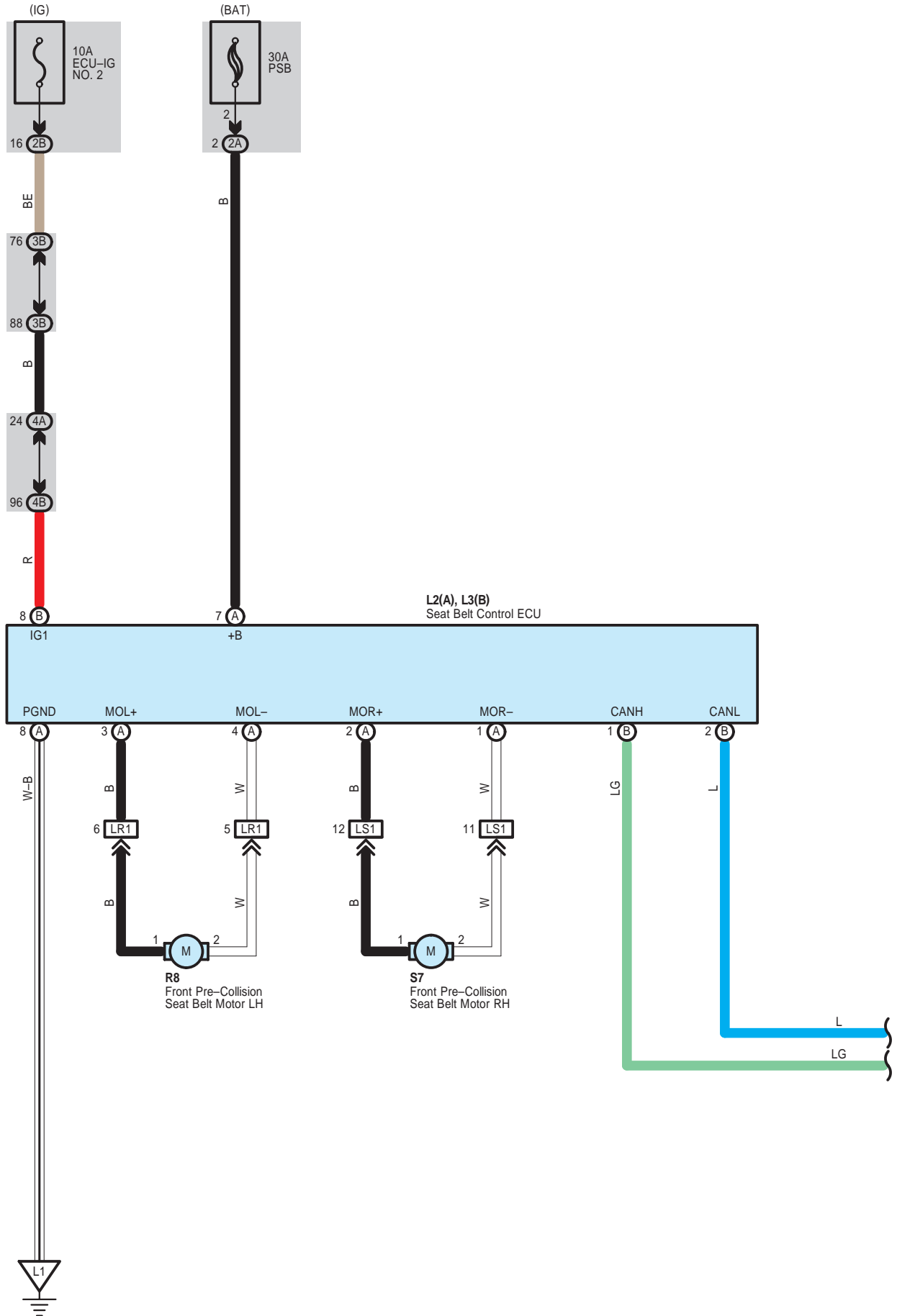

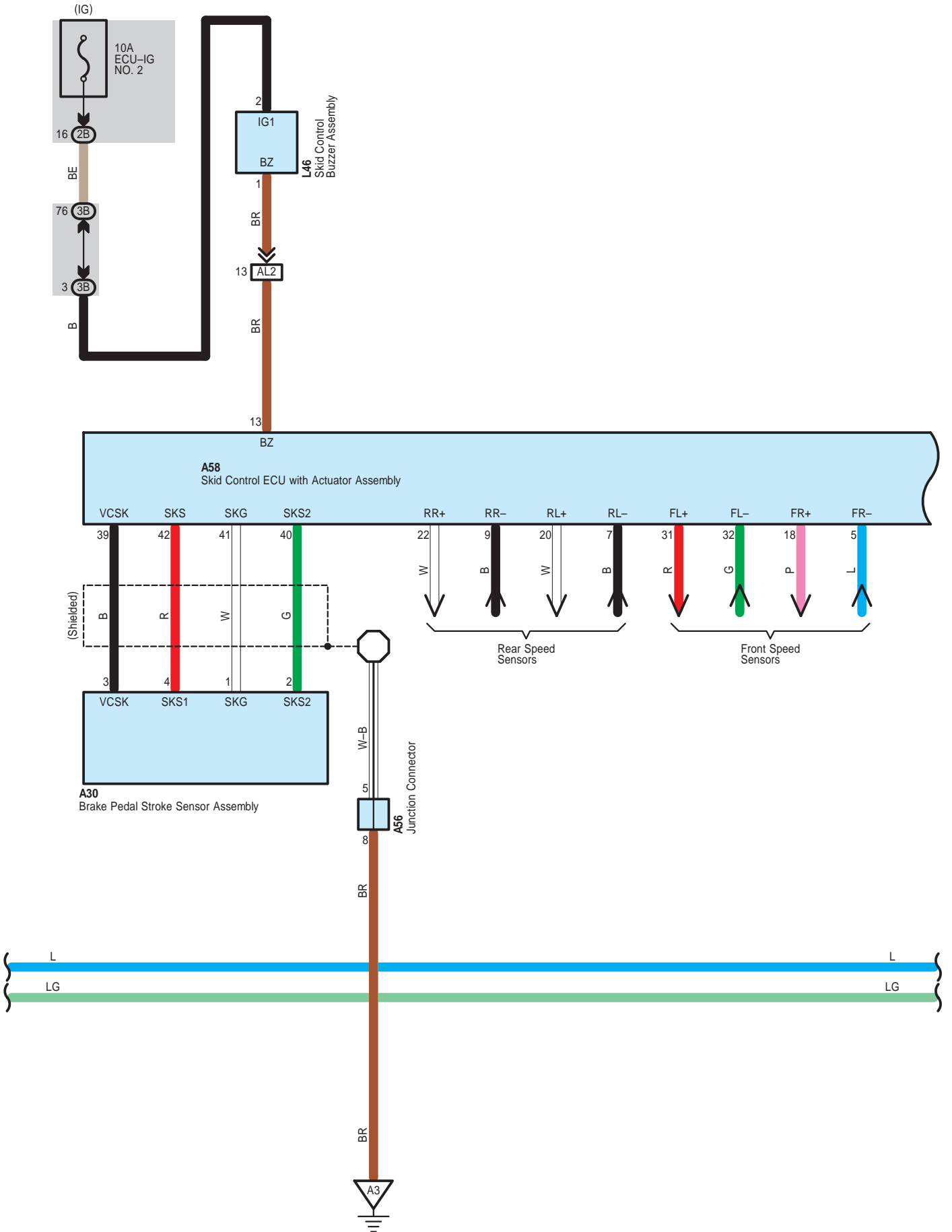

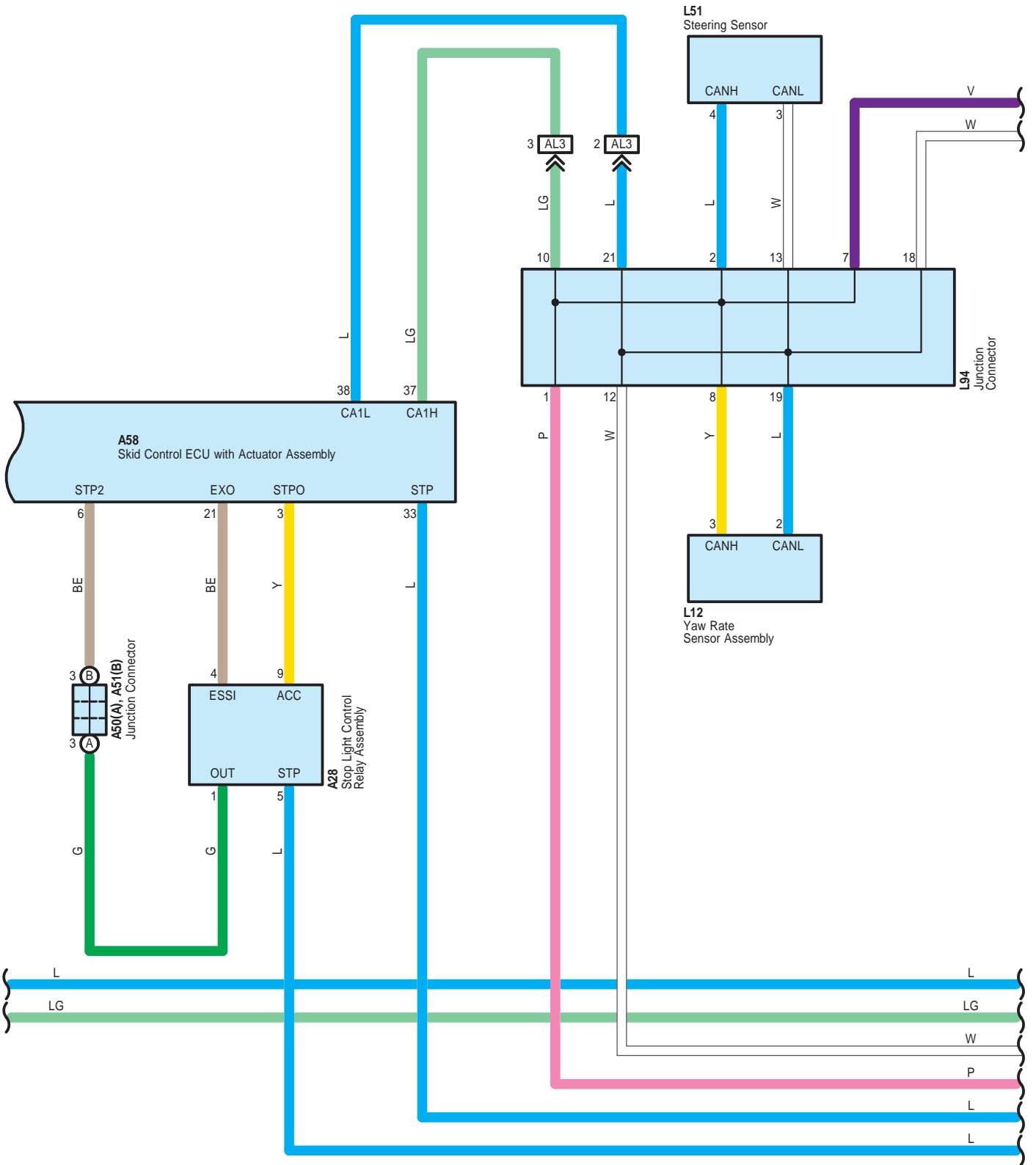

Pre-Collision System

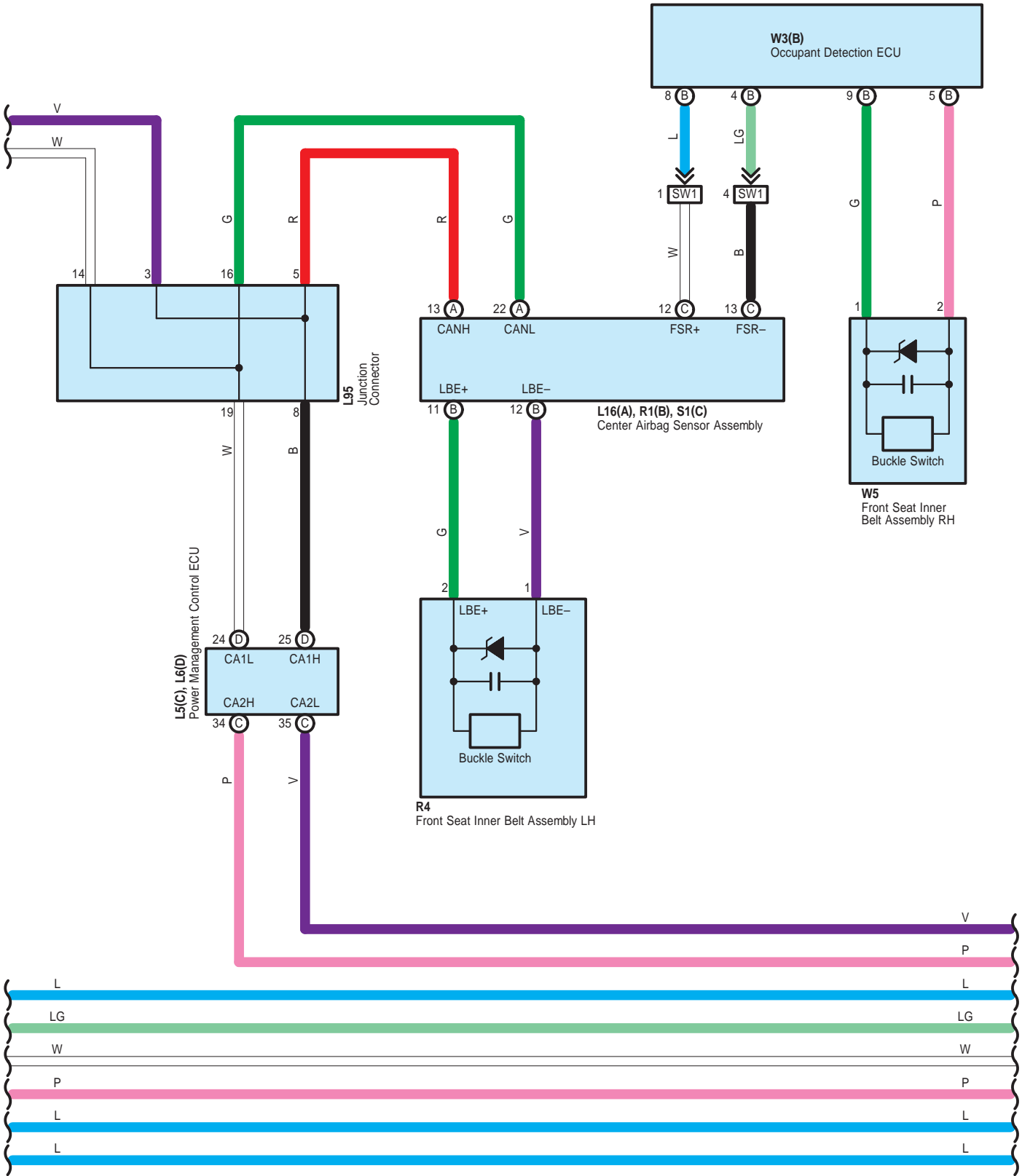

\* 1 : w/ Lane Keeping Assist

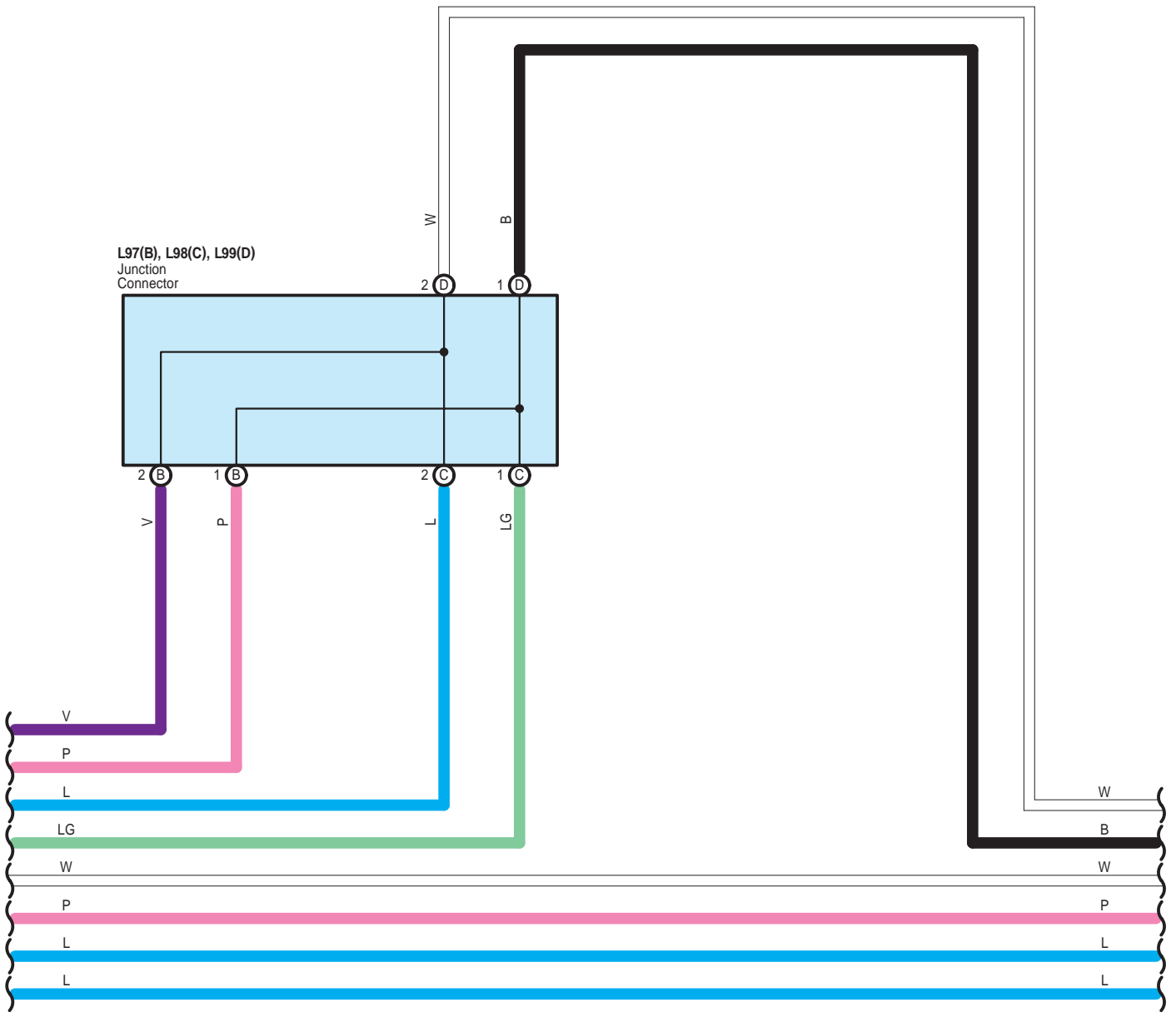



Pre-Collision System

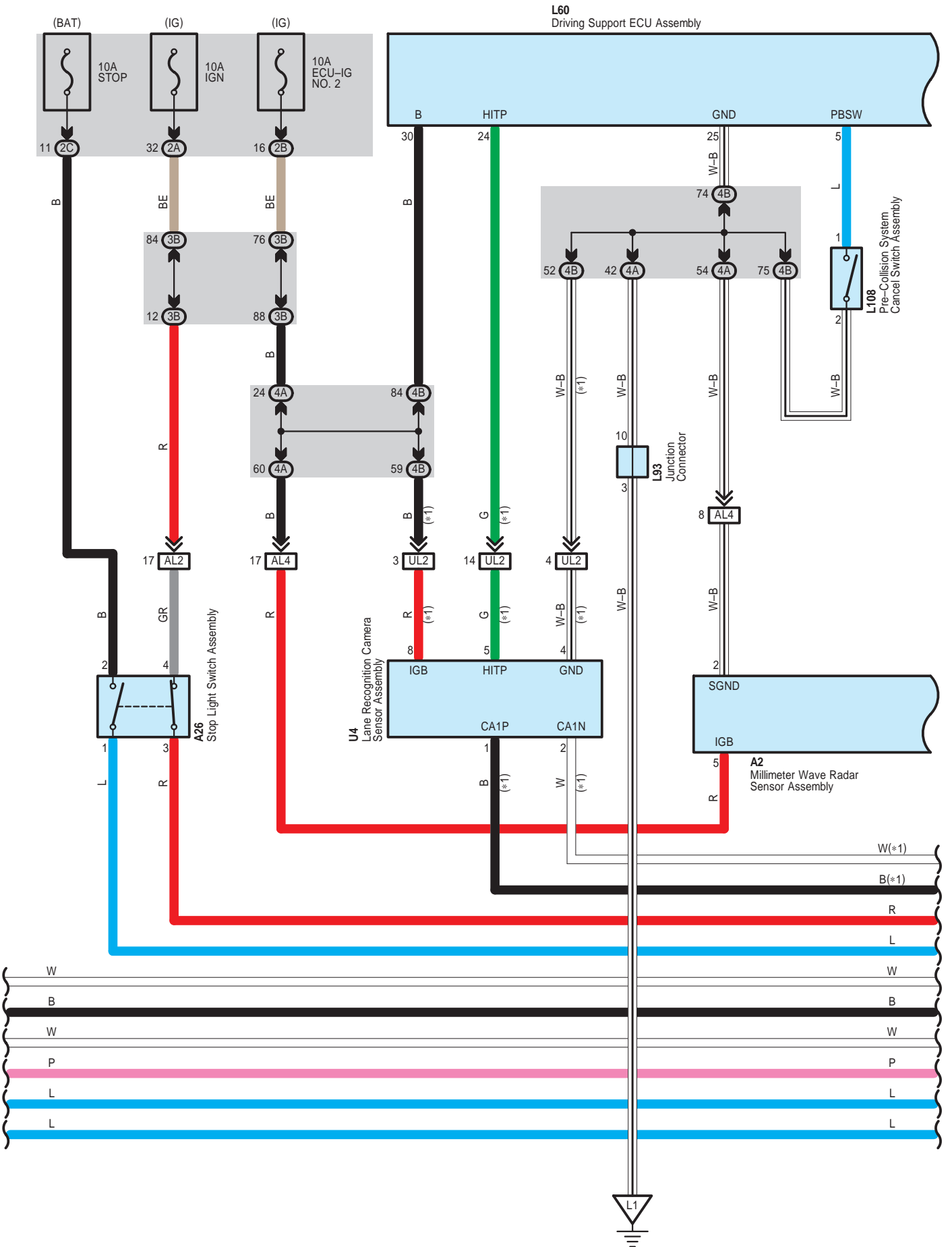

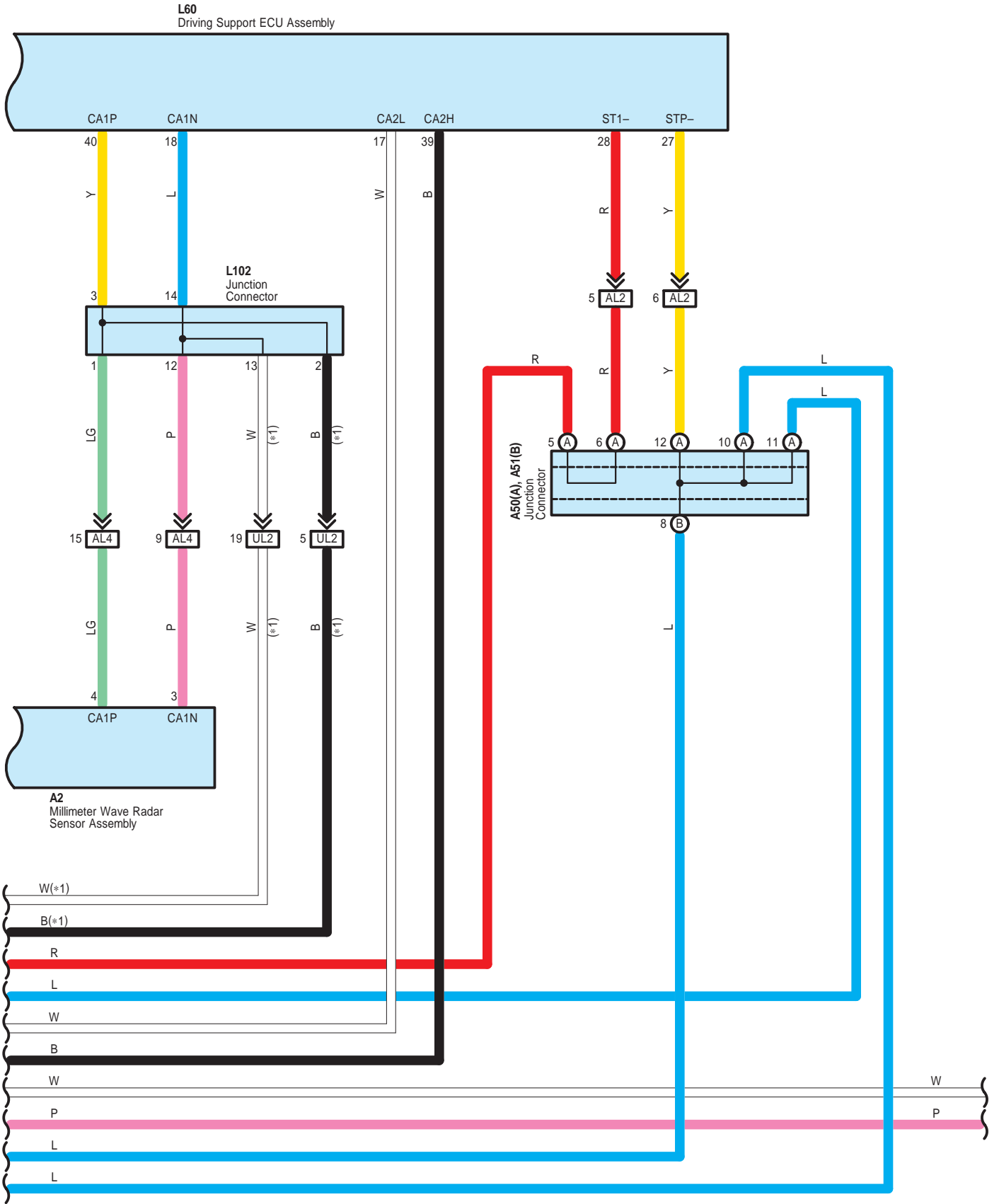



Pre-Collision System

A 2

Black



A 26

White

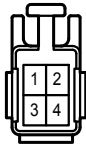

A 28

Black

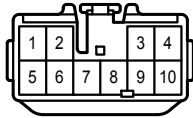

A 30

Black

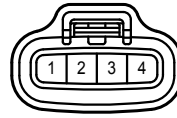

A 50

White

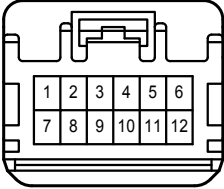

A 51

White

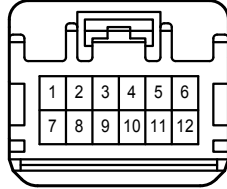

A 56

White

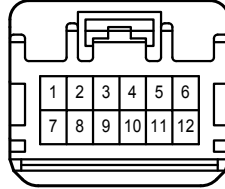

A 58

Gray

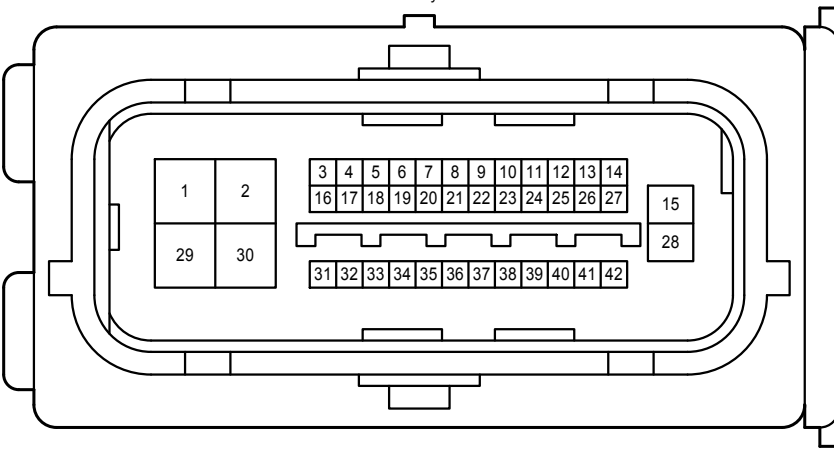

L 2

White

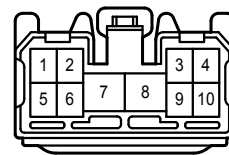

L 3

White

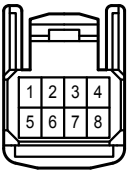

L 5

Gray

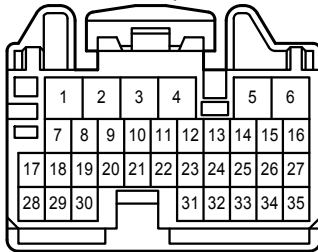

L 6

Gray

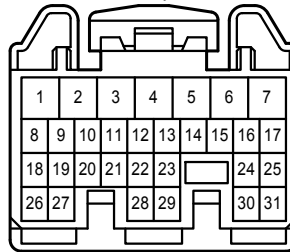

L 12

Black

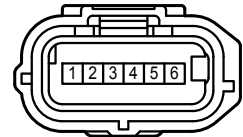

L 16

Yellow

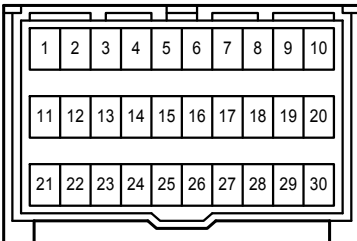

L 27

White

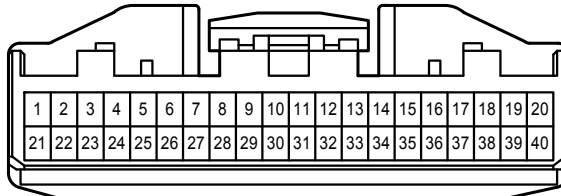

L 46

Blue

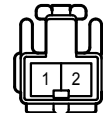

Pre-Collision System

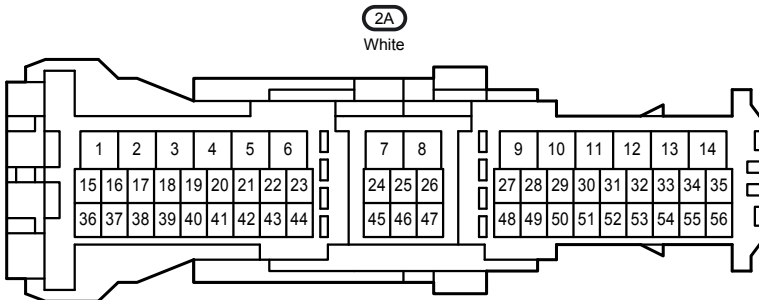
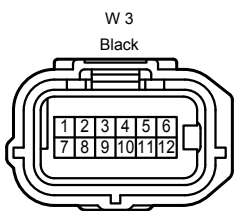
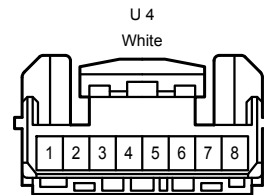
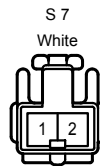
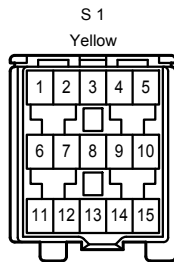
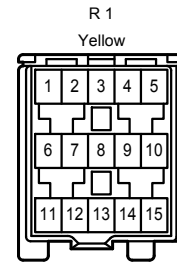
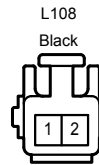
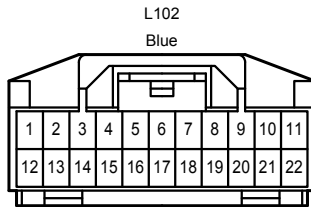
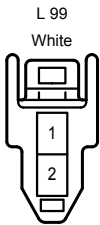
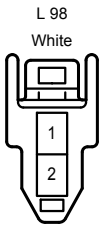
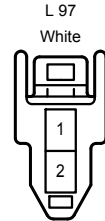
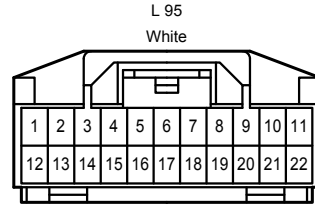
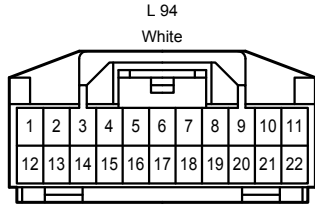
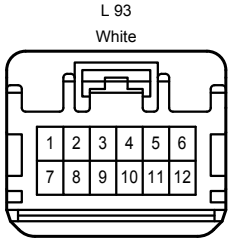
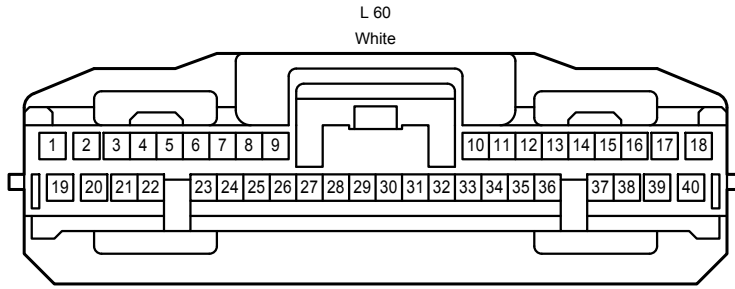
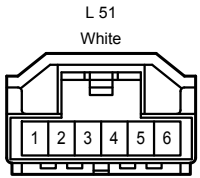

Pre-Collision System

2B

White

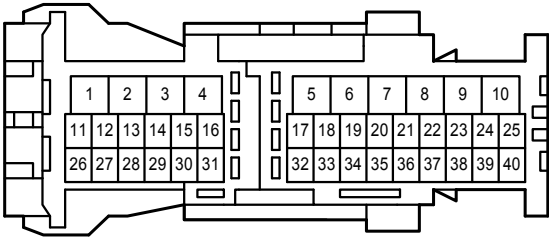

2C

White

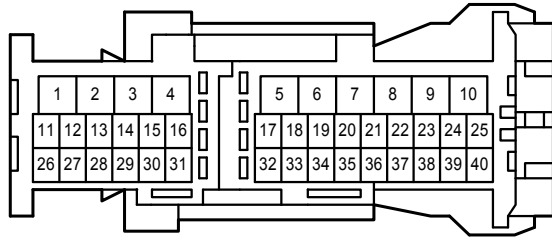

3B

White

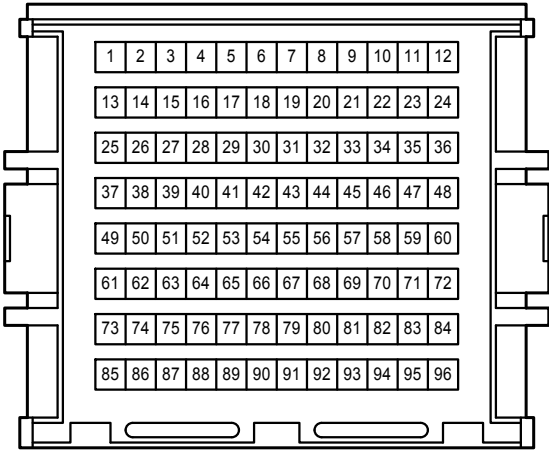

4A

White

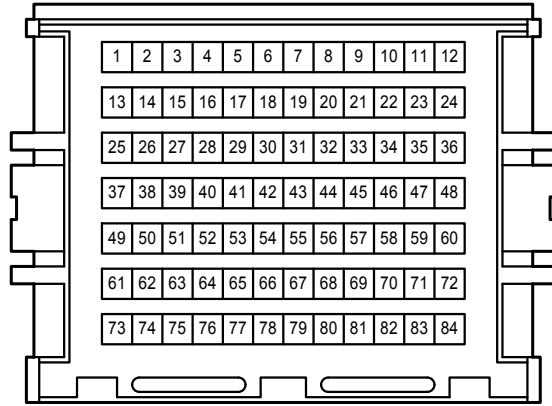

4B

White

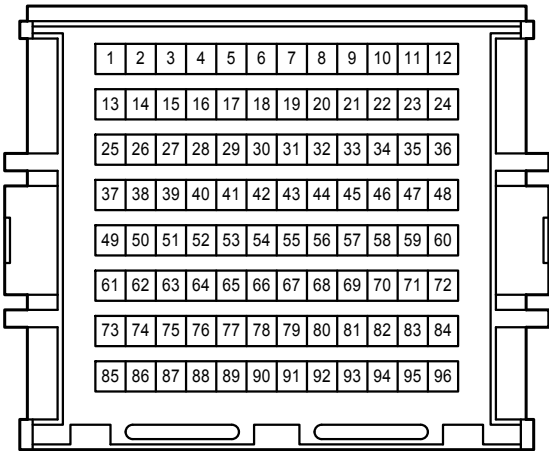

AL2

Gray

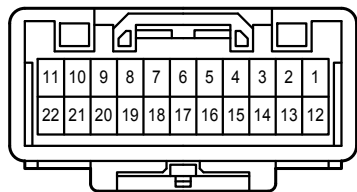
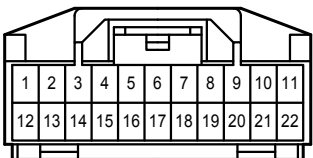

Pre-Collision System

AL3  
White

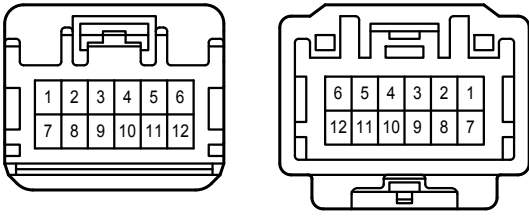

AL4  
Black

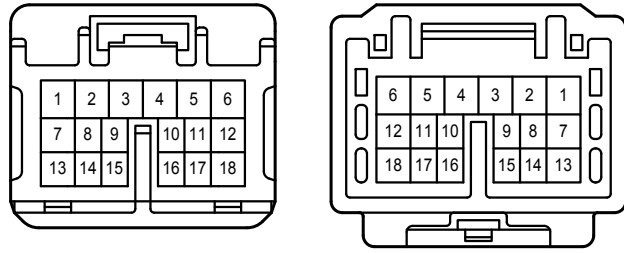

LR1  
White

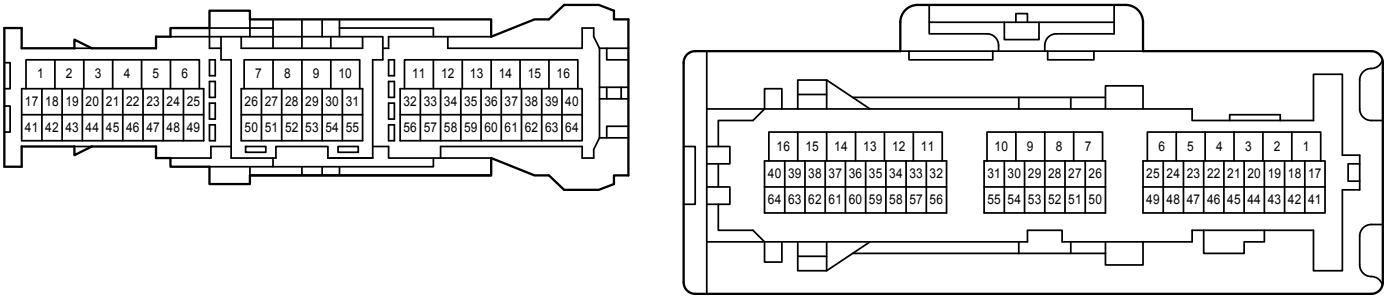

LS1  
White

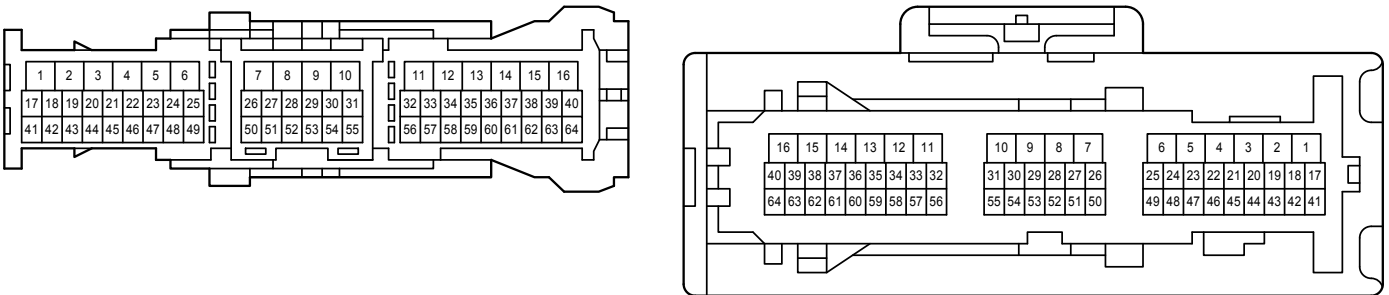

SW1  
Gray

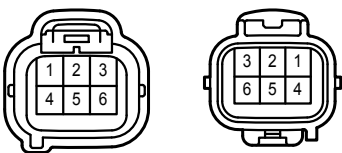

UL2  
White

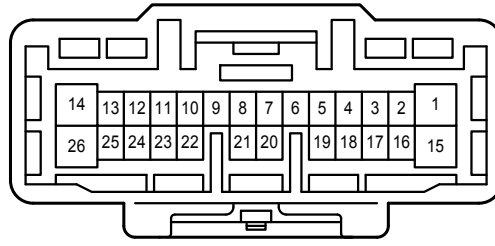
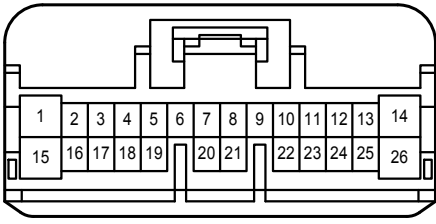





# Rear Wiper and Washer

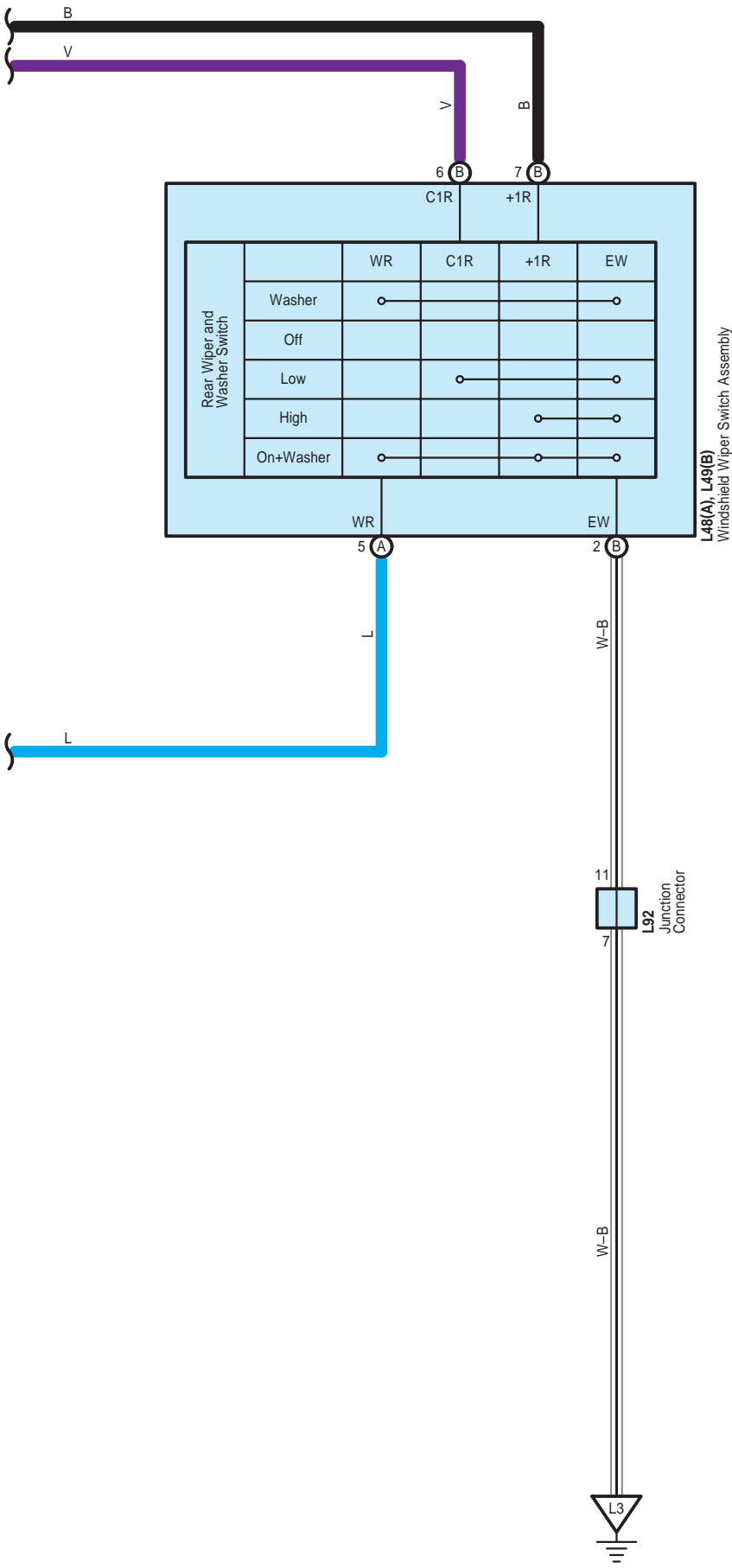

Rear Wiper and Washer

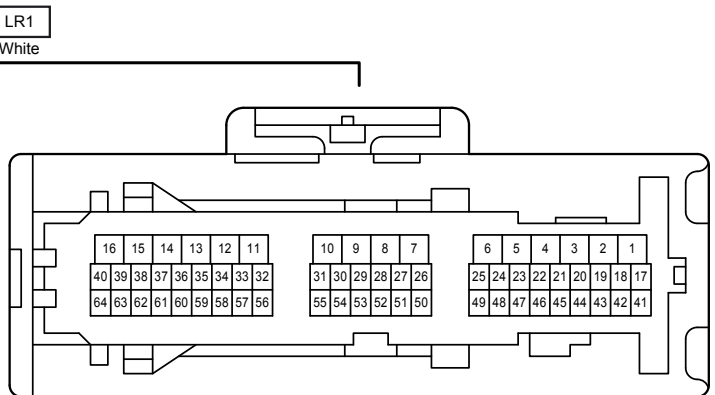
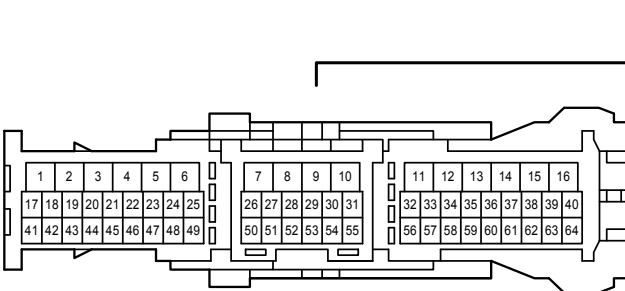
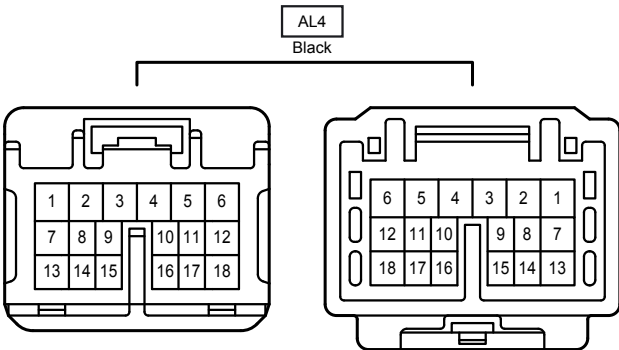
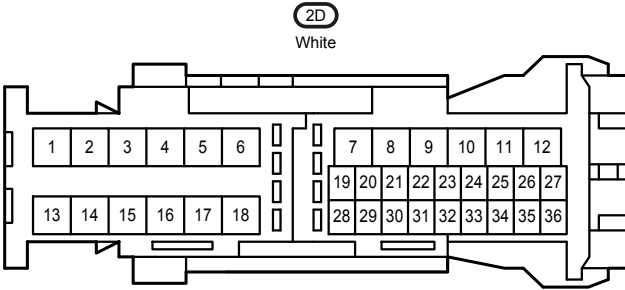
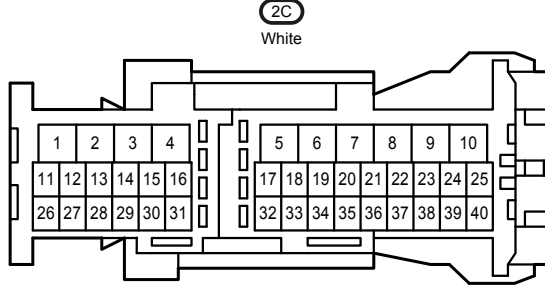
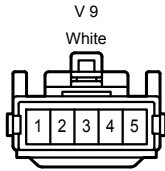
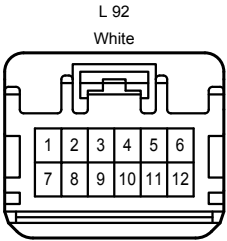
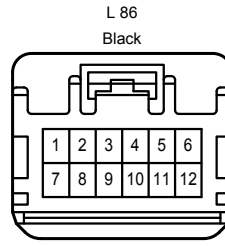
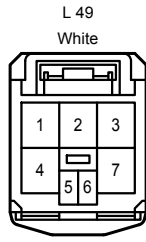
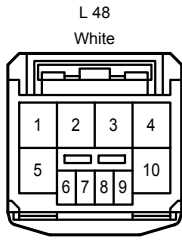
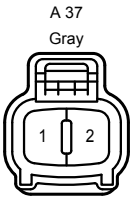

LR2  
Black

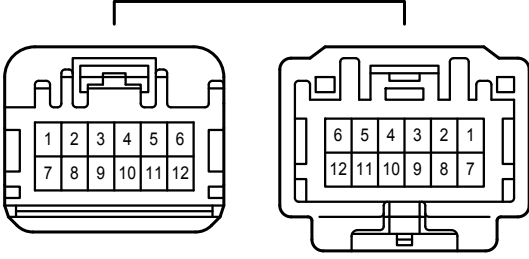

VR1  
White

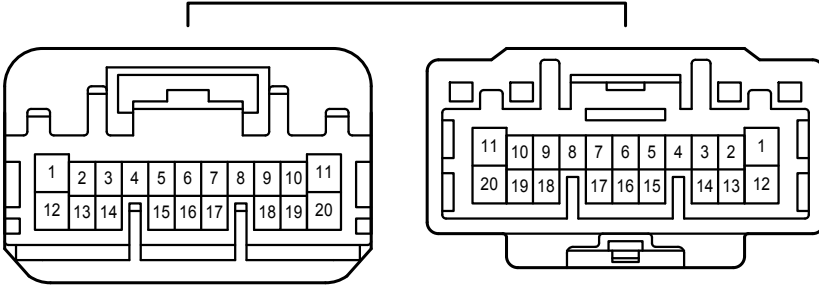

# Remote Air Conditioning System

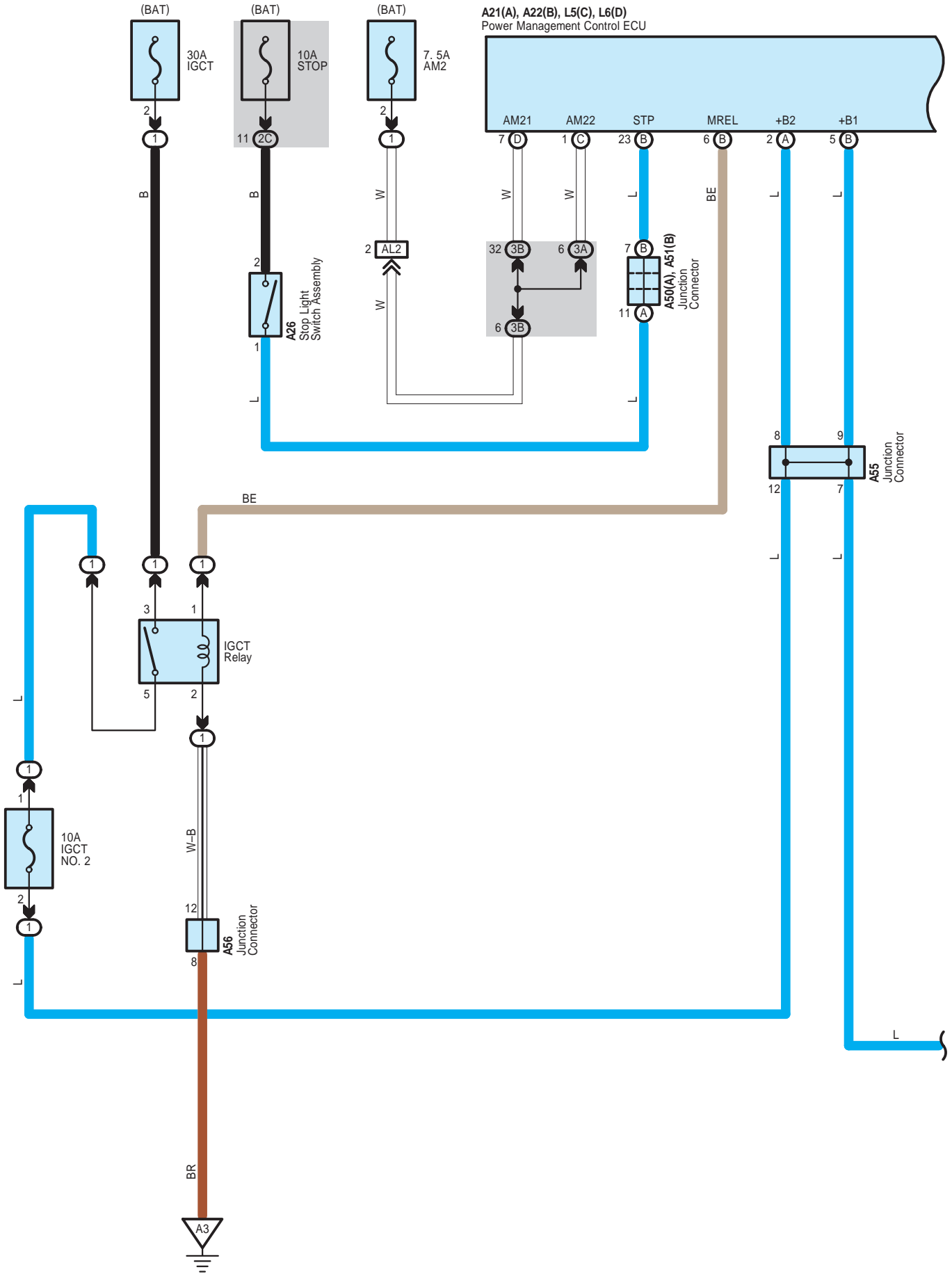

# Remote Air Conditioning System

A21(A), A22(B), L5(C), L6(D)  
Power Management Control ECU

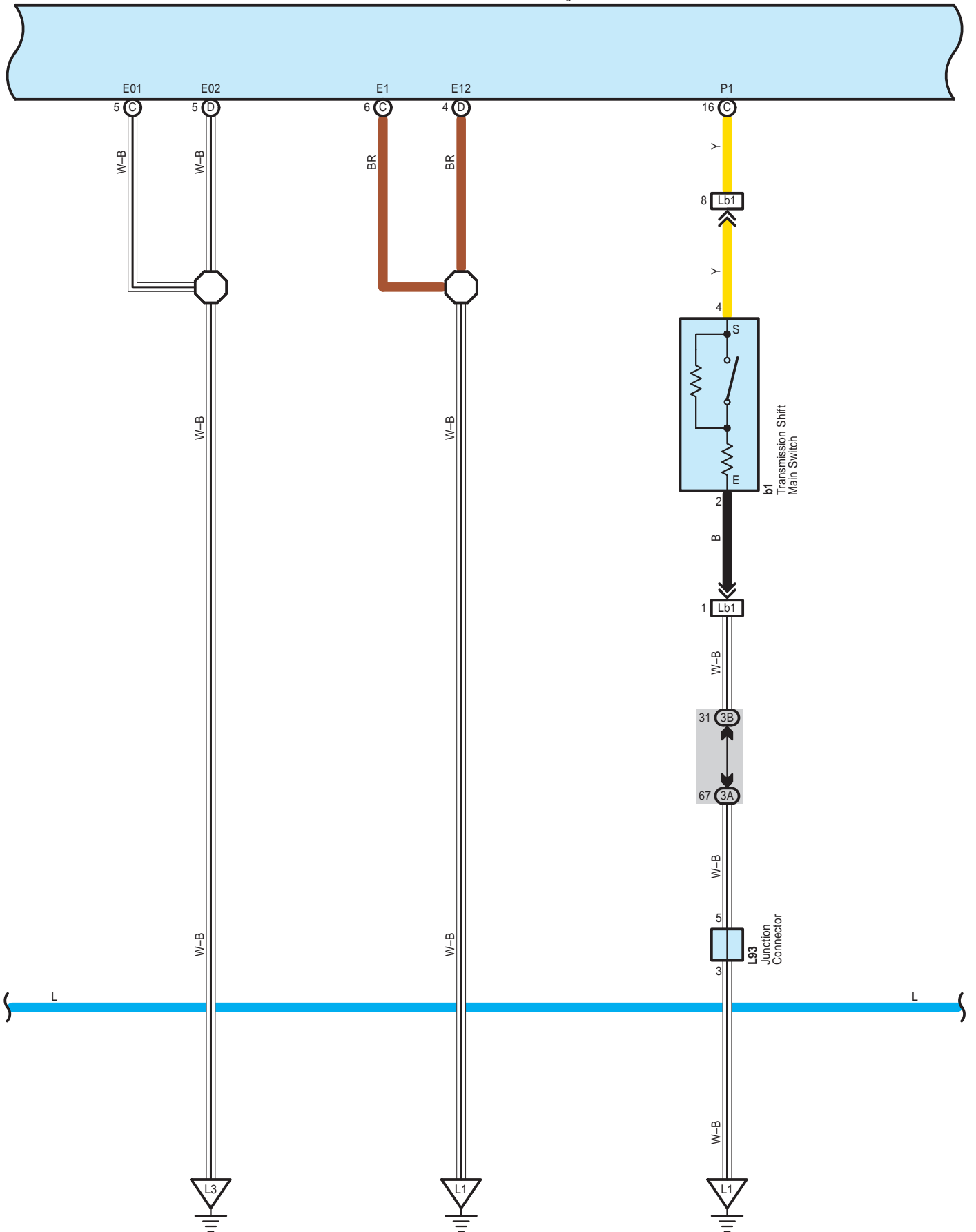

Remote Air Conditioning System

A21(A), A22(B), L5(C), L6(D)  
Power Management Control ECU

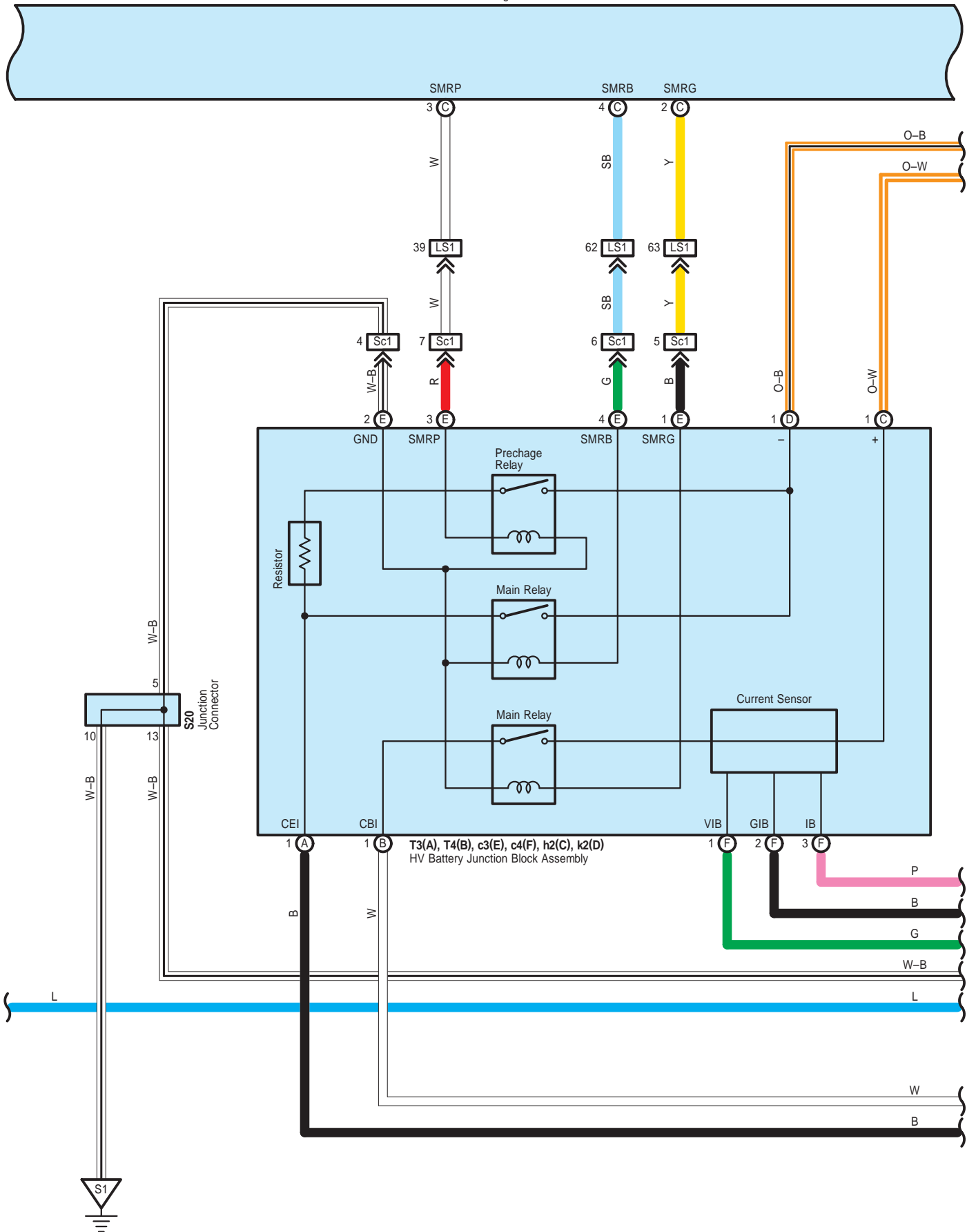

Remote Air Conditioning System

A21(A), A22(B), L5(C), L6(D)  
Power Management Control ECU

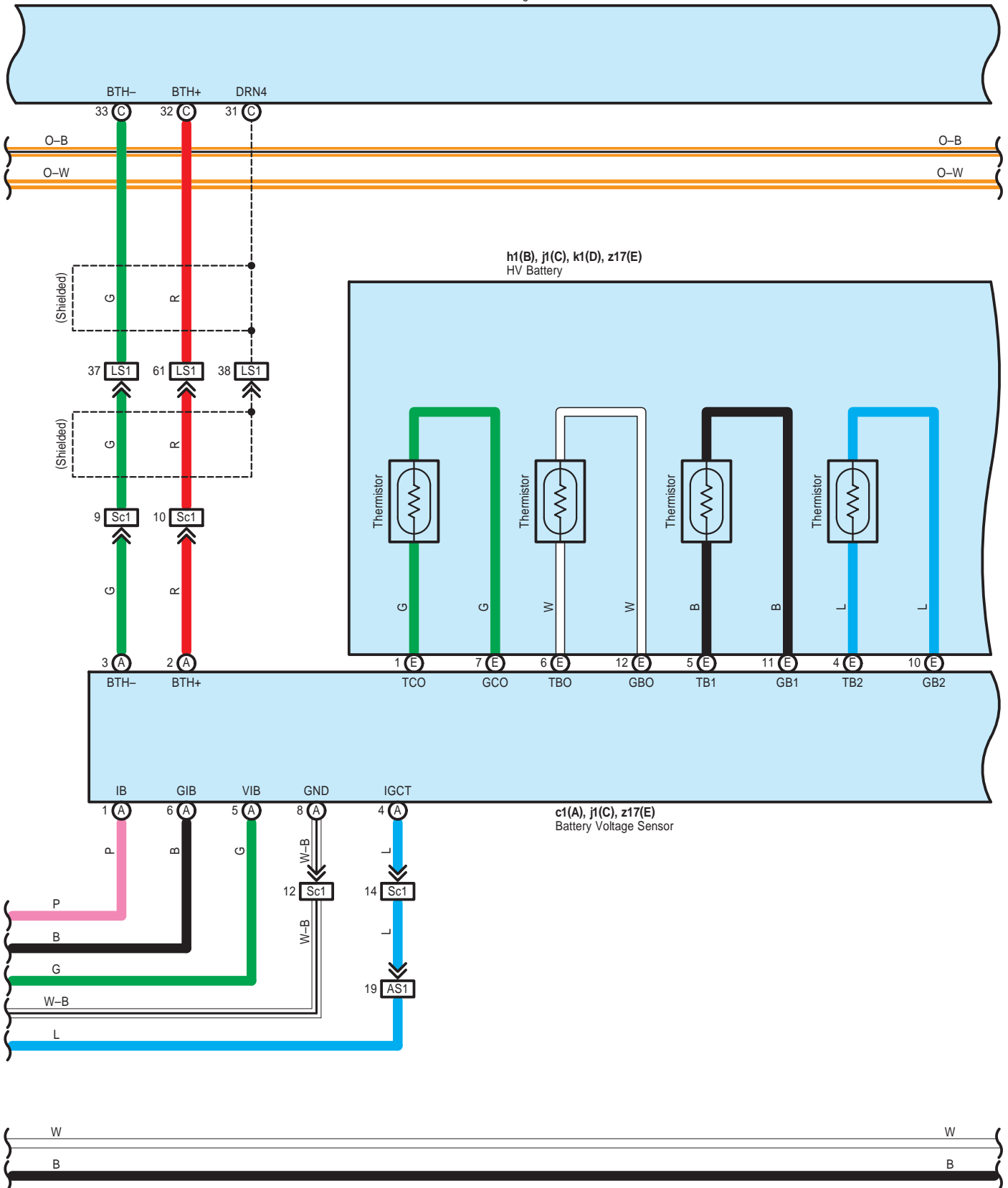



# Remote Air Conditioning System

A21(A), A22(B), L5(C), L6(D)  
Power Management Control ECU

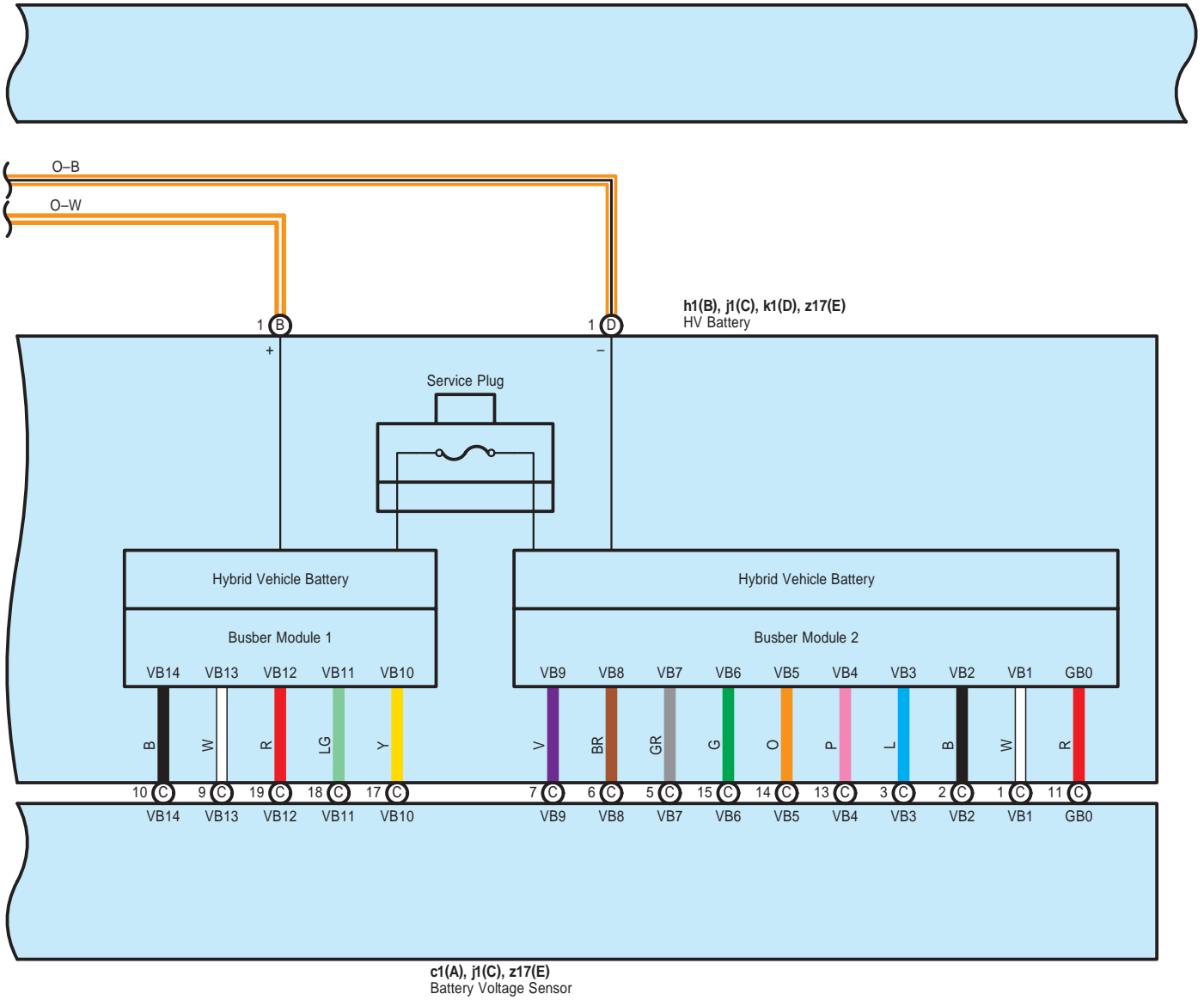

# Remote Air Conditioning System

A21(A), A22(B), L5(C), L6(D)  
Power Management Control ECU

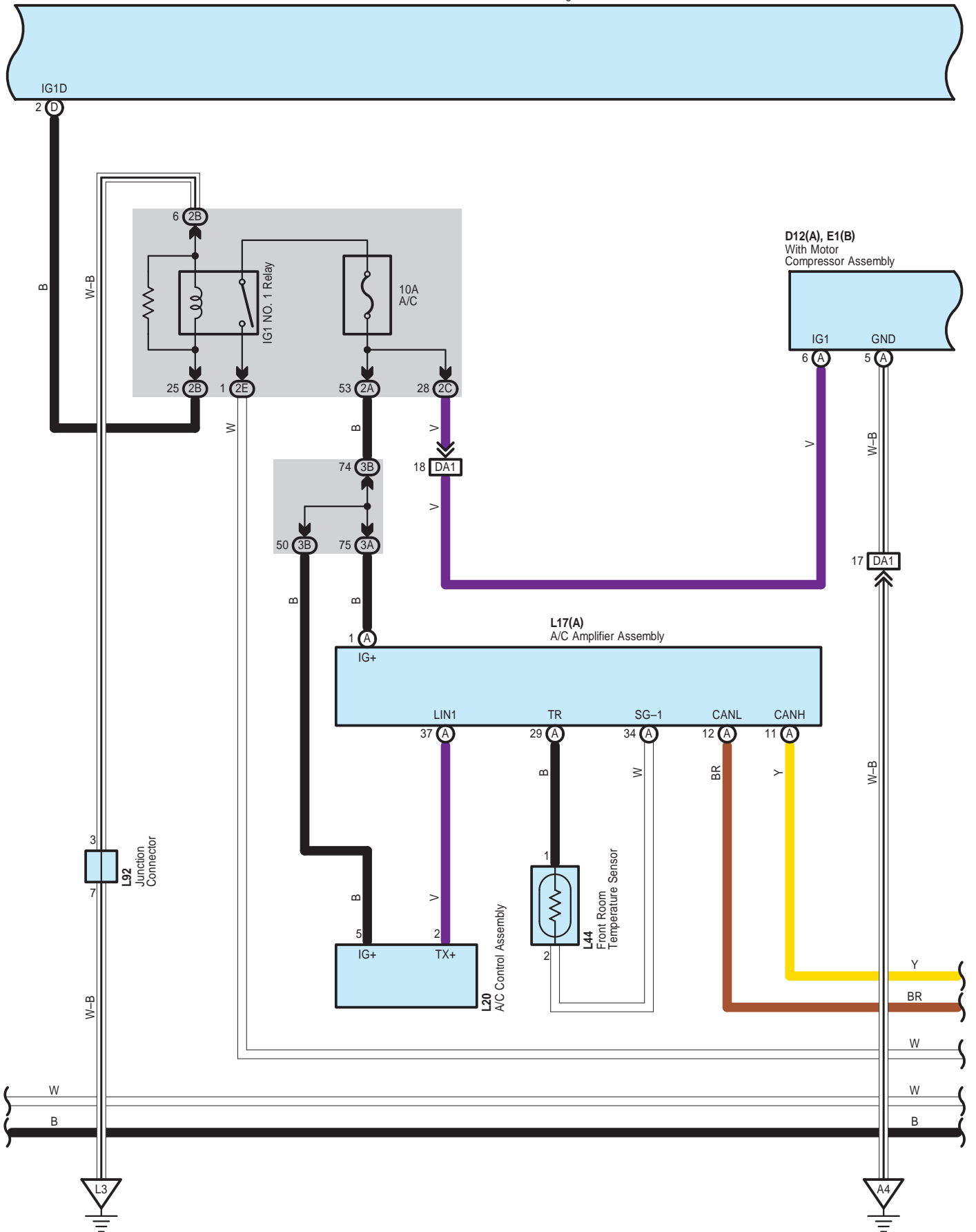

Remote Air Conditioning System

A21(A), A22(B), L5(C), L6(D)  
Power Management Control ECU

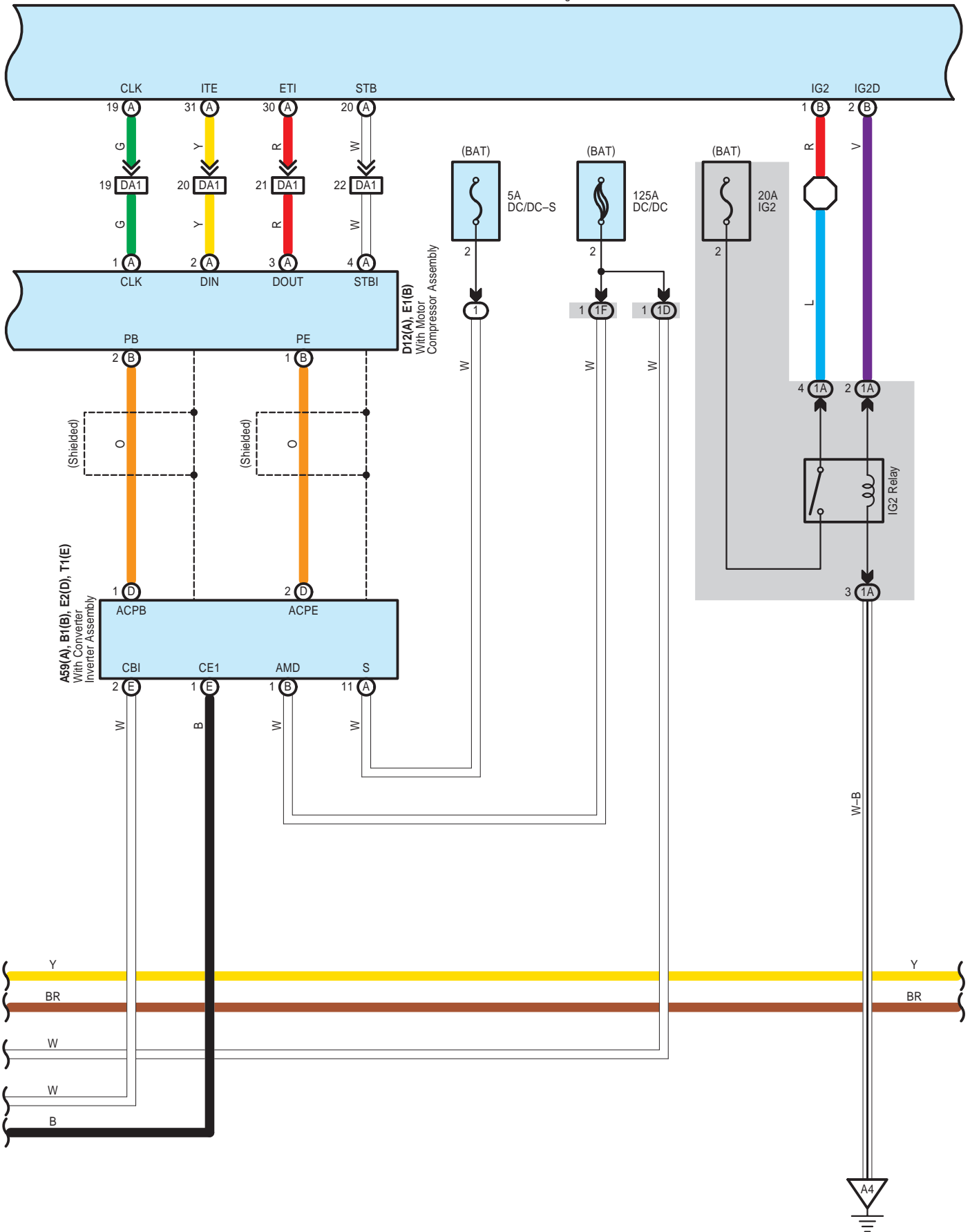

# Remote Air Conditioning System

A21(A), A22(B), L5(C), L6(D)  
Power Management Control ECU

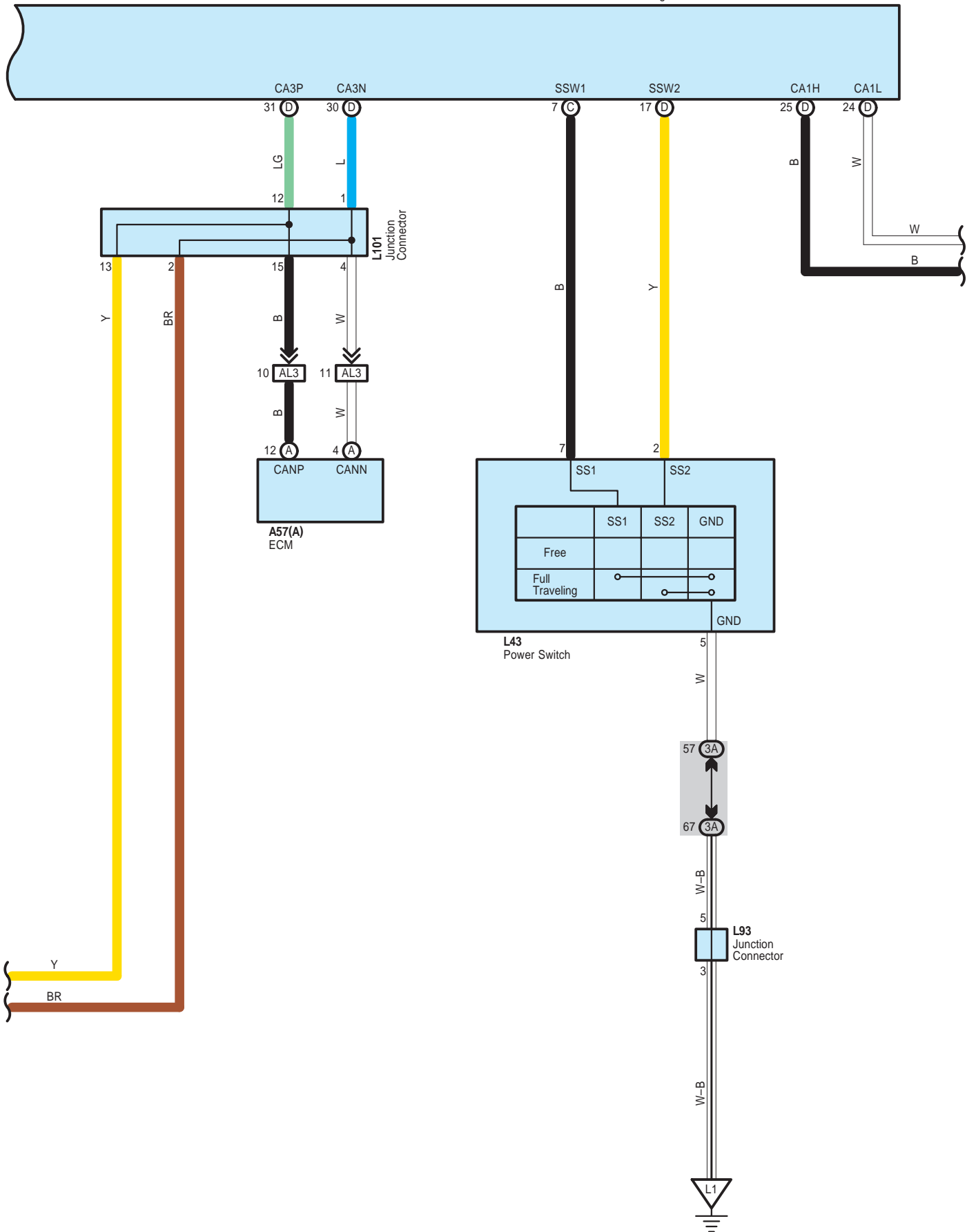

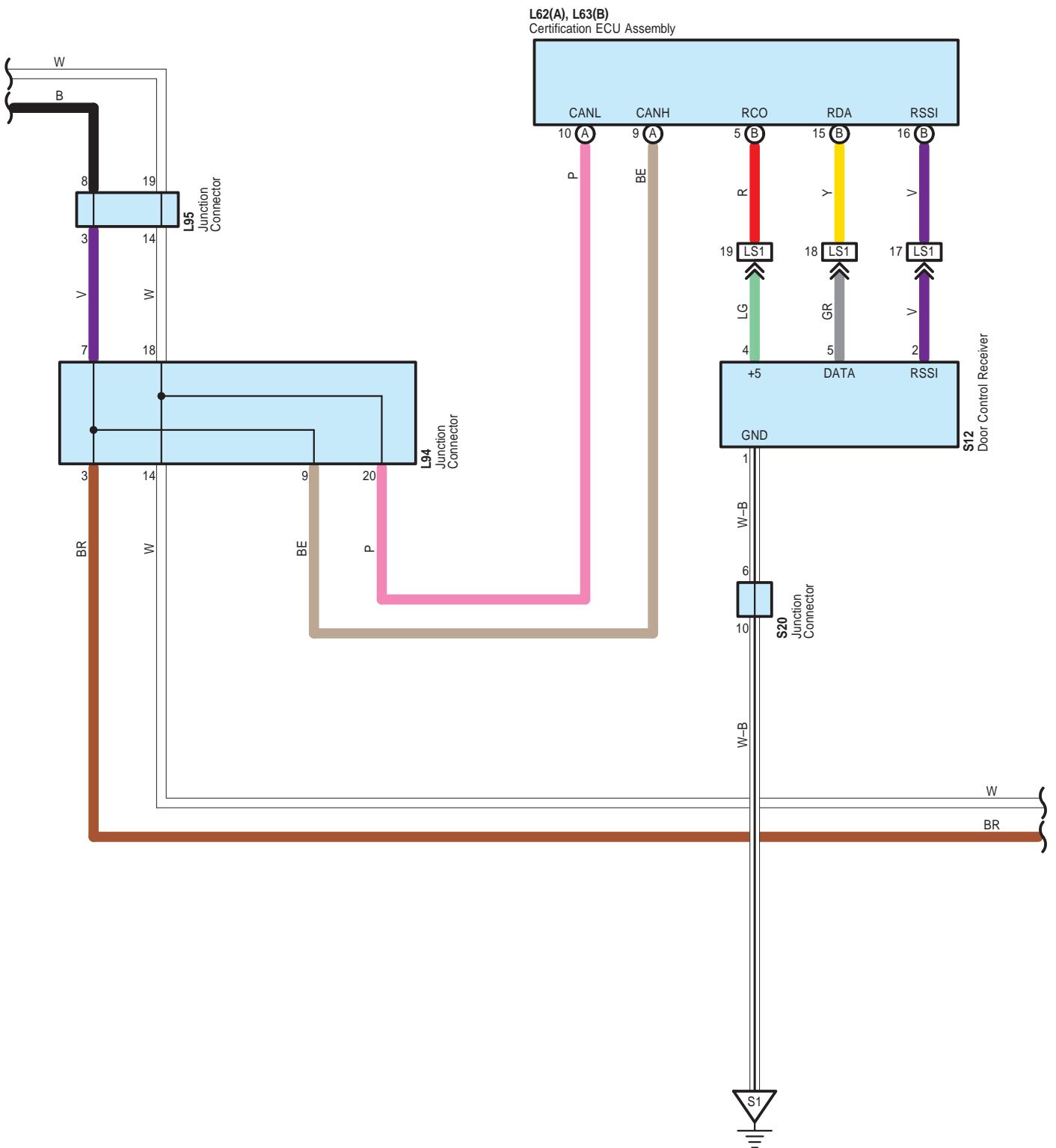

Remote Air Conditioning System

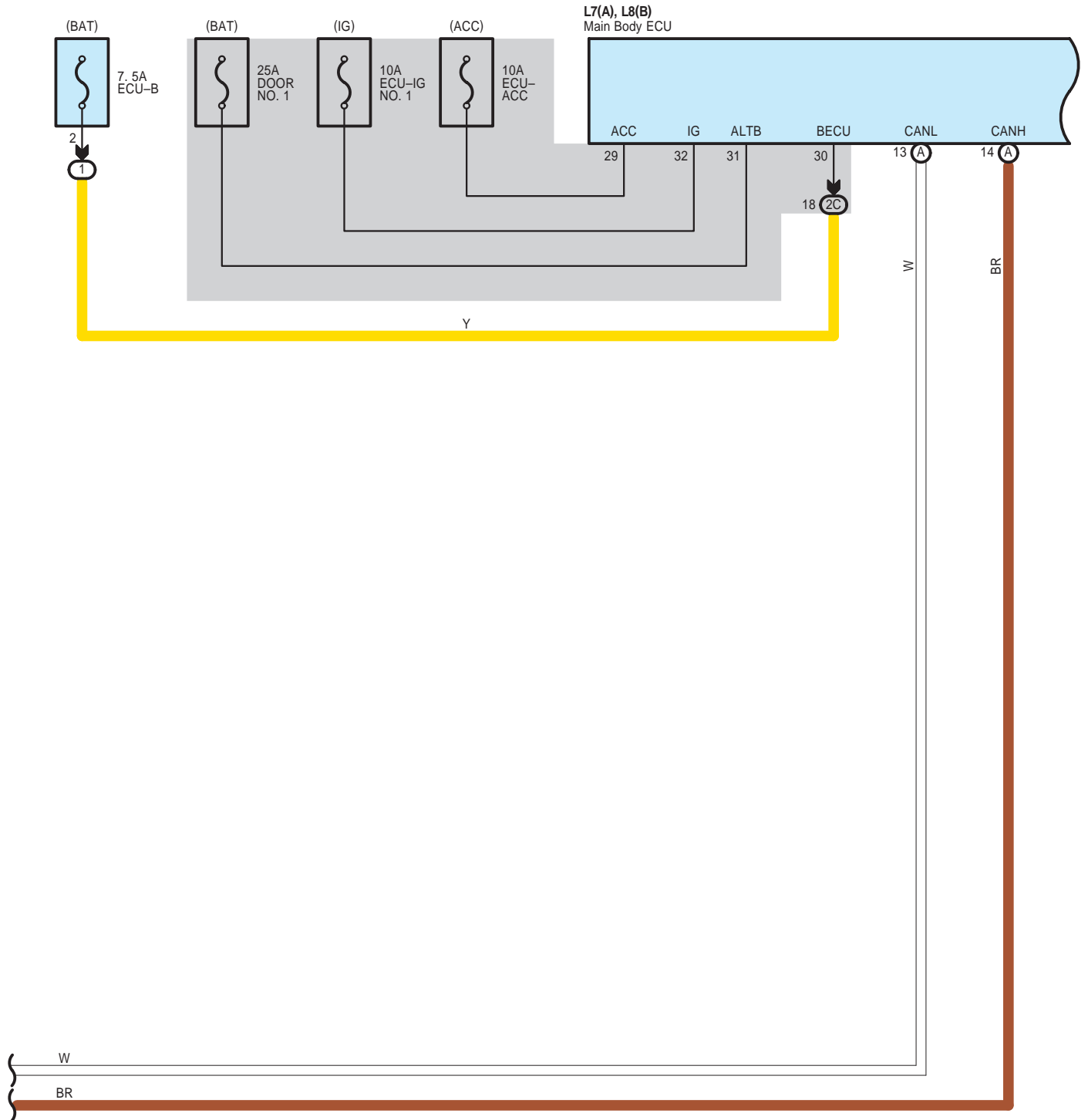

Remote Air Conditioning System

L7(A), L8(B)  
Main Body ECU

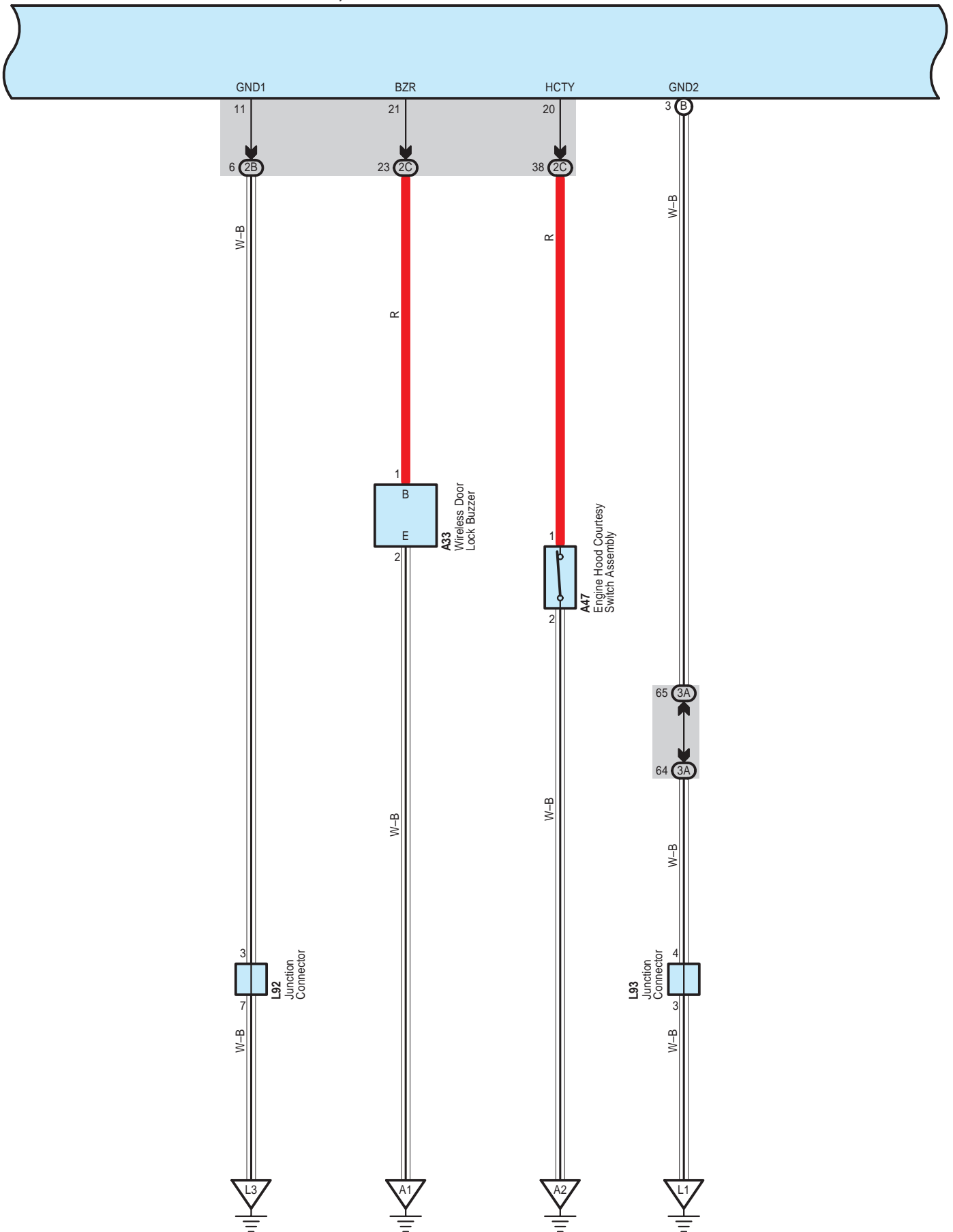

# Remote Air Conditioning System

L7(A), L8(B)  
Main Body ECU

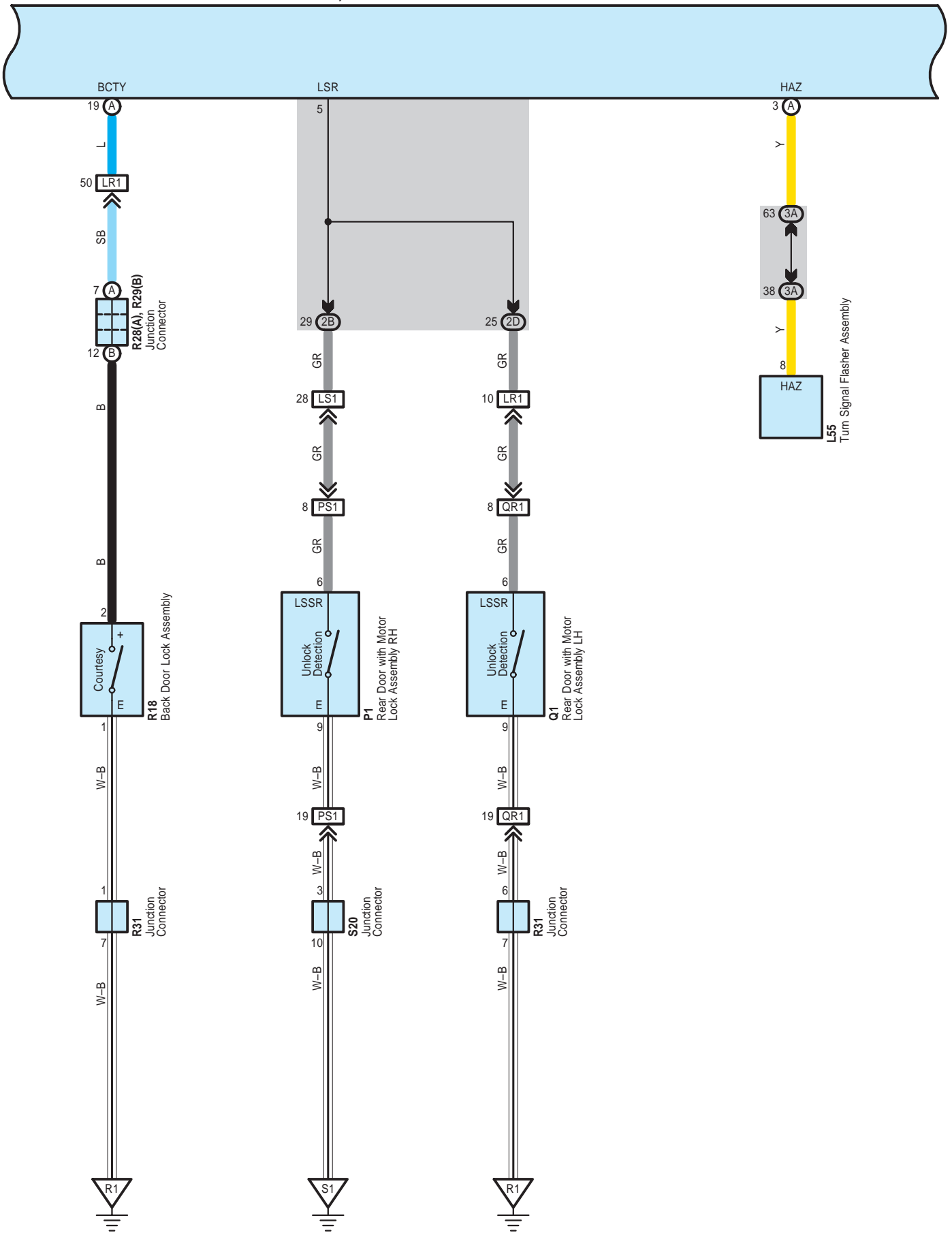



Remote Air Conditioning System

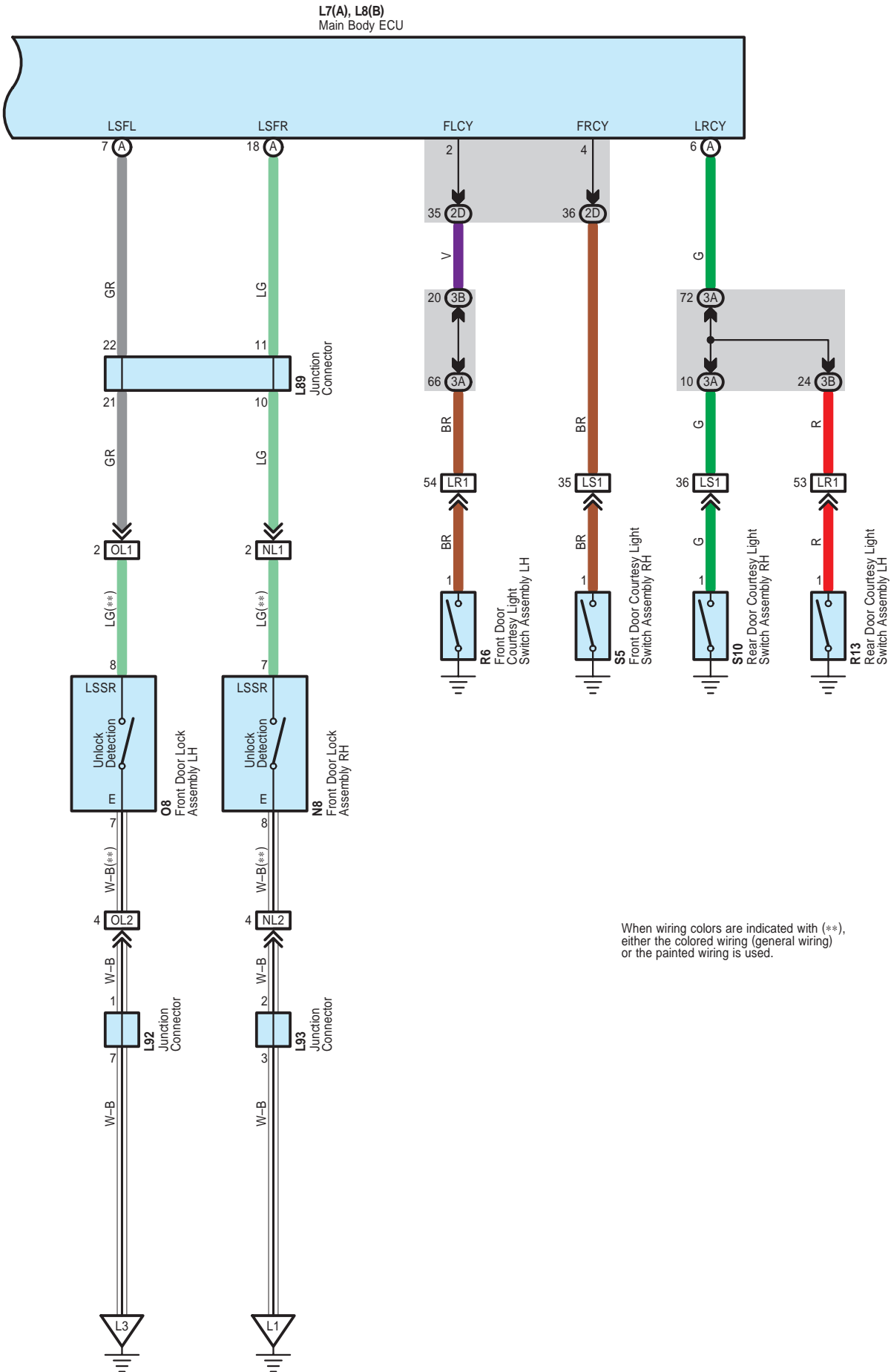

Remote Air Conditioning System

A 21  
Gray

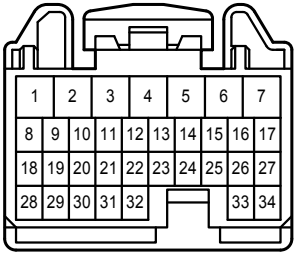

A 22  
Gray

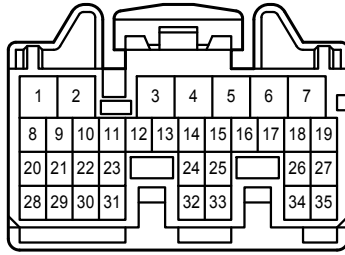

A 26  
White

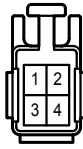

A 33  
Gray

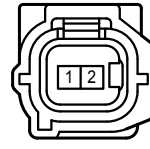

A 47  
Black

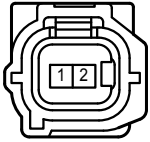

A 50  
White

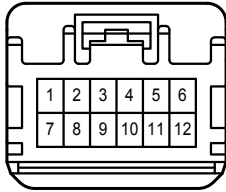

A 51  
White

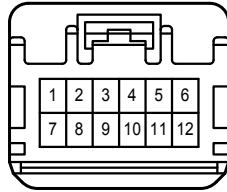

A 55  
Black

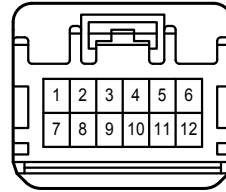

A 56  
White

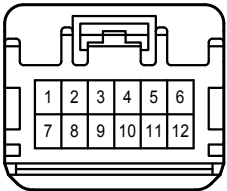

A 57  
Black

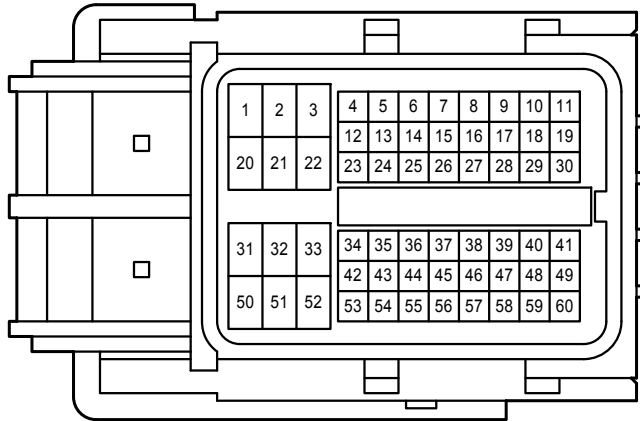

A 59  
Black

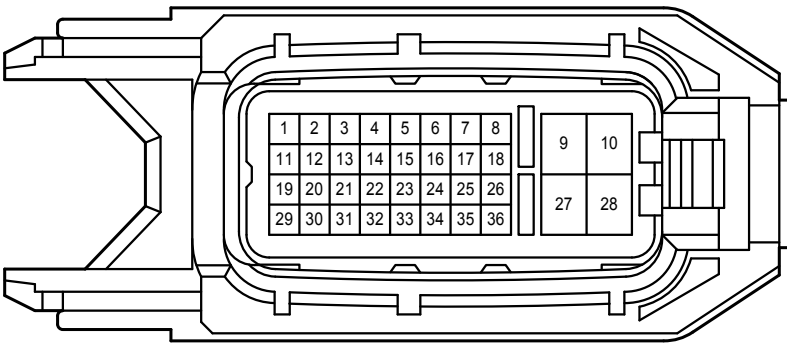

B 1

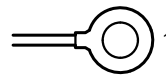

D 12  
Black

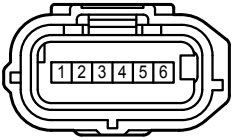

E 1  
Orange

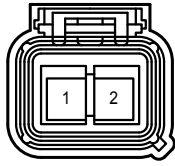

E 2  
White

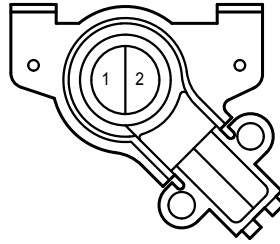

L 5  
Gray

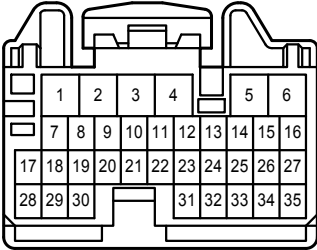

L 6  
Gray

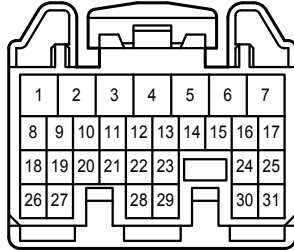

L 7  
White

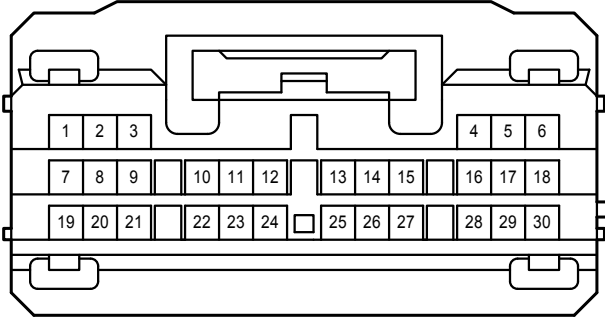

L 8  
White

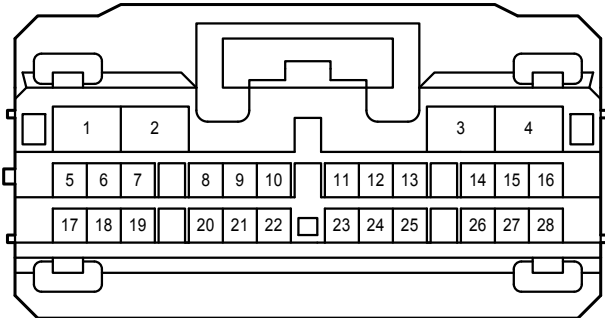

L 17  
White

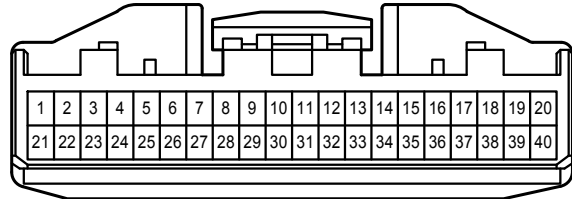

L 20  
Black

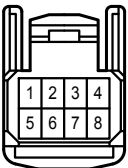

L 43  
Black

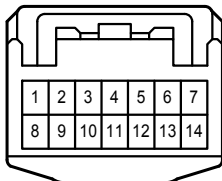

L 44  
Black



L 55  
Blue



Remote Air Conditioning System

L 62  
White

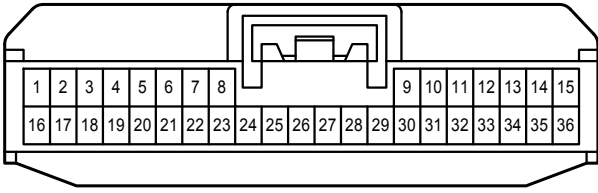

L 63  
White

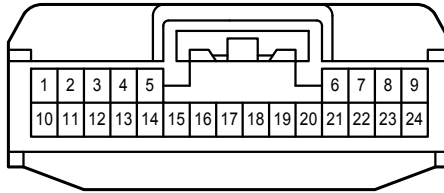

L 89  
Black

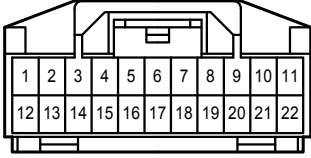

L 92  
White

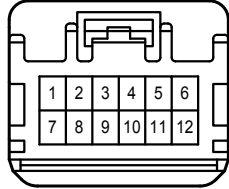

L 93  
White

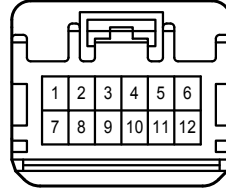

L 94  
White

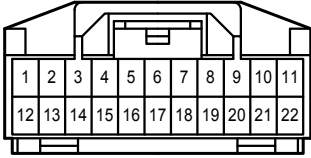

L 95  
White

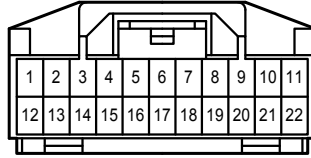

L101  
Black

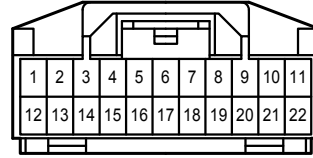

N 8  
White

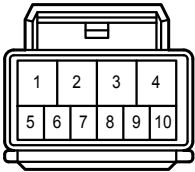

O 8  
White

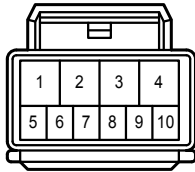

P 1  
White

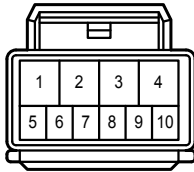

Q 1  
White

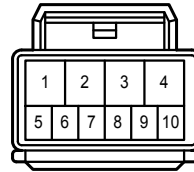

R 6  
Black



R 13  
Black



R 18  
White

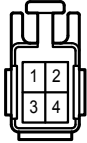

R 28  
White

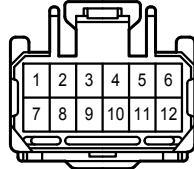

R 29  
White

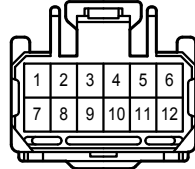

R 31  
White

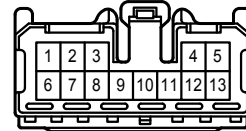

S 5  
Black



S 10  
Black



S 12  
Blue

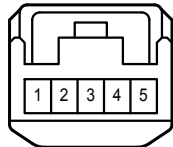

S 20  
White

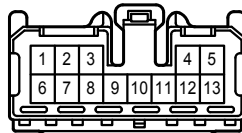

T 1  
White

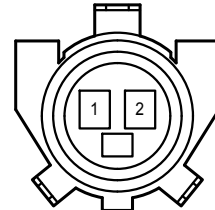

Remote Air Conditioning System

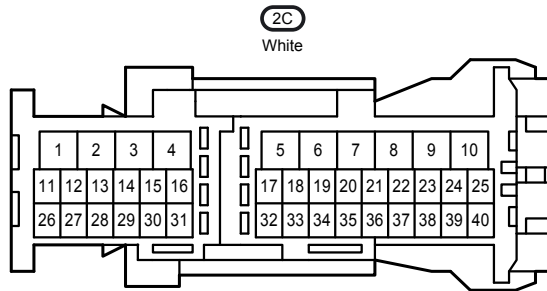
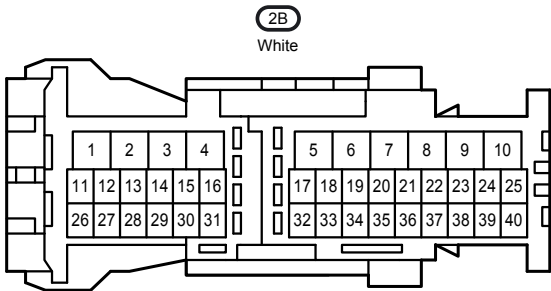
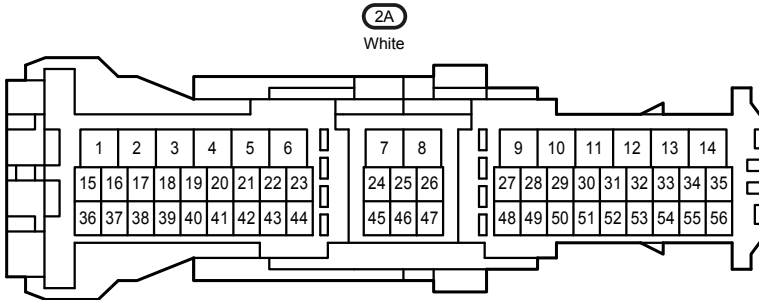
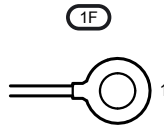
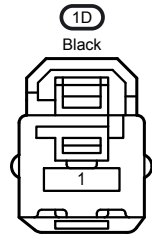
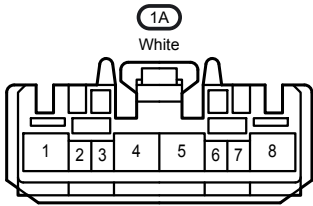
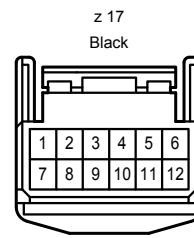
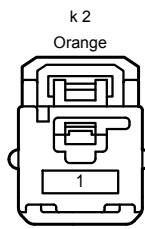
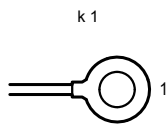
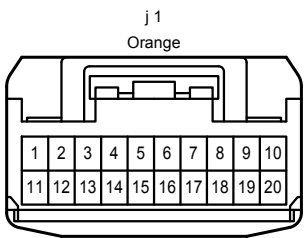
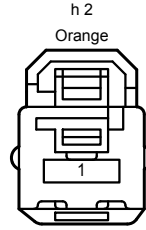
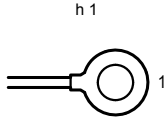
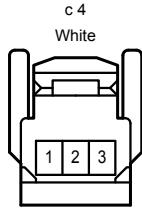
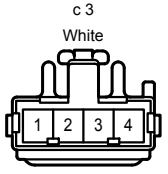
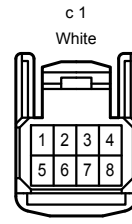
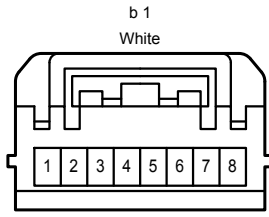
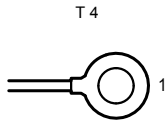
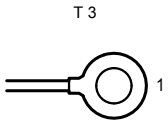

Remote Air Conditioning System

2D  
White

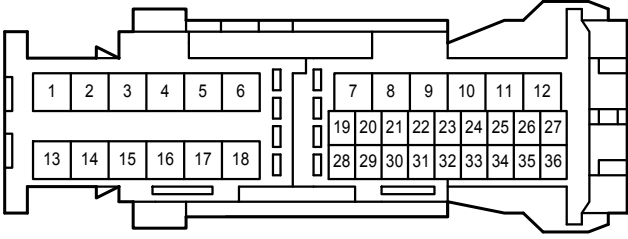

2E  
White

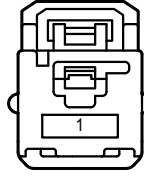

3A  
White

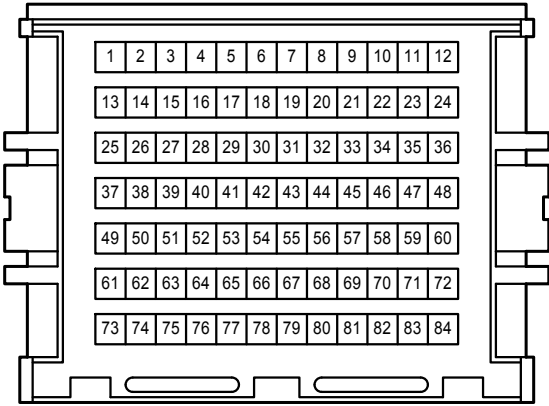

3B  
White

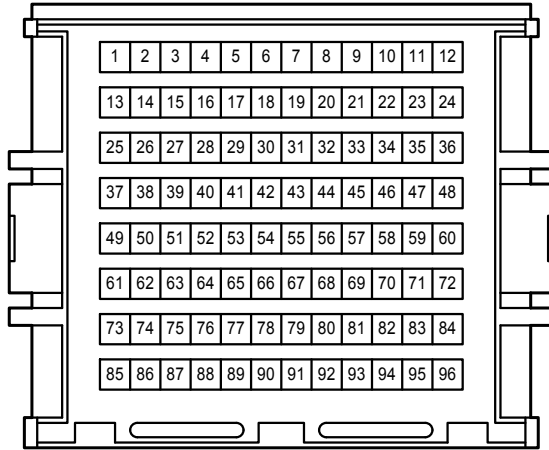

AL2  
Gray

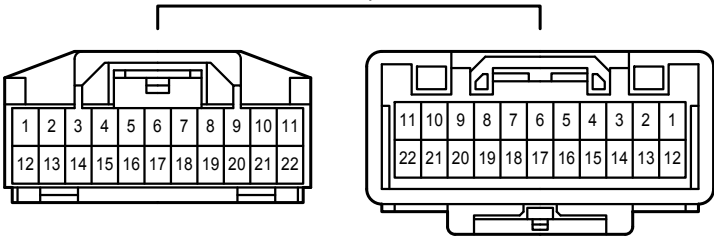

AL3  
White

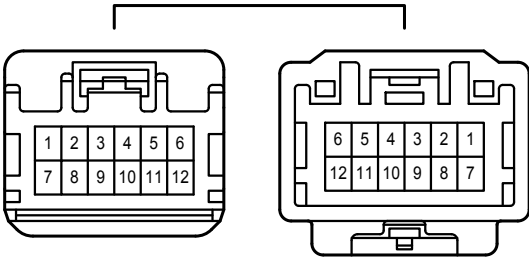

AS1  
White

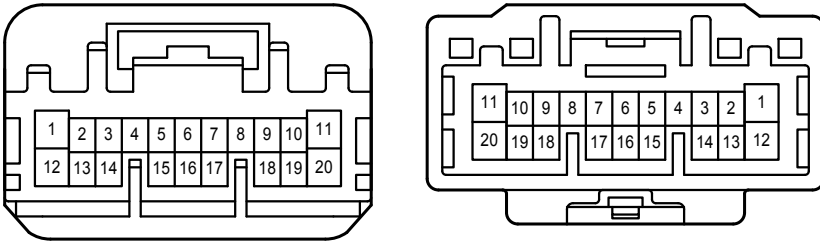

DA1  
White

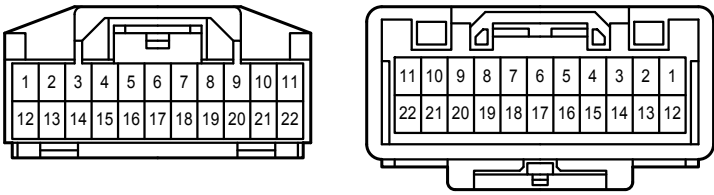

LR1  
White

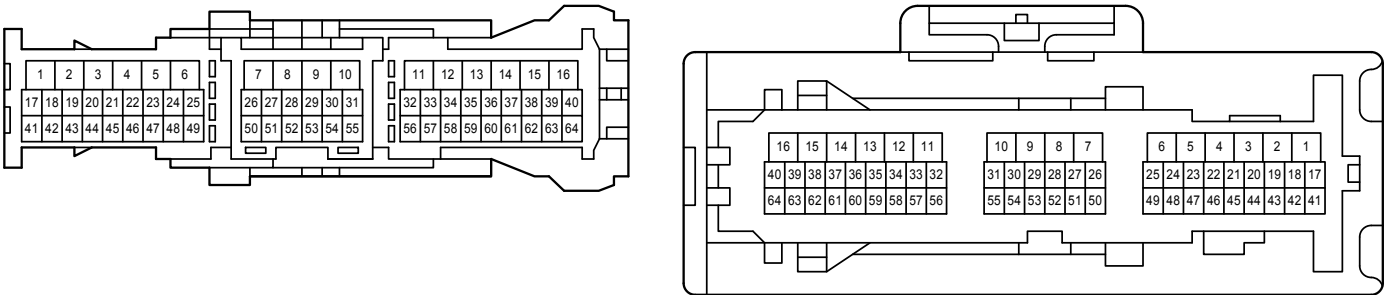

LS1  
White

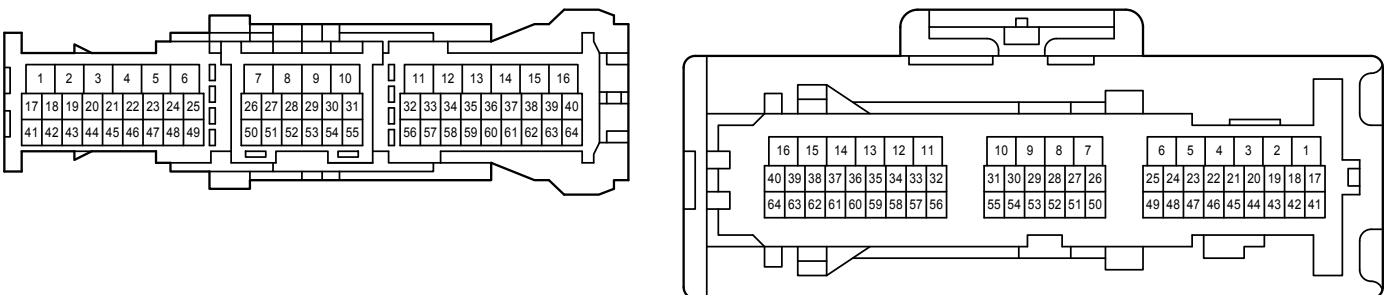

Lb1  
White

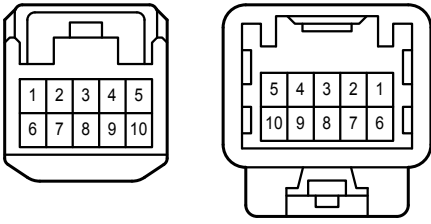

NL1  
White

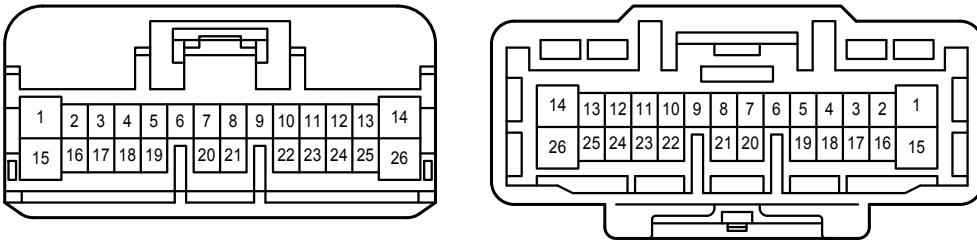

NL2  
White

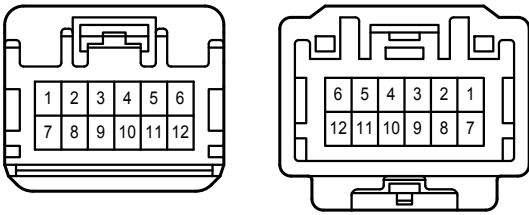

OL1  
White

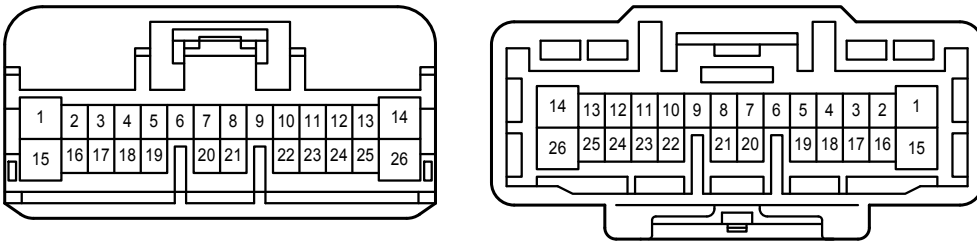

OL2  
White

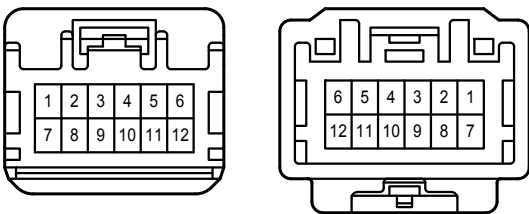



Remote Air Conditioning System

PS1  
White

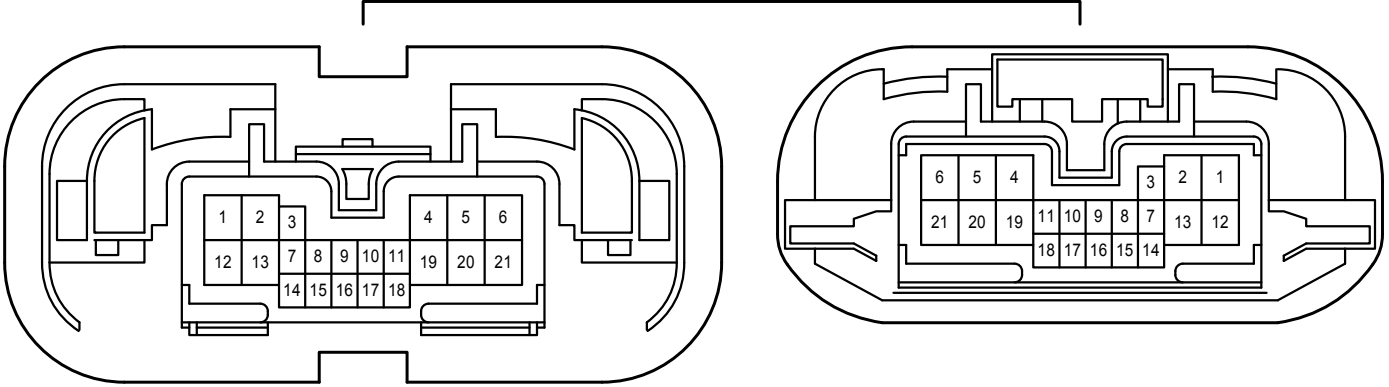

QR1  
White

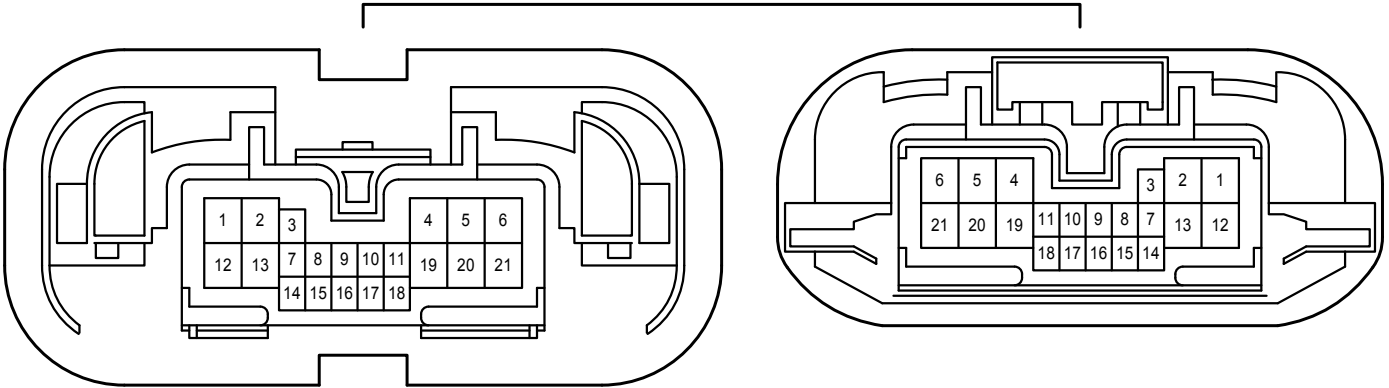

Sc1  
White

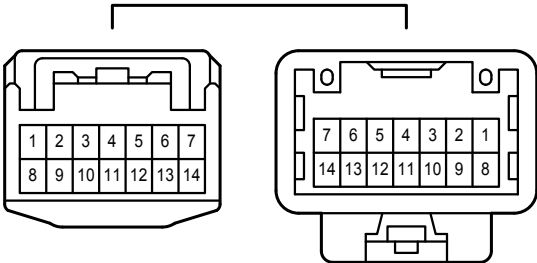

# Remote Control Mirror

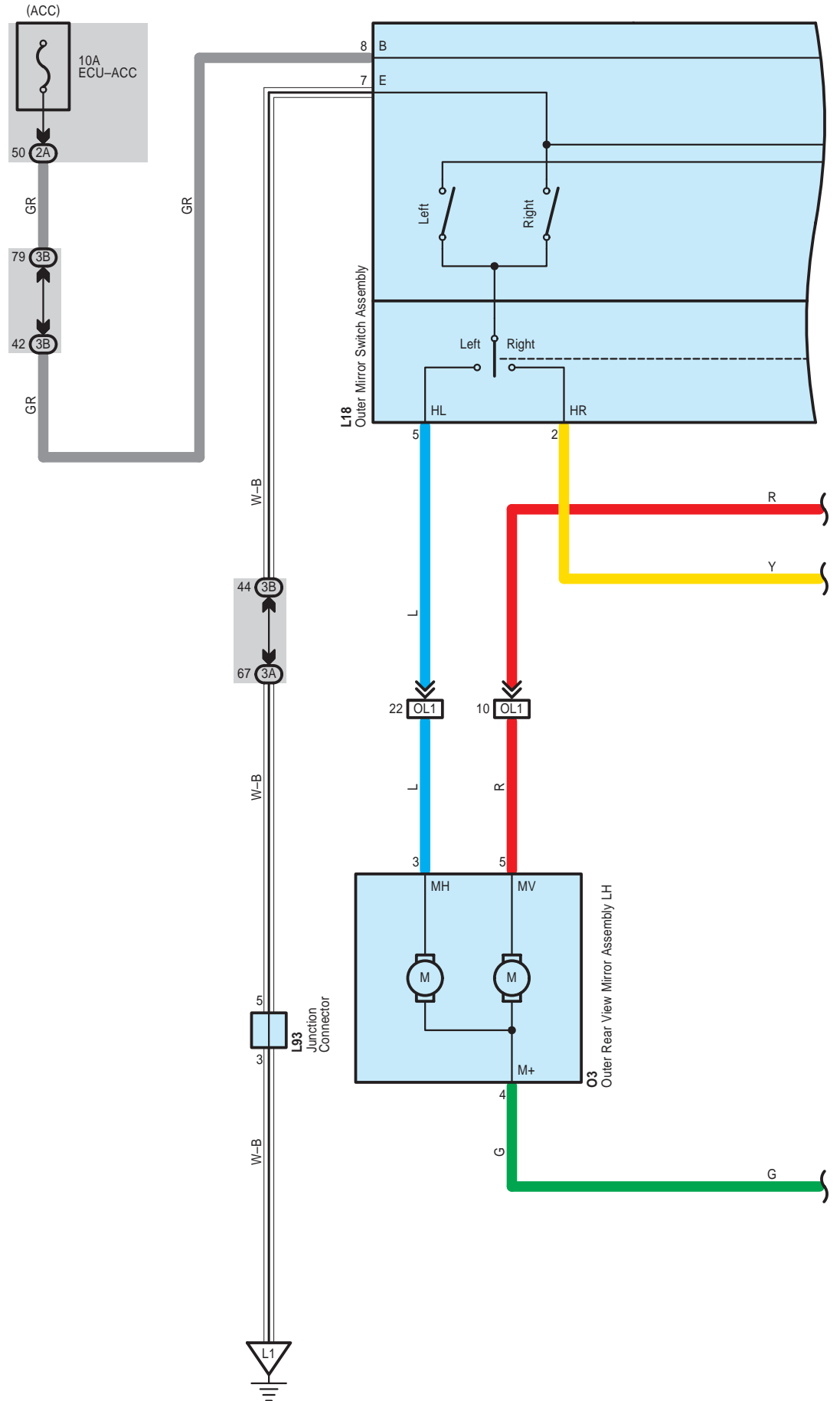

Remote Control Mirror

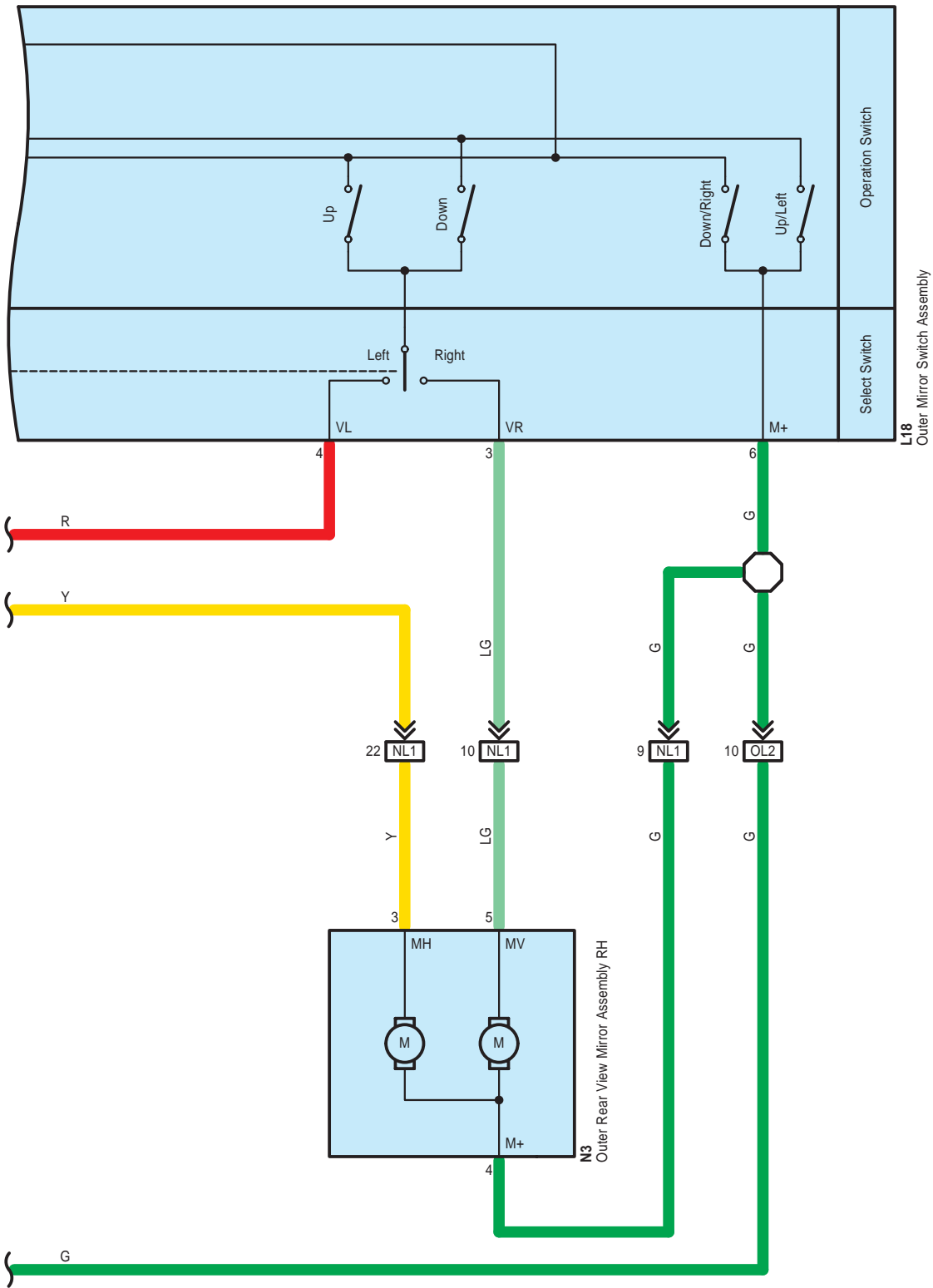

Remote Control Mirror

L 18

White

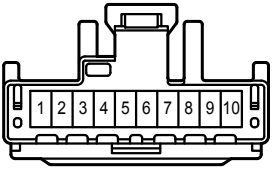

L 93

White

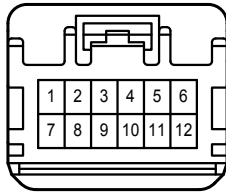

N 3

White

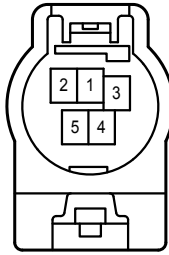

O 3

White

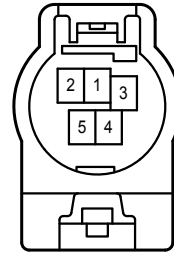

2A

White

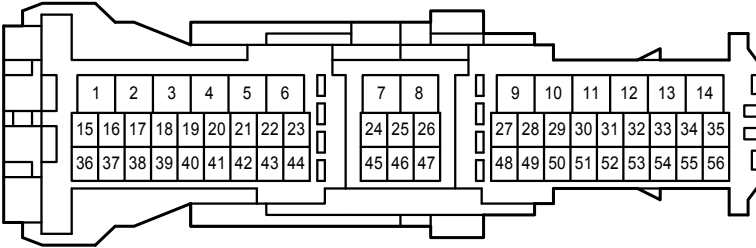

3A

White

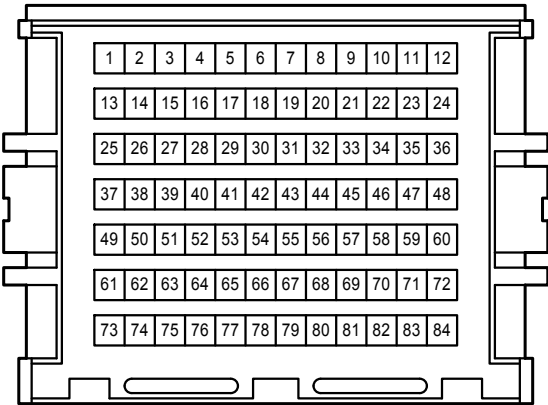

3B

White

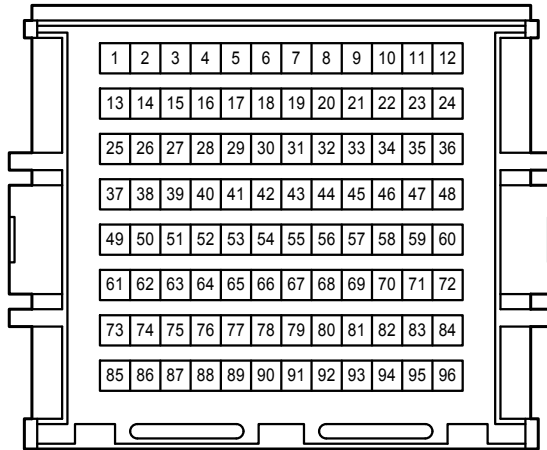

NL1

White

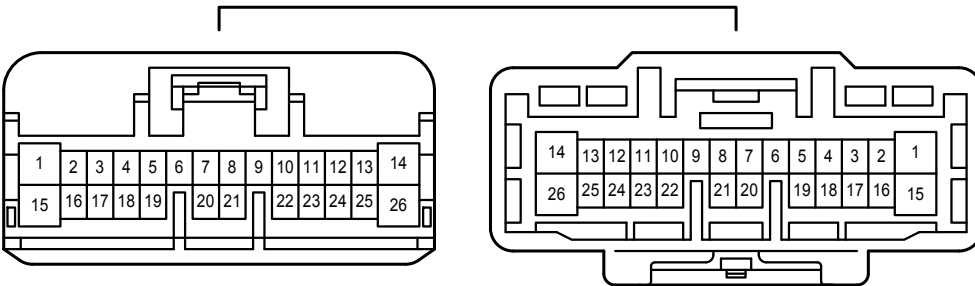

Remote Control Mirror

OL1  
White

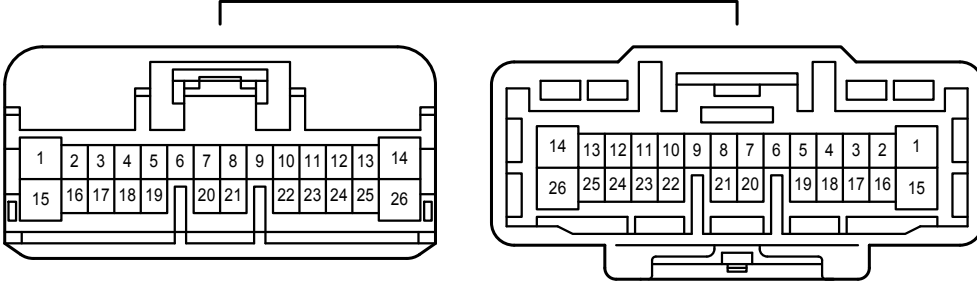

OL2  
White

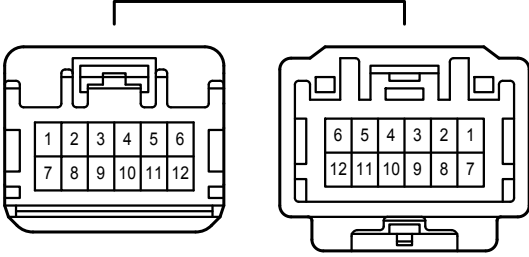

\* 1 : w/ Sliding Roof  
 \* 2 : w/o Sliding Roof

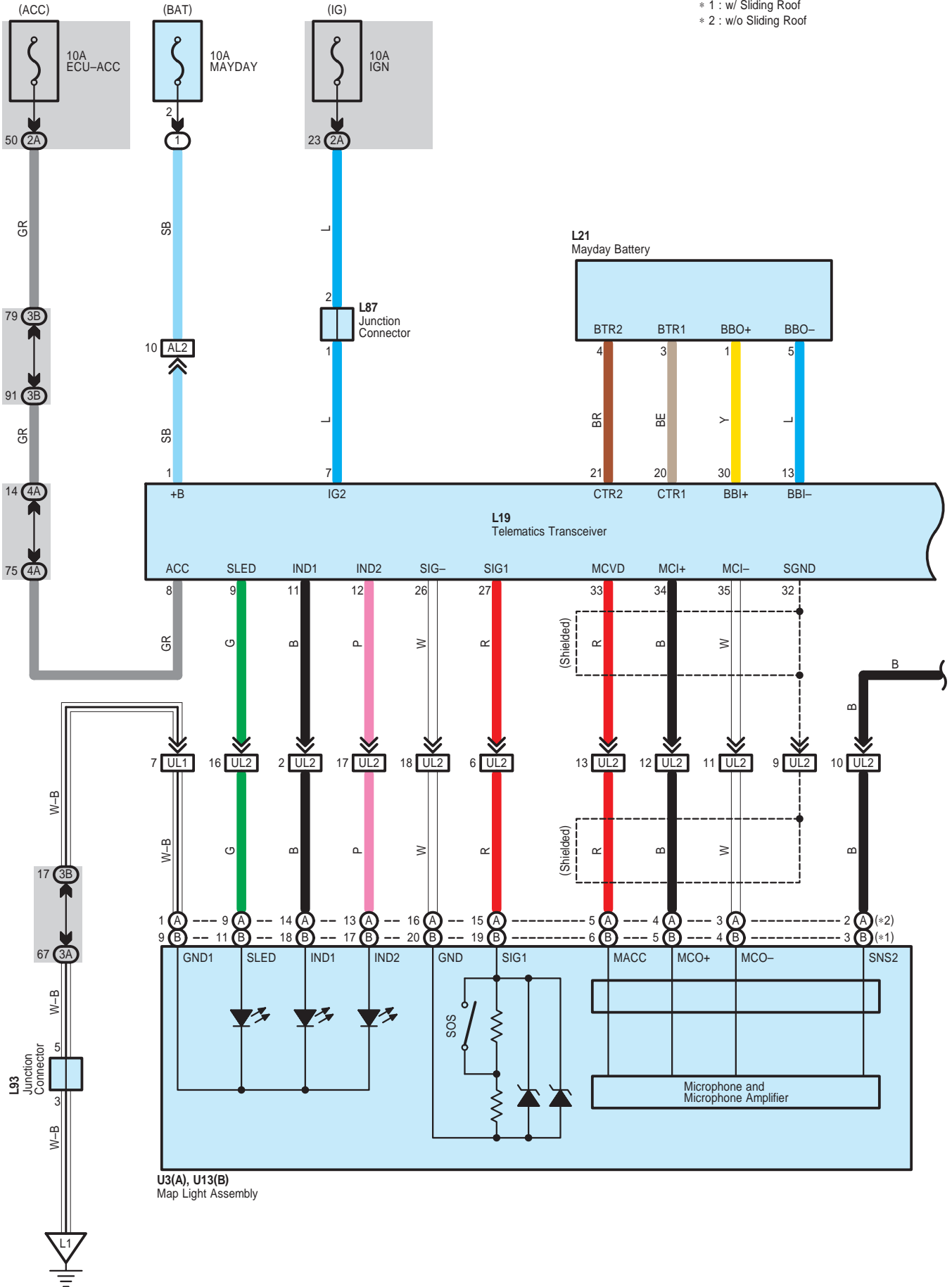

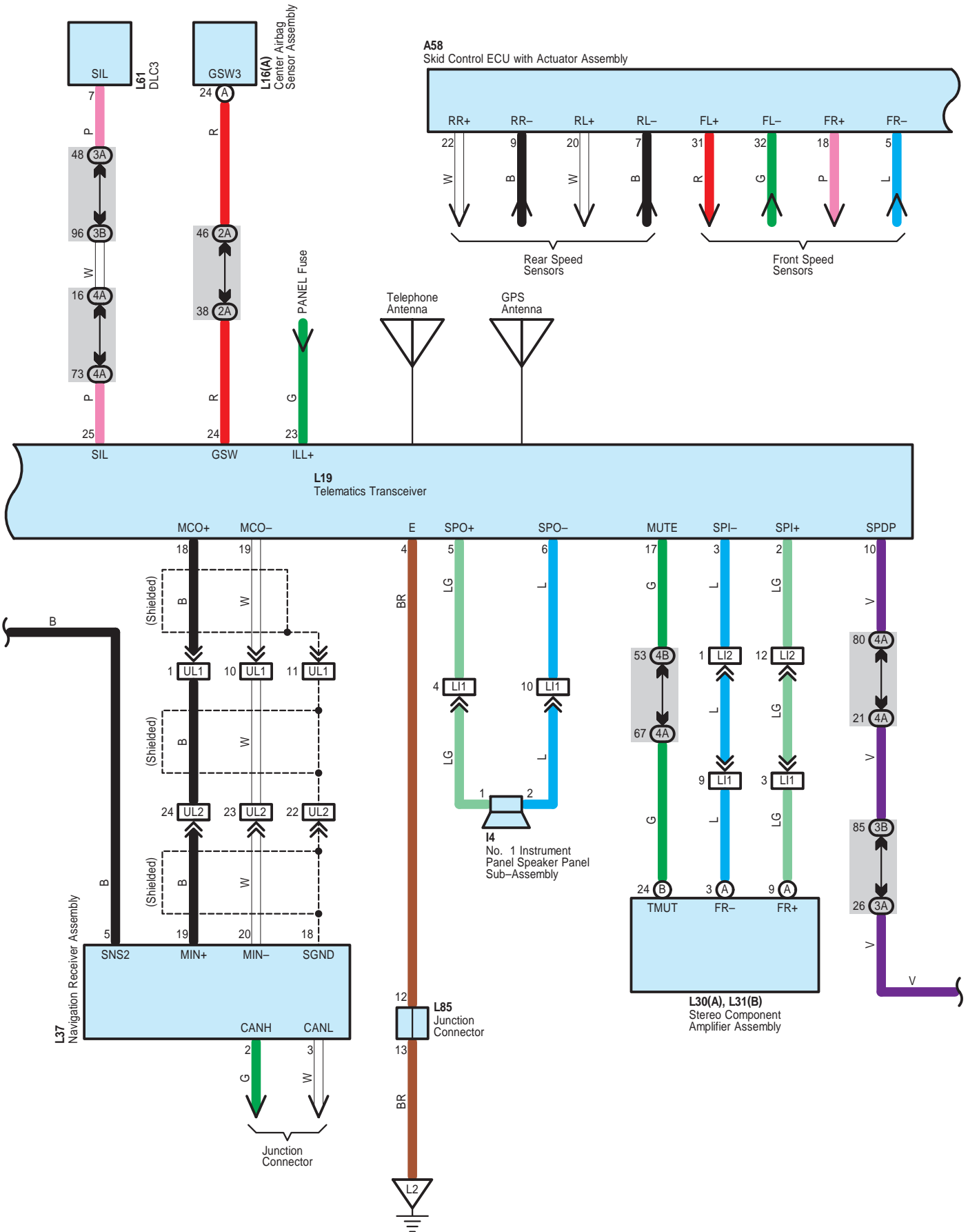





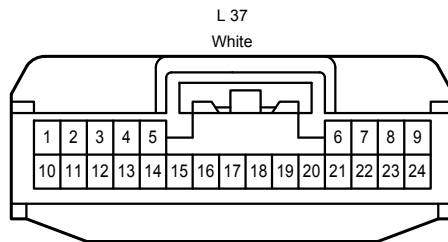
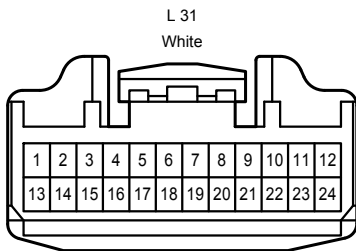
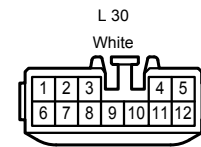
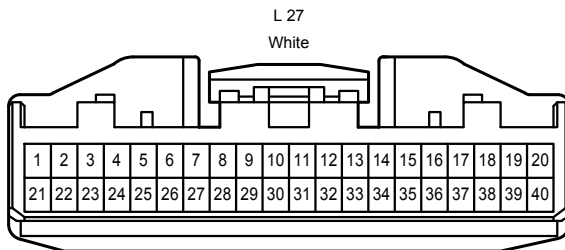
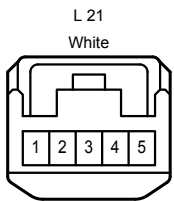
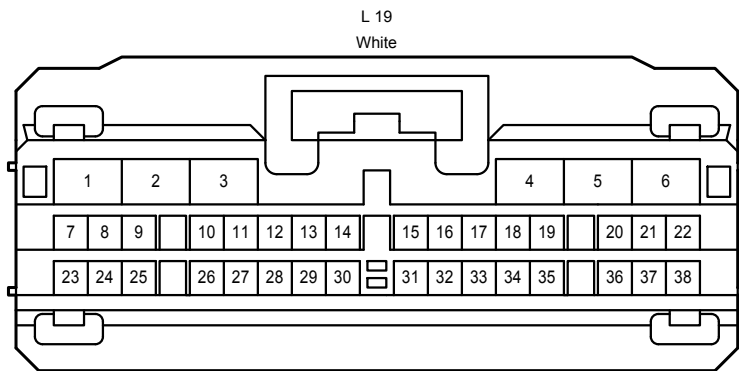
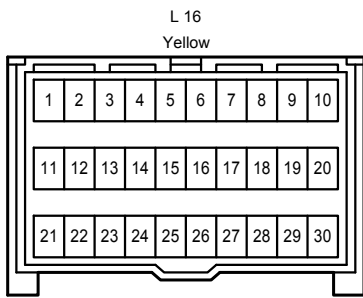
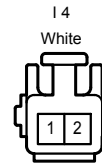
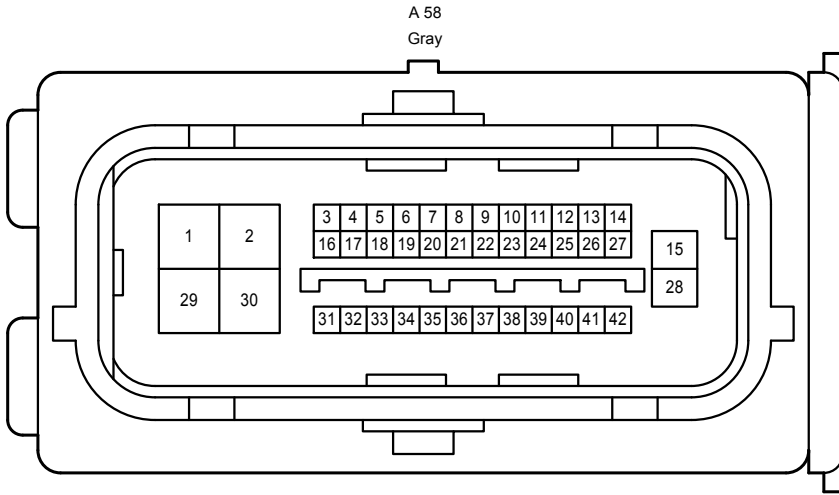

Safety Connect

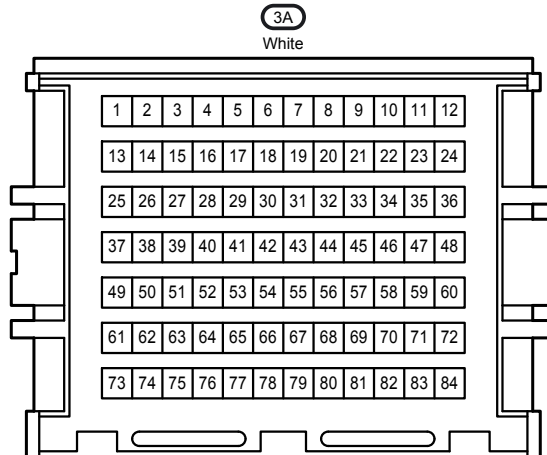
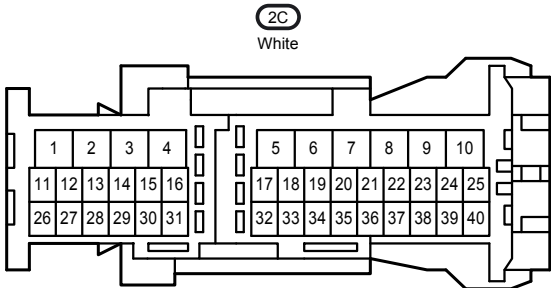
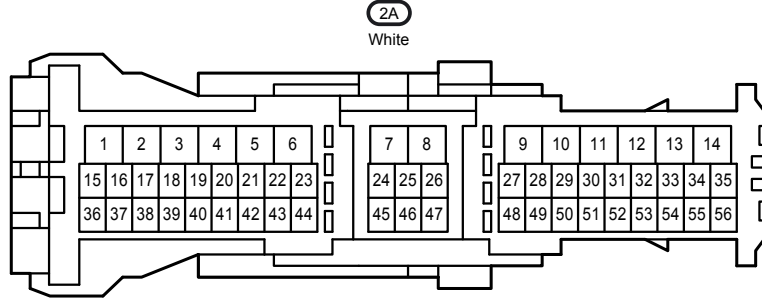
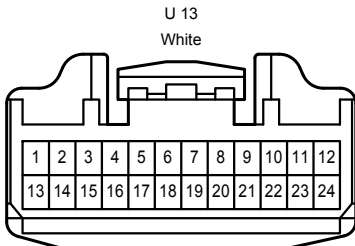
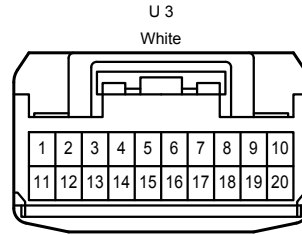
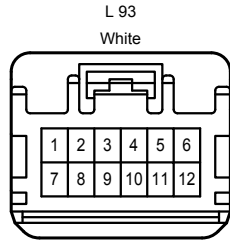
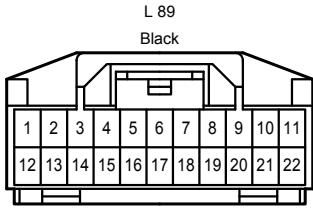
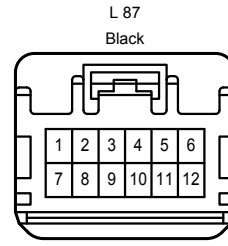
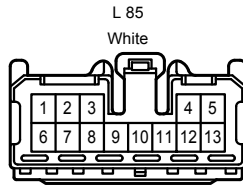
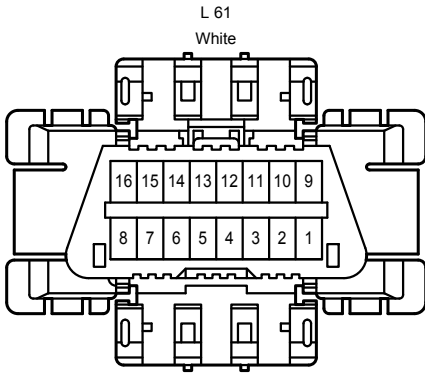

3B  
White

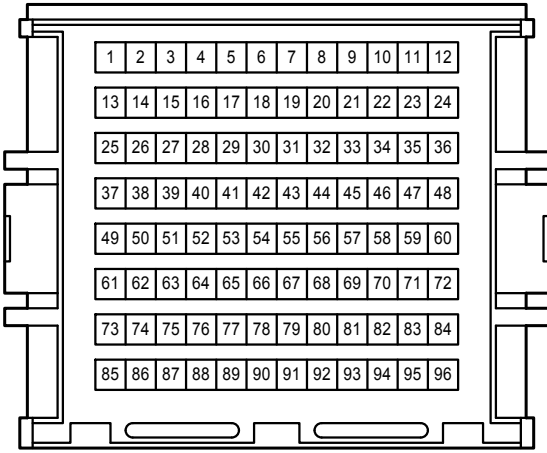

4A  
White

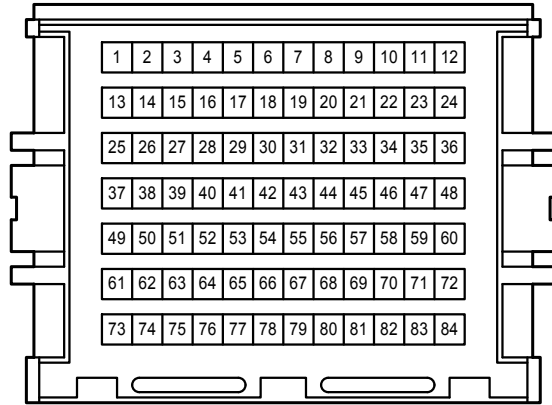

4B  
White

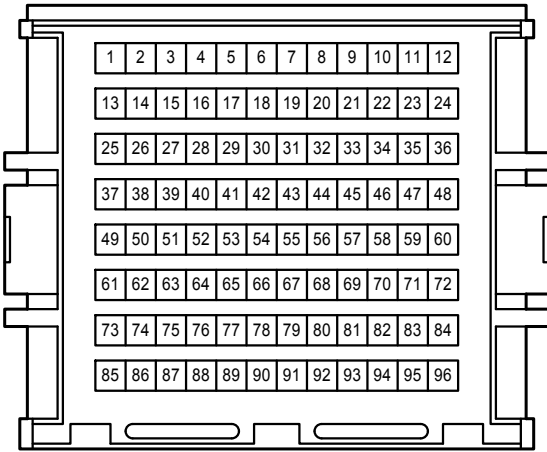

AL2  
Gray

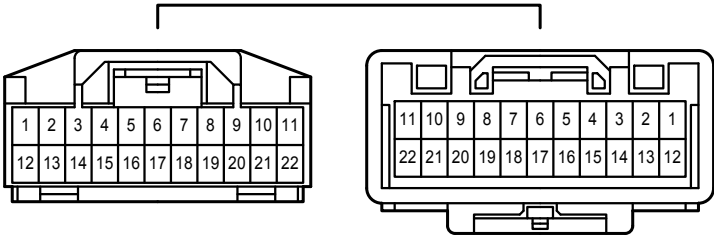

L11  
Black

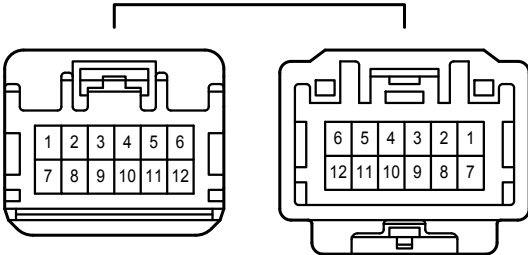

LI2  
White

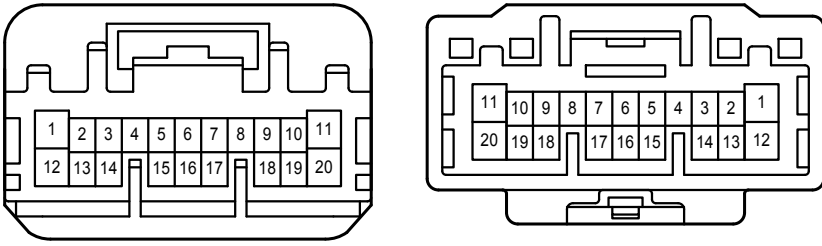

UL1  
Gray

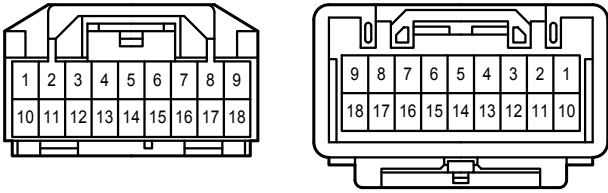

UL2  
White

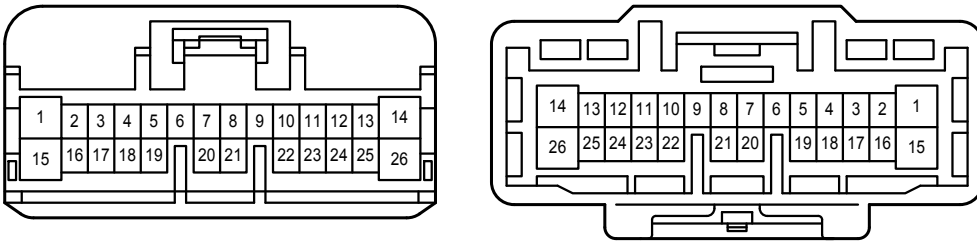

# Seat Belt Warning

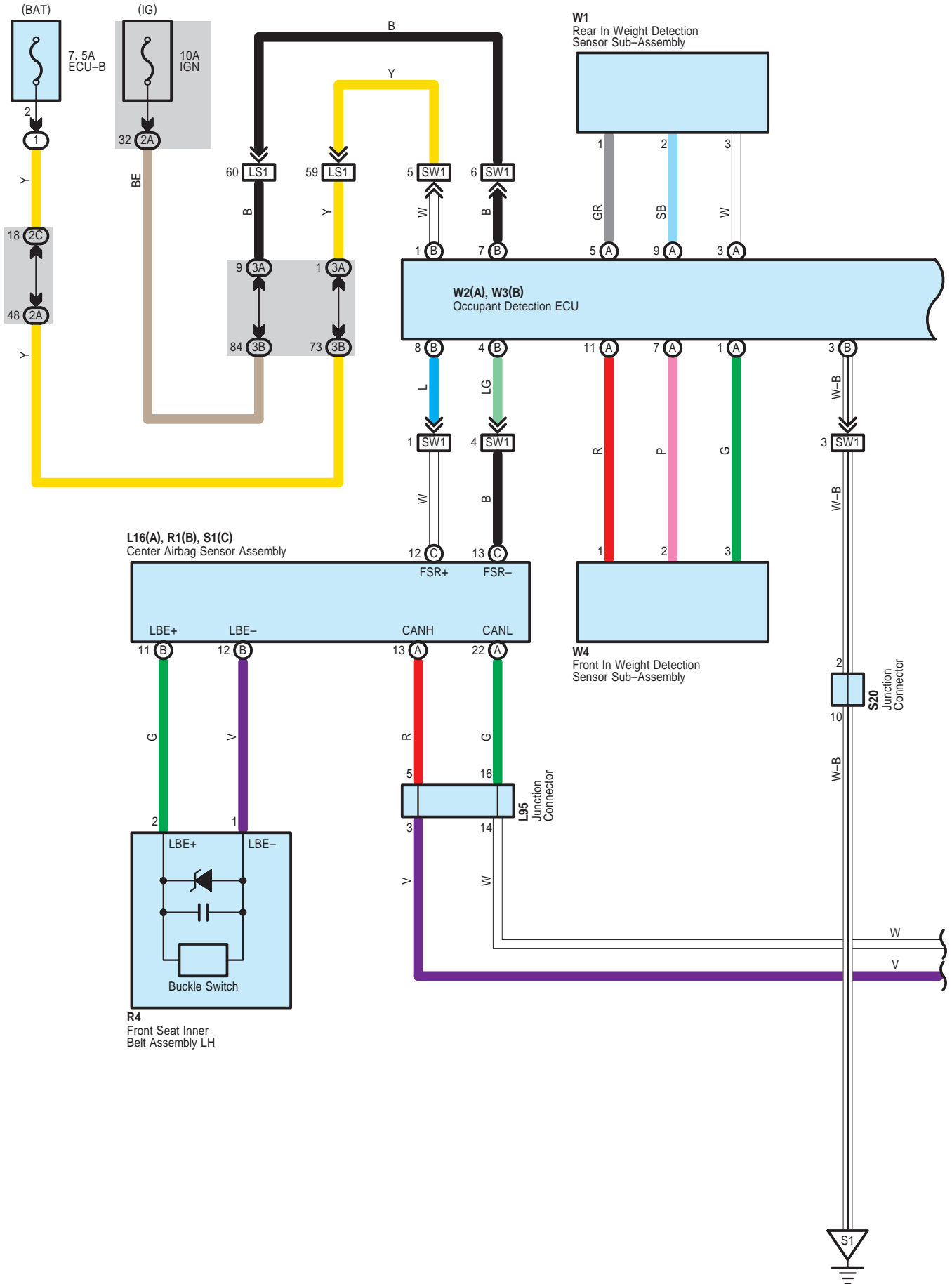

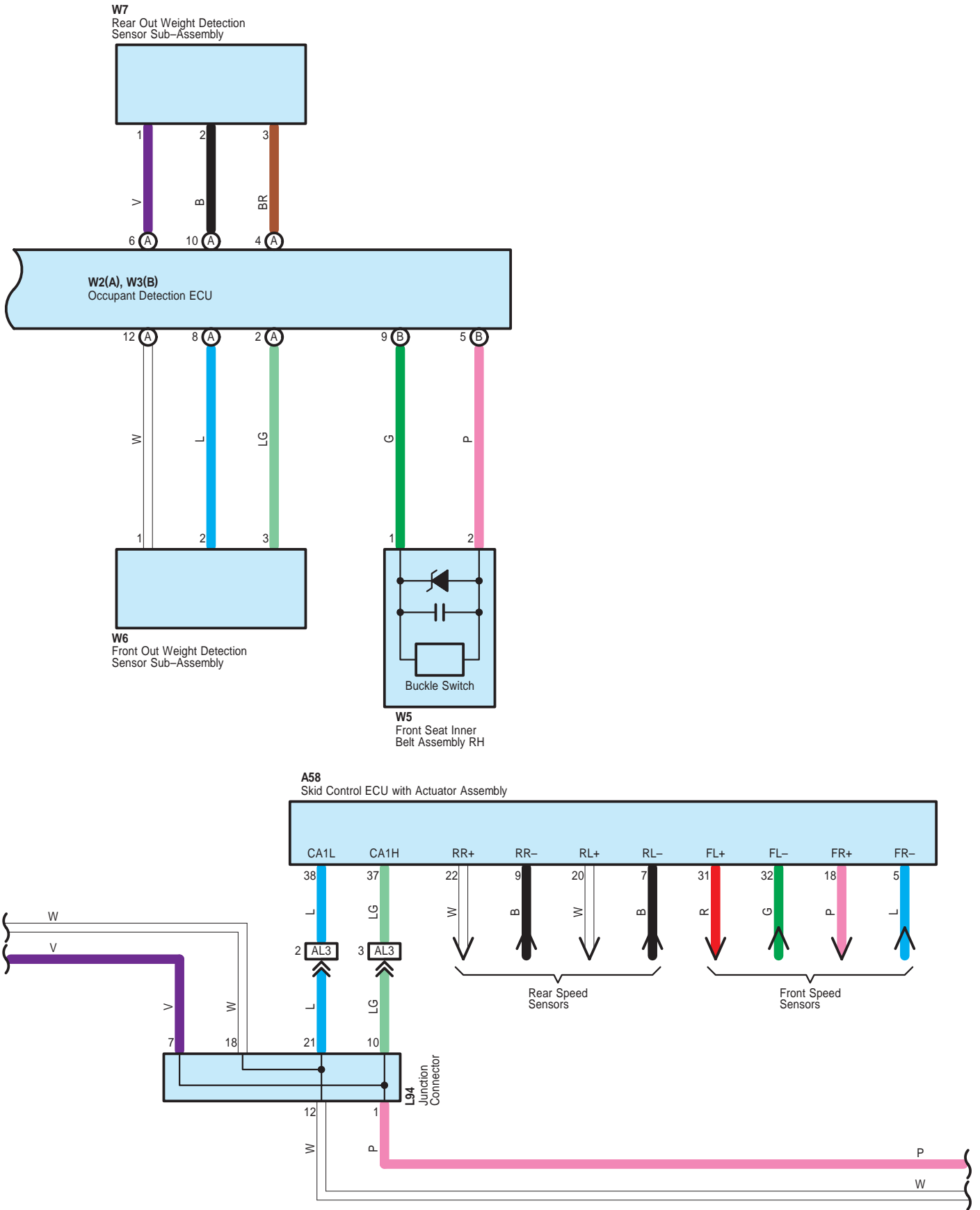

# Seat Belt Warning

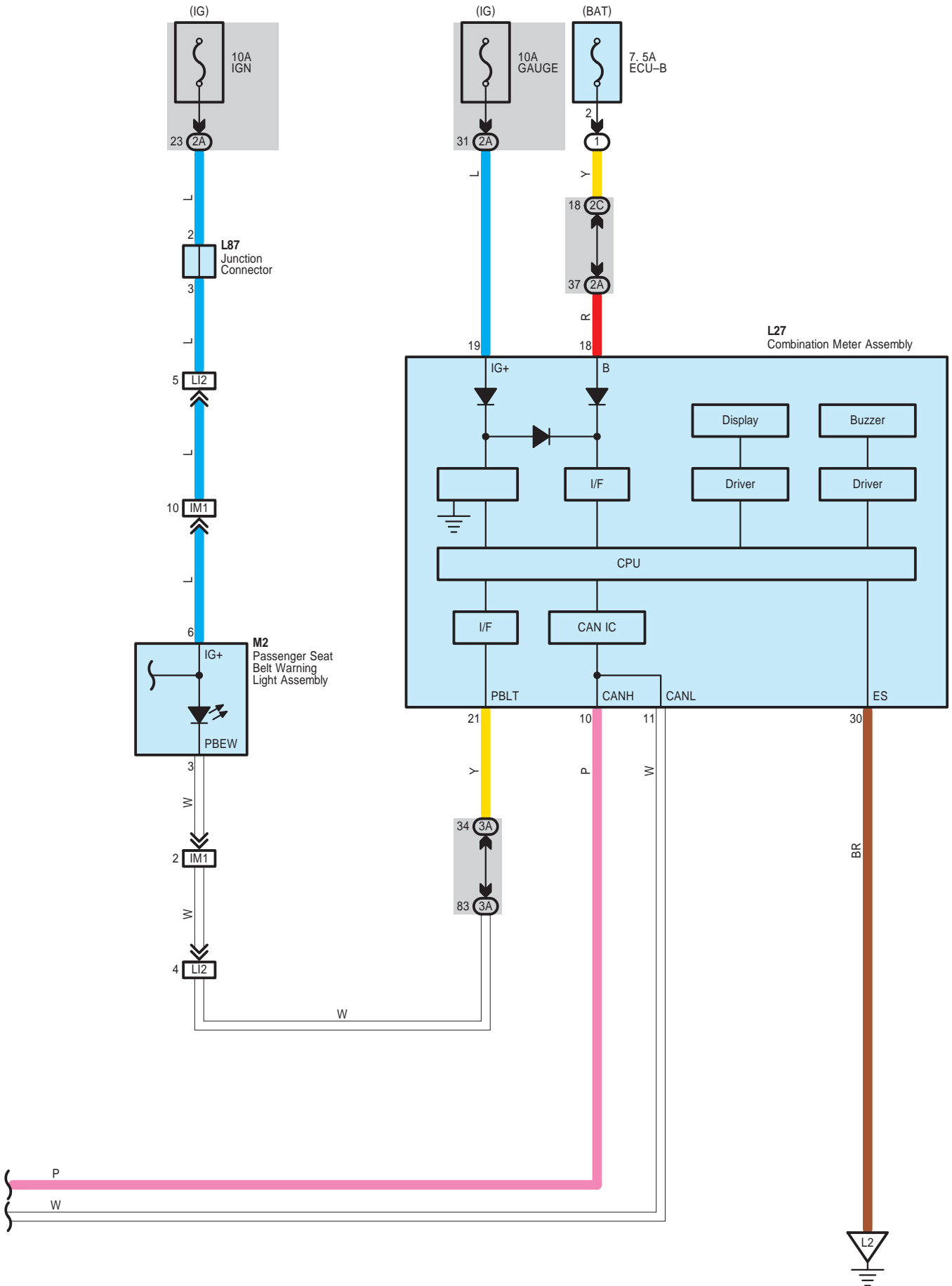

Seat Belt Warning

A 58  
Gray

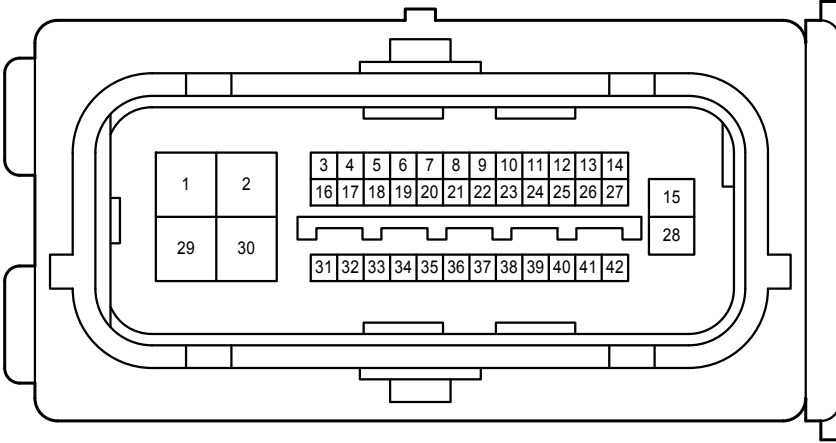

L 16  
Yellow

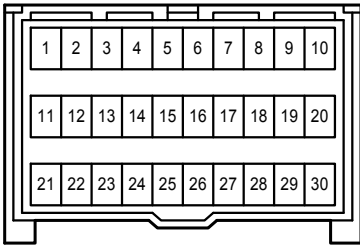

L 27  
White

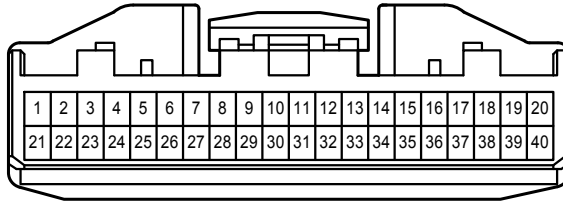

L 87  
Black

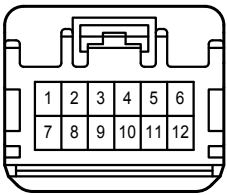

L 94  
White

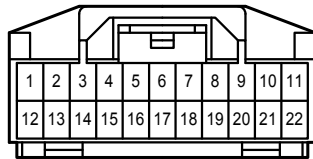

L 95  
White

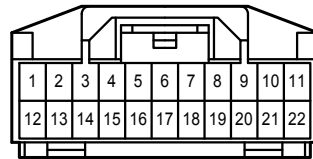

M 2  
White

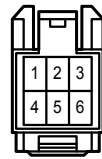

R 1  
Yellow

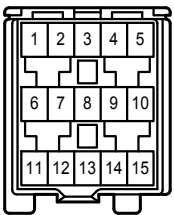

R 4  
White



S 1  
Yellow

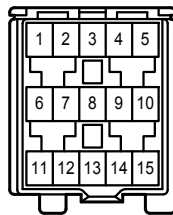

S 20  
White

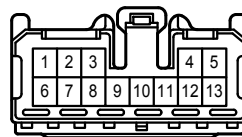

W 1  
Gray

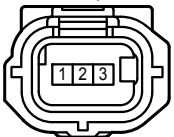

W 2  
Gray

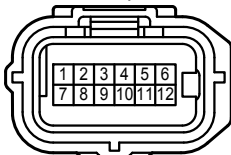

W 3  
Black

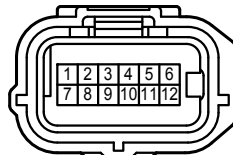

W 4  
Black

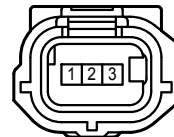



Seat Belt Warning

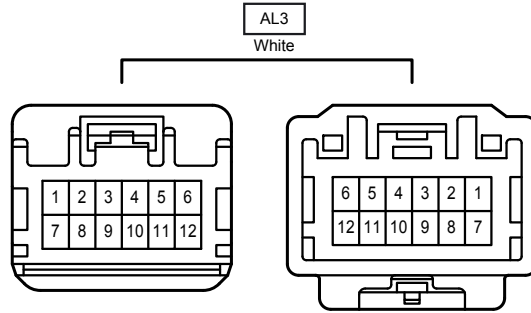
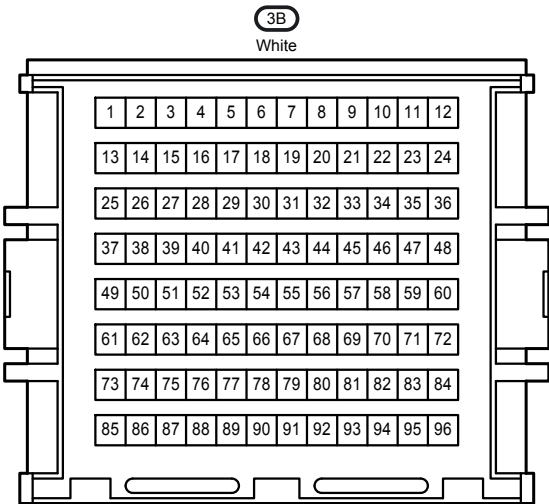
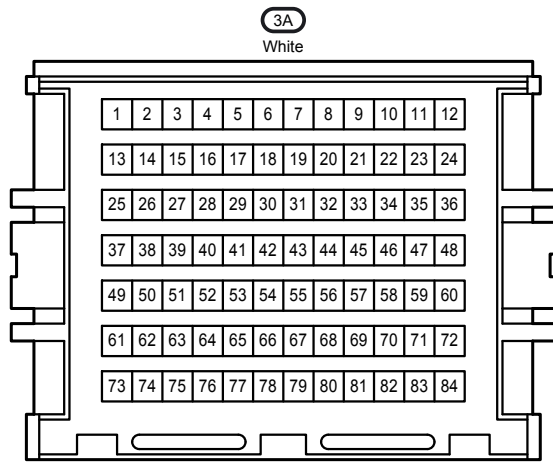
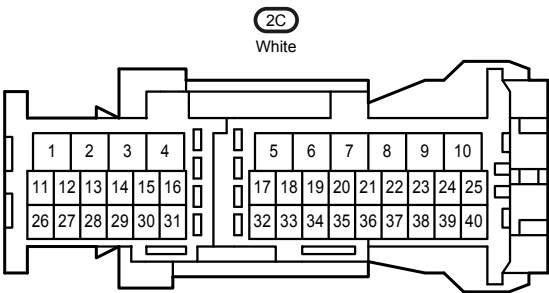
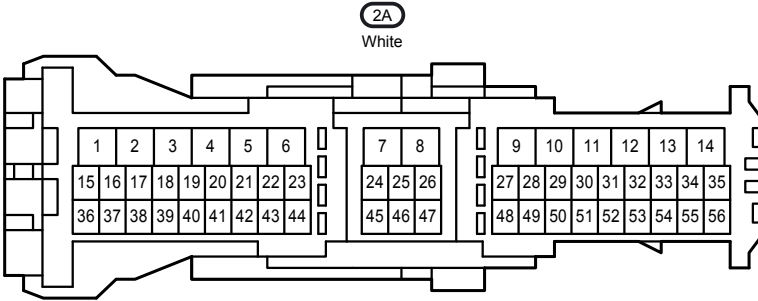
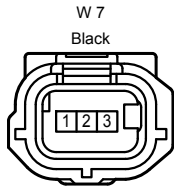
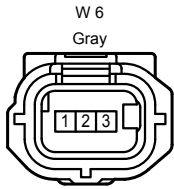

Seat Belt Warning

IM1  
White

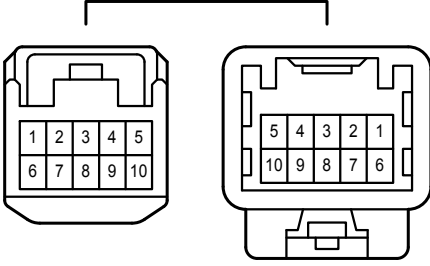

LI2  
White

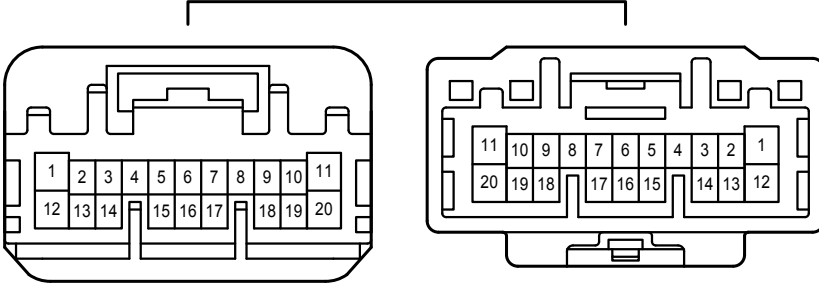

LS1  
White

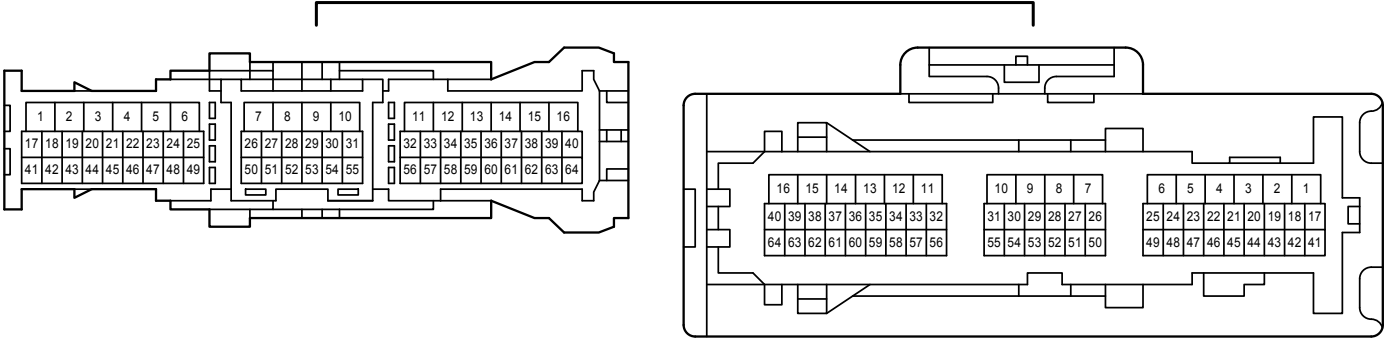

SW1  
Gray

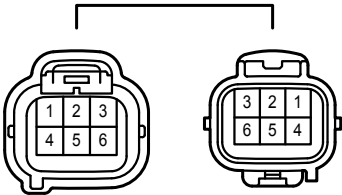

# Seat Heater

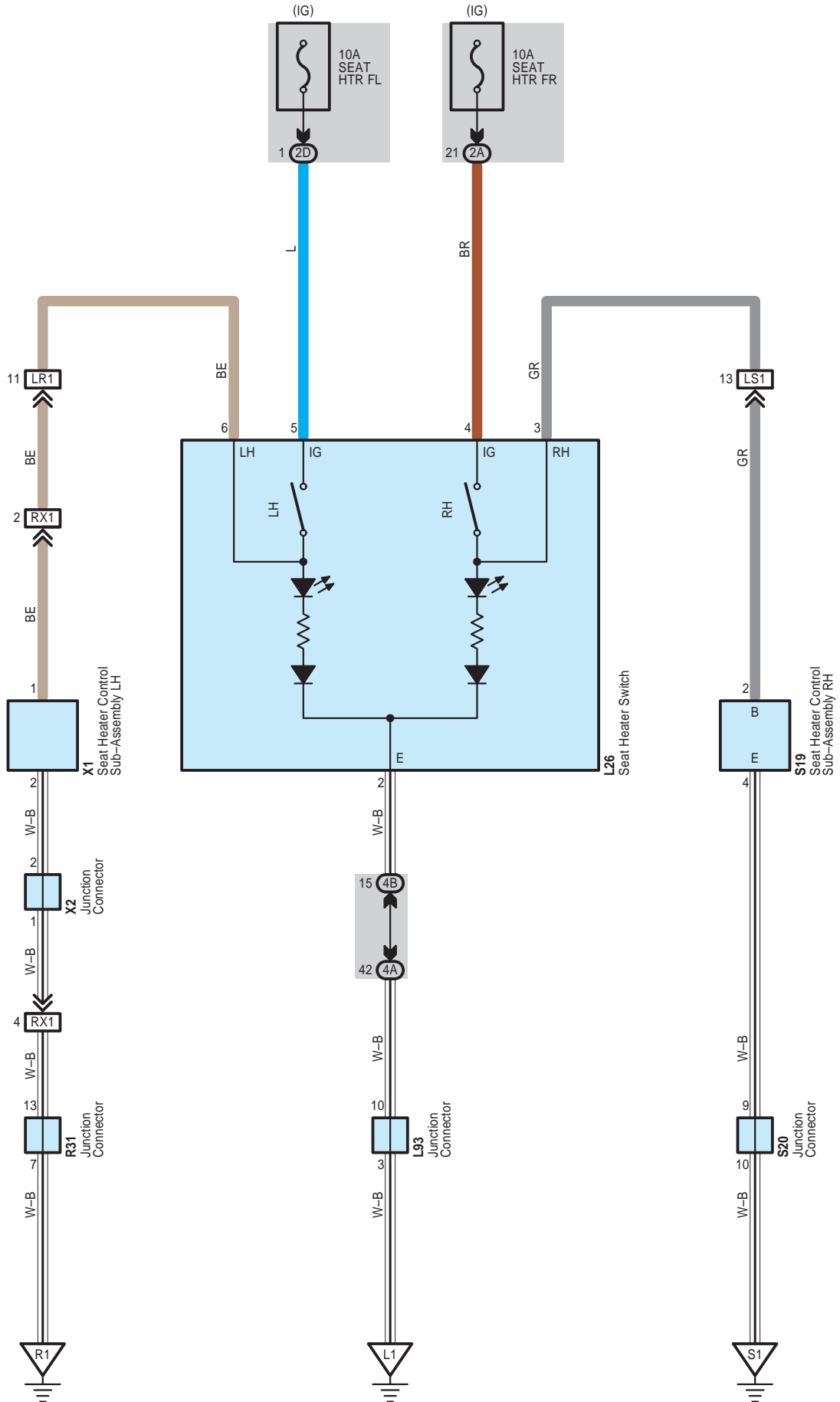

Seat Heater

L 26  
Black



L 93  
White

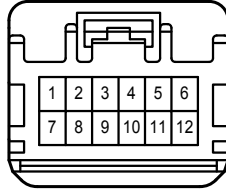

R 31  
White

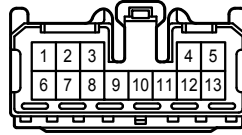

S 19  
White

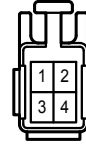

S 20  
White

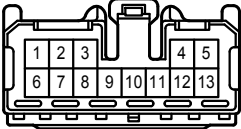

X 1  
White

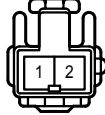

X 2  
Black

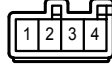

2A  
White

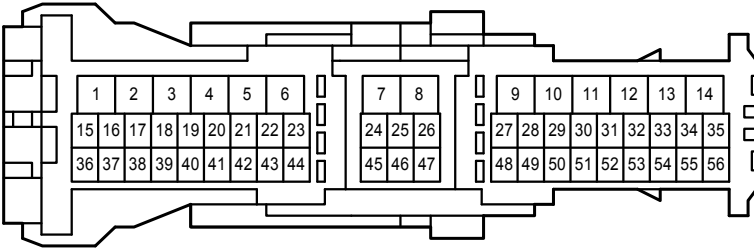

2D  
White

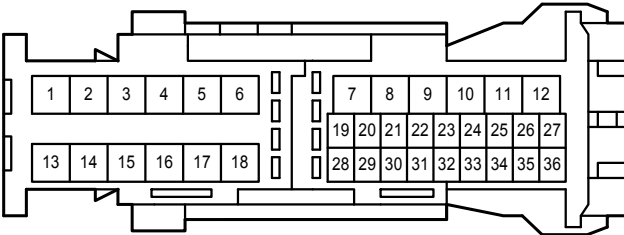

4A  
White

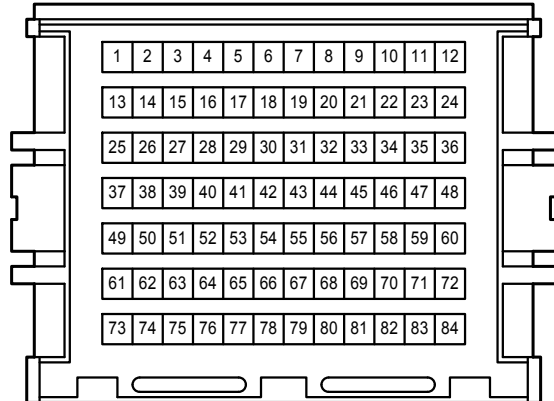

4B  
White

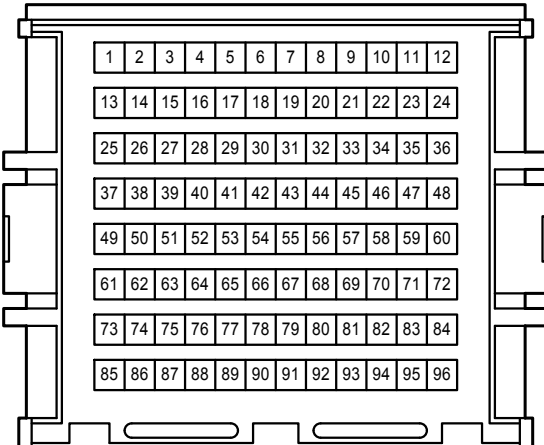

Seat Heater

LR1  
White

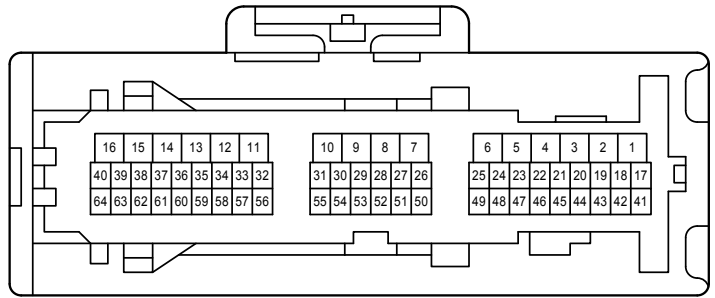
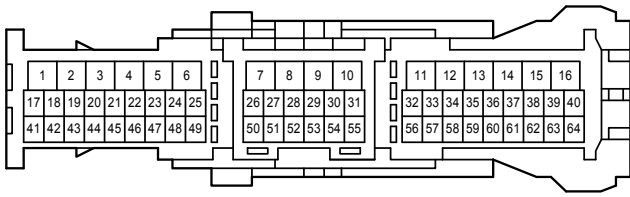

LS1  
White

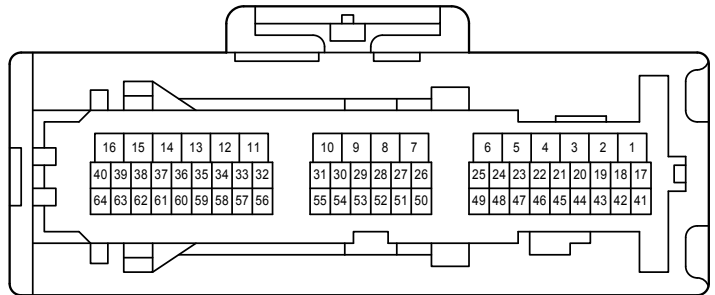
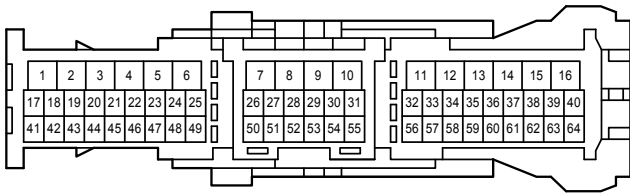

RX1  
White

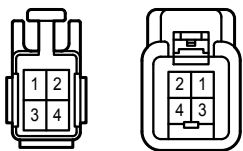



# Sliding Roof

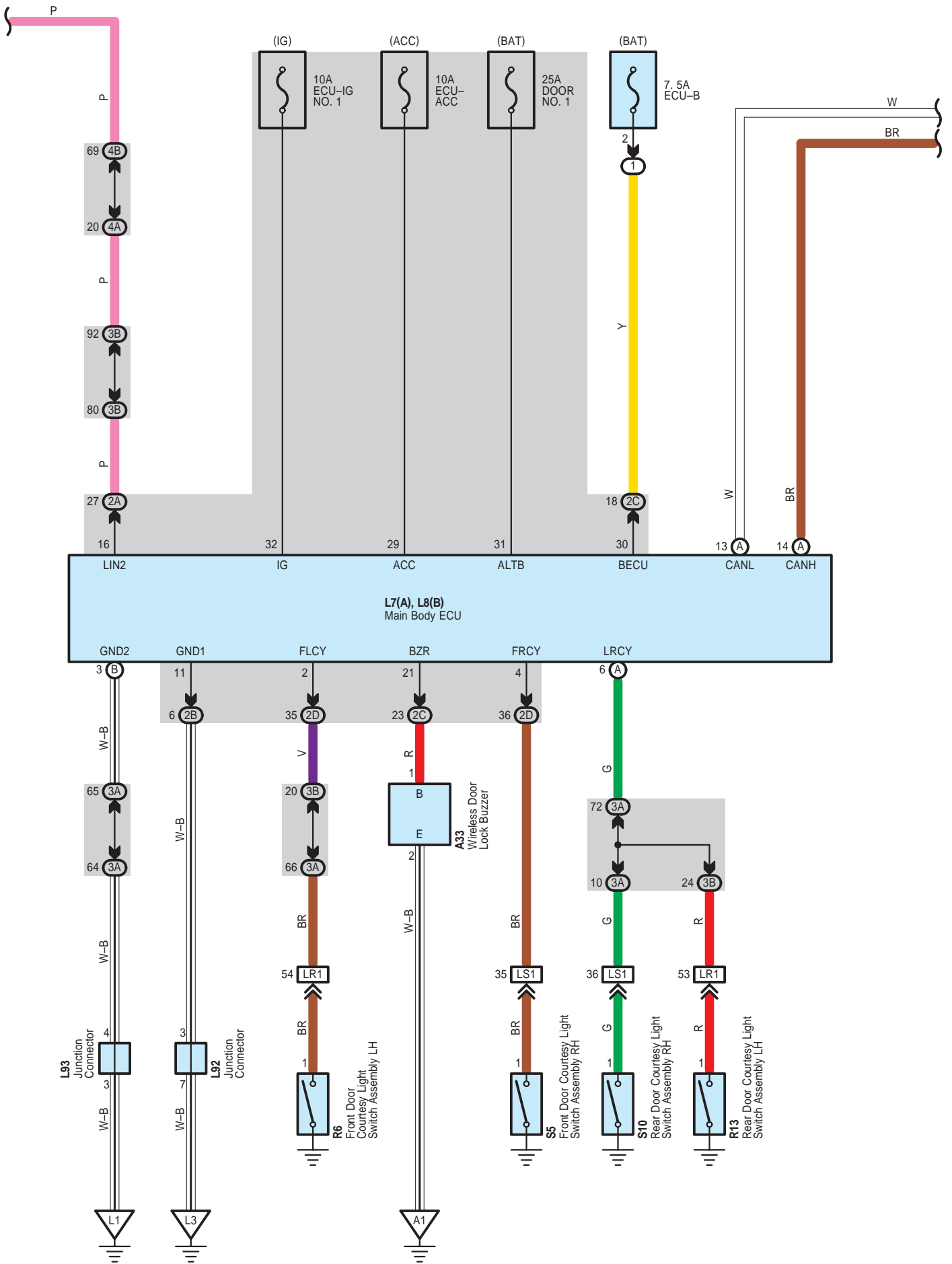

# Sliding Roof

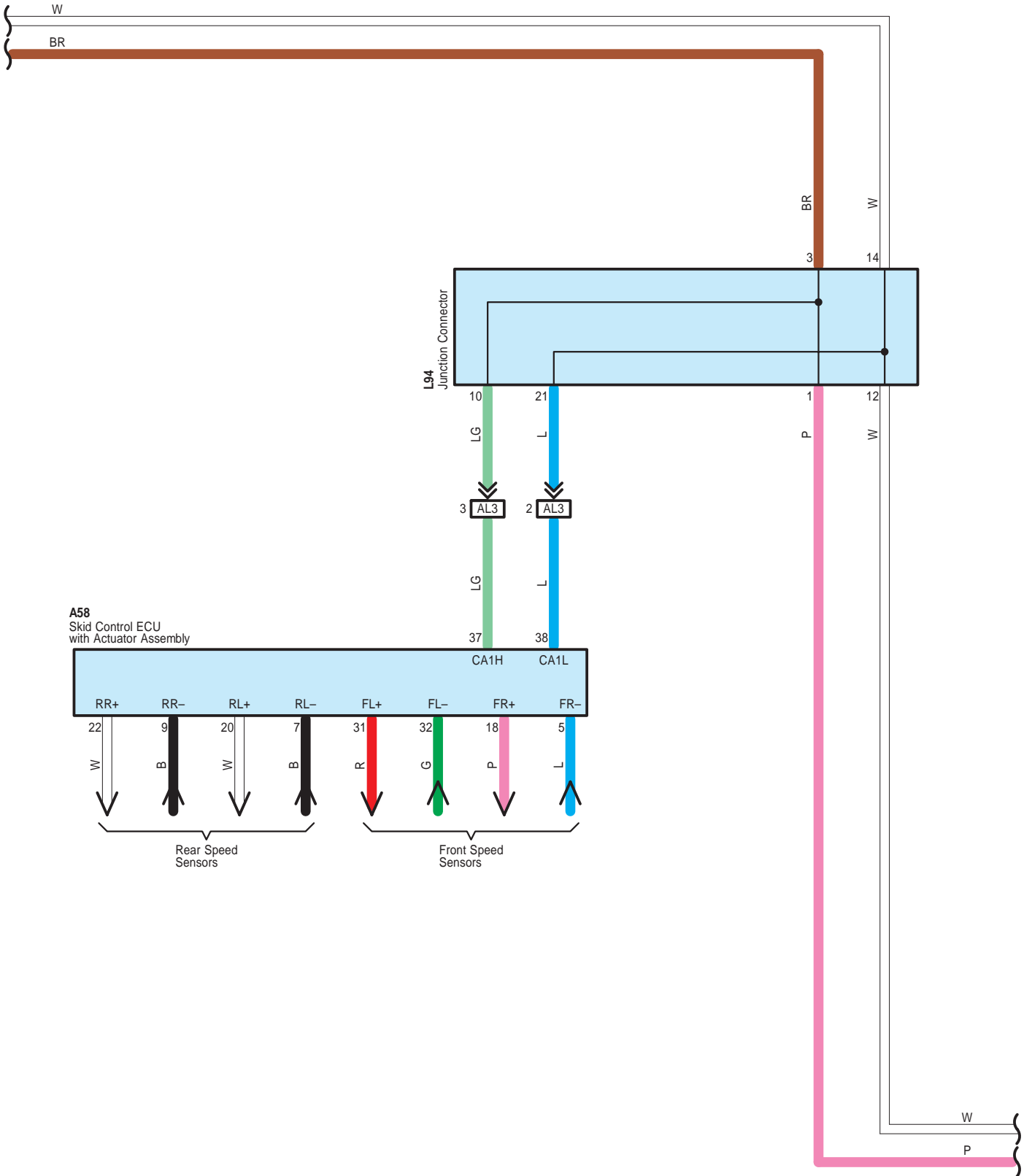



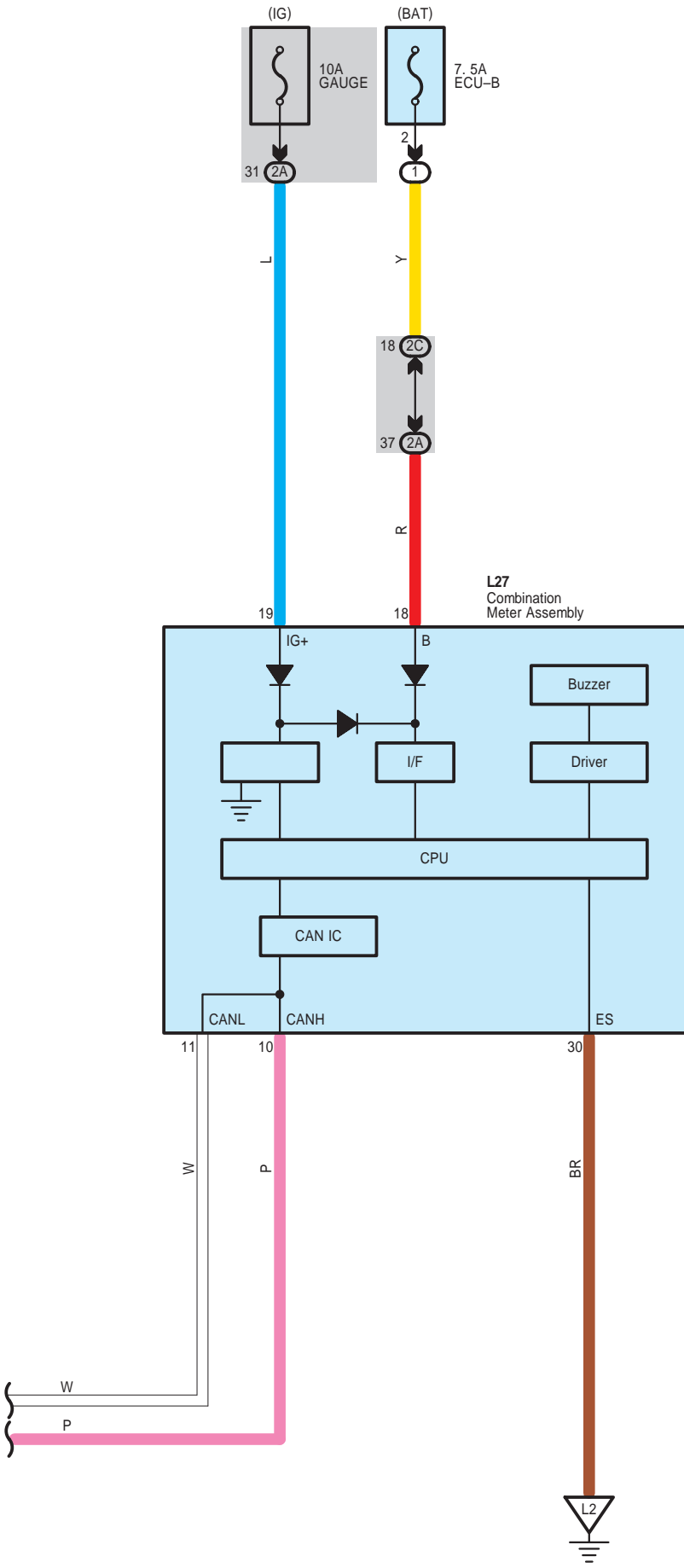

Sliding Roof

A 33  
Gray



A 58  
Gray

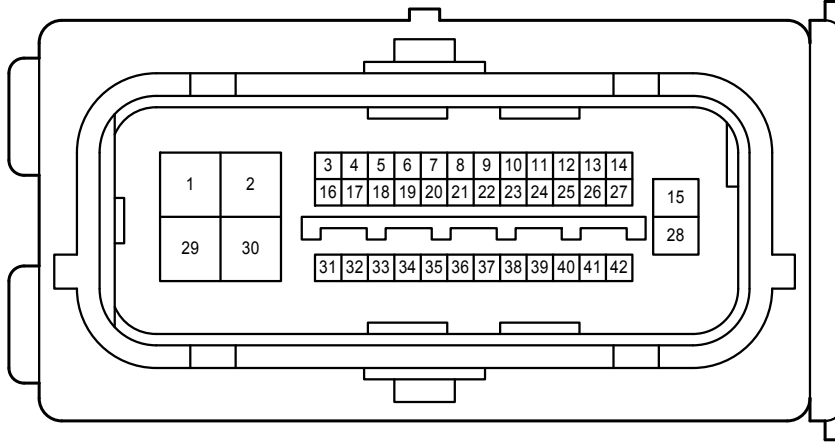

L 7  
White

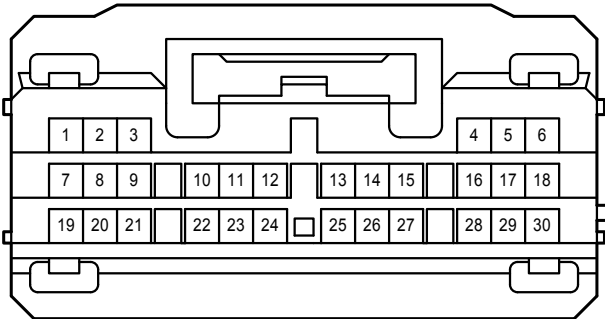

L 8  
White

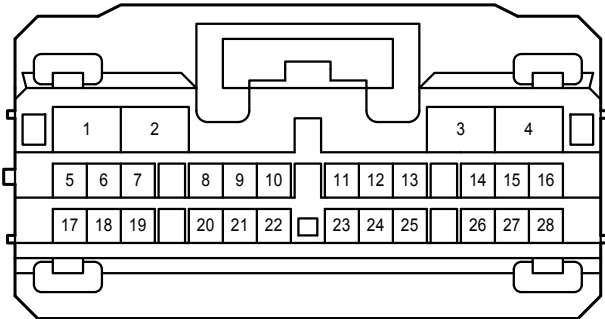

L 27  
White

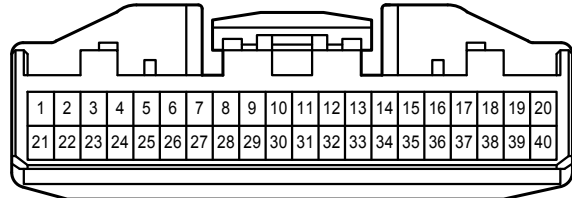

L 92  
White

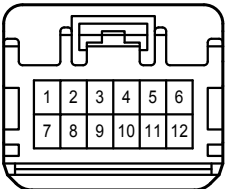

L 93  
White

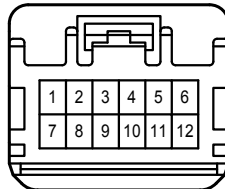

L 94  
White

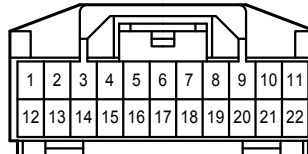

R 6  
Black



Sliding Roof

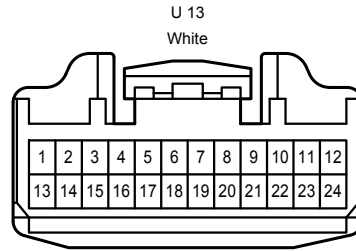
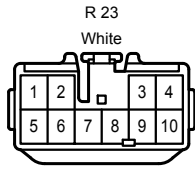

2A  
White

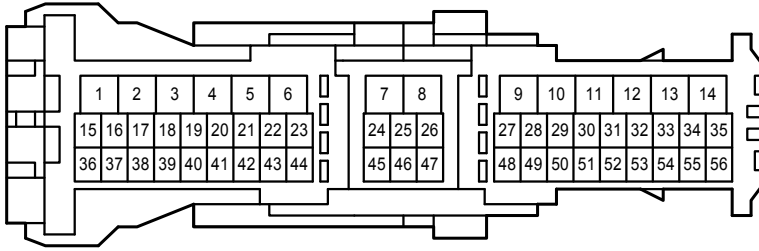

2B  
White

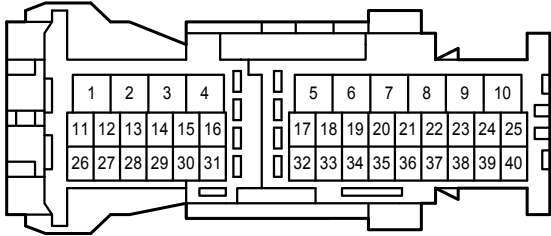

2C  
White

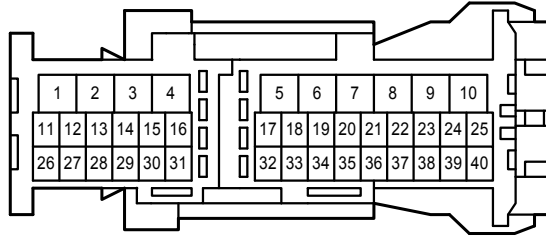

2D  
White

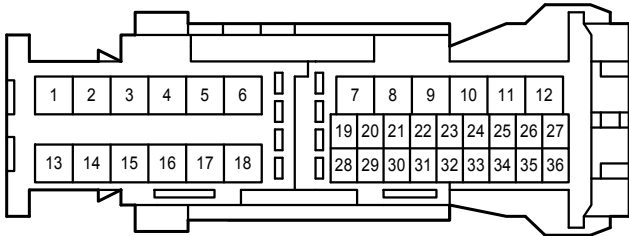

3A  
White

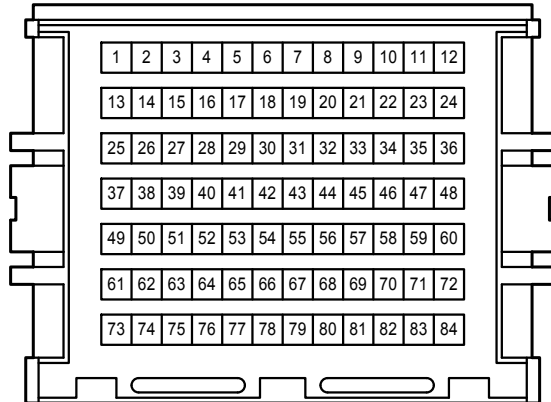

Sliding Roof

3B  
White

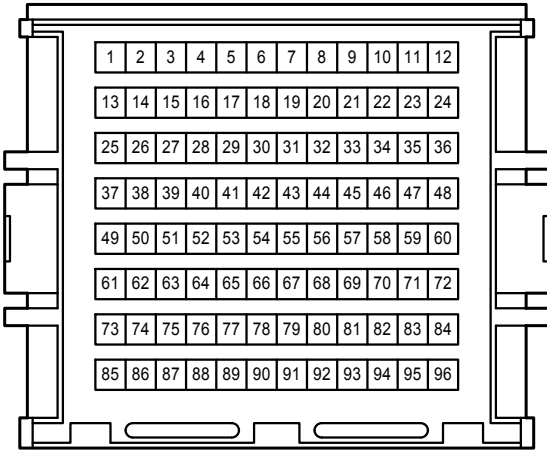

4A  
White

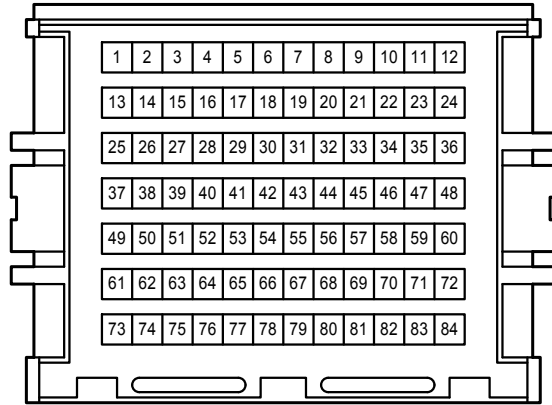

4B  
White

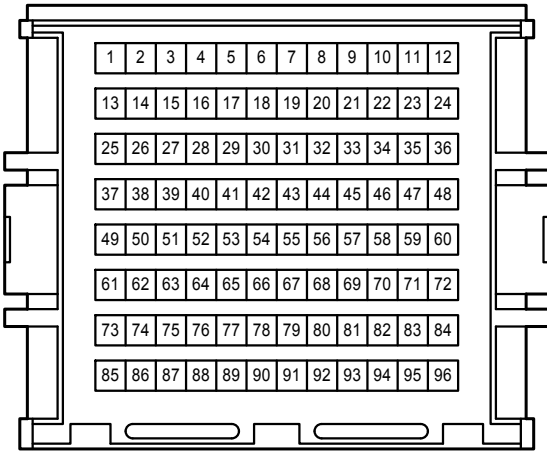

AL3  
White

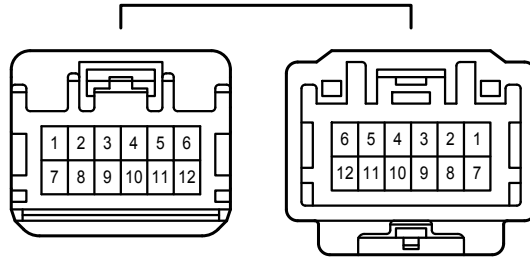

LR1  
White

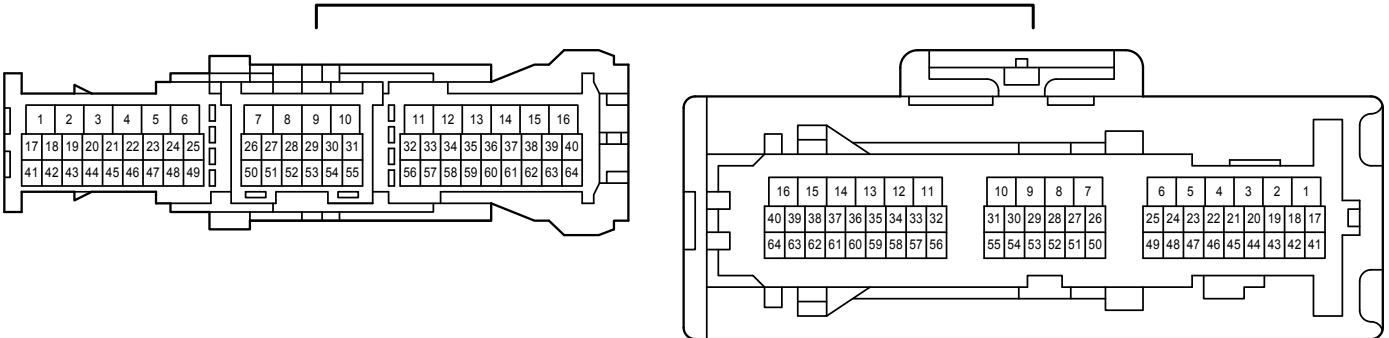

# Sliding Roof

LS1  
White

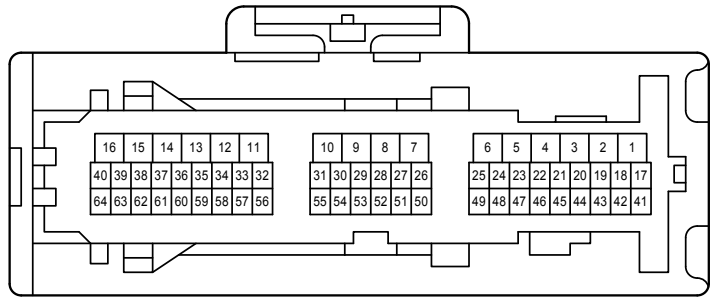
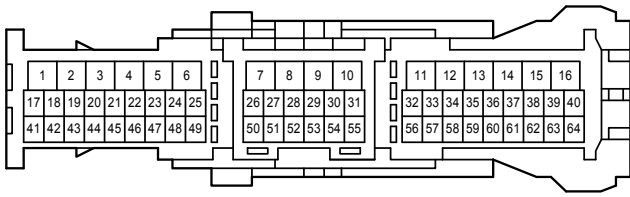

UL1  
Gray

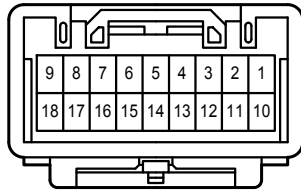
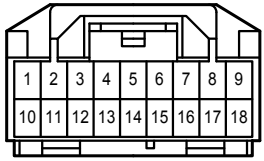

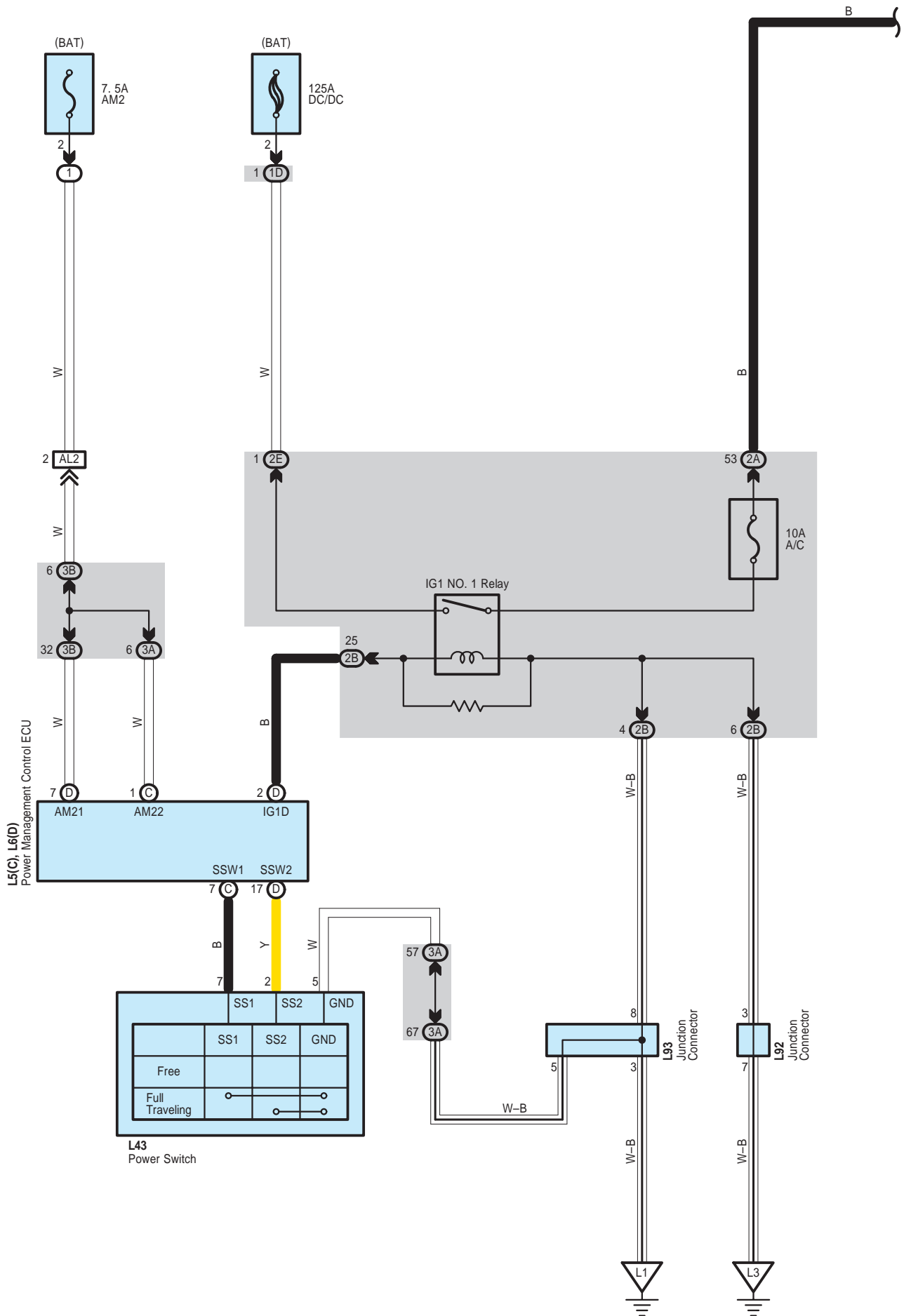

# Solar Ventilation System

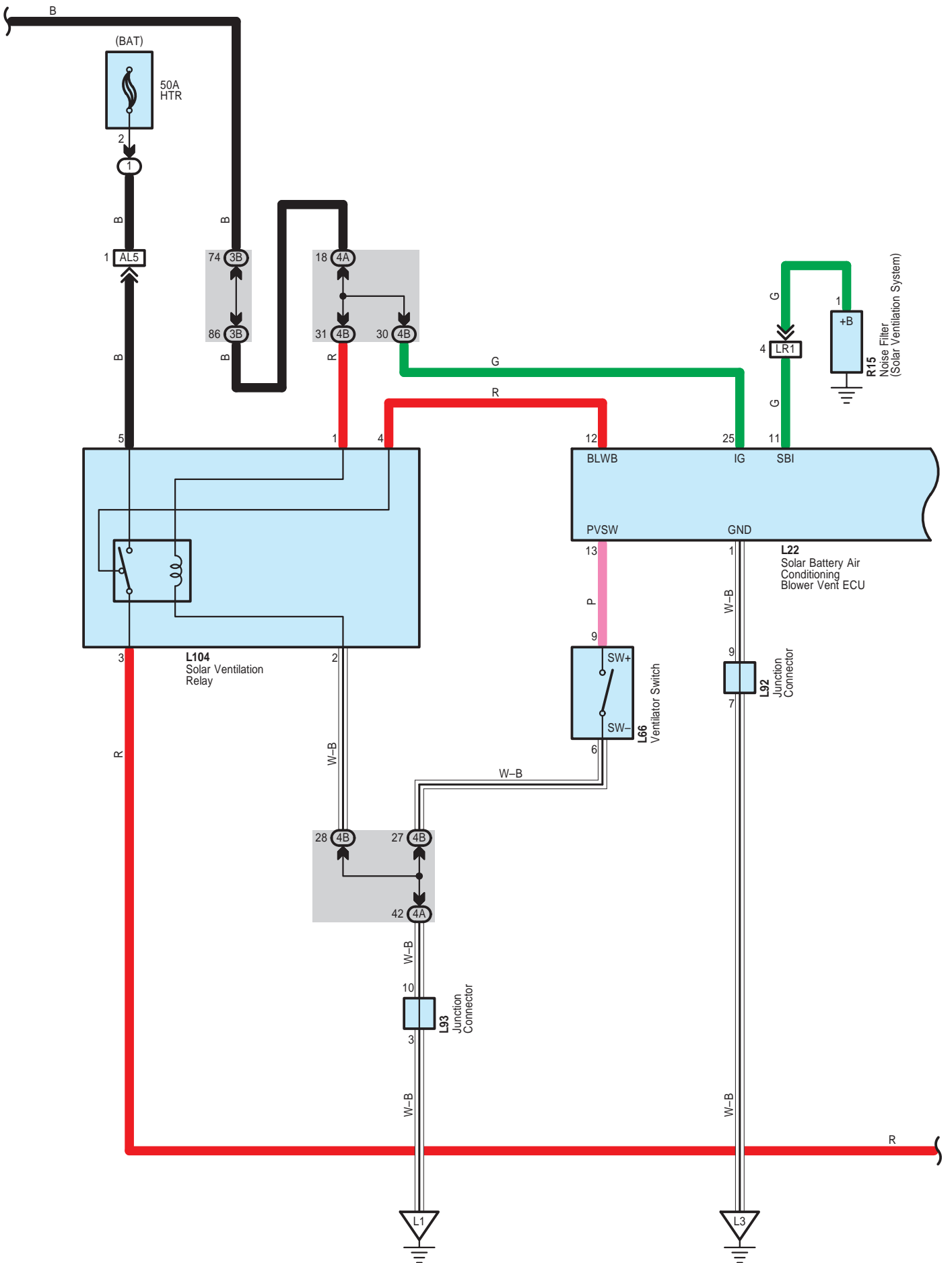

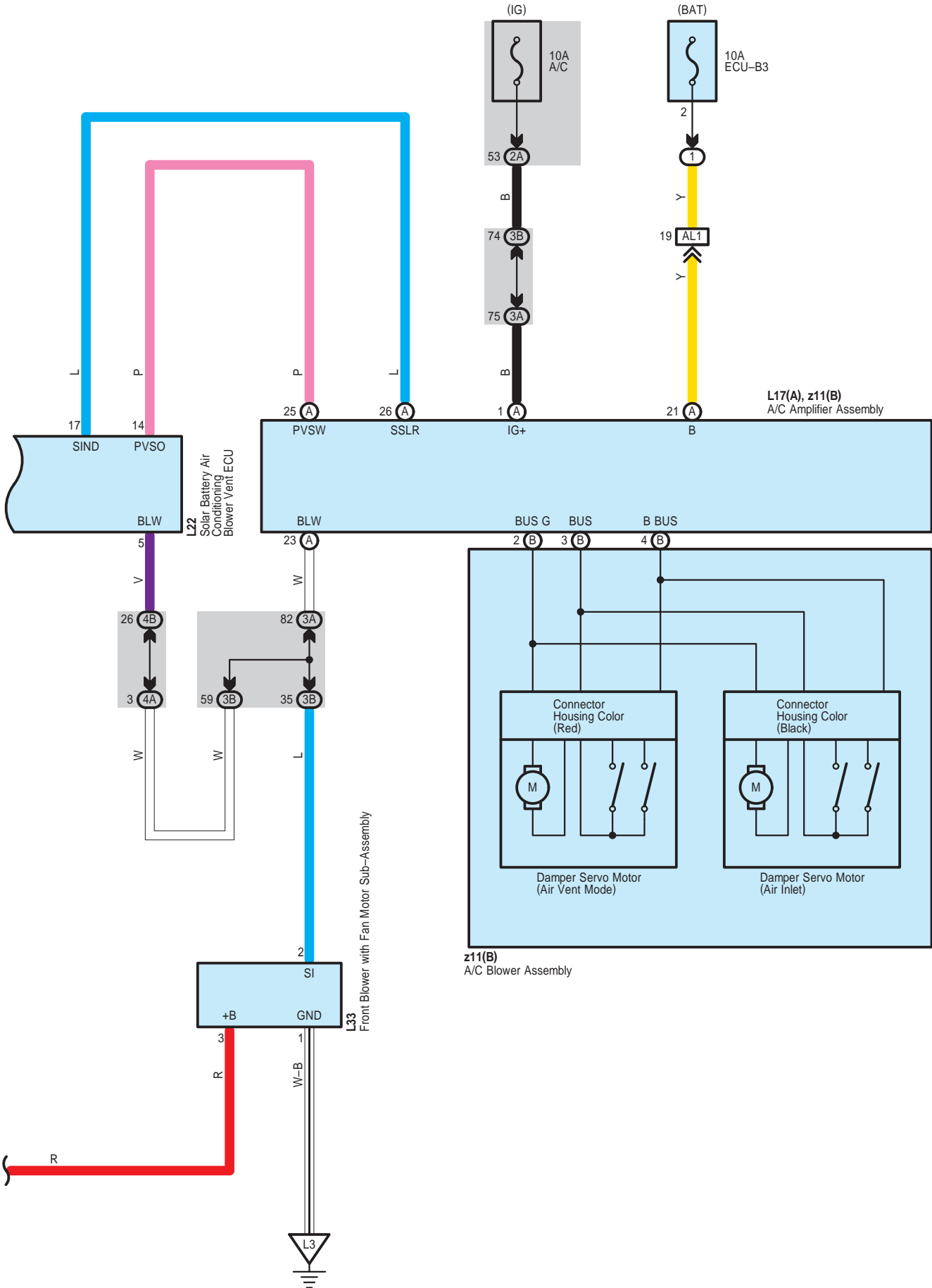



Solar Ventilation System

L 5  
Gray

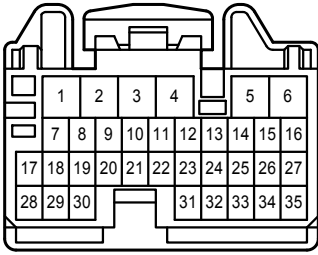

L 6  
Gray

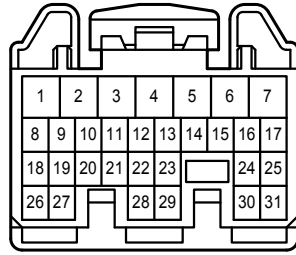

L 17  
White

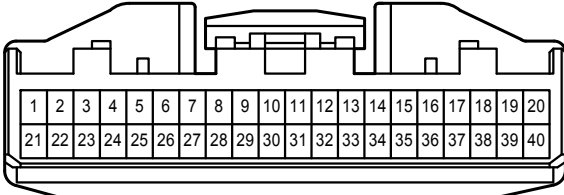

L 22  
Black

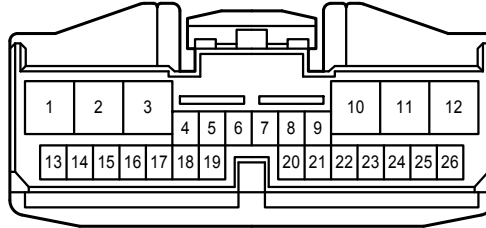

L 33  
Black

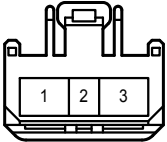

L 43  
Black

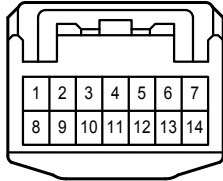

L 66  
White

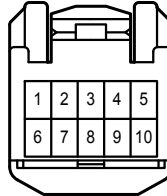

L 92  
White

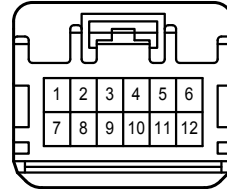

L 93  
White

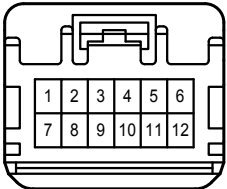

L104  
White

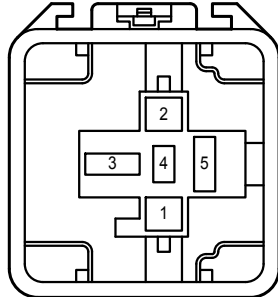

R 15  
White



z 11  
White

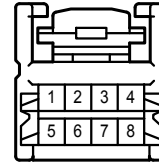

1D  
Black

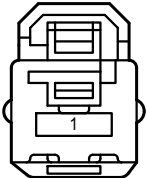

2A  
White

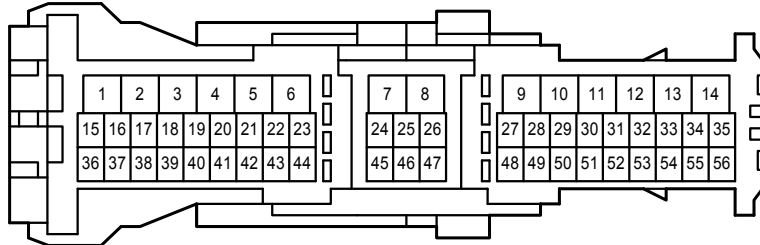



Solar Ventilation System

AL2  
Gray

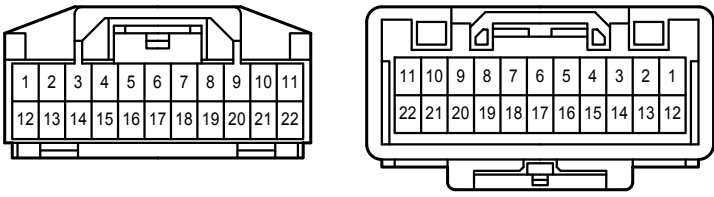

AL5  
White

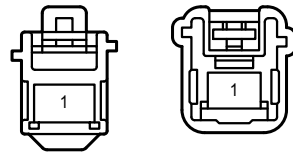

LR1  
White

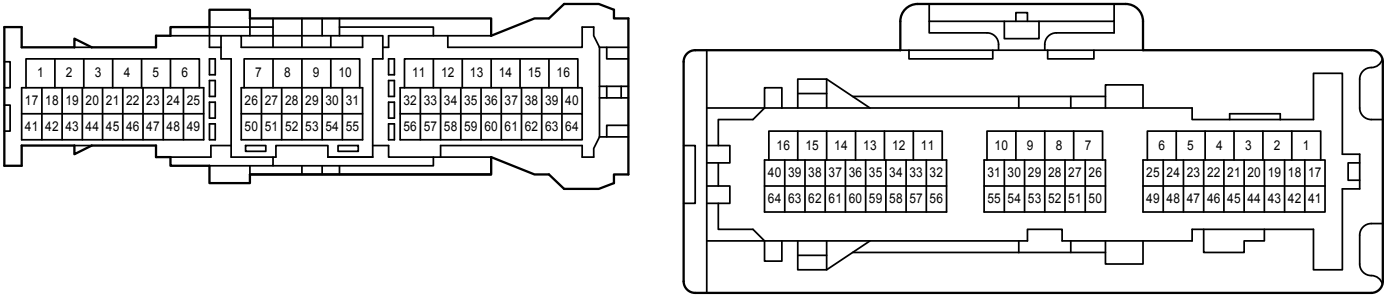

\* 1 : w/ Safety Connect System

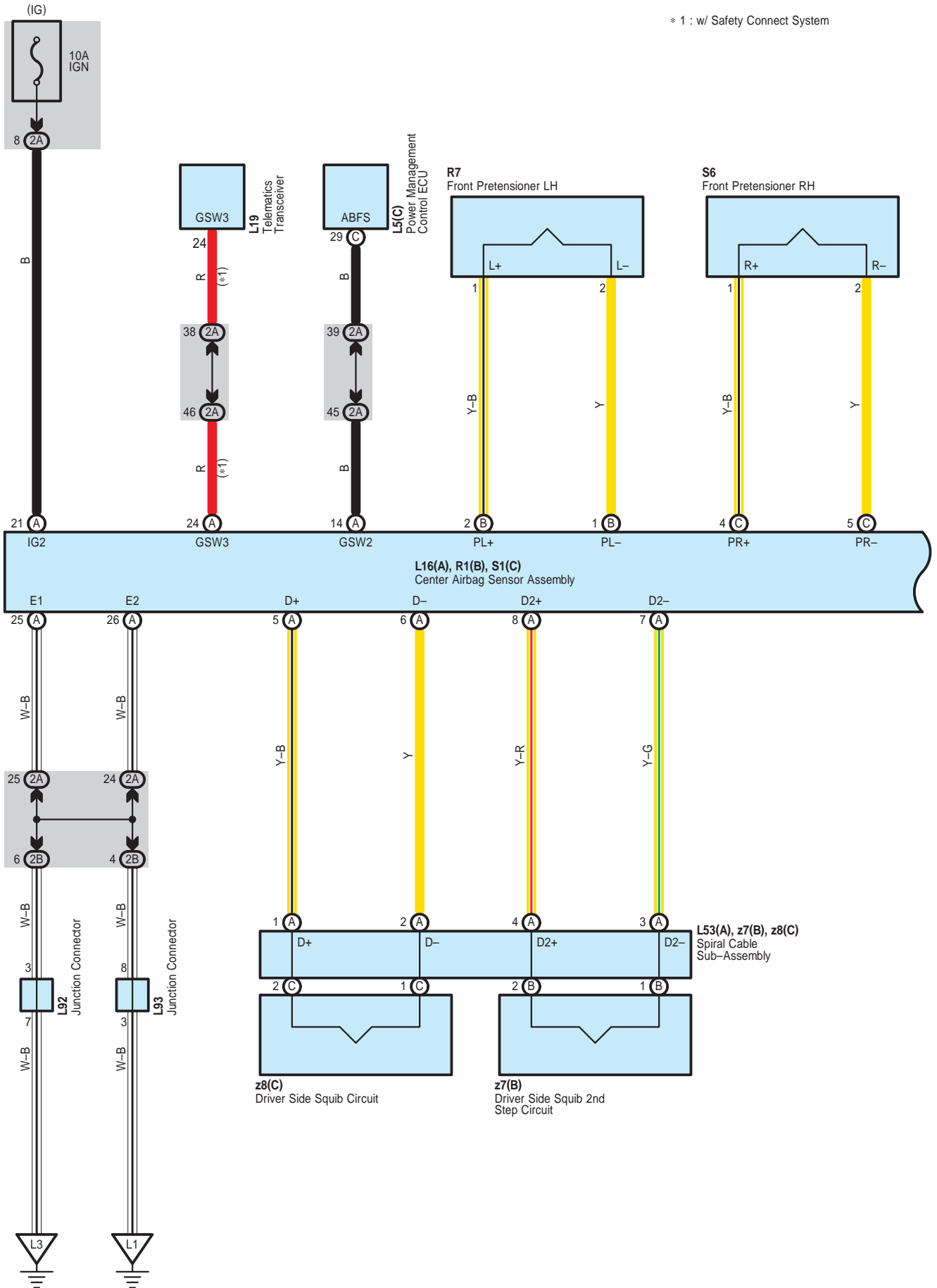

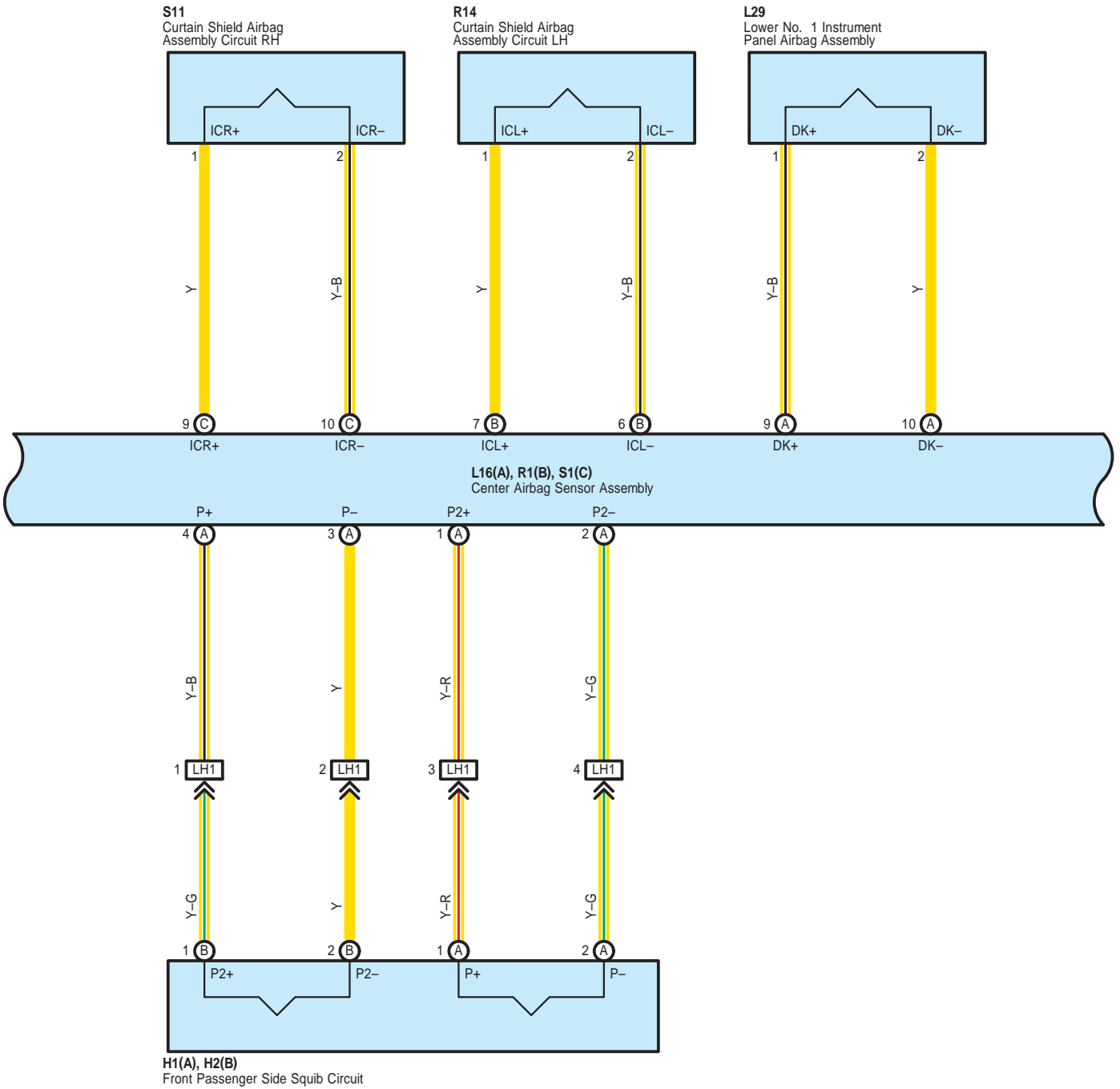

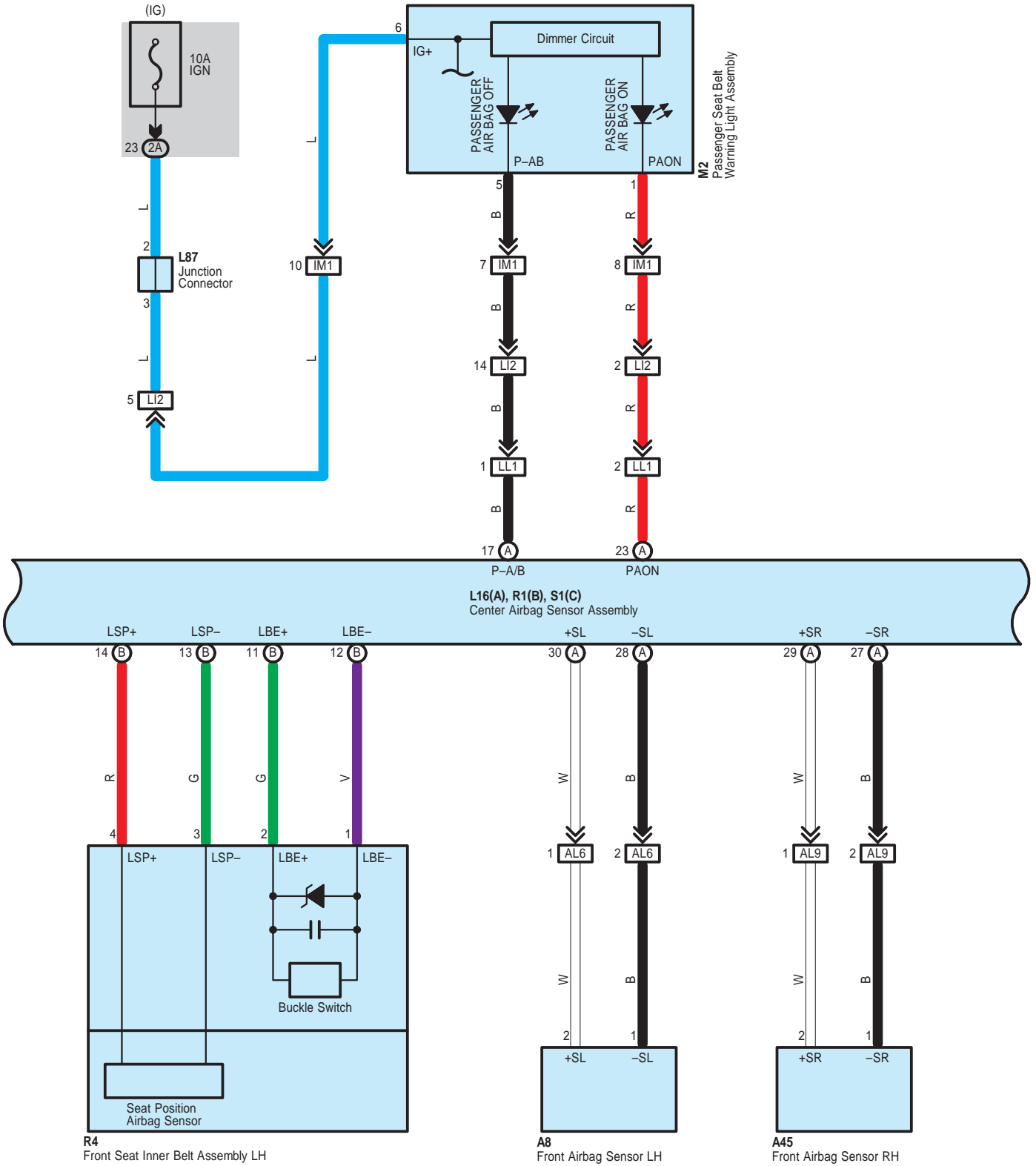

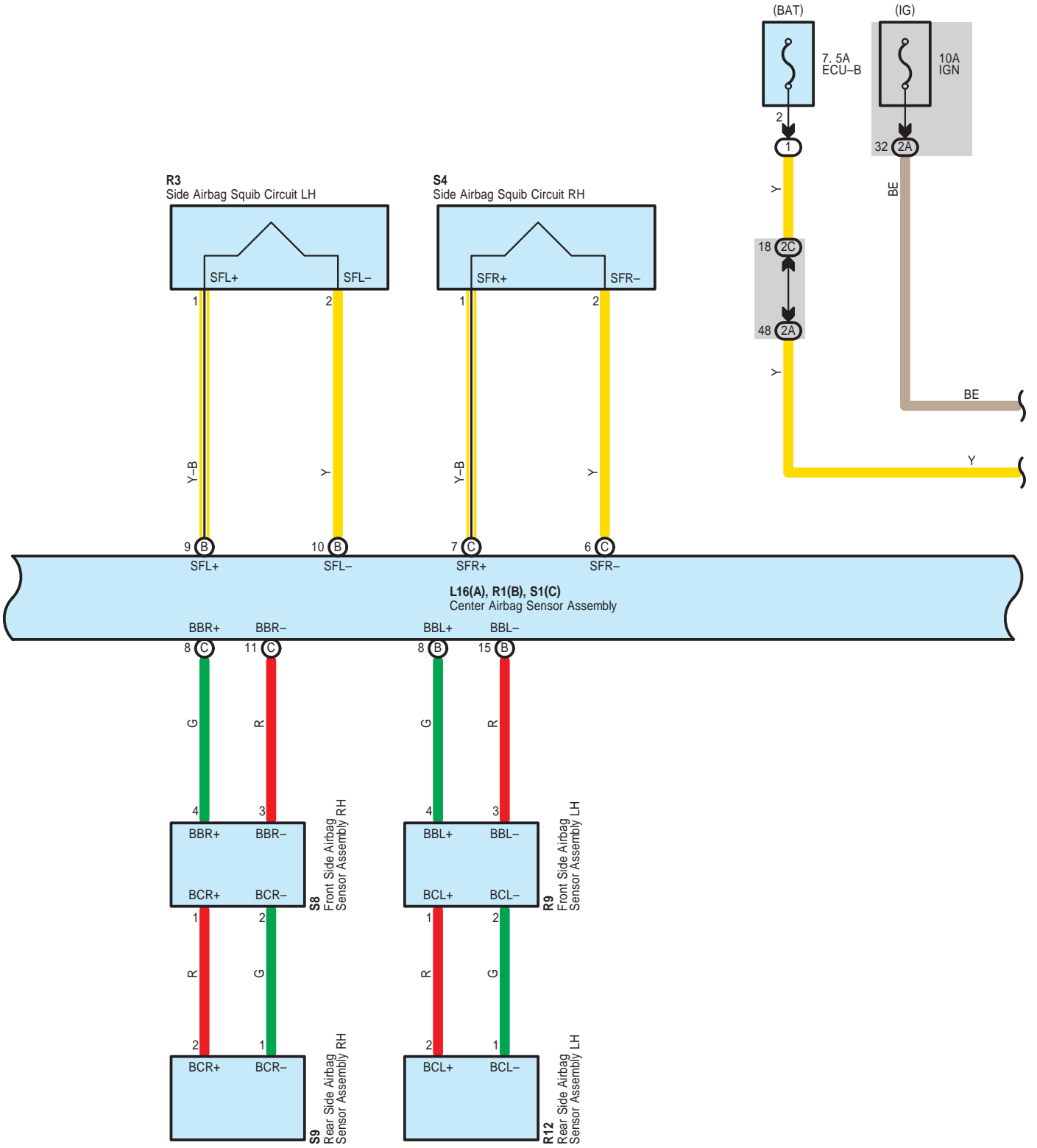

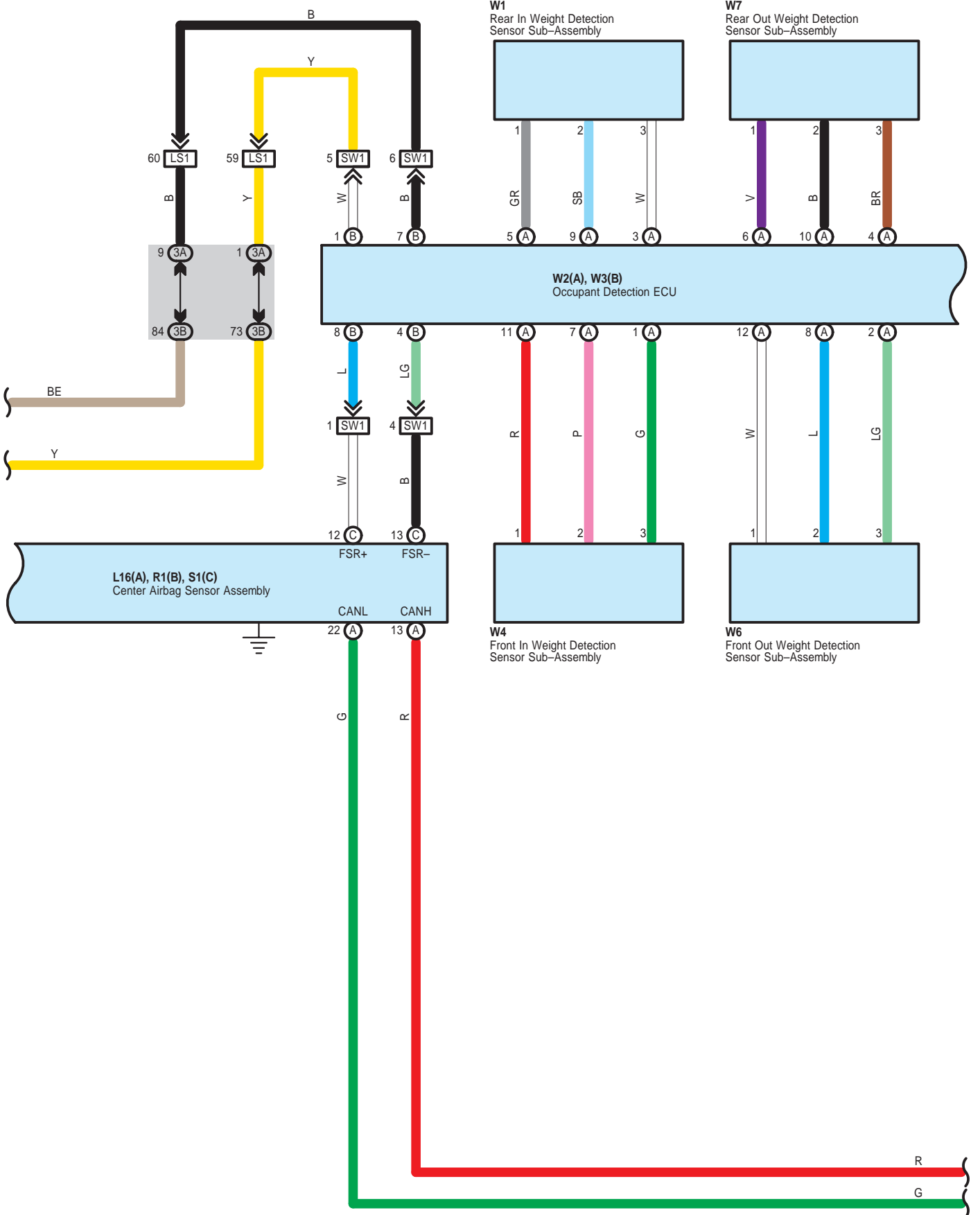



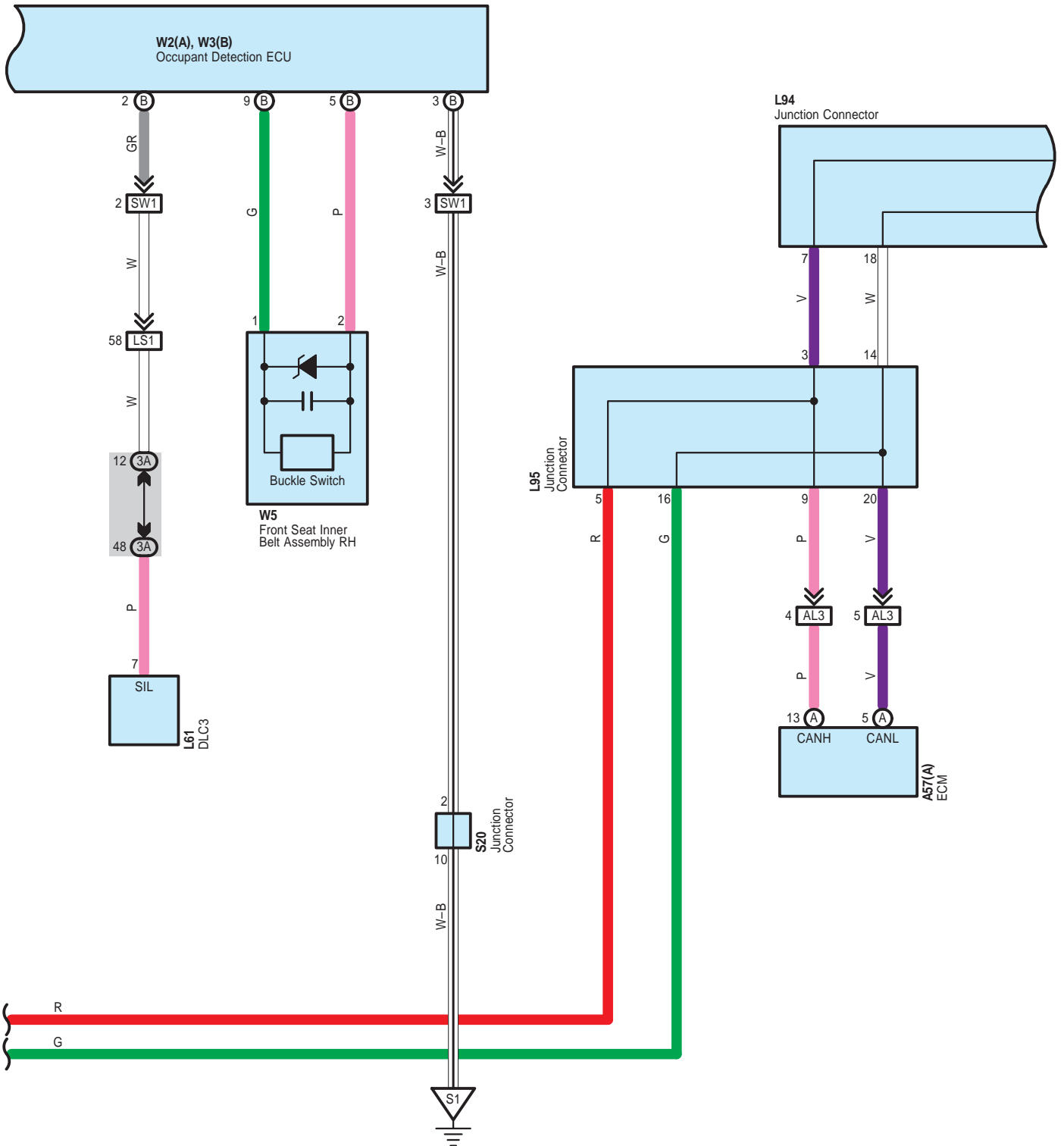

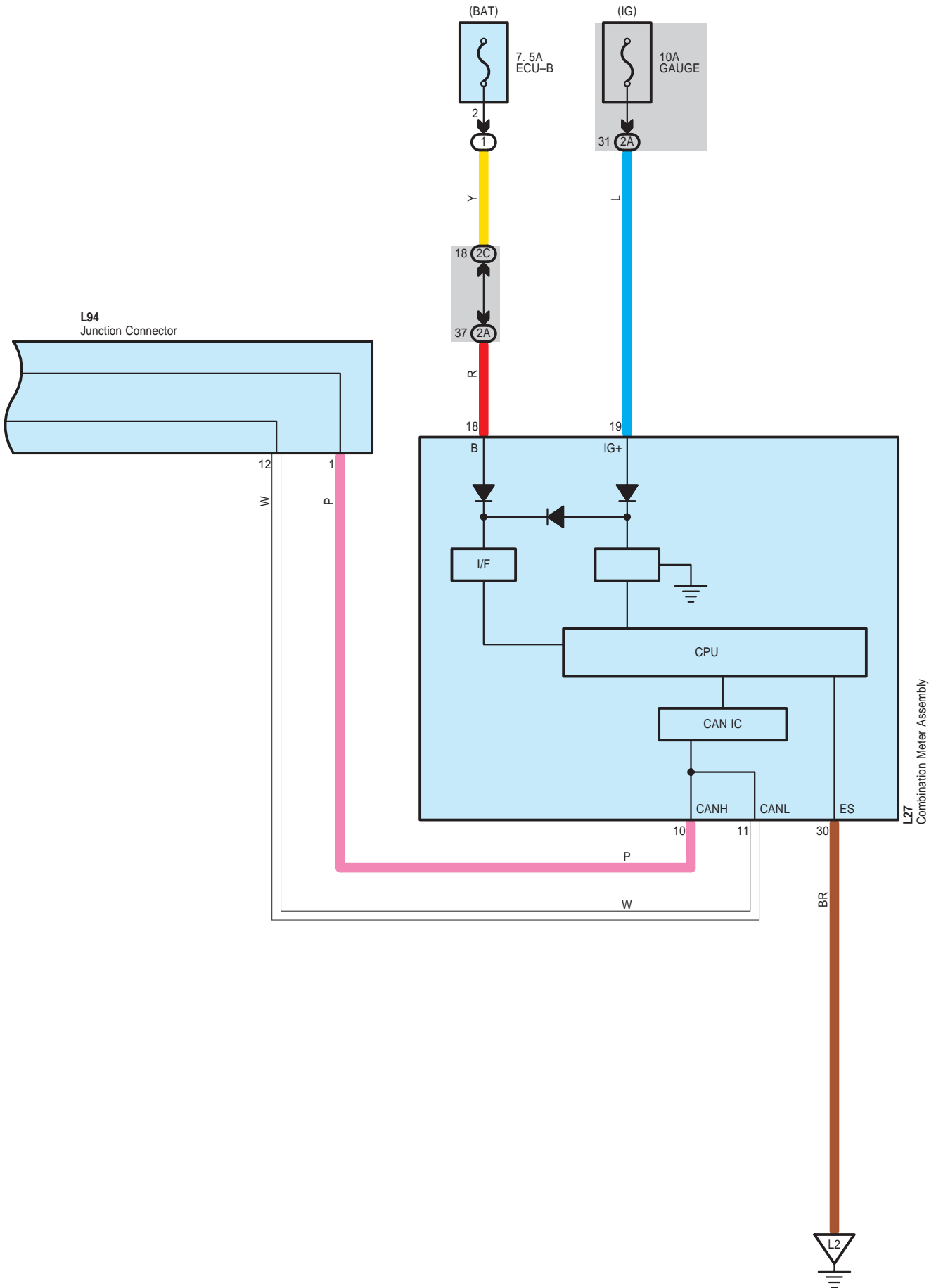

A 8  
Yellow

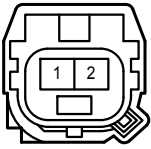

A 45  
Yellow

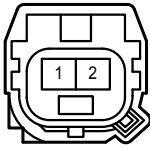

A 57  
Black

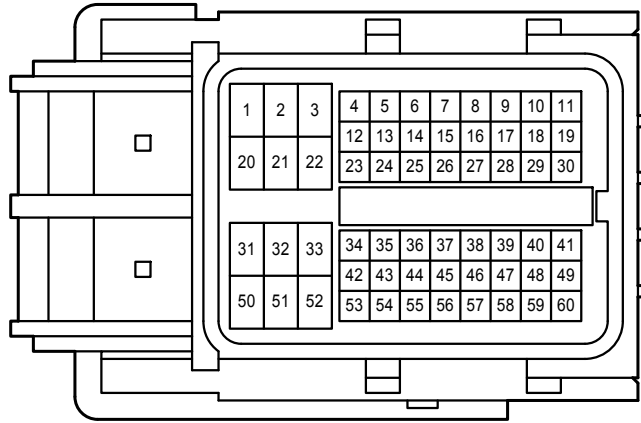

H 1  
Black

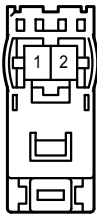

H 2  
Orange

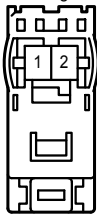

L 5  
Gray

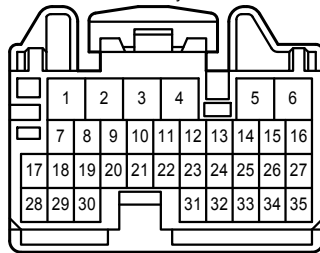

L 16  
Yellow

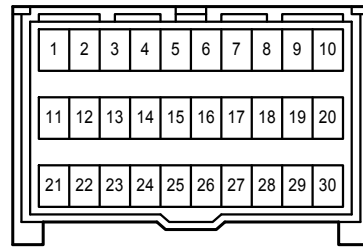

L 19  
White

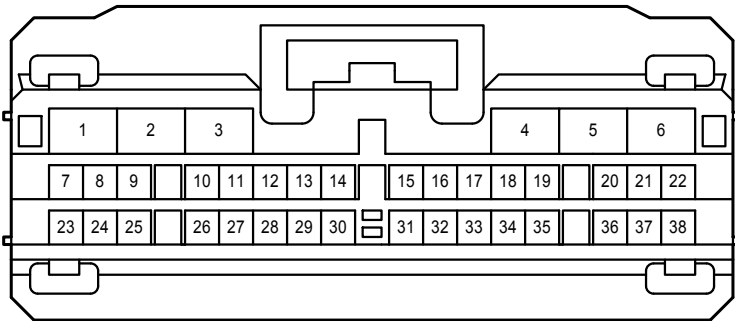

L 27  
White

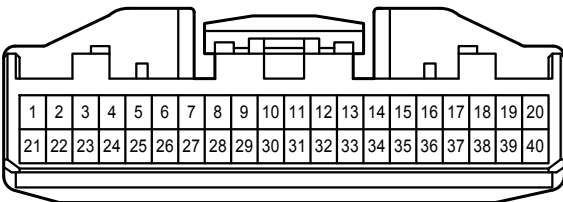

L 29  
Black

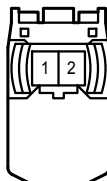

L 53  
Yellow

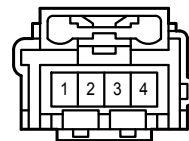

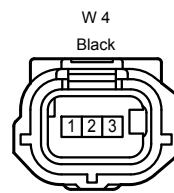
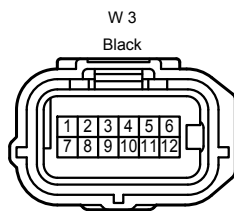
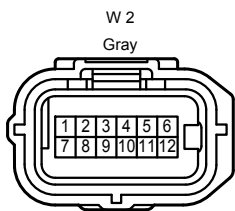
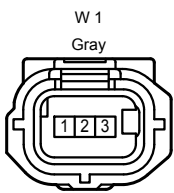
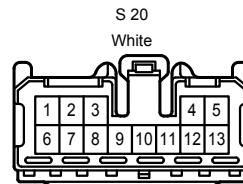
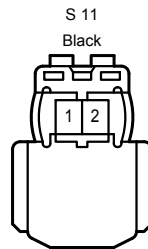
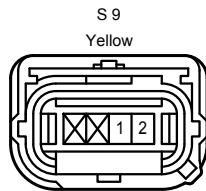
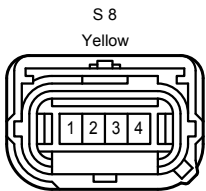
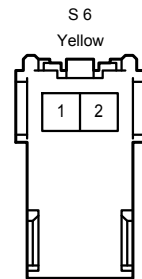
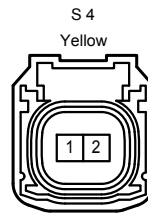
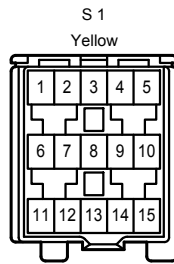
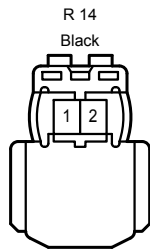
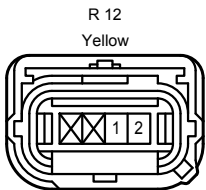
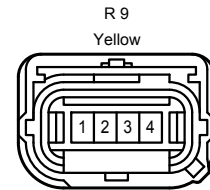
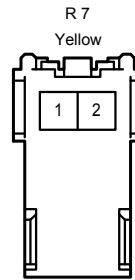
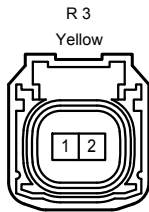
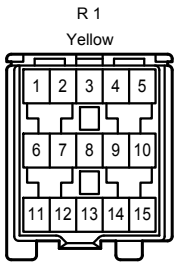
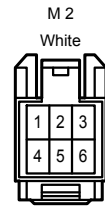
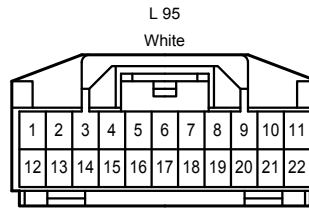
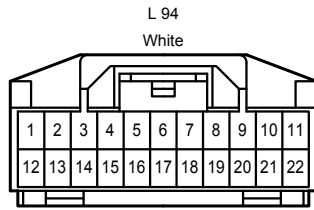
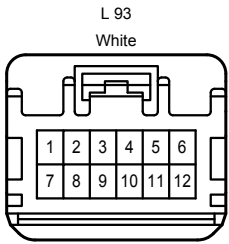
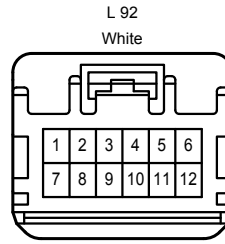
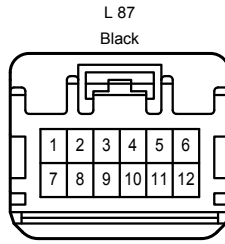
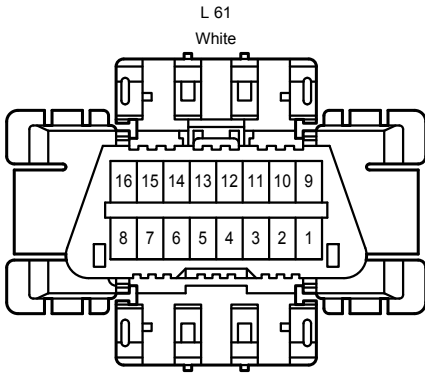

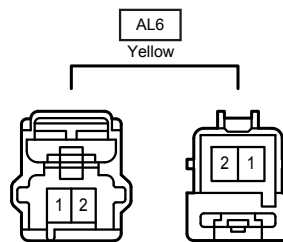
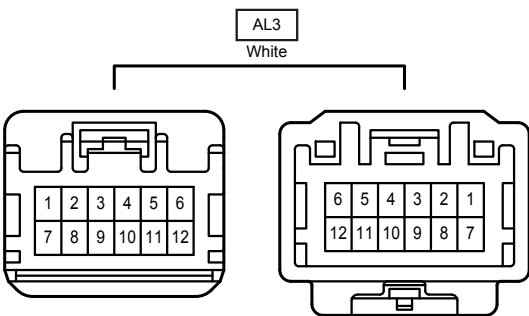
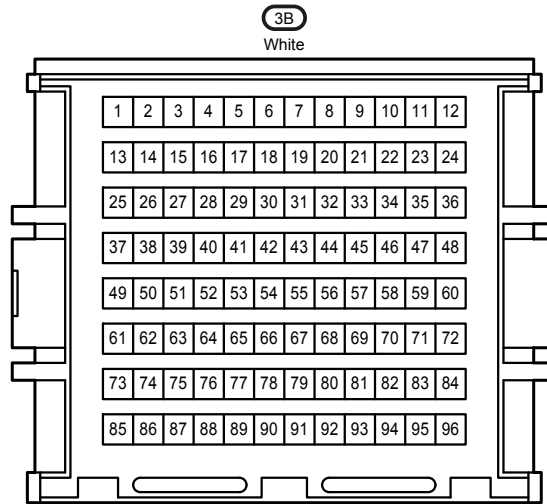
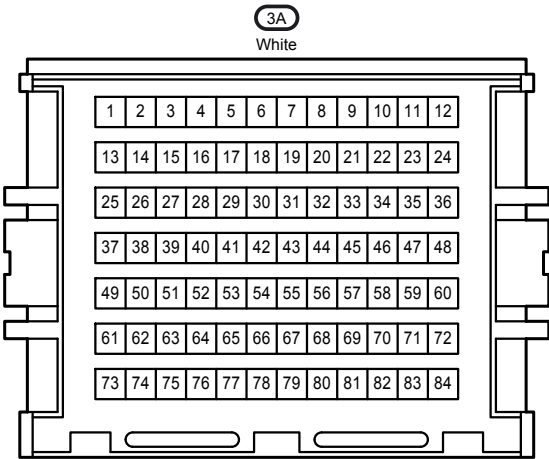
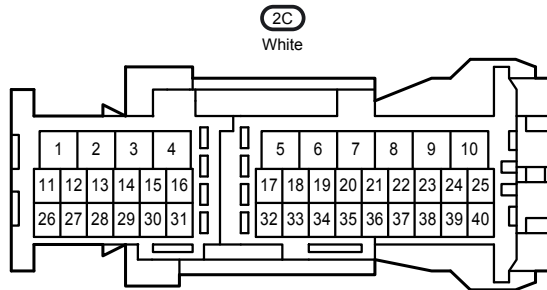
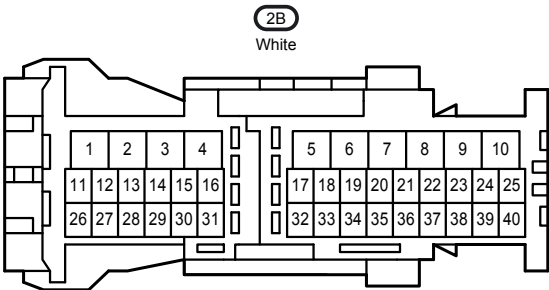
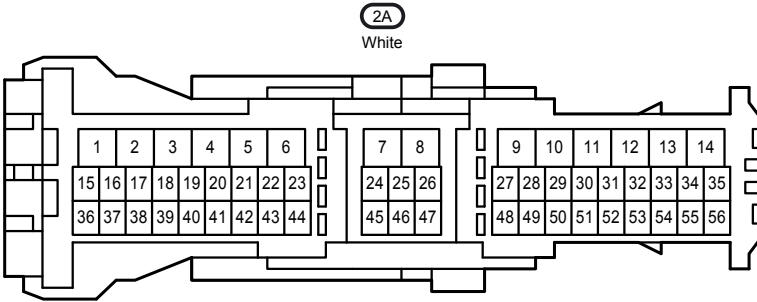
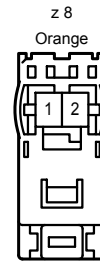
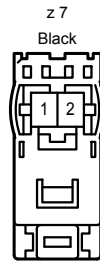
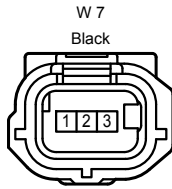
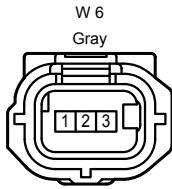

AL9  
Yellow

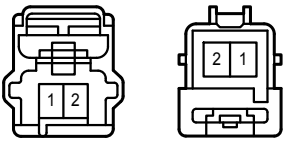

IM1  
White

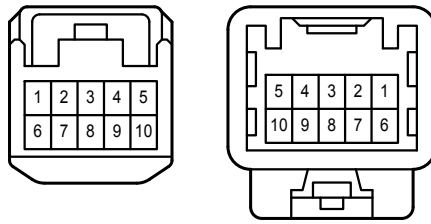

LH1  
Yellow

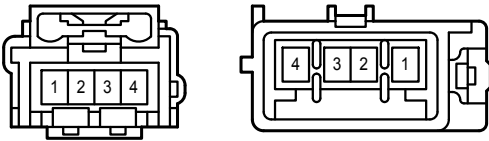

LI2  
White

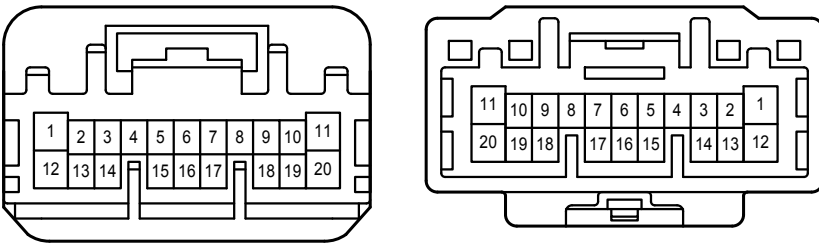

LL1  
White

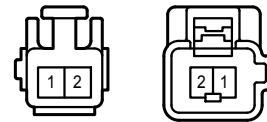

LS1  
White

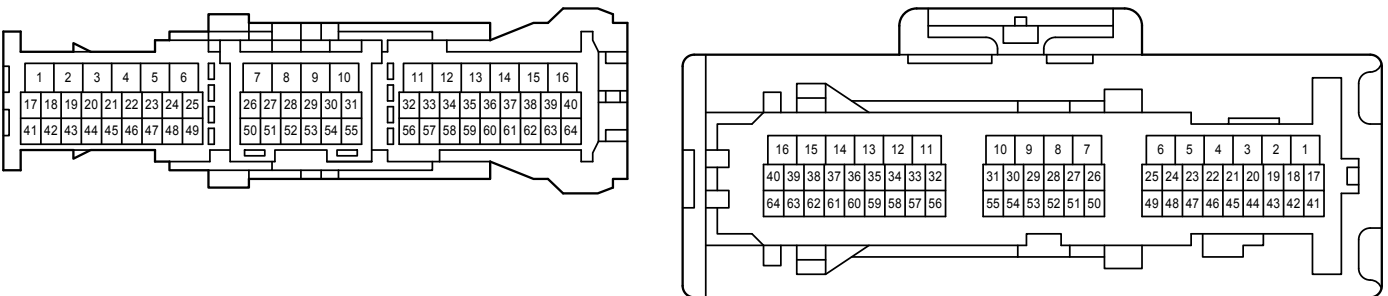

SW1  
Gray

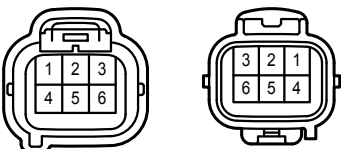

# Stop Light

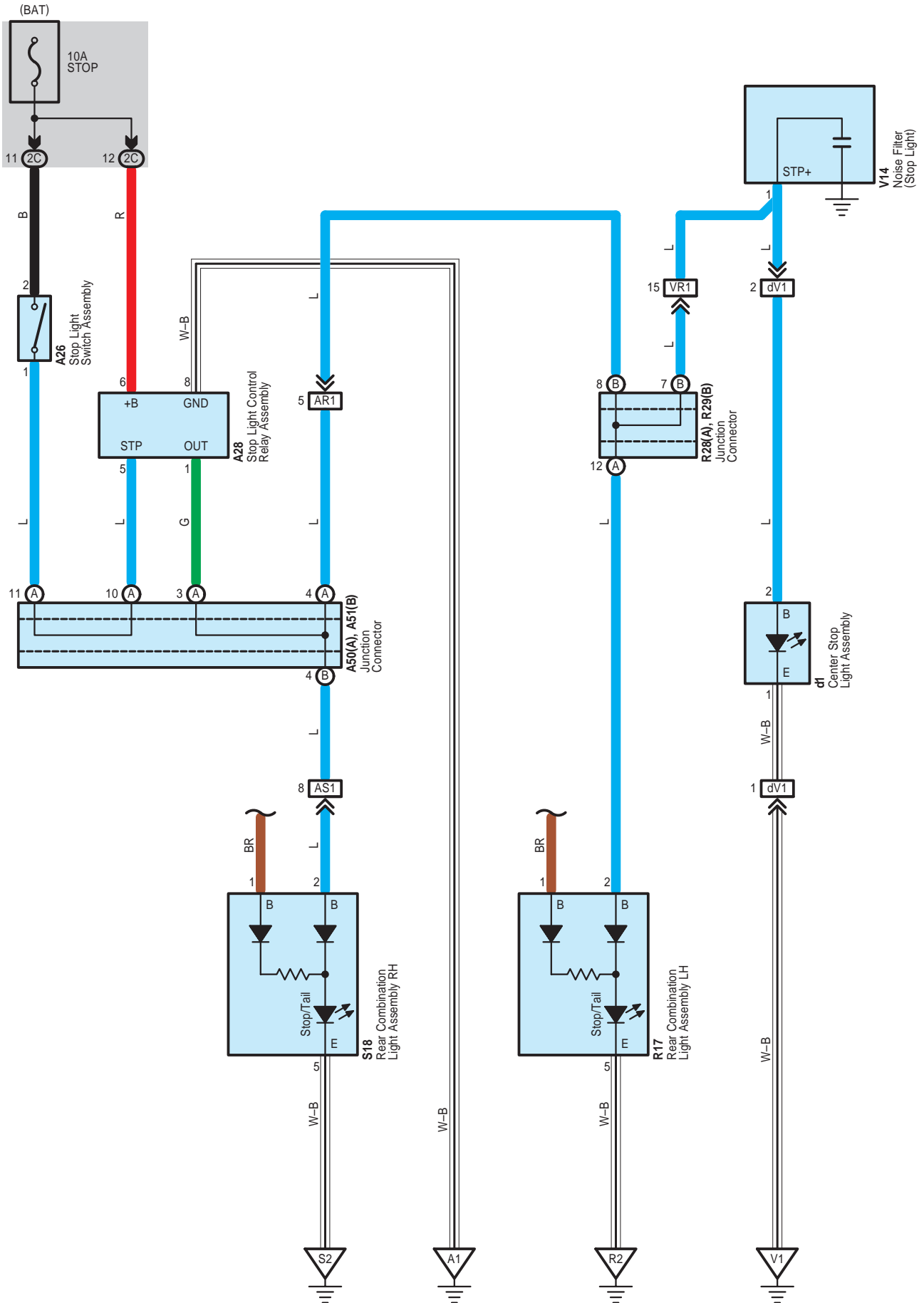

Stop Light

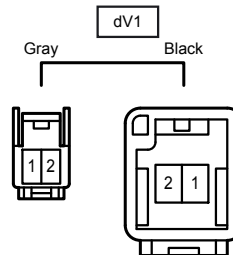
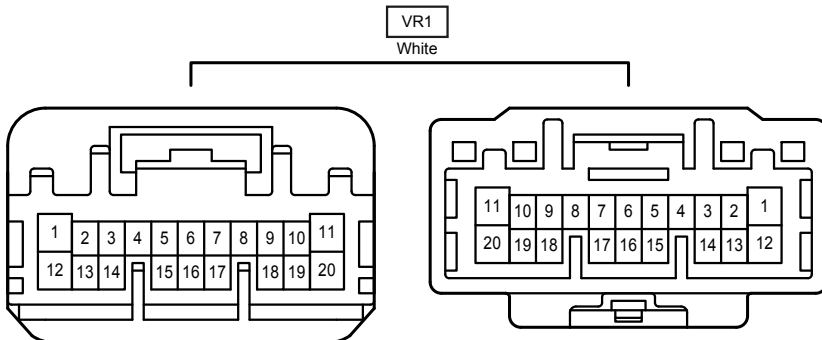
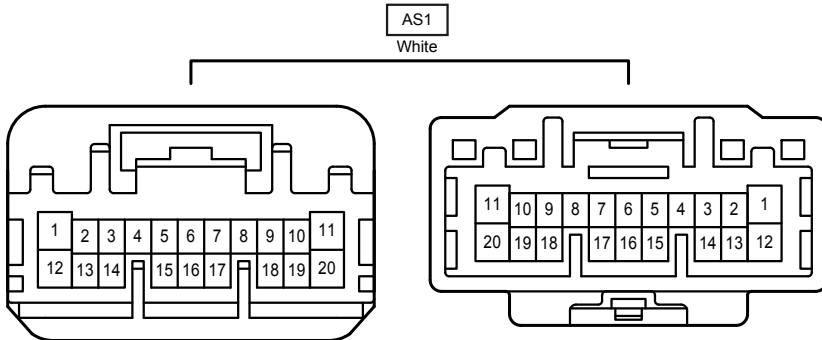
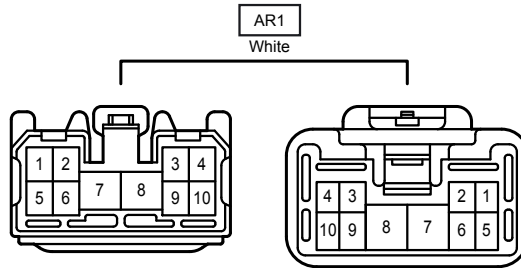
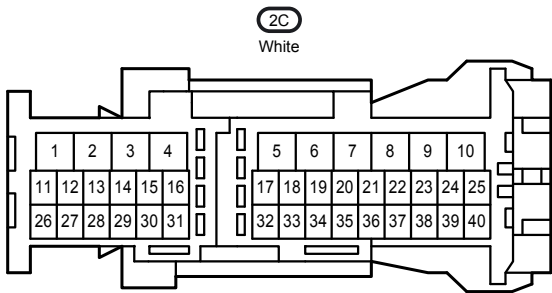
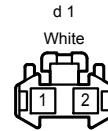
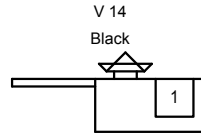
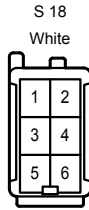
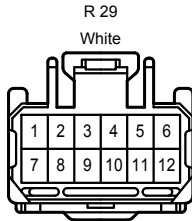
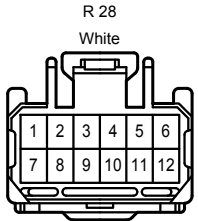
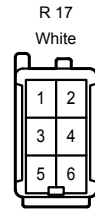
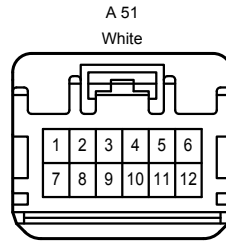
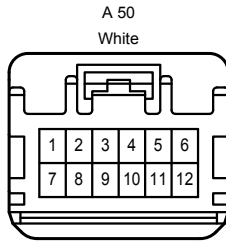
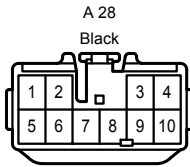
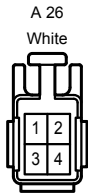



# Tire Pressure Warning System

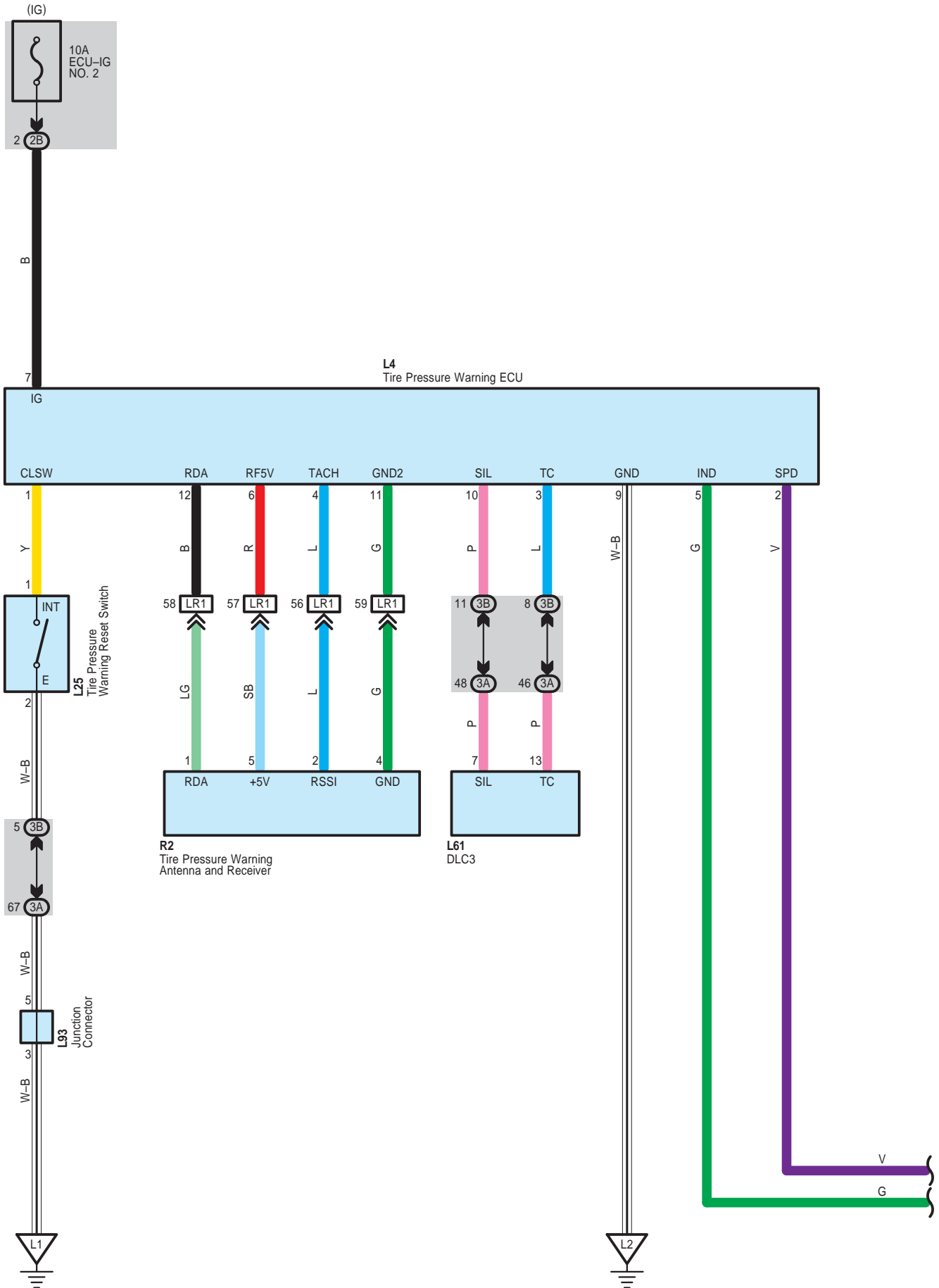

# Tire Pressure Warning System

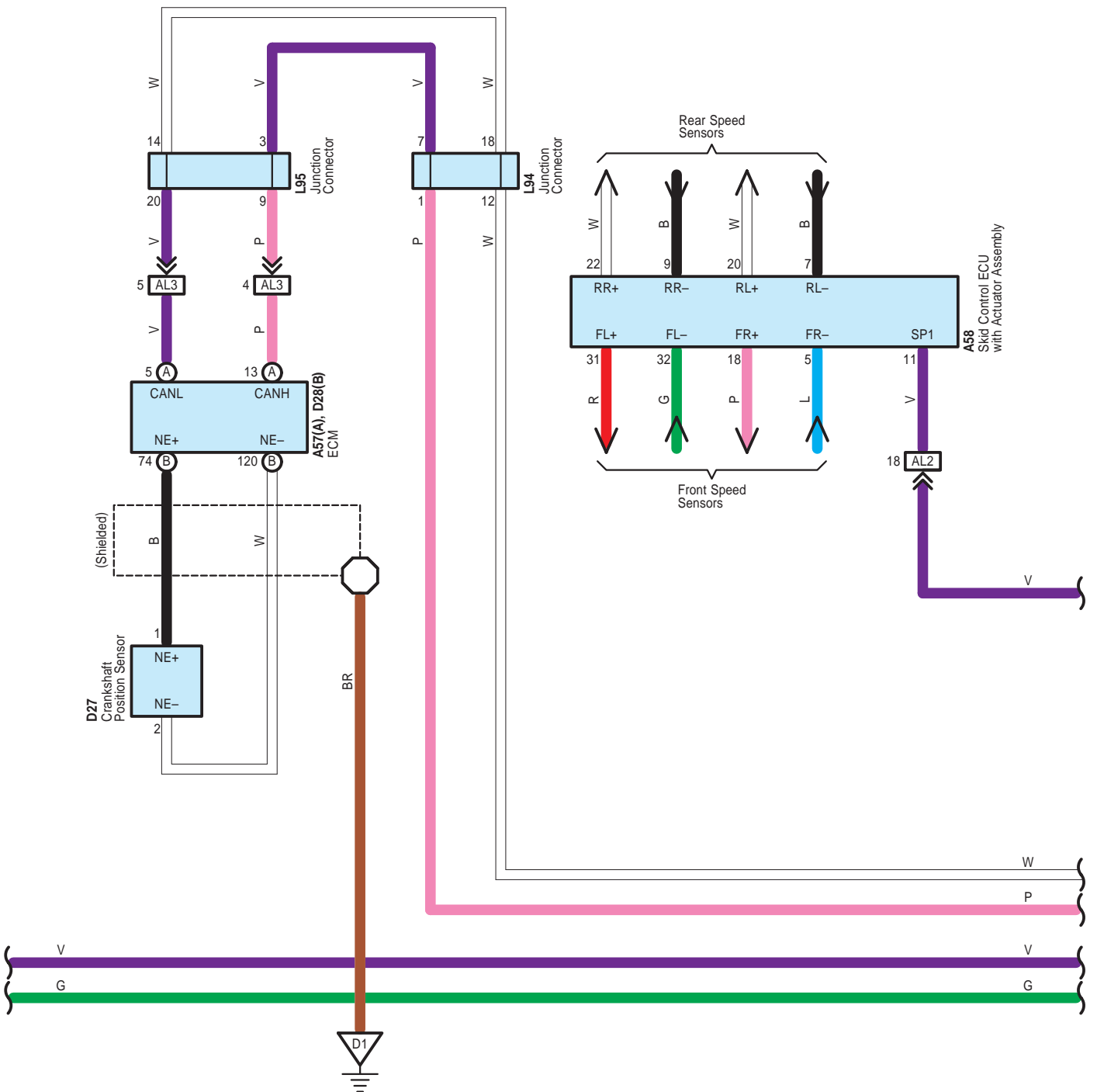

# Tire Pressure Warning System

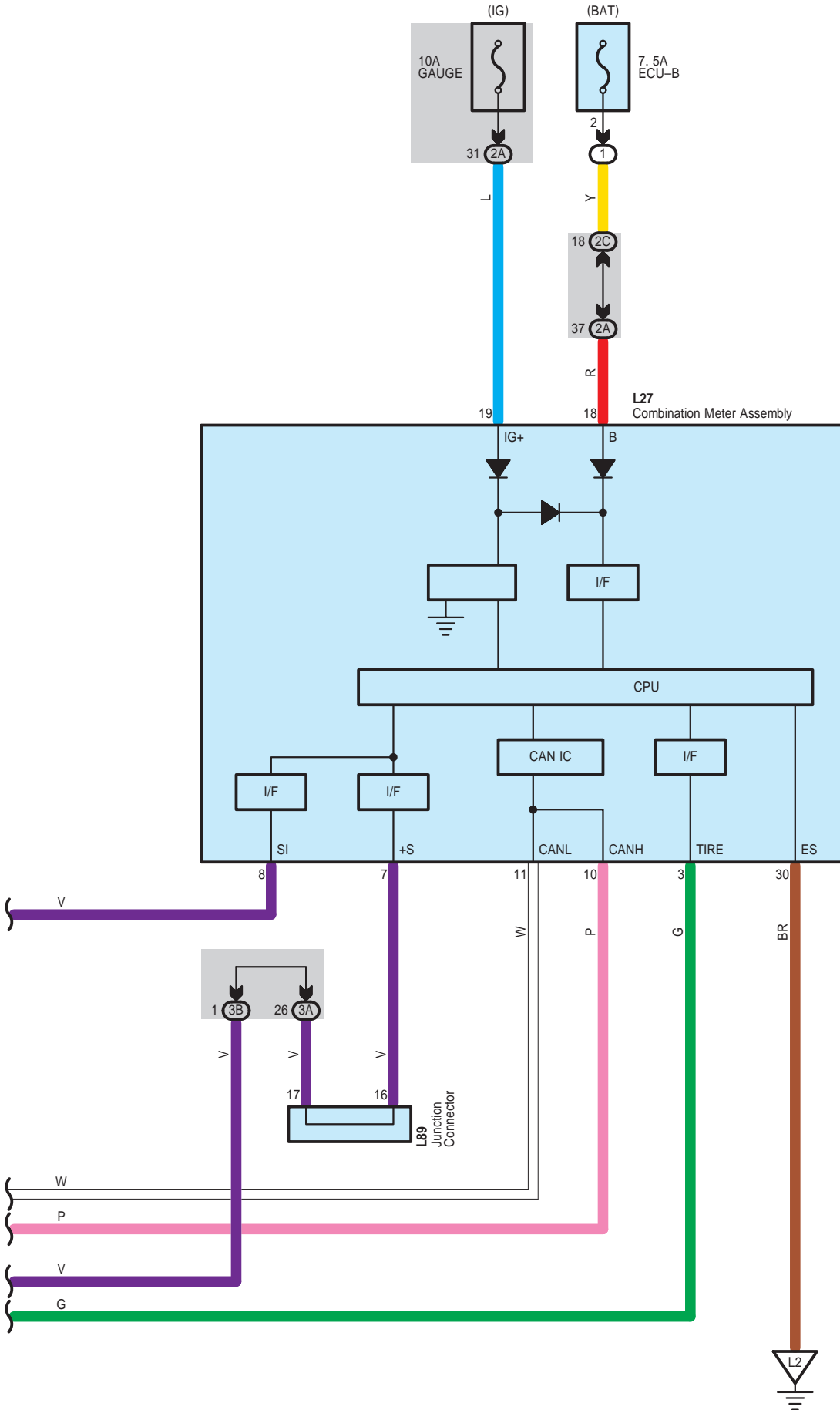

Tire Pressure Warning System

A 57  
Black

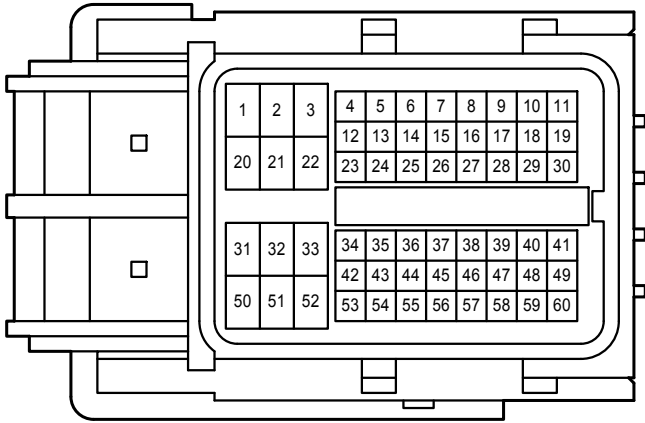

A 58  
Gray

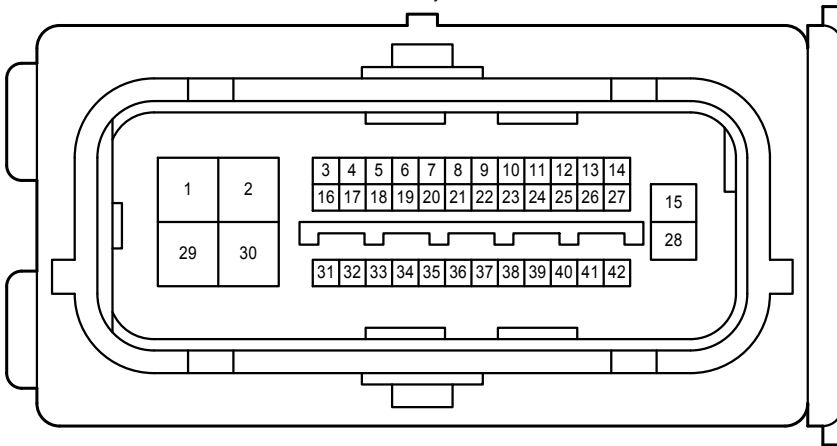

D 27  
Black

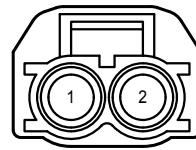

D 28  
Black

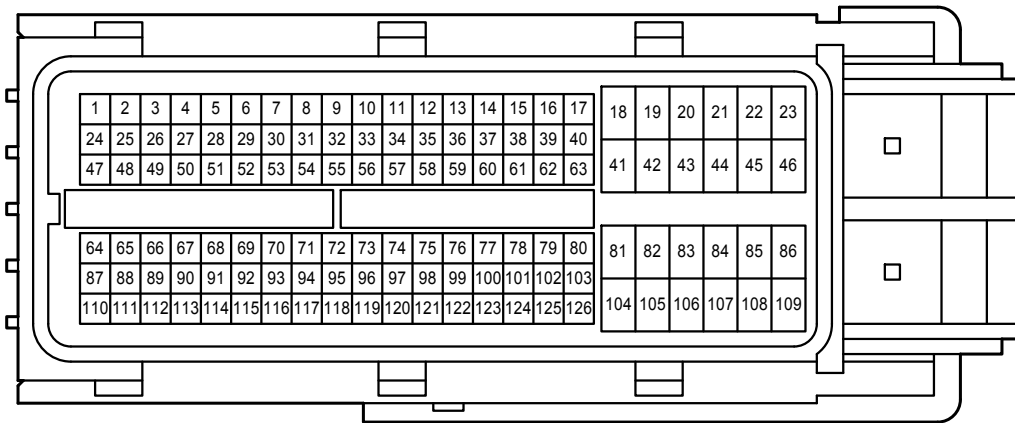

L 4  
Black

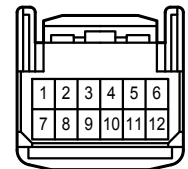

L 25  
White

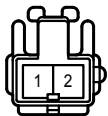

L 27  
White

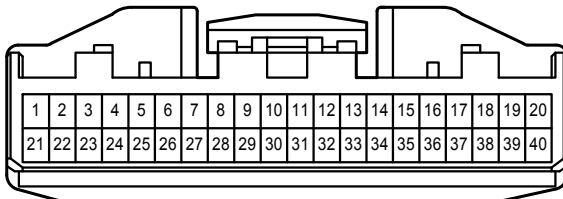

Tire Pressure Warning System

L 61

White

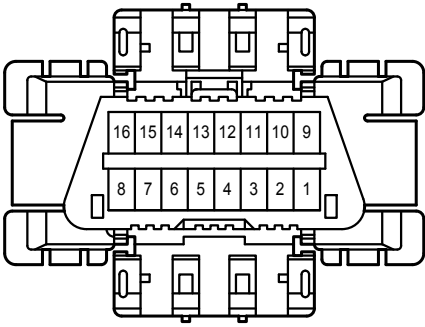

L 89

Black

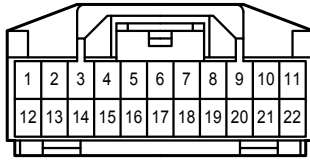

L 93

White

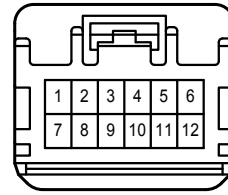

L 94

White

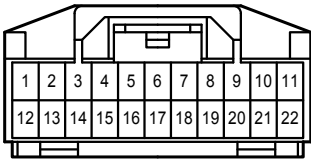

L 95

White

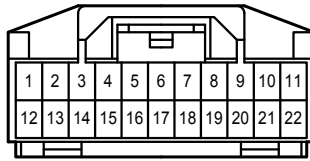

R 2

White

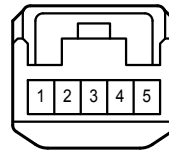

2A

White

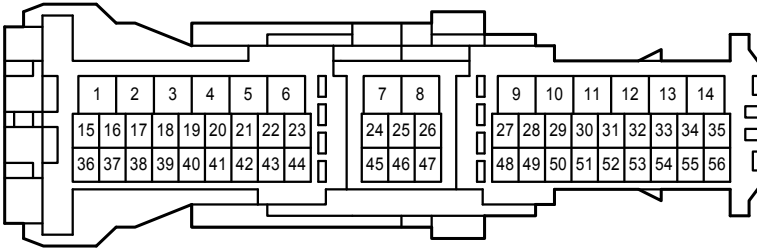

2B

White

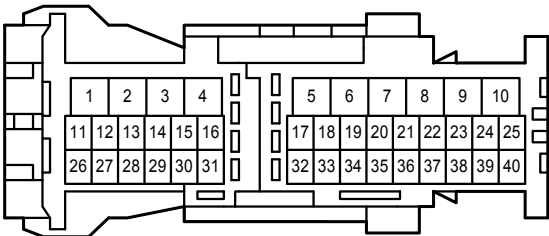

2C

White

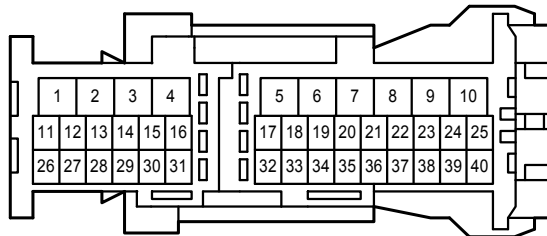

3A

White

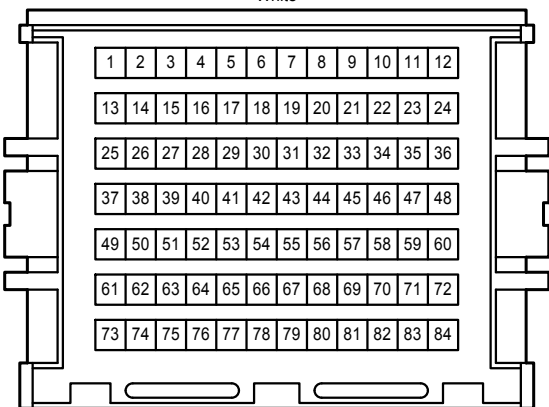

3B

White

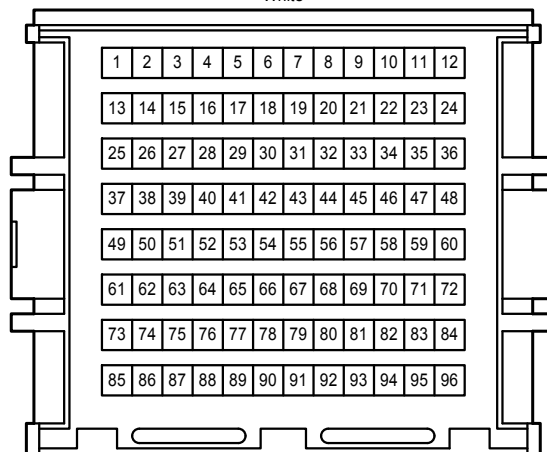

Tire Pressure Warning System

AL2  
Gray

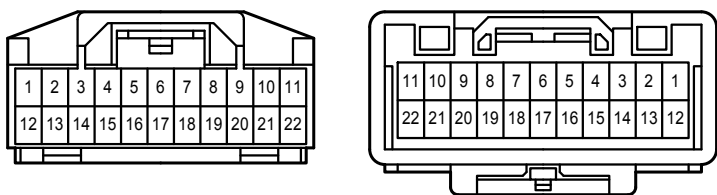

AL3  
White

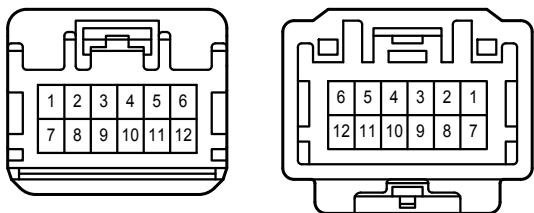

LR1  
White

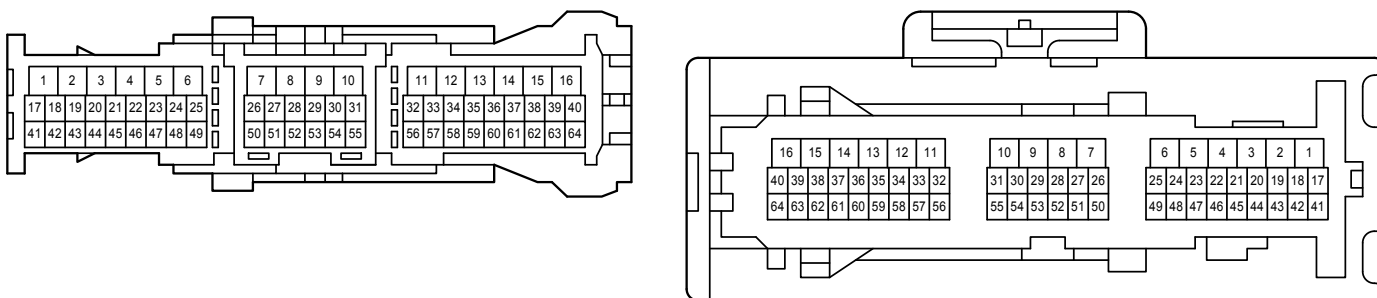

# Turn Signal and Hazard Warning Light

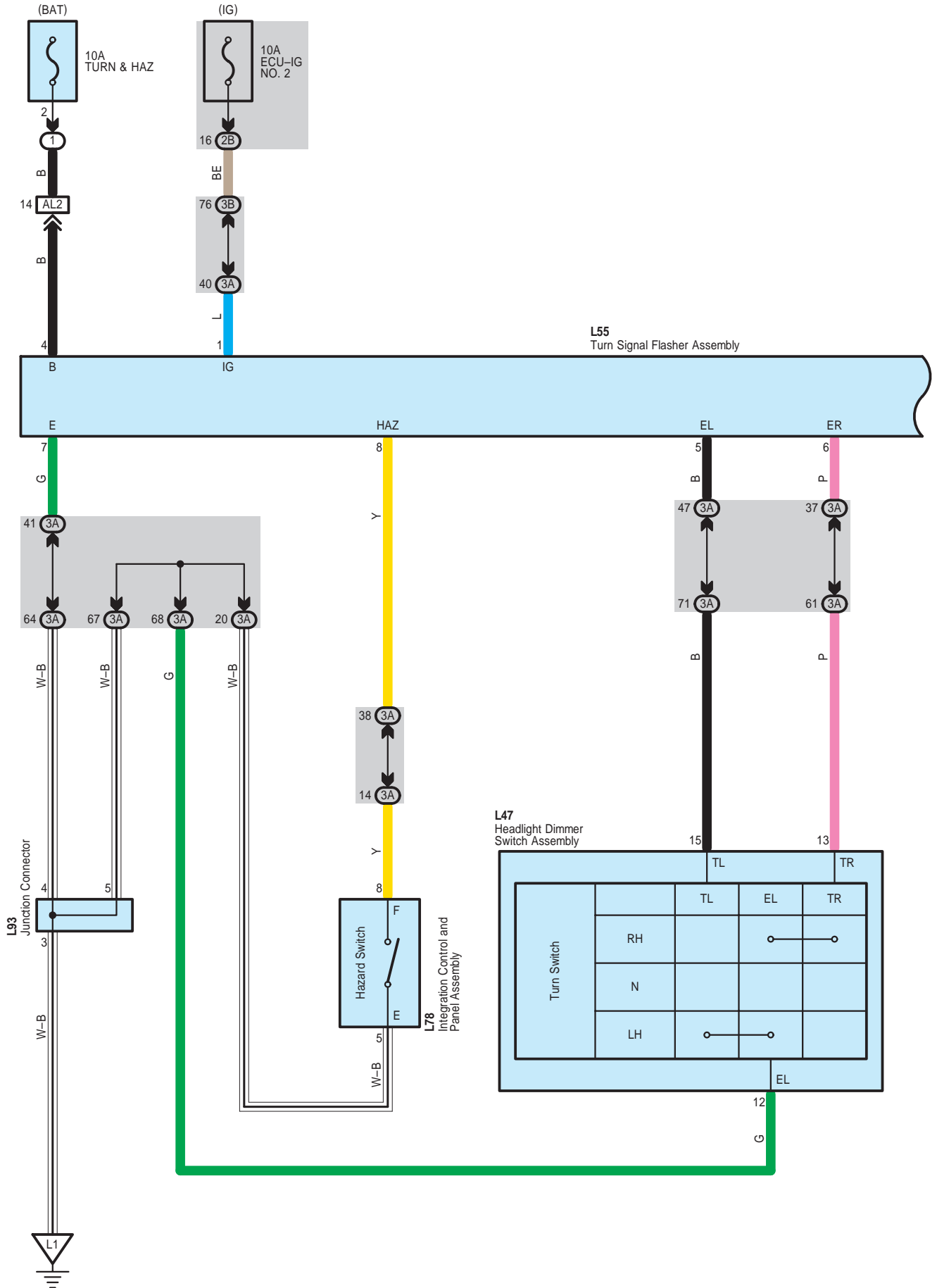

# Turn Signal and Hazard Warning Light

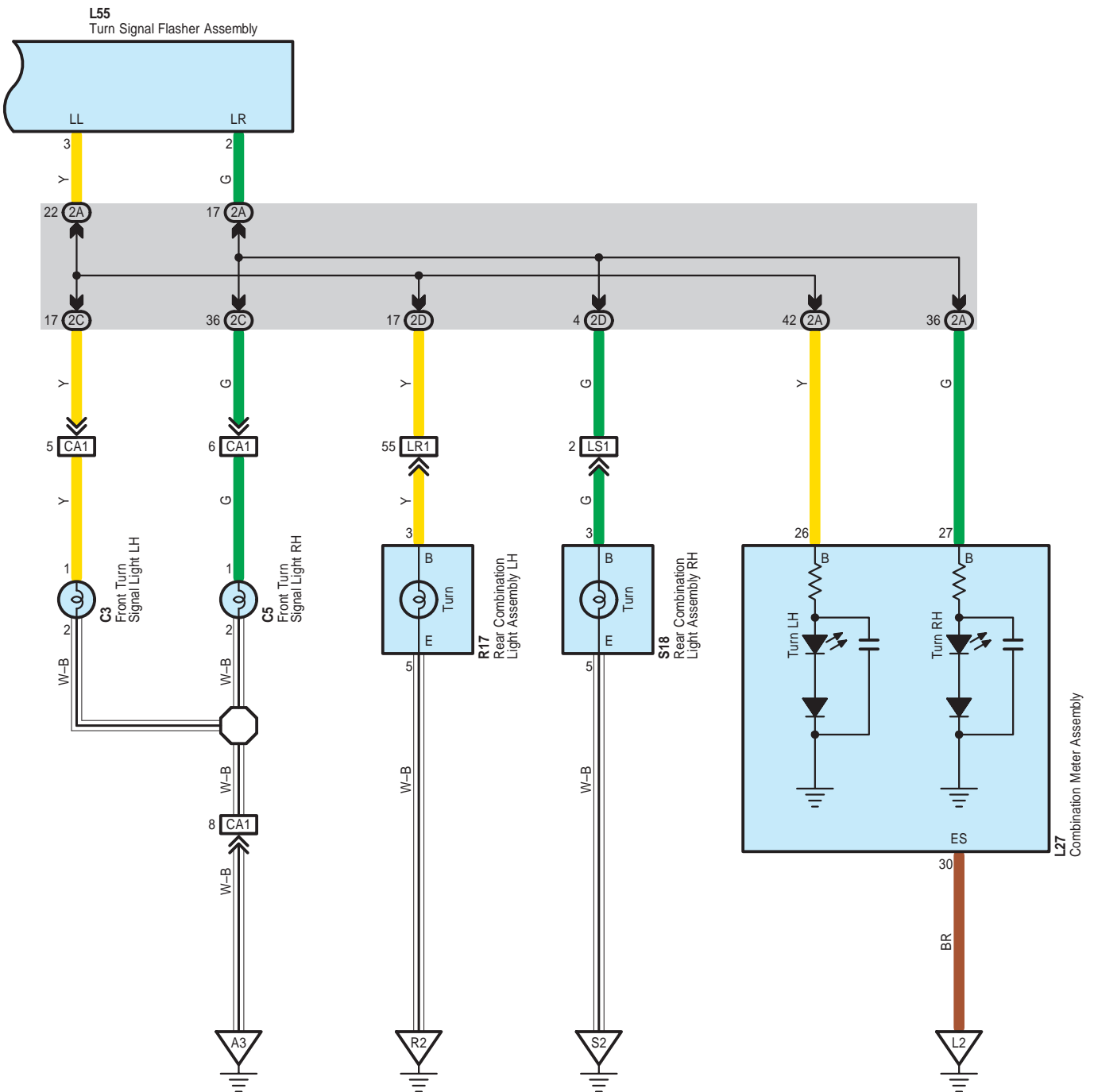



Turn Signal and Hazard Warning Light

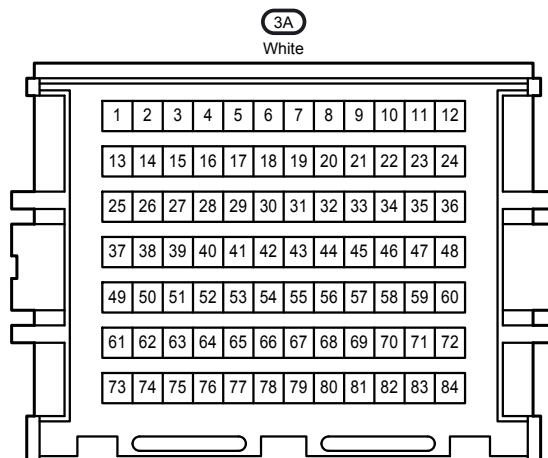
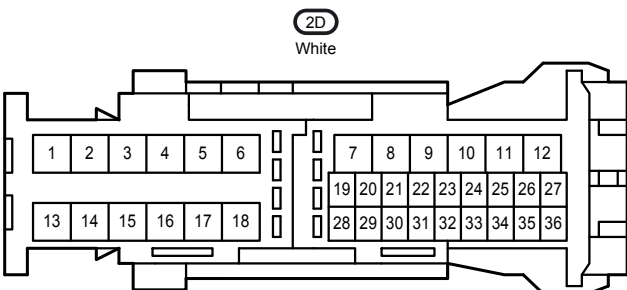
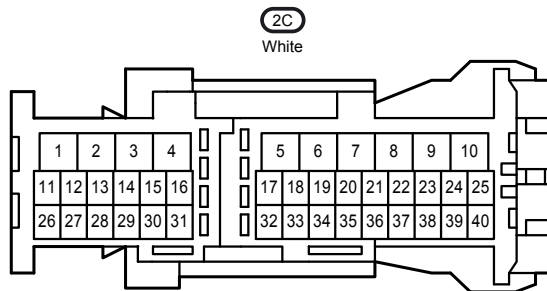
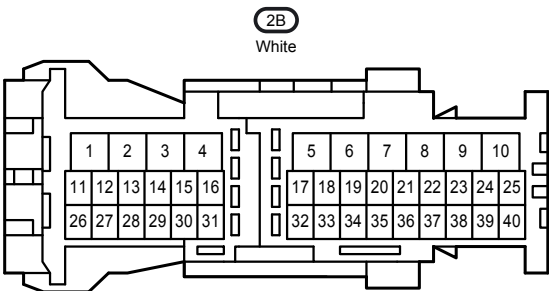
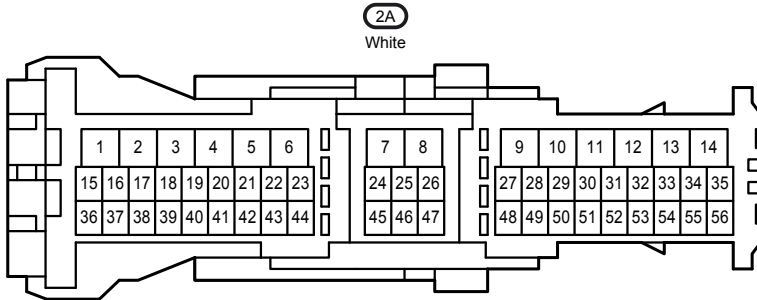
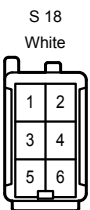
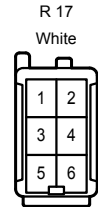
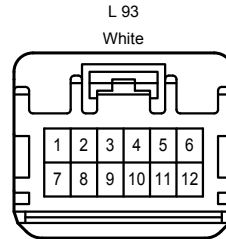
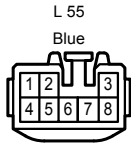
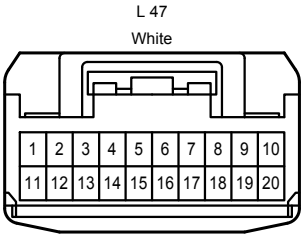
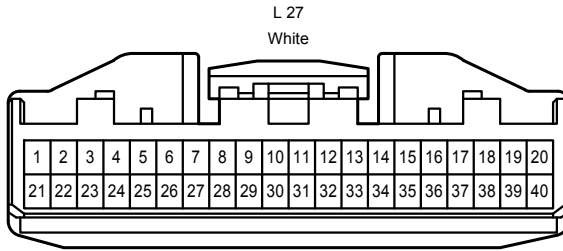
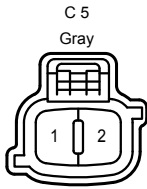
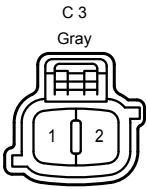

Turn Signal and Hazard Warning Light

3B  
White

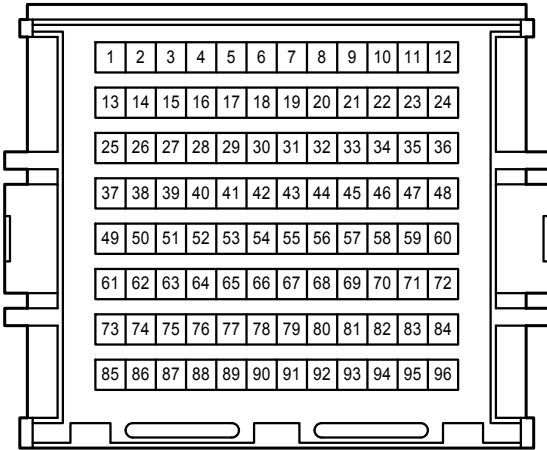

AL2  
Gray

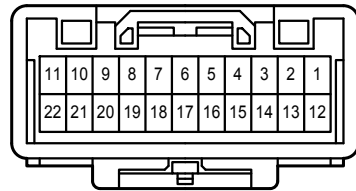
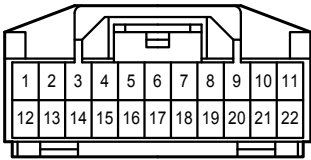

CA1  
Black

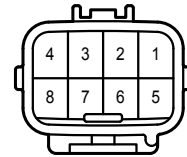
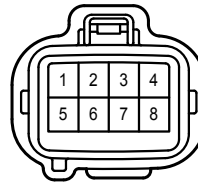

LR1  
White

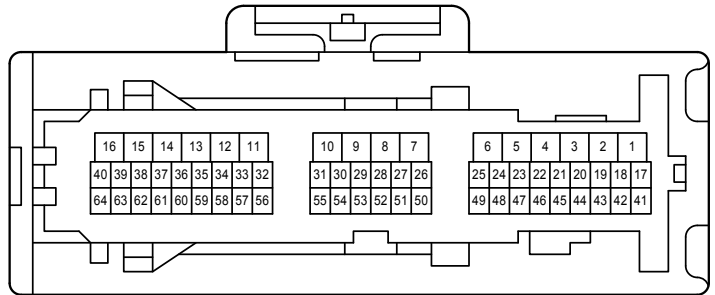
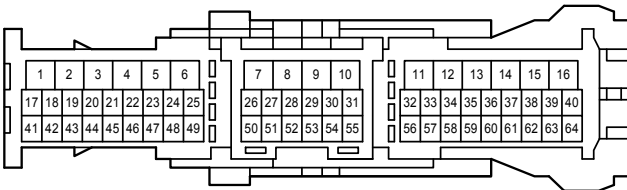

LS1  
White

