

Preparation

**Part Number: PT949-08231 (Dashcam)
PT949-48210 (Y-Harness)**

Legacy Part Number: PT949-08230 (Dashcam)

Dashcam Kit Contents

Item #	Quantity Req'd.	Description
1	1	Dashcam Main Unit
2	1	SD Card Holder
3	1	SD Card (16 GB)
4	1	Window Mounting Plate
5	1	Foam Tape
6	2	Cable Ties
7	1	Quick Start Guide

Y-Harness Kit Contents

Item #	Quantity Req'd.	Description
1	1	Mirror Patch Y-Harness
2	2	Foam Tape
3	4	Cable Ties

Additional Items Required For Installation

Item #	Quantity Req'd.	Description
1	1	PT949-08231 (Dashcam Unit)
2	1	PT949-48210 (Y-Harness)

Conflicts

N/A

Recommended Tools

Personal & Vehicle Protection	Notes
Seat Protection	
Dash Protection	
Temperature Gauge	
Special Tools	Notes
Pri23-0027 Install Aid	For Port Installations Only The legacy part number PT949-IAD0T also valid and can be used.
Installation Tools	Notes
Panel Tool	
Socket Wrench	With 10 mm Socket
Torque Wrench	With 10 mm Socket
Hooked Panel Tool	
Needle Nose Pliers	For Sun Visor Clip Removal
Special Chemicals	Notes
VDC Approved Cleaner	To Clean Windshield

General Applicability

All Models

Recommended Sequence of Application

Item #	Accessory
1	Dashcam (PT949-08231)
2	Y-Harness (PT949-48210)

*Mandatory

Vehicle Service Parts (may be required for reassembly)

Item #	Quantity Req'd.	Description
1	Up to 4 pcs	Roof Console YELLOW Clips if damage occurs during removal. P/N: 90467-09245
2		
3		
4		

Kit Service Parts (may be required in future)

Item #	Part Number	Description
1	PT949-08210-AA	Camera Unit + SD
2	PT949-60220-AB	SD Card 16GB Industrial
3	PT949-60220-AC	SD Card Holder Assembly
4	PT949-08210-AD	Window Plate with Tape

Legend

 **STOP:** Damage to the vehicle may occur. Do not proceed until process has been complied with.

 **OPERATOR SAFETY:** Use caution to avoid risk of injury.

 **CAUTION:** A process that must be carefully observed in order to reduce the risk of damage to the accessory/vehicle and to ensure a quality installation.

 **TOOLS & EQUIPMENT:** Used in Figures calls out the specific tools and equipment recommended for this process.

 **REVISION MARK:** This mark highlights a change in installation with respect to previous issue.

 **SAFETY TORQUE:** This mark indicates that torque is related to safety.

 **REGULATORY MARK:** This mark indicates the component is related to regulatory compliance

Care must be taken when installing this accessory to ensure damage does not occur to the vehicle. The installation of this accessory should follow approved guidelines to ensure a quality installation.

These guidelines can be found in the "Accessory Installation Practices" document.

This document covers such items as:-

- Vehicle Protection (use of covers and blankets, cleaning chemicals, etc.).
- Safety (eye protection, rechecking torque procedure, etc.).
- Vehicle Disassembly/Reassembly (panel removal, part storage, etc.).
- Electrical Component Disassembly/Reassembly (battery disconnection, connector removal, etc.).

Please see your Lexus dealer for a copy of this document.

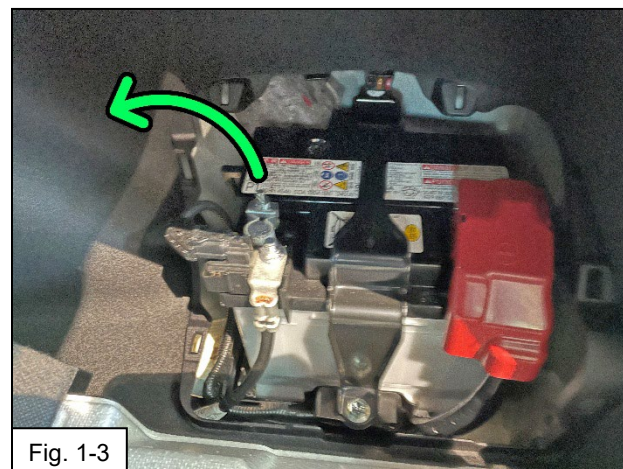
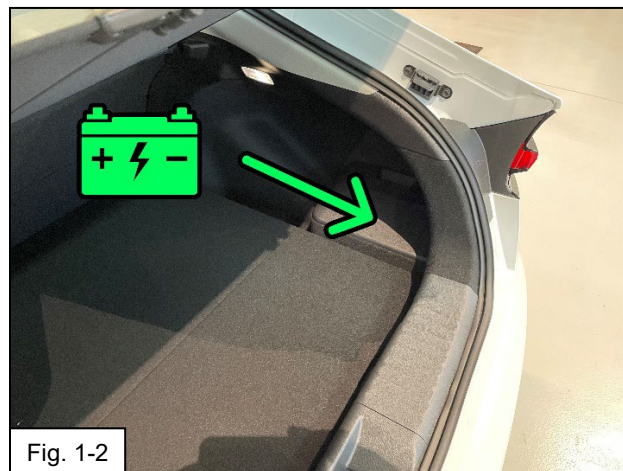
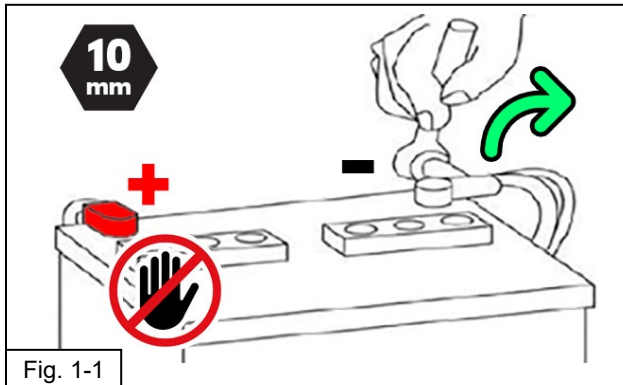

1. Disconnect Battery

- (a) Protect the fender / bumper before starting.
- (b) The engine components and coolant may be hot.
- (c) Remove the vehicle's 12V battery negative terminal (Fig. 1-1).

CAUTION: Do not touch the positive terminal with any tool during battery disconnection.

- NOTE: Temporarily Install DCC Cut Fuse (Short Pin) if applicable. (Validate location by following fuse box diagram in reverse side of relay cover).**

Battery Disconnection:

- (d) The 12V Battery is located in the trunk compartment on the passenger side. (Fig. 1-2).
- (e) Protect the Fender / Bumper paintwork.
- (f) Lift up the cargo floor panel and remove the battery cover panel.
- (g) Disconnect the Negative Cable by loosening the 10 mm nut shown by the arrow. It is not necessary to fully remove this nut. (Fig. 1-3)
- (h) Keep the Negative Cable away from the battery terminal to avoid accidentally reconnecting the 12V power if the cable falls back to its natural shape.

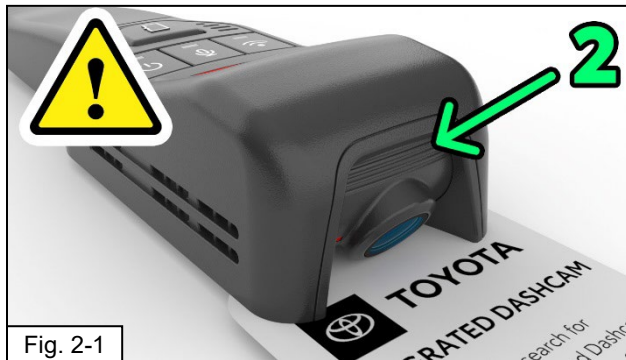



Fig. 2-1

2. Kit Preparation

- (a)  Check the Dashcam Kits for missing contents or damage.
- (b)  Confirm Camera Angle Position – 2 visible recessed lines should be seen below the lens with the camera held in the as-installed orientation. (Fig. 2-1, Note: Camera is upside down in the image)

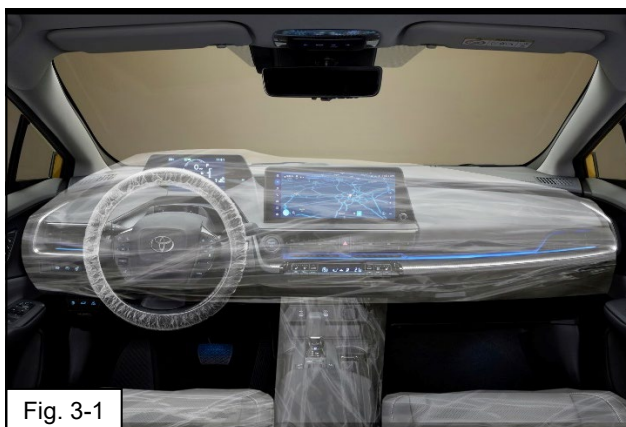
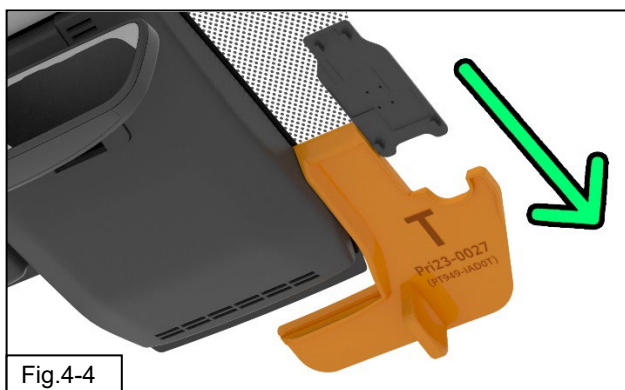
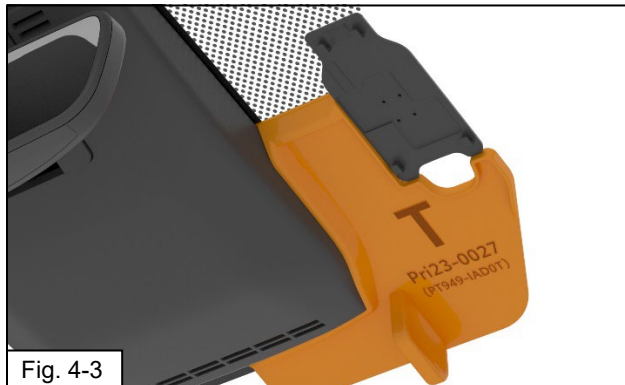
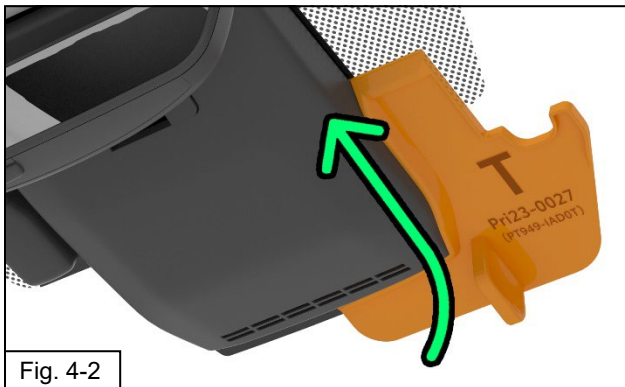

Fig. 3-1

3. Vehicle Protection



- (a) Apply Vehicle Protection to driver and passenger's seat, steering wheel, dashboard, and center console. (Fig. 3-1)



4. Install Windshield Base Plate



STOP: The front windshield must be at least 50°F (10°C).

- (a) On the passenger's side of the vehicle, using window cleaner and a lint free cloth, clean the windshield area next to the TSS cover and Rain Sensor.
- (b) For PPO Installations, please use 3D hard template "T" with the part number "Pri23-0027" (Legacy: PT949-IAD0T) (Fig. 4-1) and follow steps (d) through (f). 
- (c) For Dealer Installations or in the case that the 3D hard template is unavailable, please follow steps (g) through (i) 
- (d) Insert the 3D Template (Pri23-0027) between the TSS cover and the windshield glass, it should fit snugly against the TSS cover side walls, and the features of the template should allow it to stay in place hands free. If not, apply a small bit of tape for support to the lower edge. (Fig. 4-2)
- (e) Remove adhesive and stick mounting plate on windshield while aligning to the lower and right-side edges of the mounting plate. Press firmly to reduce visible air pockets. Note that the narrow end of the plate is towards the top of the windshield. (Fig. 4-3)
- (f) Remove the 3D hard template by gently pulling towards the base of the windshield (wiper cowl area) to slide it out from under the TSS cover. (Fig. 4-4)

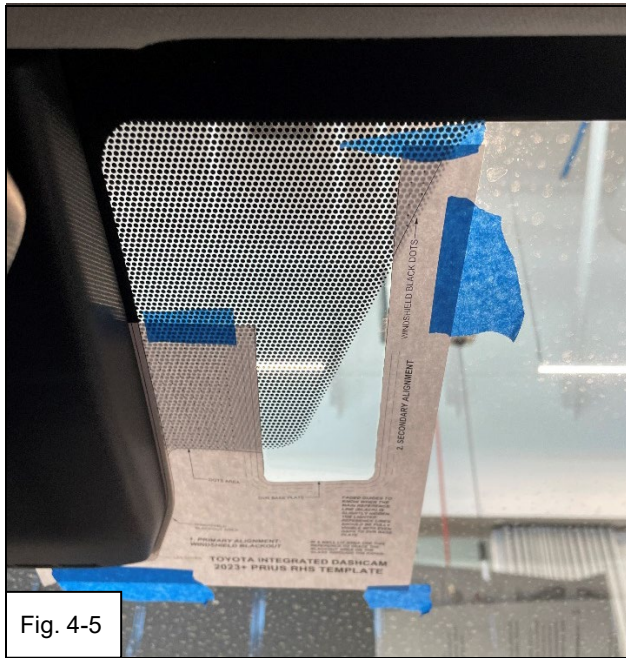

Fig. 4-5



Fig. 4-6

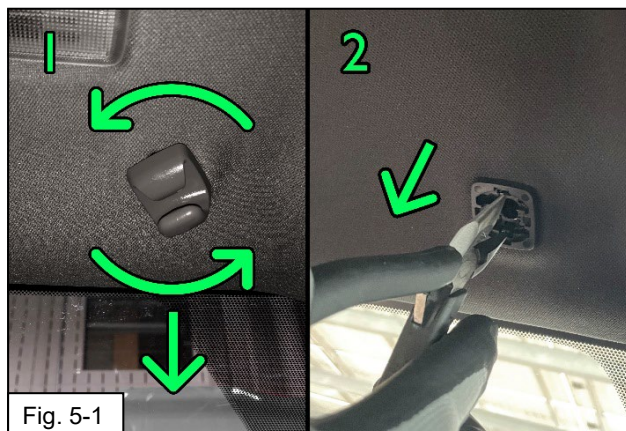

Fig. 5-1

For Dealer Installations / No 3D Hard Template Available:

- (g) Using scissors, cut the paper template as indicated. For PPO Installations, please use 3D hard template provided.
- (h) Referencing the TSS cover, align to the indicated line and affix the template to the windshield using tape. (Fig. 4-5)
- (i) Remove adhesive and stick mounting plate on windshield paying attention to the reference lines on template. Press firmly to reduce visible air pockets. Note that the narrow end of the plate is towards the top of the windshield. (Fig. 4-6)
- (j) Once the base plate is fitted, remove template in the direction towards the lower edge of the windshield and clean any tape residue from the glass.

All Installation types continue from here onwards.

5. Remove Visor Mount Clips and Base

- (a) Remove the Sun Visor Hooks on BOTH Driver and Passenger side of the Map Light Console, to allow for gentle pulling down of the headliner without damage.

⚠ Note: Both sides remove in the same direction, Passenger side is not mirrored.

- (1) Twist the Visor Hook Anti-Clockwise and pull down to release hook component. (Fig. 5-1)
-  (2) After removing the hook component, release the two tabs and pull out the base, needle nose pliers recommended.



Fig. 6-1

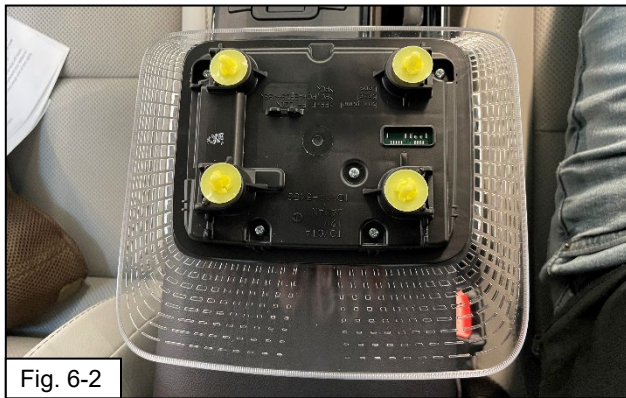





Fig. 6-2



Fig. 6-3

6. Remove Roof Map Light Console

Remove the roof console by first moving the mirror down for clearance, then by pulling down firmly on the forward edge (towards the front of the vehicle). Pull down firmly to release front 2 clips first then again pull down on the clear plastic lens to release the 2 clips at the rear edge. Do NOT pull down on the rear edge first as this may cause visible headliner damage. (Fig. 6-1)

-  (1) A plastic panel removal tool may be used to pull down on the console.
-  (2) CAUTION: Do **not** pry against the headliner or it will leave visible damage.
-  (3) CAUTION: Pull from rear of console (1) to avoid damage.
- (4) Note clips appearance in the image to better understand the removal process. (Fig. 6-2)
- (b) Once fully detached, disconnect the wire harness from the roof console and place the console in a safe place to avoid damage. (Fig. 6-3)
- (c) Inspect the console clips and replace if damaged (Yellow: 90467-09245)

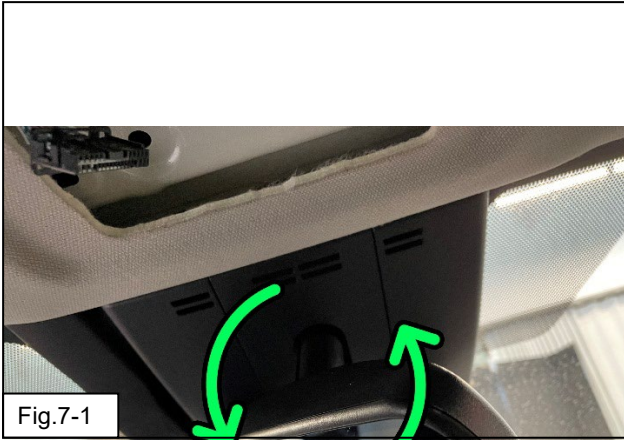

Fig. 7-1

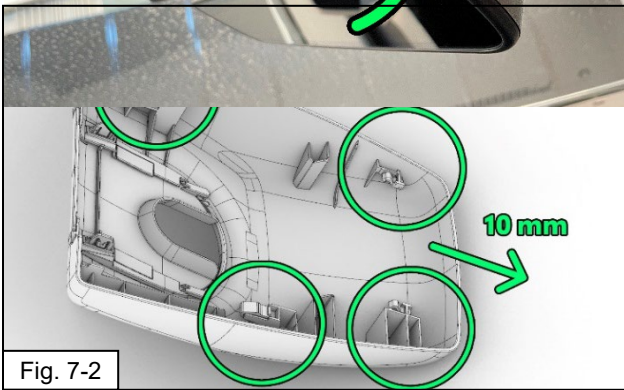

Fig. 7-2

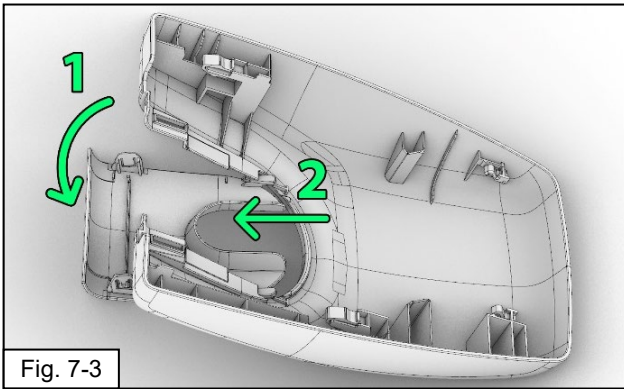

Fig. 7-3



Fig. 7-4

7. Remove the TSS Cover

(a) Start by rotating the mirror approximately 45 degrees to improve access to the sides of the TSS cover while retaining access directly above the mirror. (Fig. 7-1)

(b) Holding the TSS Cover firmly with both hands, move it downwards towards the windshield wiper cowl area by approximately 10 mm, without fully removing it. This is to get better access to remove the cover around the mirror (Fig. 7-2)

 (c) While supporting the main cover, pull down on the smaller inset cover around the mirror mount, using either your hooked panel removal tool or your fingertips, to detach the smaller cover from the main TSS cover. Take care not to scratch the headliner in the process.

(1) Pull down on the upper rearward edge of the cover plate (closest to the headliner) to disengage the clips. (Fig. 7-3), (Fig. 7-4)

(2) Alternatively, you can gently pull down on the headliner, reach through the Map Light Console opening and push down on the upper rearward edge of the cover plate

(3) Slide the smaller cover up and to the rear of the vehicle to disengage the lower hooks.

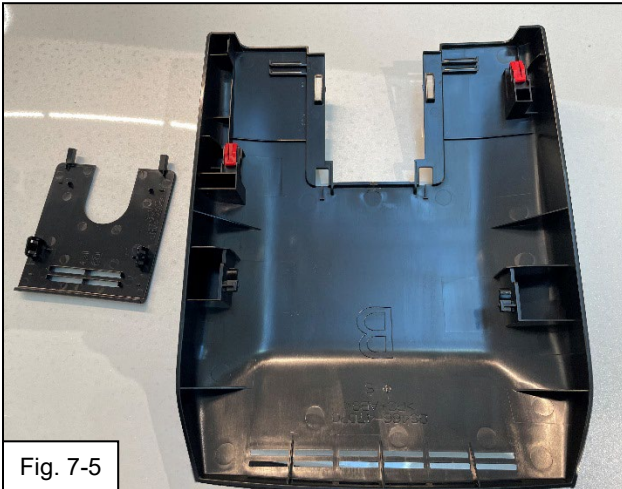

Fig. 7-5

- (d) Remove the TSS main cover by sliding the cover down (Fig. 7-5, shown from the back side for clarity) from the TSS cover base in the direction of the bottom of the windshield / towards the wiper cowl area. Both covers should now be fully removed. (Fig. 7-5)

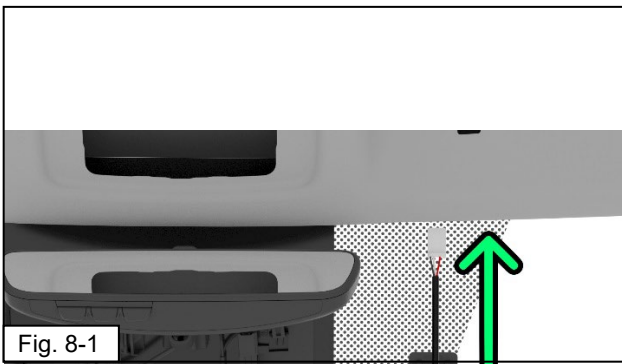

Fig. 8-1

8. Route Dashcam Harness through the Headliner

- (a) From the Passenger side of the vehicle, feed the Dashcam's pigtail harness up into the headliner, directly above the Dashcam mounting plate fixed to the windshield. Take care not to crease the headliner in the process. (Fig. 8-1)

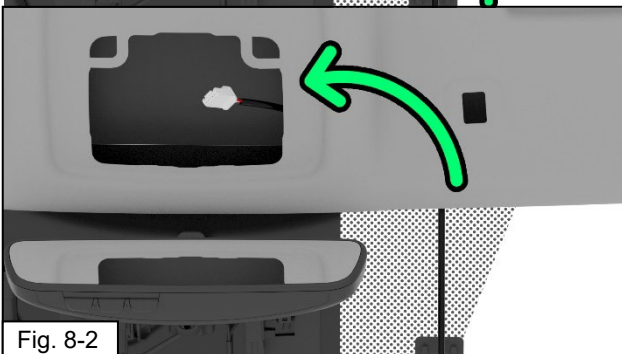

Fig. 8-2

- (b) Route the Dashcam pigtail through the headliner to the map light console area. (Fig. 8-2)



Fig. 8-3

- (c) Pull the majority of the wire length through to the console area so that the camera is ready to mount on to the window plate. (Fig. 8-3)

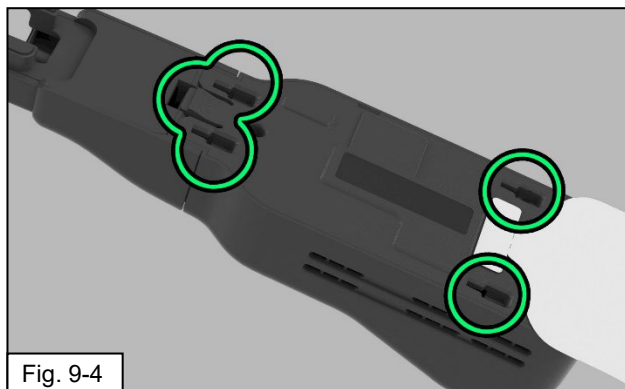
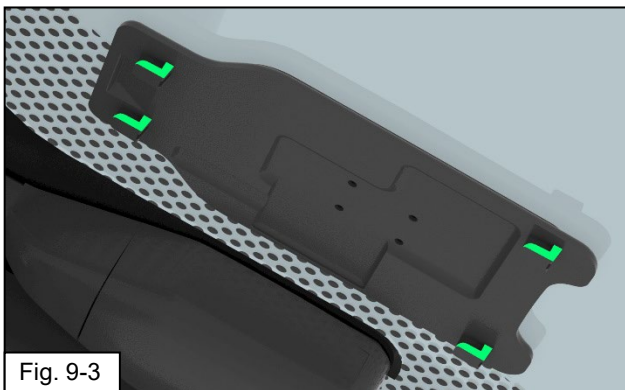

9. Fitting the Dashcam to Base Plate

NOTE: The Hang Tag that is attached to the Dashcam is **only to be removed by the end user**. As the camera turns on with ignition, the hang tag is intended to block recording while the vehicle is being processed through areas which may be confidential / contain unreleased vehicles.

Do NOT remove the hang tag, please handle it with care to prevent accidental removal. (Fig. 9-1)

IMPORTANT: Remove the **Semi-Transparent Blue Film** protective cover from the camera lens before fitting the camera to the vehicle. Handle the camera with care after removing. Ensure the film cover is not left behind in the vehicle and is properly discarded. (Fig. 9-2)

NOTE: Observe the shape of the T-hook features for the Dashcam to lock on to. The hooks face upwards towards the headliner. (Fig. 9-3)

The Dashcam is affixed to the window by sliding on to these 4 T-hooks and allowing the clip to engage. (Fig. 9-4)

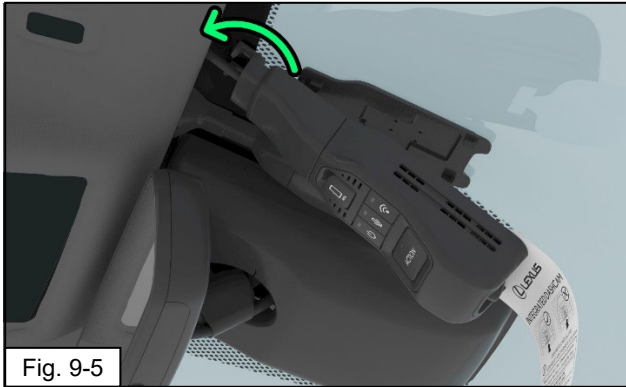

(a) Hook the Dashcam wire extension cover hooks into the leading edge of the headliner. (Fig. 9-5)



(b) Swing the Dashcam unit up towards the base plate. Check for alignment of the 4 T-hooks. (Fig. 9-6)



(c) Push the dashcam unit in towards the windshield to ensure all 4 T-hooks are in the correct starting point. All sides should have a consistent gap to the glass. (Fig. 9-7)



(d) Slide the Dashcam down towards the T-hooks and engage the clip that secures it. Adjust the telescopic wire harness cover as required to sit correctly, and confirm the hooks are tucked inside the leading edge of the headliner. (Fig. 9-8)



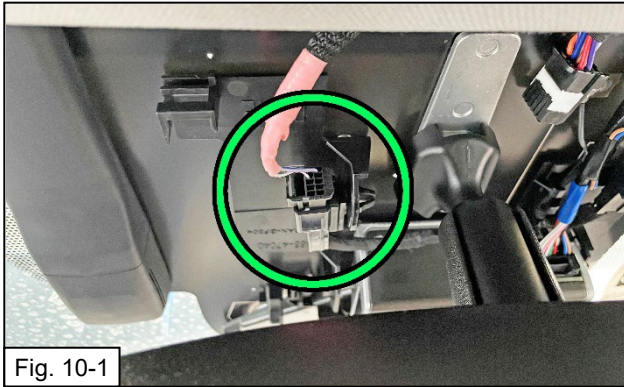

Fig. 10-1

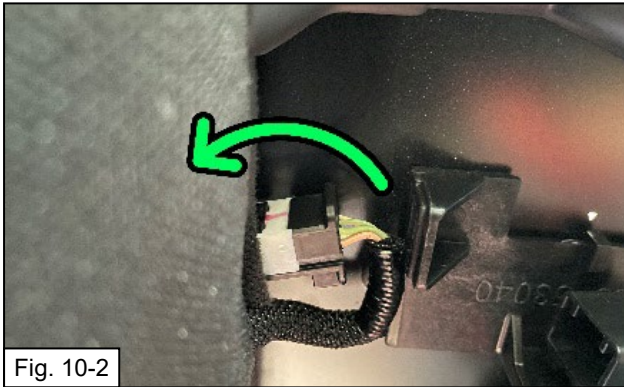

Fig. 10-2

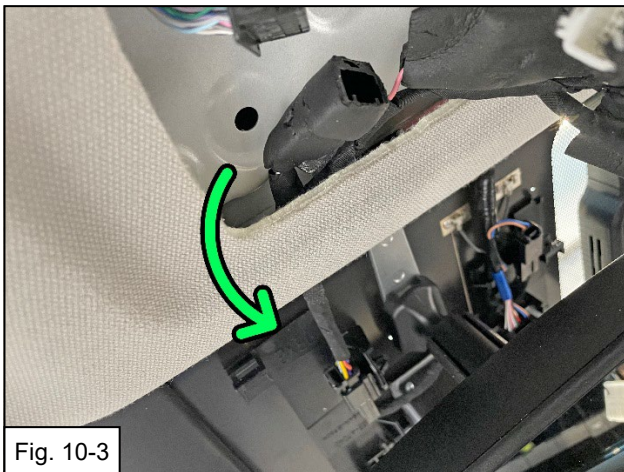

Fig. 10-3

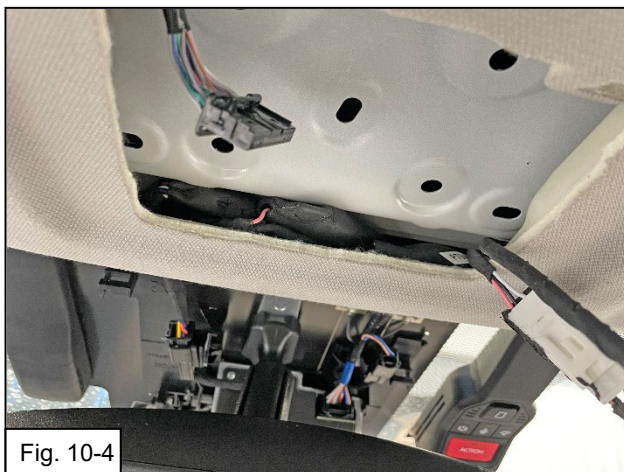

Fig. 10-4

10. Install the Y-Harness

(a) Disconnect the mirror power harness in on the release tab. The mirror harness is the 10-pin connector, on the Driver side of the mirror base. (Fig. 10-1)

(b) Install the Y-harness between the mirror and the vehicle mirror wire harness connector.

(1) Gently pull the vehicle's Power Mirror connector back inside the Map Light Console Area (Fig. 10-2)

(2) Insert the male mirror connector into the Y-Harness black female connector.

 (3) Apply the supplied Foam Tape to insulate the connector from rattles.

(4) Gently feed the black Y-Harness male connector back to the TSS area and insert into the female mirror connector affixed to the mirror base. (Fig. 10-3)

(5) Pull the remaining slack harness back into the headliner / map light console area as per the image. Arrange the fuse holders towards the front edge of the map light opening. (Fig. 10-4)

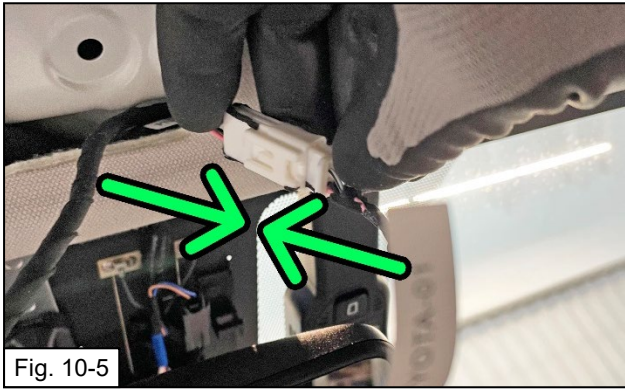

- (c) Connect the Dashcam pigtail harness to the newly fitted Y-harness that was fitted in step 7. (Fig. 10-5)



- (d) Apply the supplied Foam Tape to insulate the connectors from rattles.  (Fig. 10-6)



11. Reinstall the TSS Cover



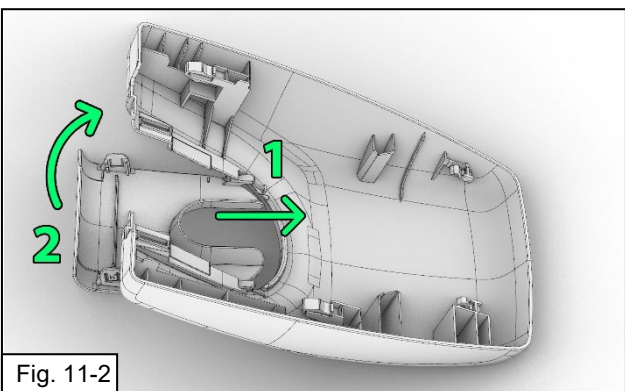

- (a) Reinstall the TSS cover by pushing up on the cover along the windshield in the direction towards the headliner to engage the mounting clips into the cover base. (Fig. 11-1)

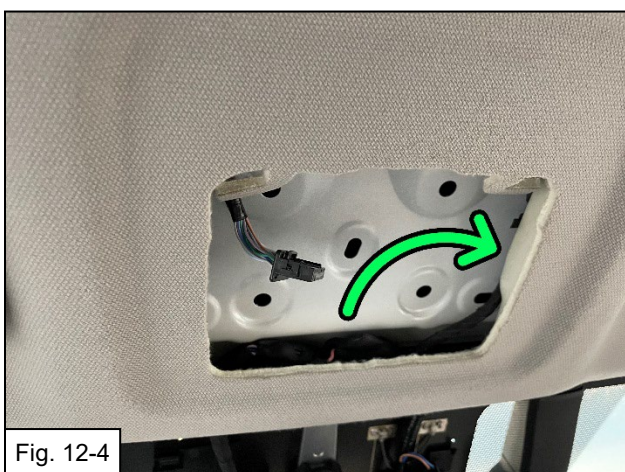
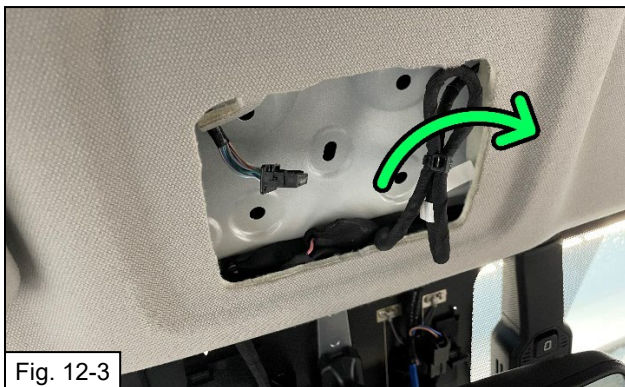
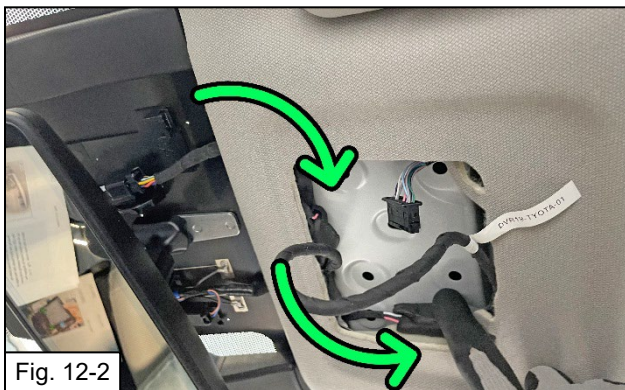

- (b) Reinstall the mirror cover plate by hooking the front hooks into the edge of the TSS main cover opening and push up on the mirror cover to engage the clips to the main cover. (Fig. 11-2)



12.Route / Bundle Wire Harness

- (a) Before proceeding with securing the harness, confirm that both connector pairs and fuse holders have been protected with the provided foam tape. Use the provided foam tape to minimize any potential rattle concerns. (Fig. 12-1)

- (b) Secure the Y-harness and fuse holders against the harness at the front edge and right side of the map light / sunglasses pocket opening. Snip excess Cable Tie length. (Fig. 12-2)
- (c) Secure the Dashcam Pigtail and Y-harness bundle to the right side of the console opening. Tuck it behind the plastic structure on the right of the opening. Arrange this in a way that does not obstruct the console being reinstalled. (Fig. 12-3, 12-4)
- (d) Ensure that the connections for the console is still free to be connected and that the bundled harnesses are not obstructing the console map light connector. (Fig. 12-4)
- (e) **Note: Take care not to cause bulging in the headliner. Some adjustments to the bundle may be required to avoid bulging the headliner.**

- (f) **Note: Do not block access to the clip holes in the body structure or the roof console may not fit properly.**

- (g) After securing, be sure to snip off extra cable-tie length to prevent any rattles or squeaks from the loose end of the cable tie strap.

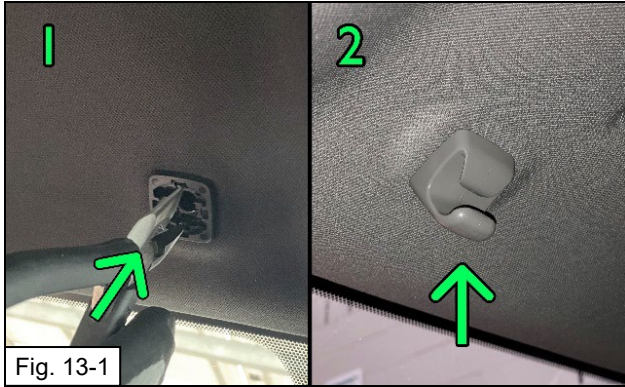

Fig. 13-1

13. Reinstall Sun Visor Clips

- (a) Insert the clip bases on both sides of the map light console, they should snap securely into place. (Fig. 13-1 L)
- (b) Insert the visor clips by placing them in the correct orientation and pushing them directly up into the bases. (Fig. 13-1 R)



Fig. 14-1

14. Reinstall Overhead Console

- (a) Re-connect harness for the overhead console, test map lights and sunroof control if equipped. (Fig. 14-1)
- (b) Check all console clips are in good condition and are present on the console. If any are still installed in the roof of the vehicle and have separated from the console, a panel tool with a forked end can be used to pry them out, then reinstall in the console. (Fig. 14-1)
- (c) Reinstall the console by carefully aligning the clips towards the front of the opening and observe the marks in headliner for alignment references. Carefully push in to place to lock, starting at the front and then the rear. Press firmly against the black plastic as the clips are behind this part, to protect the clear lens. Check all corners for gaps. If needed, reposition harnesses and try again. (Fig. 14-2)



Fig. 14-2

- (d)  **Note: Be careful aligning the clips to holes to avoid damage.**

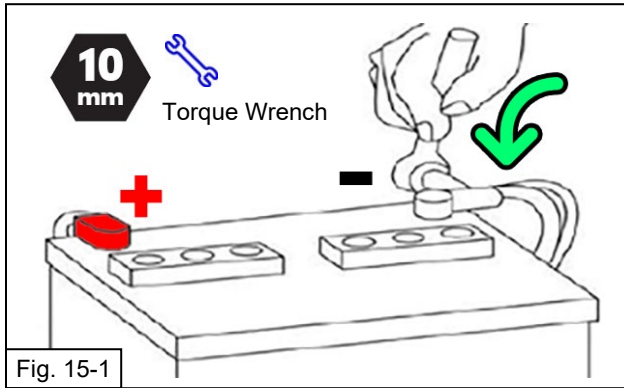

15. Reconnect Vehicle Battery

(a) Reconnect the Negative Battery Cable and replace cover trim if necessary.



(b) Torque to 5.4 N•m (48 in•lbf)



(c) **CAUTION:** Do not touch the positive terminal with any tool.

16. **NOTE:** Remove DCC Cut Fuse (Short Pin) if applicable. (Validate location by following fuse box diagram in reverse side of relay cover).



NOTE: Re-install the battery cover (Fig. 16-1) and floor liner back to their original position (Fig. 16-1).

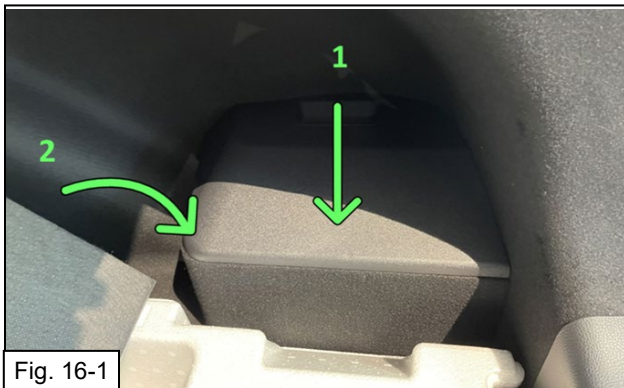

17. Owner's Manual



Place the Owner's Manual ("Quick Start Guide") in the glove box with the other vehicle owner's manuals.

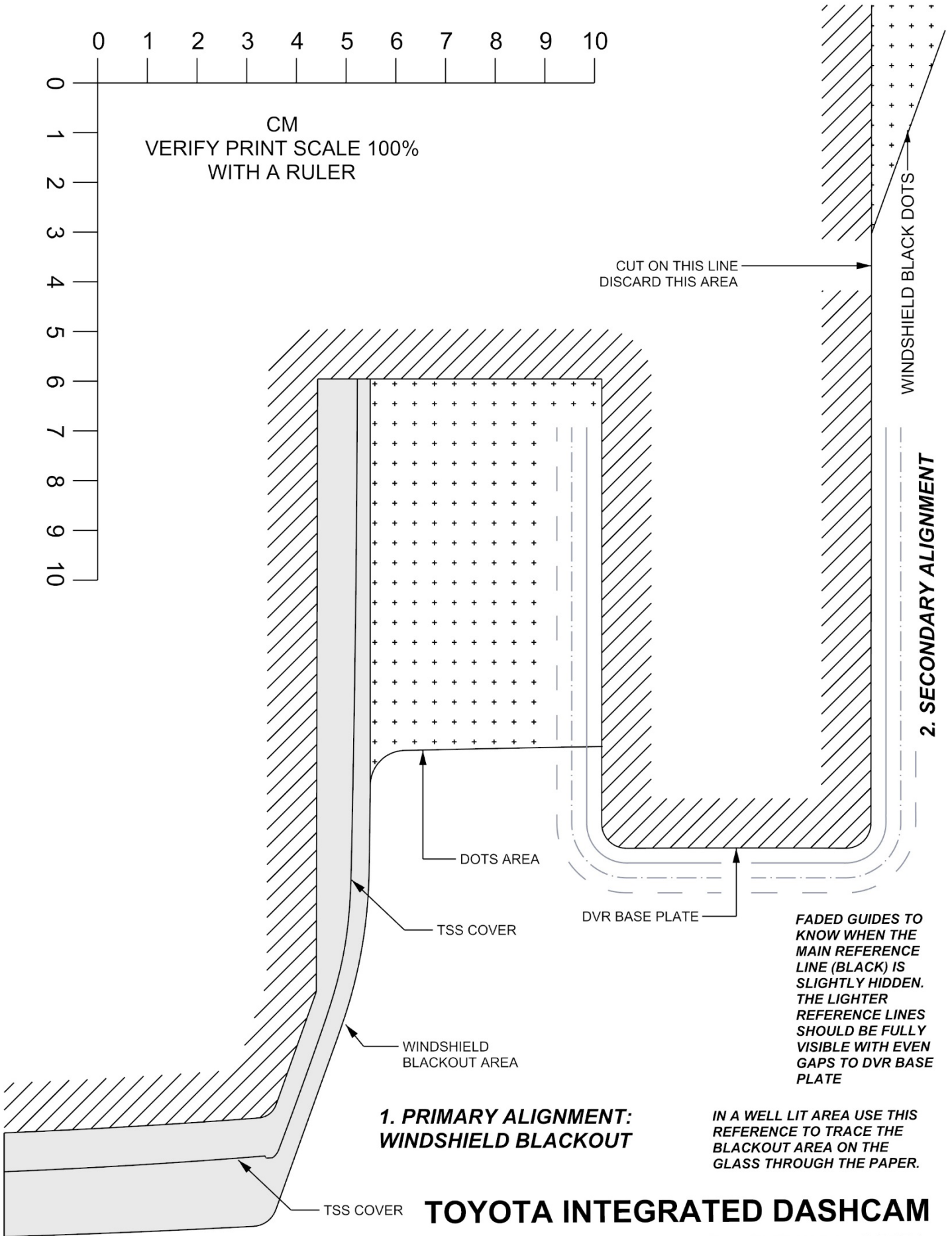
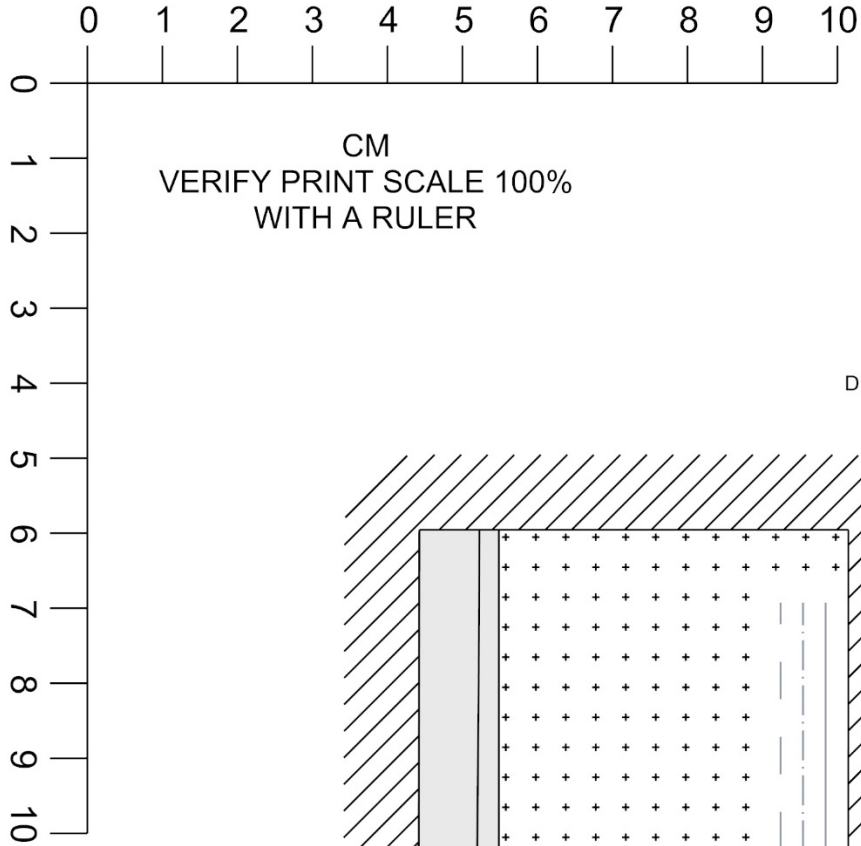

**1. PRIMARY ALIGNMENT:
WINDSHIELD BLACKOUT**

FADED GUIDES TO KNOW WHEN THE MAIN REFERENCE LINE (BLACK) IS SLIGHTLY HIDDEN. THE LIGHTER REFERENCE LINES SHOULD BE FULLY VISIBLE WITH EVEN GAPS TO DVR BASE PLATE

IN A WELL LIT AREA USE THIS REFERENCE TO TRACE THE BLACKOUT AREA ON THE GLASS THROUGH THE PAPER.

TOYOTA INTEGRATED DASHCAM 2023+ PRIUS RHS TEMPLATE

TOYOTA MY23 PRIUS 2023 - DASHCAM (Digital Video Recorder)
 Checklist - these points **MUST** be checked to ensure a quality installation.

Check:	Look For:
<p><u>Accessory Function Checks</u></p> <ul style="list-style-type: none"> <input type="checkbox"/> Verify parts <input type="checkbox"/> Vehicle Startup <input type="checkbox"/> Power LEDs light up <input type="checkbox"/> Remove Blue Film on Dashcam Lens <input type="checkbox"/> Verify that Dashcam Pamphlet is placed in glovebox. 	<p>Removed items have been discarded & replaced items are in place</p> <p>Confirm Dashcam does not emit a continuous beep on vehicle startup. If it does, confirm SD card is installed</p> <p>Blue Lens Protector Film should be removed and discarded.</p>
<p><u>Vehicle Function Checks</u></p> <ul style="list-style-type: none"> <input type="checkbox"/> Standard exterior lights - low / high beams, left / right turn signal, emergency signal <input type="checkbox"/> Roof Console functions – map lights, sunroof / panoramic roof controls if equipped. <input type="checkbox"/> EC Mirror – Confirm power and dimming. <input type="checkbox"/> Mirror – View Angle 	<p>Confirm standard lighting functions work properly.</p> <p>Confirm roof console functions work properly.</p> <p>Confirm EC Mirror power status LED visible, cover the transparent lens on the reverse side with your hand, the mirror glass should fade darker after a few seconds.</p> <p>Confirm mirror is adjusted correctly for visibility for the average driver.</p>
<p><u>Vehicle Appearance Check</u></p> <ul style="list-style-type: none"> <input type="checkbox"/> After accessory installation and removal of protective cover(s), perform a visual inspection. <input type="checkbox"/> All Templates and Tools removed from the vehicle. 	<p>Ensure no damage (including scuffs and scratches) was caused during the installation process. (For PPO installations, refer to TMNA Accessory Quality Shipping Standard.)</p> <p>Confirm Windshield Template and all tools have been removed from the vehicle.</p>