

\* 1 : w/ Navigation Receiver Assembly Type  
\* 2 : w/ Radio & Display Receiver Assembly Type

L111(A), L127(B), L128(C), L130(D), L131(E)  
 Navigation Receiver Assembly  
 L138(F), L148(I), L149(J), z22(M), z23(N)  
 Radio & Display Receiver Assembly

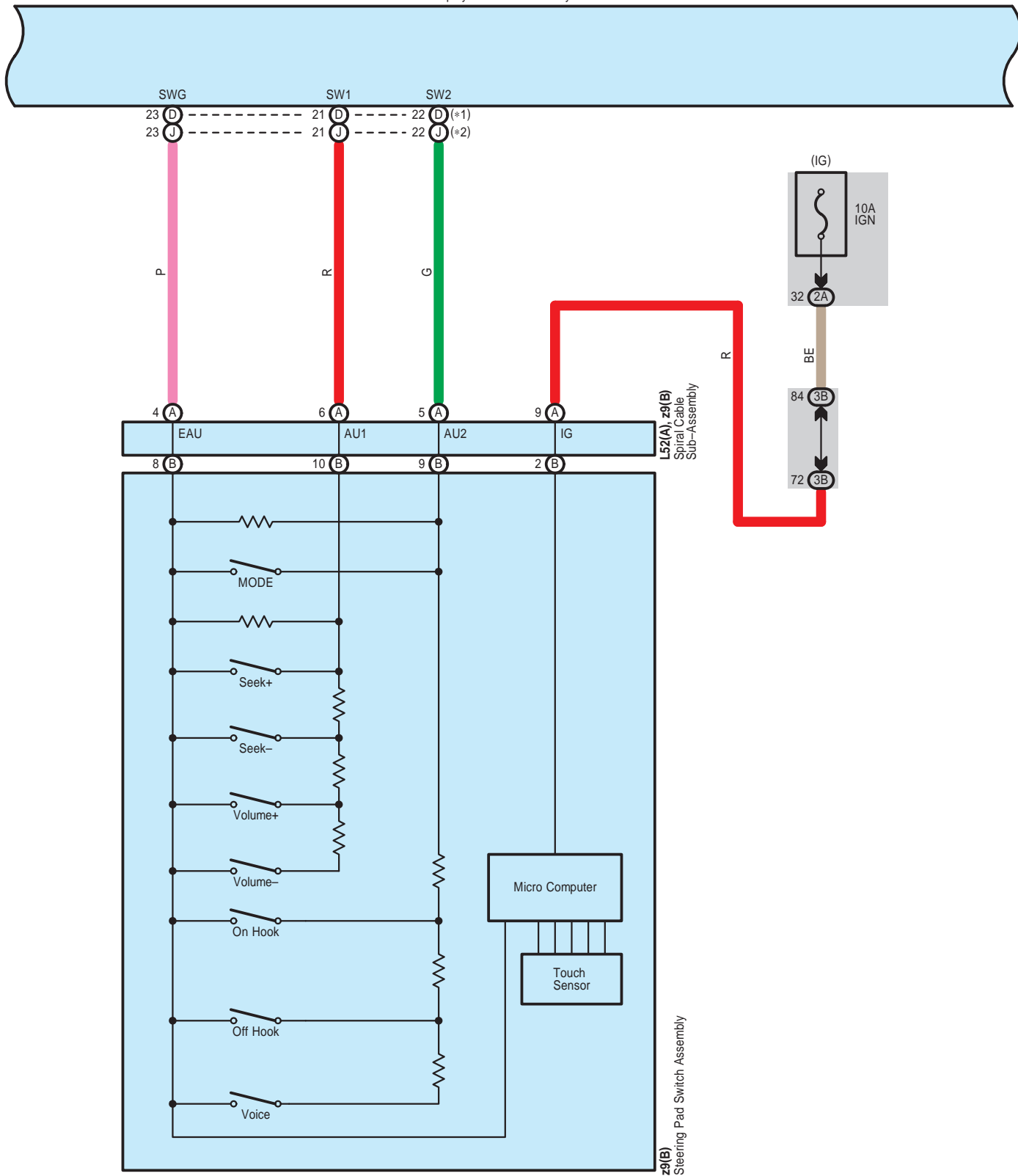

L111(A), L127(B), L128(C), L130(D), L131(E)  
 Navigation Receiver Assembly  
 L138(F), L148(I), L149(J), z22(M), z23(N)  
 Radio & Display Receiver Assembly

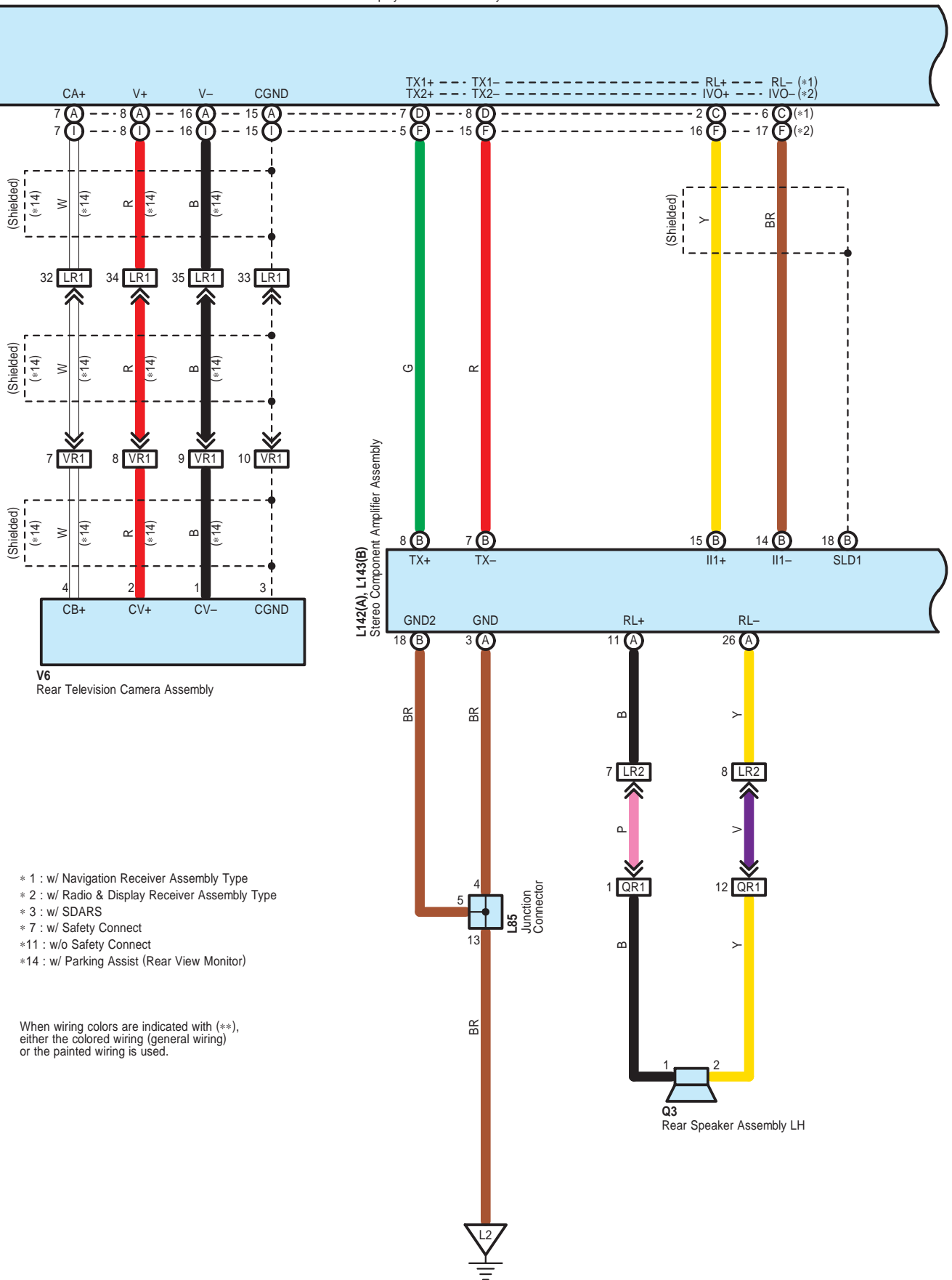

- \* 1 : w/ Navigation Receiver Assembly Type
- \* 2 : w/ Radio & Display Receiver Assembly Type
- \* 3 : w/ SDARS
- \* 7 : w/ Safety Connect
- \*11 : w/o Safety Connect
- \*14 : w/ Parking Assist (Rear View Monitor)

When wiring colors are indicated with (\*\*), either the colored wiring (general wiring) or the painted wiring is used.

L111(A), L127(B), L128(C), L130(D), L131(E)  
 Navigation Receiver Assembly  
 L138(F), L148(I), L149(J), z22(M), z23(N)  
 Radio & Display Receiver Assembly

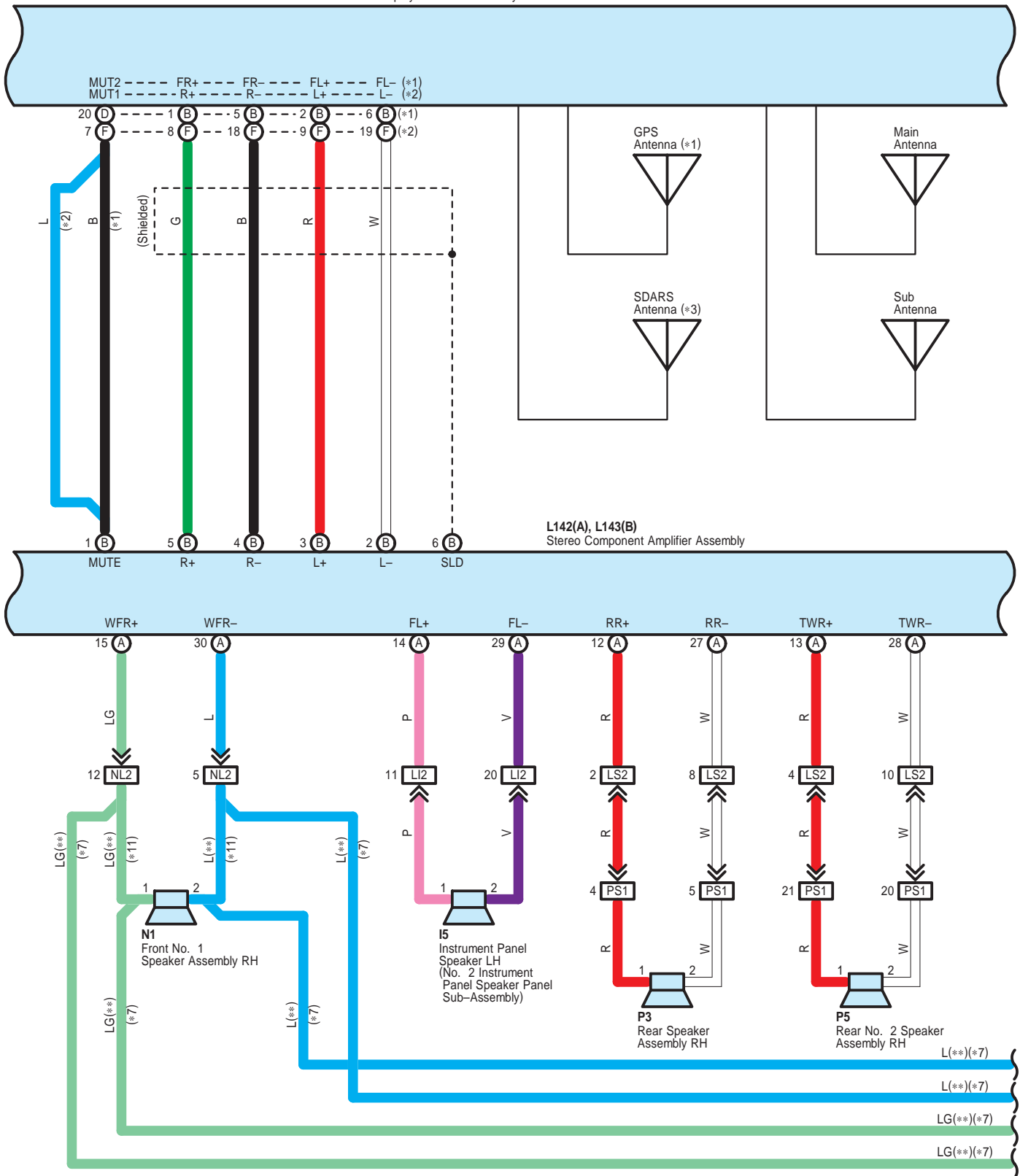

L111(A), L127(B), L128(C), L130(D), L131(E)  
 Navigation Receiver Assembly  
 L138(F), L148(I), L149(J), z22(M), z23(N)  
 Radio & Display Receiver Assembly

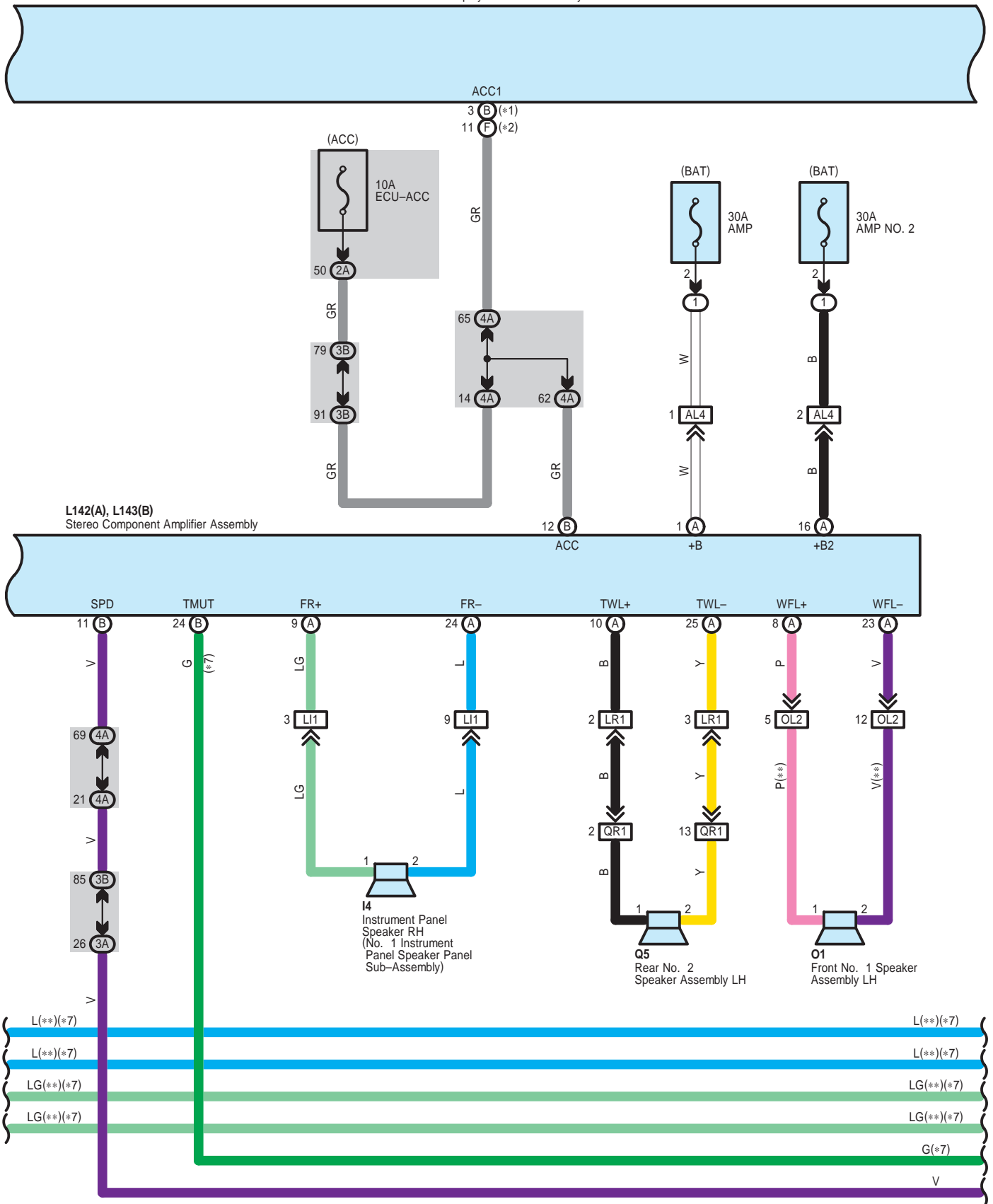

L111(A), L127(B), L128(C), L130(D), L131(E)  
 Navigation Receiver Assembly  
 L138(F), L148(I), L149(J), z22(M), z23(N)  
 Radio & Display Receiver Assembly

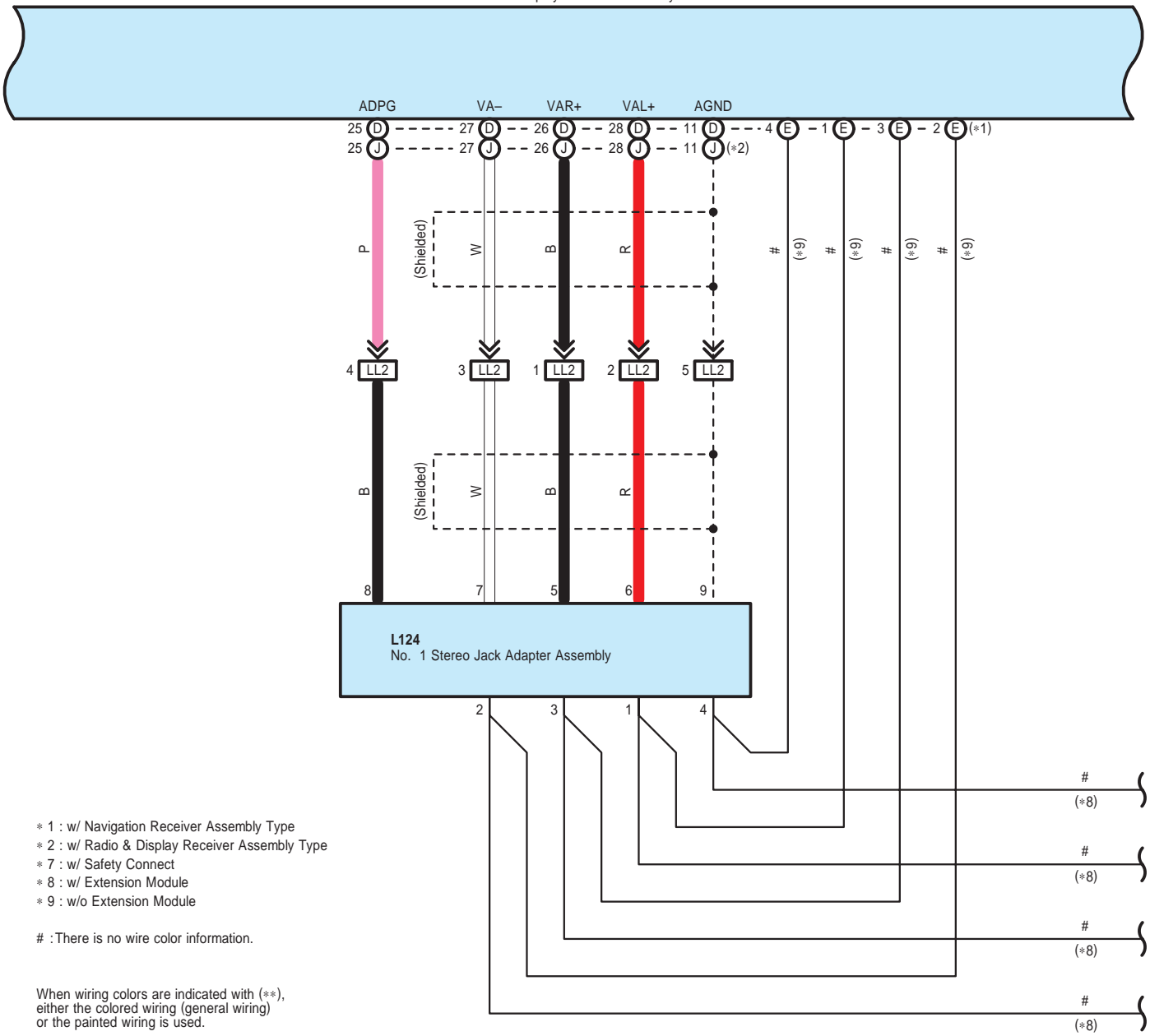

L111(A), L127(B), L128(C), L130(D), L131(E)  
 Navigation Receiver Assembly  
 L138(F), L148(I), L149(J), z22(M), z23(N)  
 Radio & Display Receiver Assembly

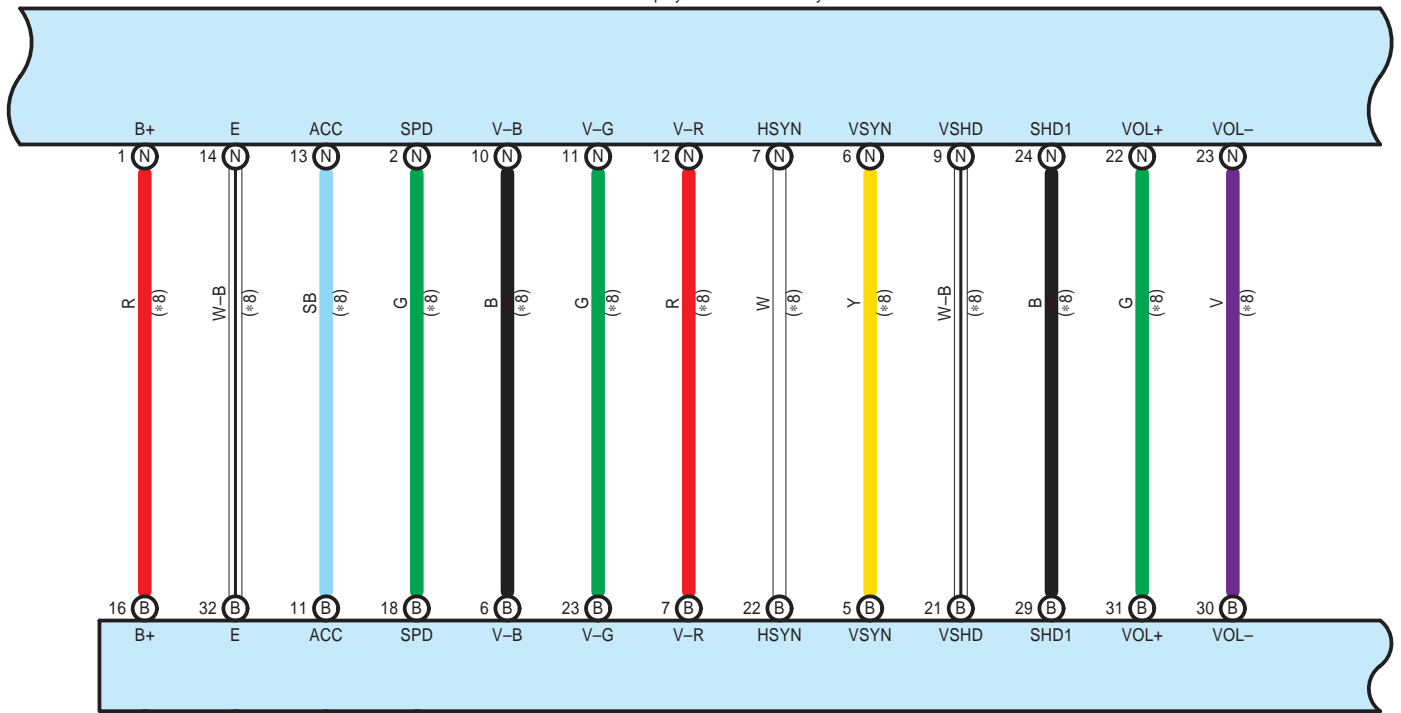

L151(A), z21(B)  
 Extension Module

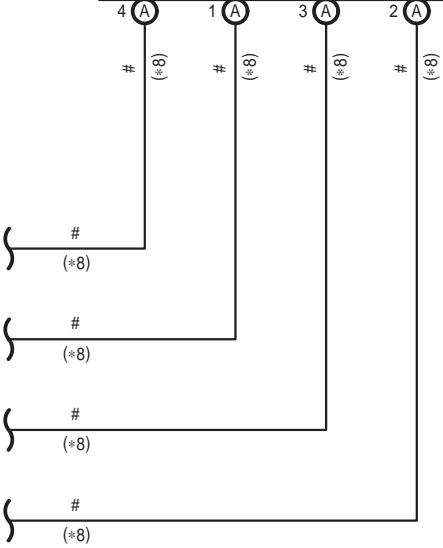

\* 7 : w/ Safety Connect  
 \* 8 : w/ Extension Module

# : There is no wire color information.

When wiring colors are indicated with (\*\*),  
 either the colored wiring (general wiring)  
 or the painted wiring is used.



L111(A), L127(B), L128(C), L130(D), L131(E)  
 Navigation Receiver Assembly  
 L138(F), L148(I), L149(J), z22(M), z23(N)  
 Radio & Display Receiver Assembly

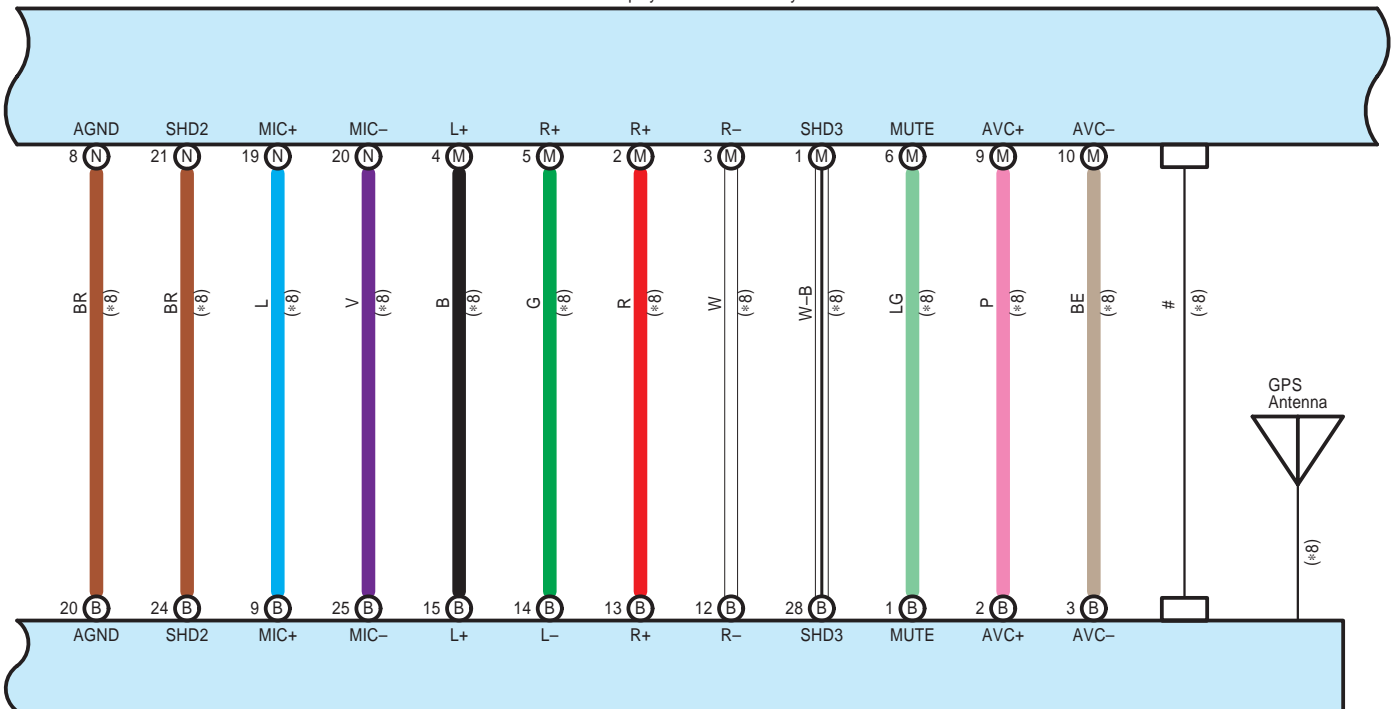

L151(A), z21(B)  
 Extension Module

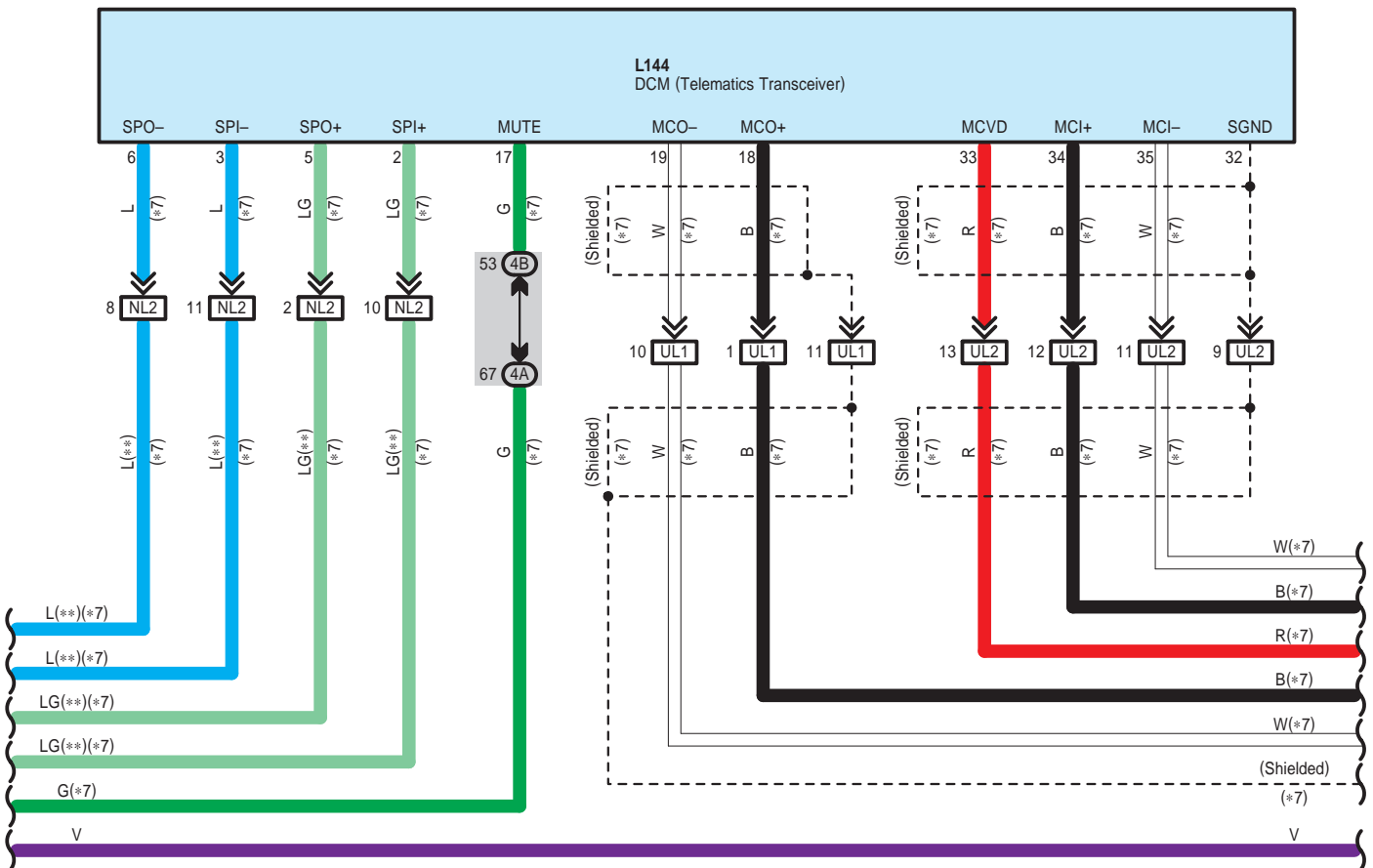



L111(A), L127(B), L128(C), L130(D), L131(E)  
 Navigation Receiver Assembly  
 L138(F), L148(I), L149(J), z22(M), z23(N)  
 Radio & Display Receiver Assembly

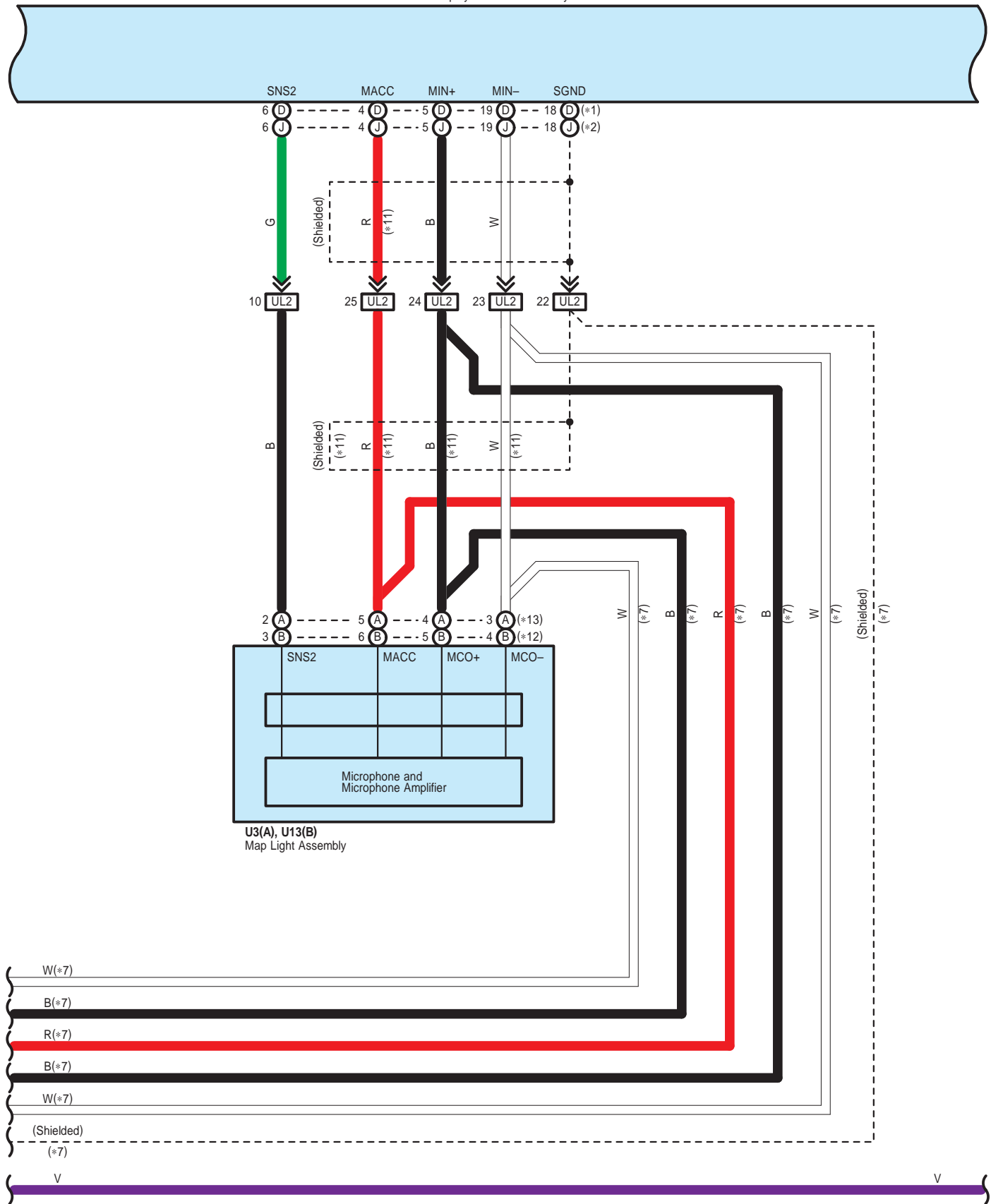

L111(A), L127(B), L128(C), L130(D), L131(E)  
 Navigation Receiver Assembly  
 L138(F), L148(I), L149(J), z22(M), z23(N)  
 Radio & Display Receiver Assembly

- \* 1 : w/ Navigation Receiver Assembly Type
- \* 2 : w/ Radio & Display Receiver Assembly Type
- \* 7 : w/ Safety Connect
- \* 11 : w/o Safety Connect
- \* 12 : w/ Sliding Roof
- \* 13 : w/o Sliding Roof

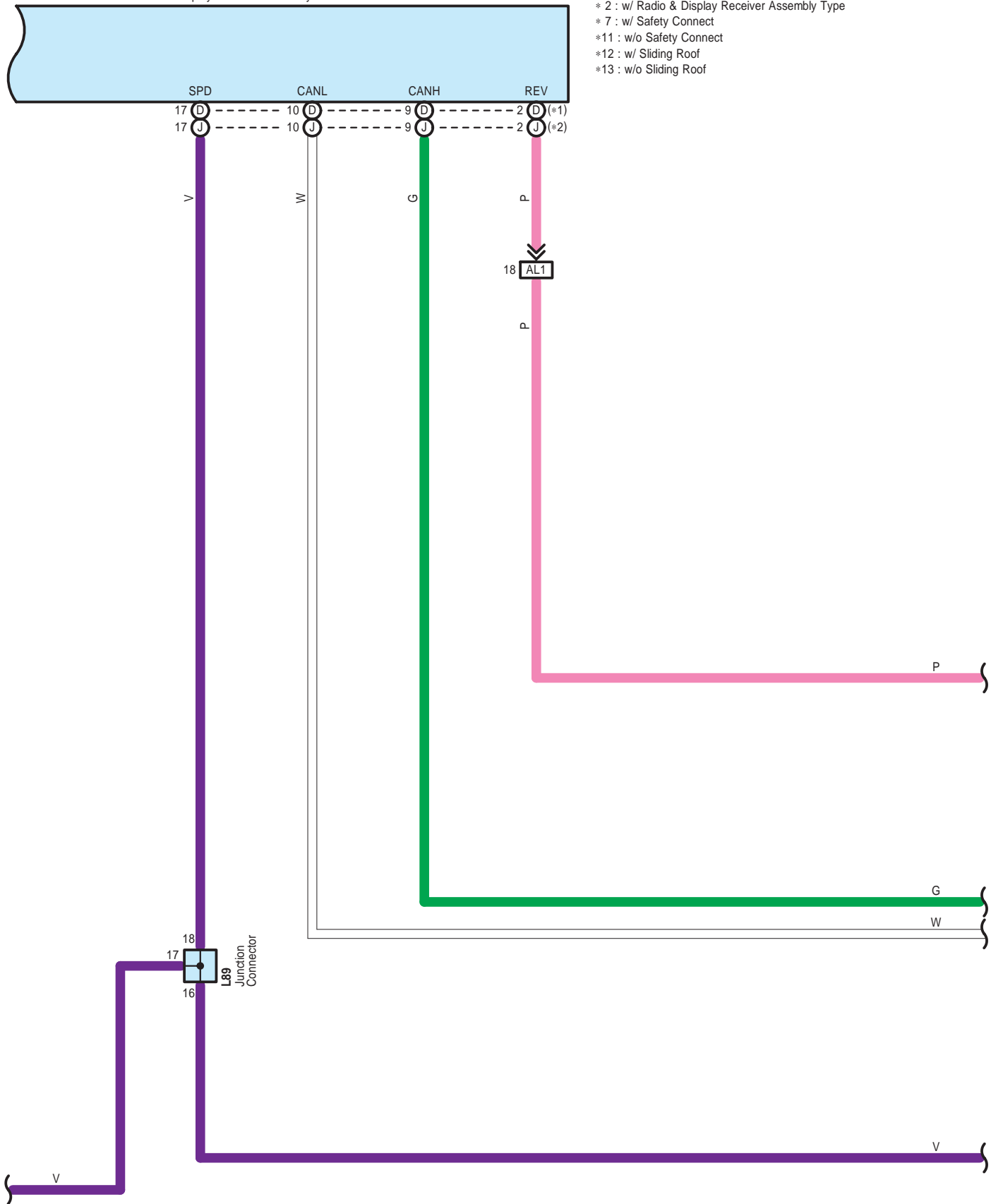

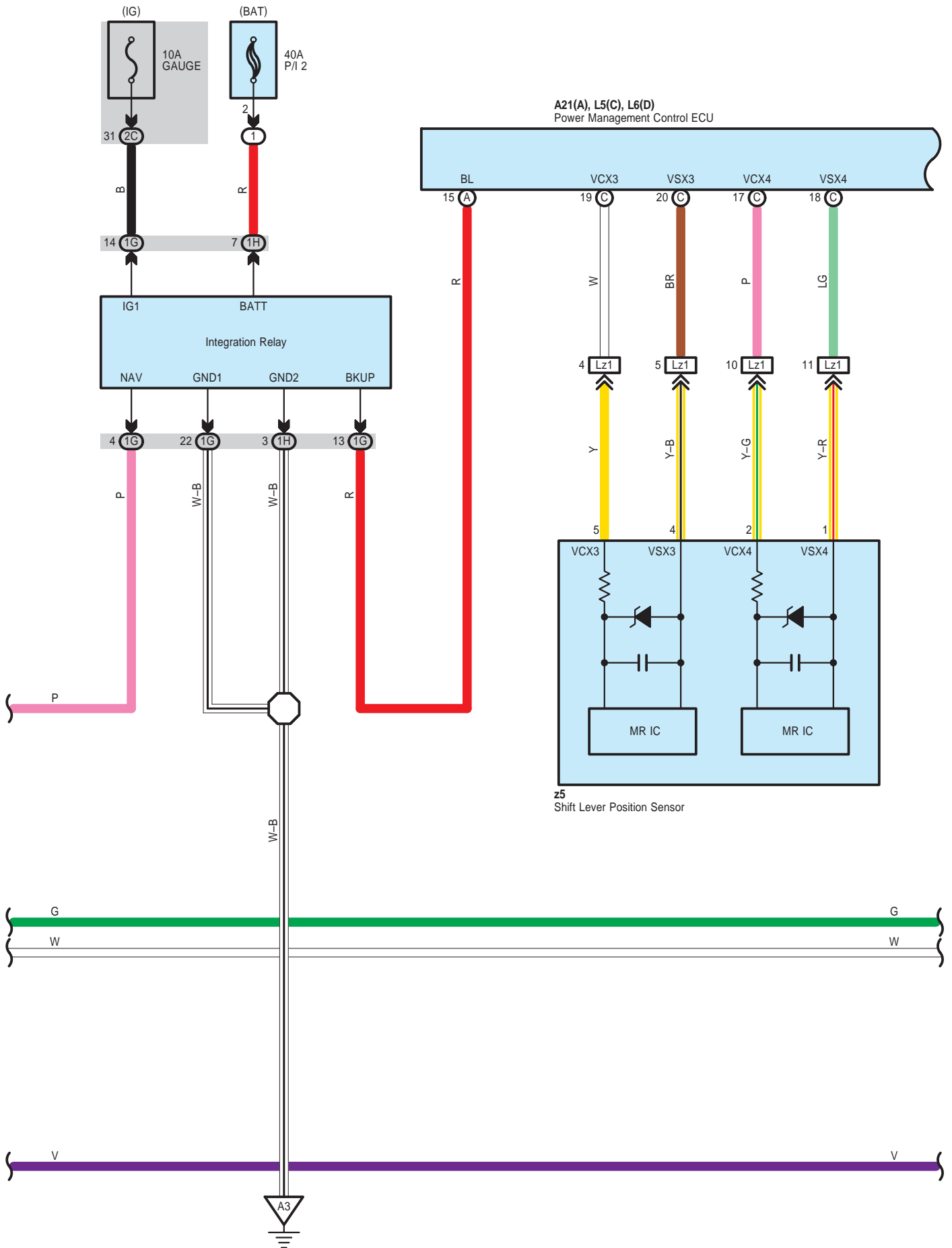

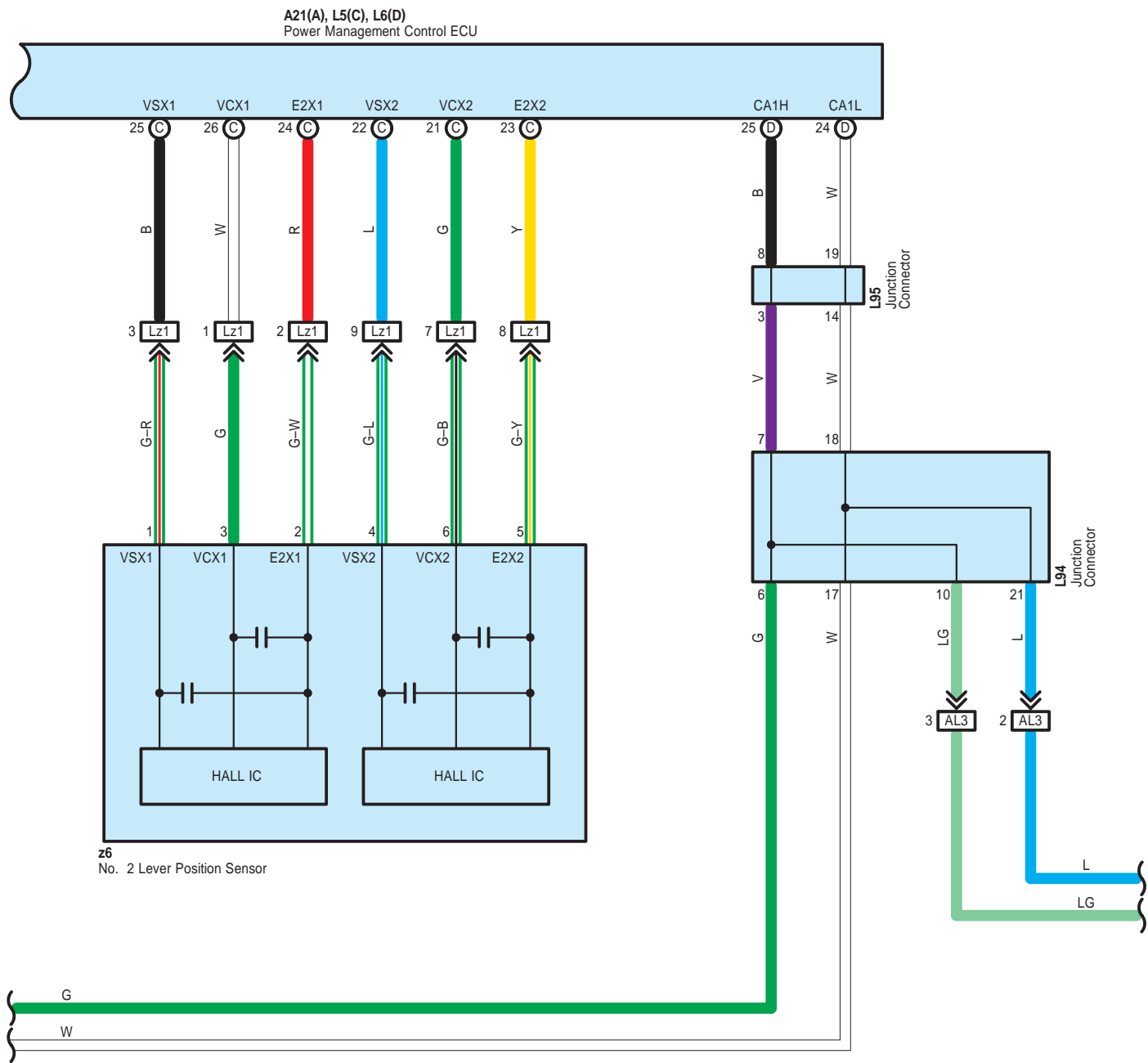

**A58**  
Skid Control ECU with Actuator Assembly

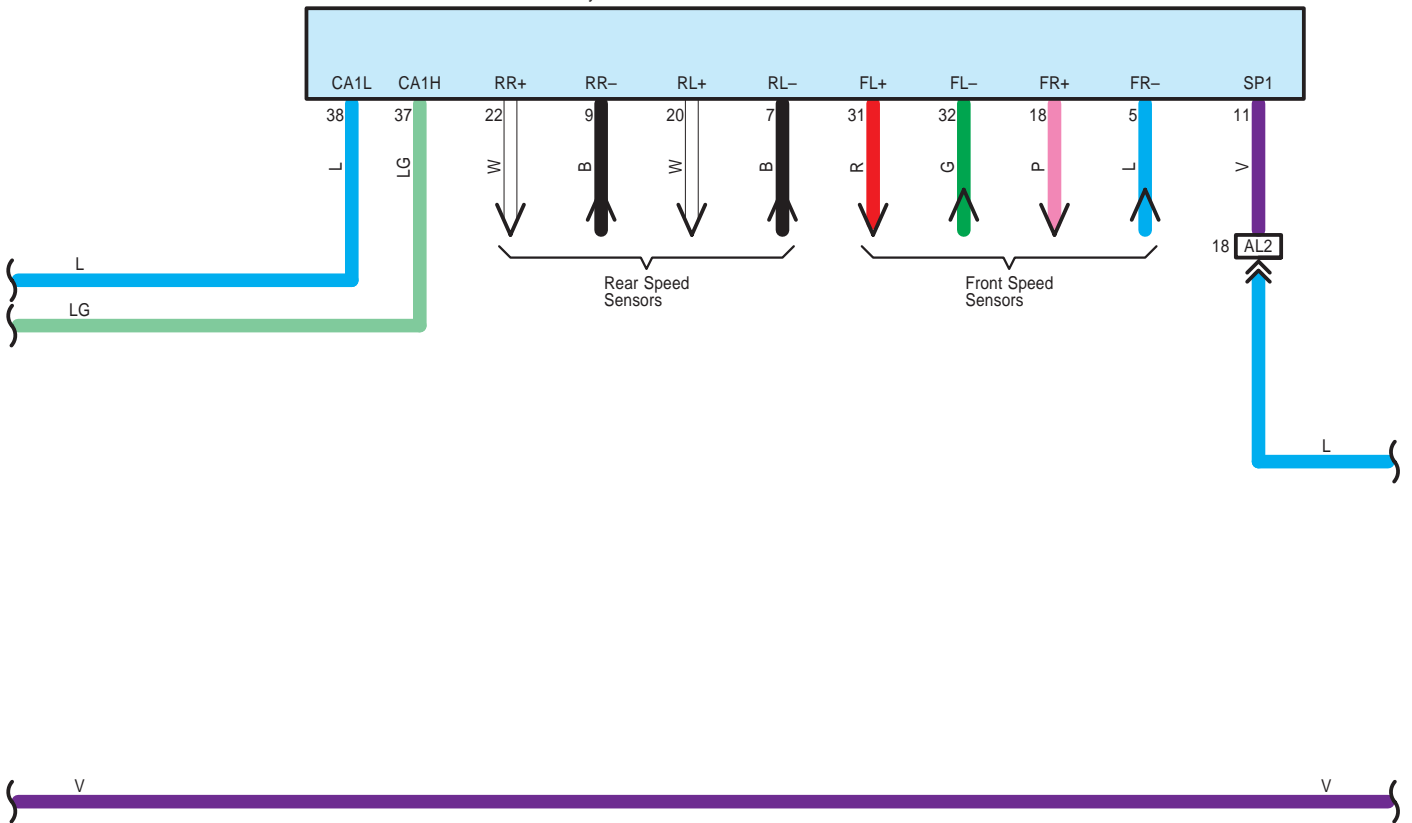

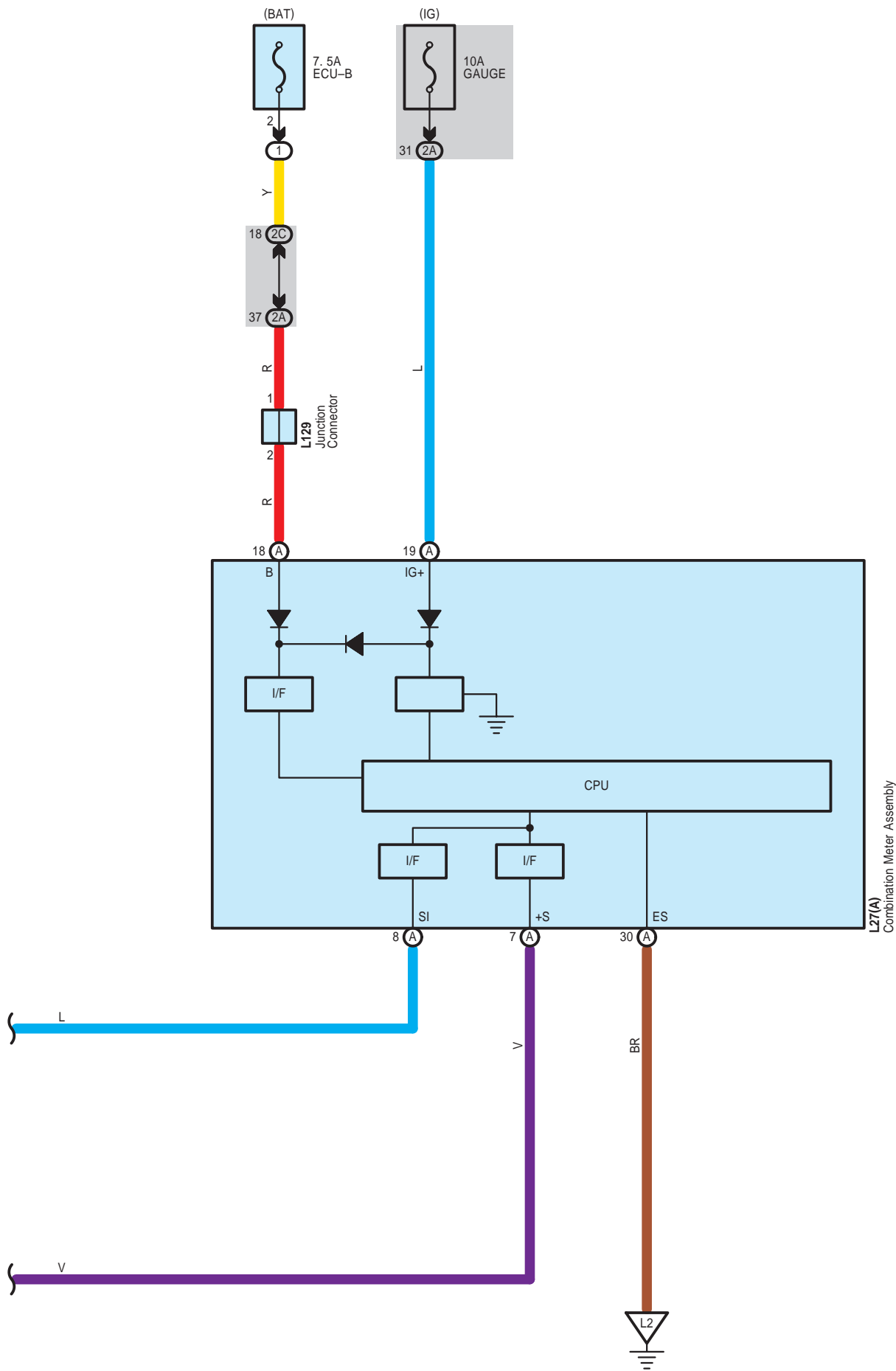

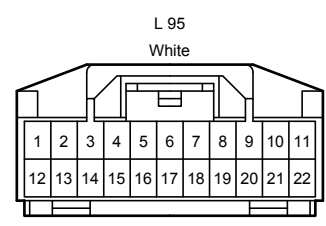
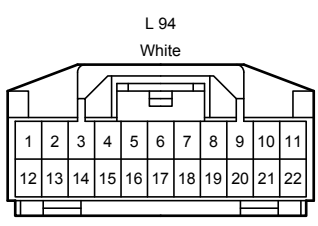
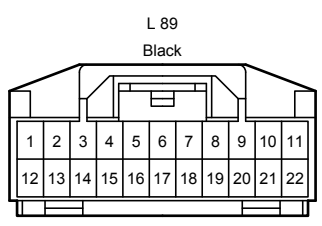
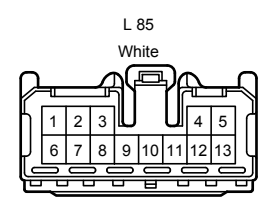
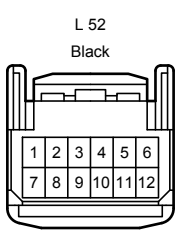
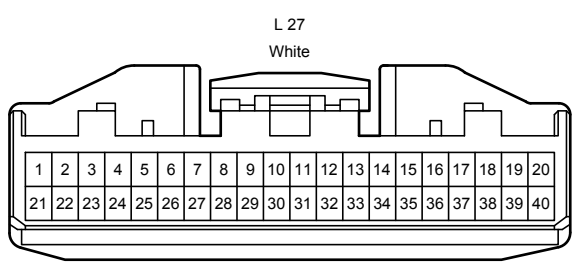
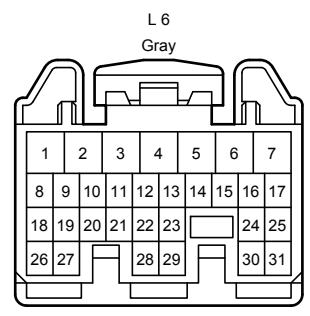
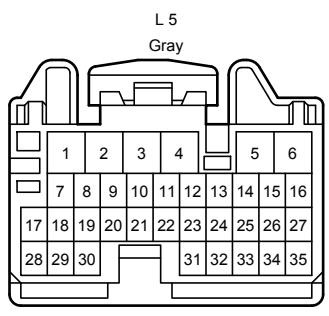
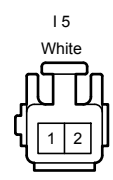
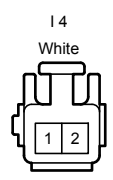
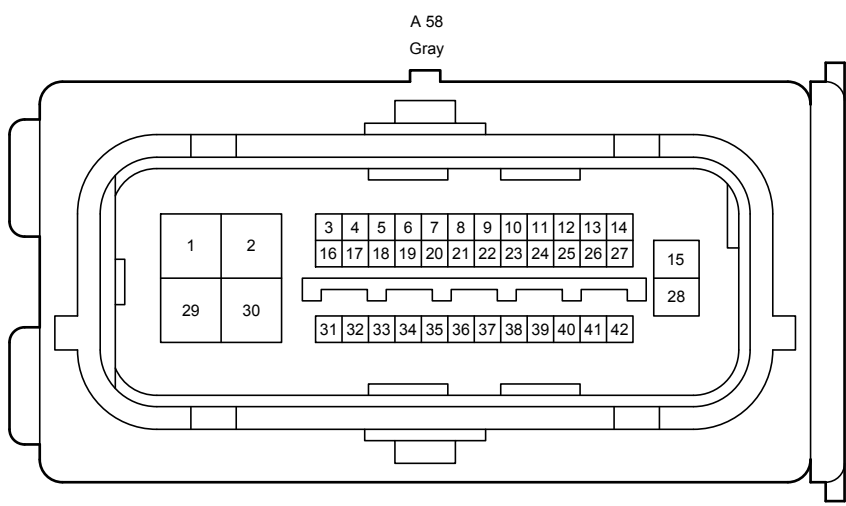
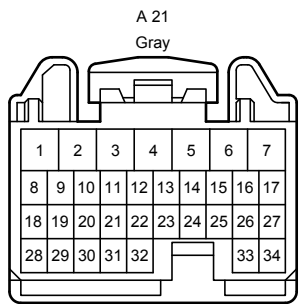

L111  
White

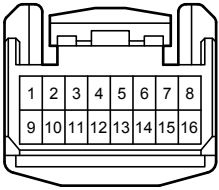

L124  
Black

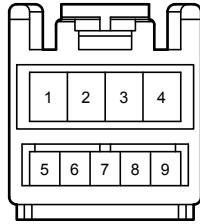

L127  
White

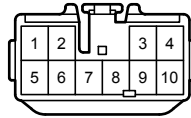

L128  
White

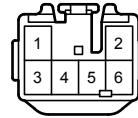

L129  
Gray

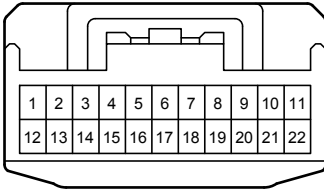

L130  
White

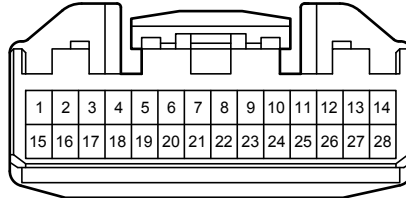

L131  
Gray

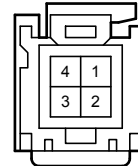

L138  
White

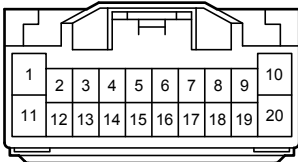

L142  
White

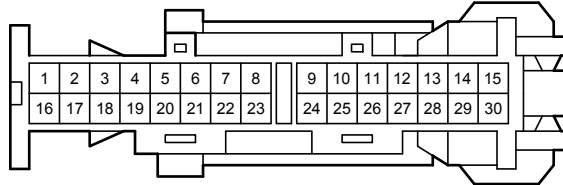

L143  
White

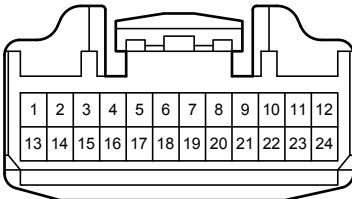

L144  
White

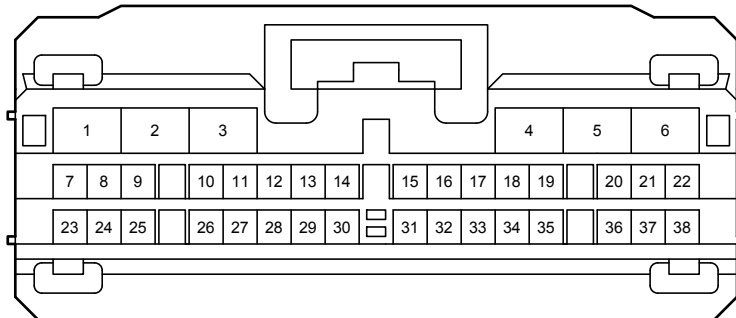

L148  
White

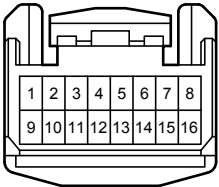

L149  
White

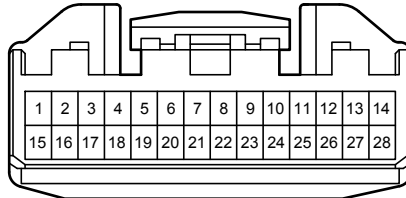

L151  
Gray

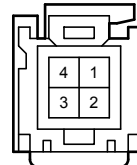

N 1  
White



O 1  
White

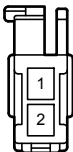

P 3  
Black

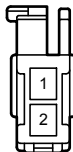

P 5  
White

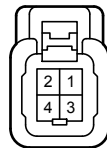

Q 3  
Black



Q 5  
White

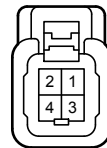

U 3  
White

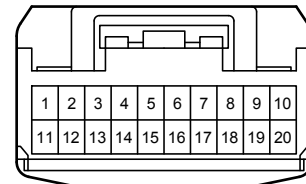



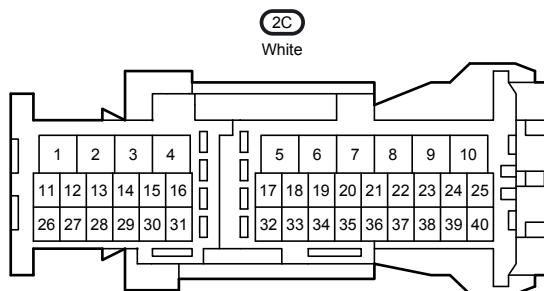
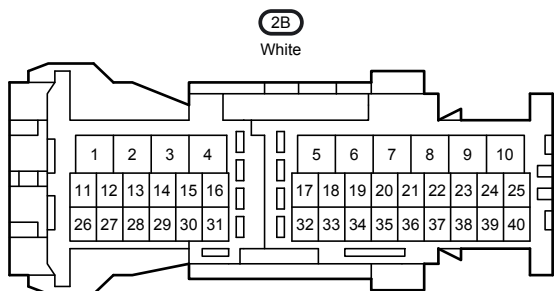
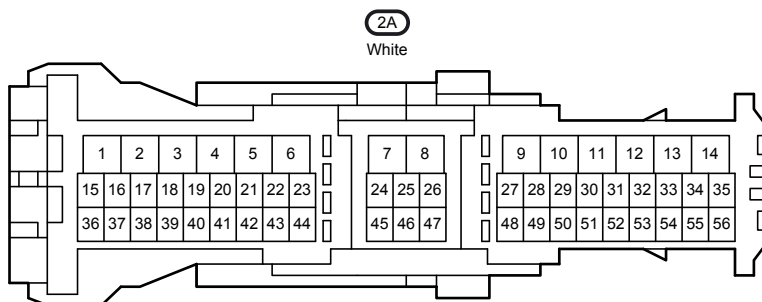
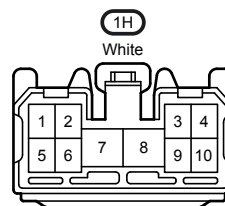
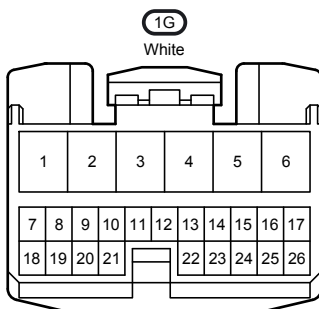
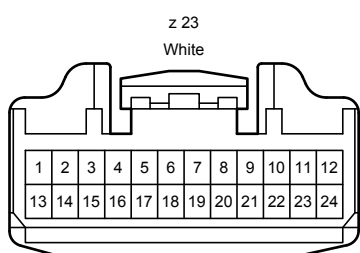
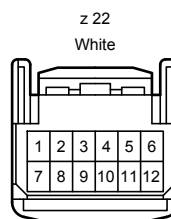
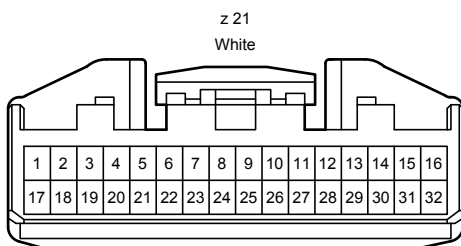
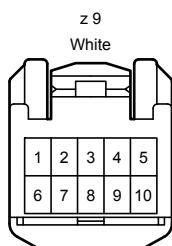
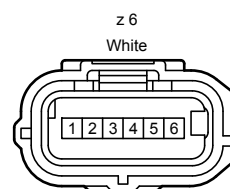
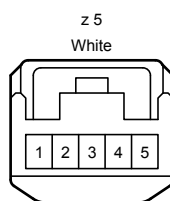
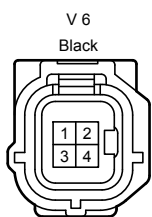
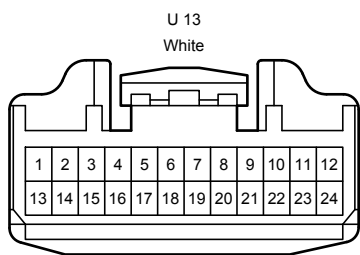

3A  
White

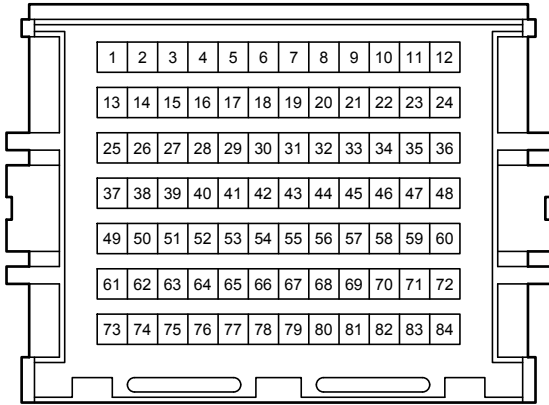

3B  
White

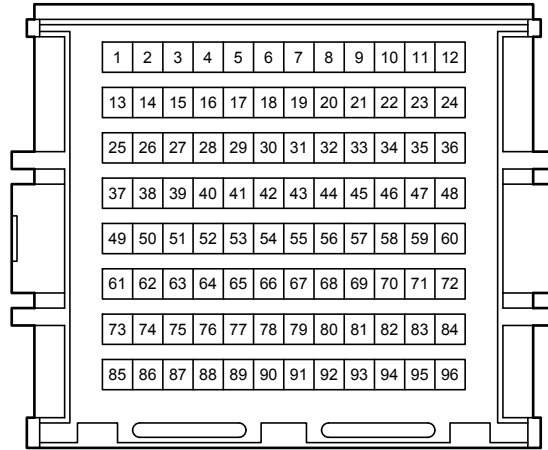

4A  
White

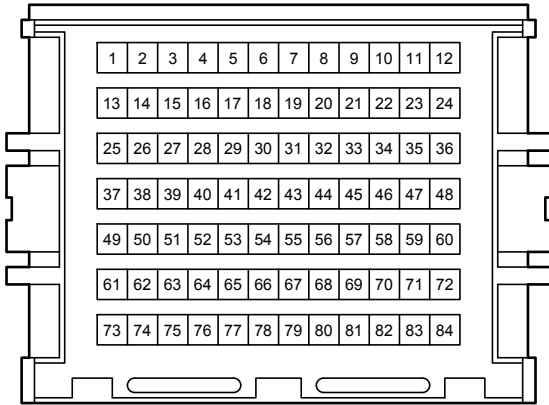

4B  
White

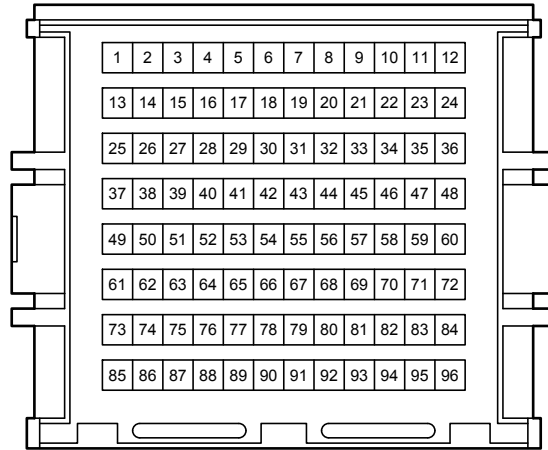

AL1  
Blue

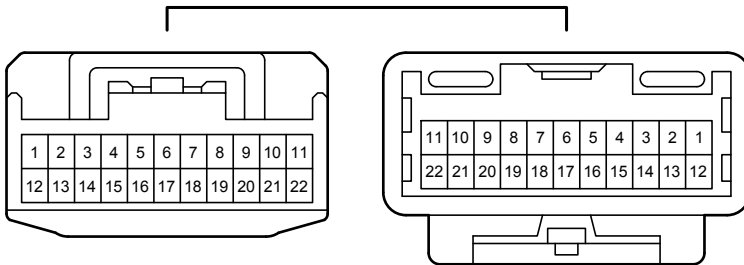

AL2  
Gray

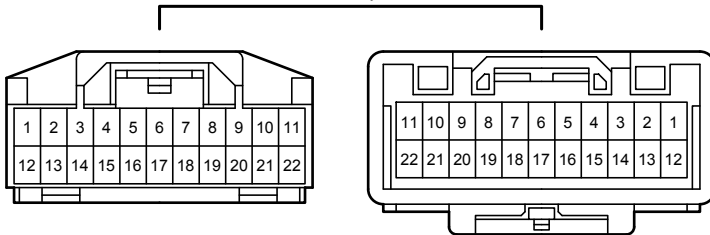

AL3  
White

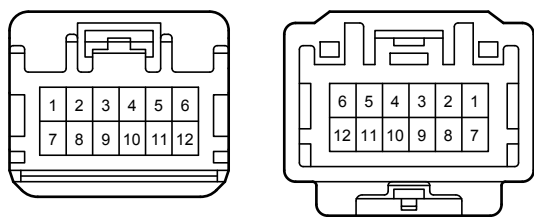

AL4  
Black

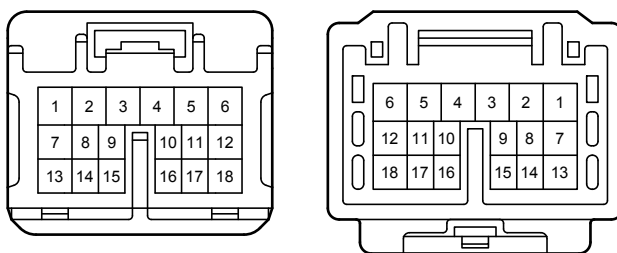

L11  
Black

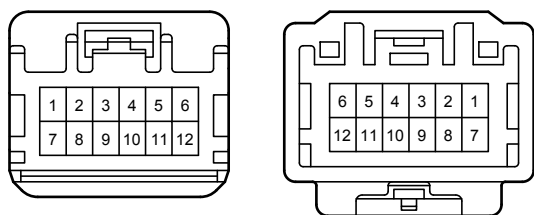

L12  
White

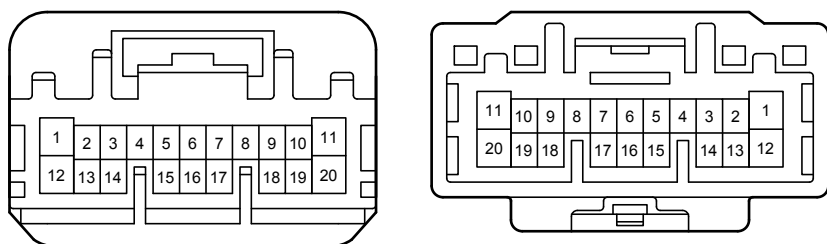

LL2  
White

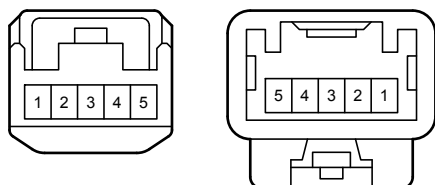

LR1  
White

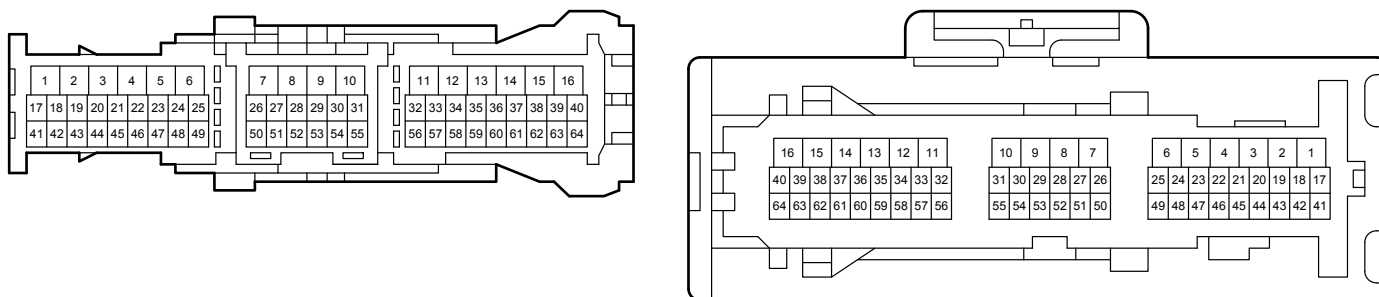

LR2  
Black

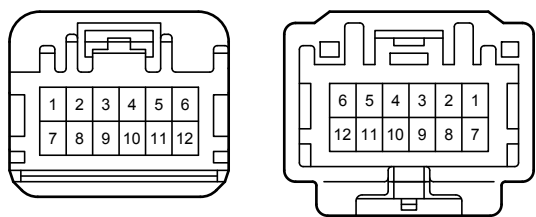

LS2  
Black

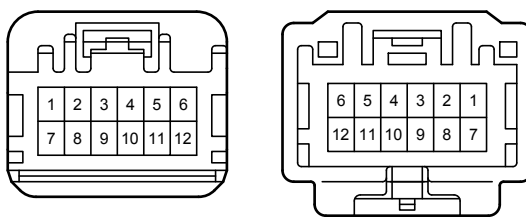

Lz1  
White

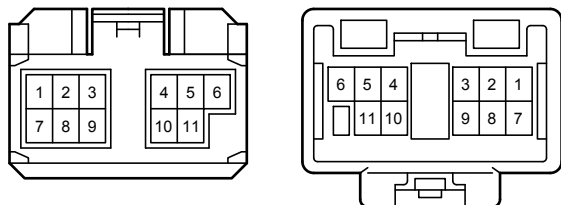

NL2  
White

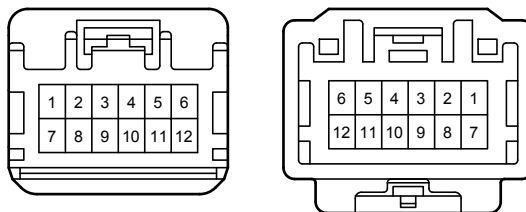

OL2  
White

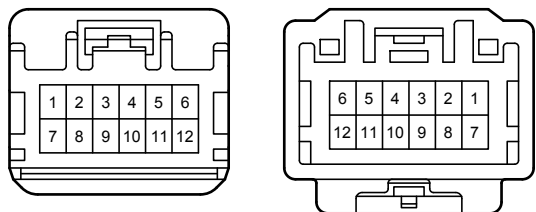

PS1  
White

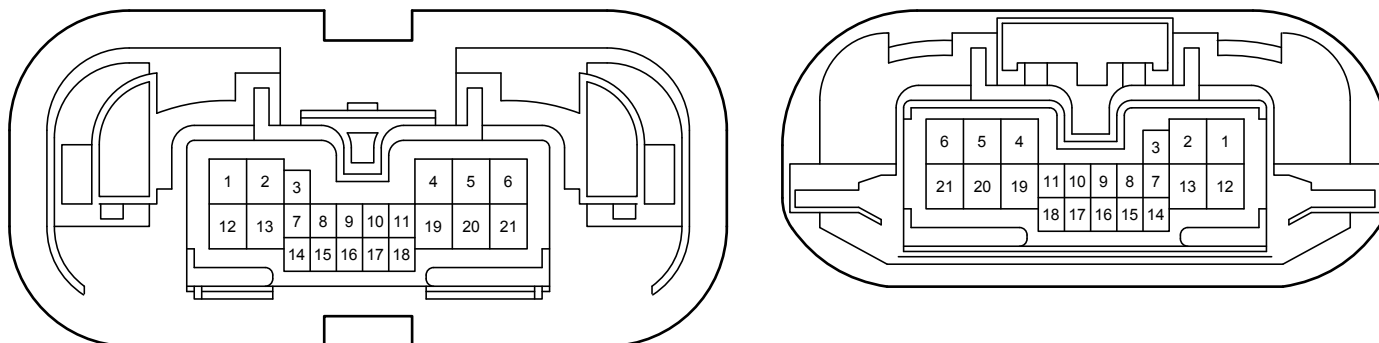

QR1  
White

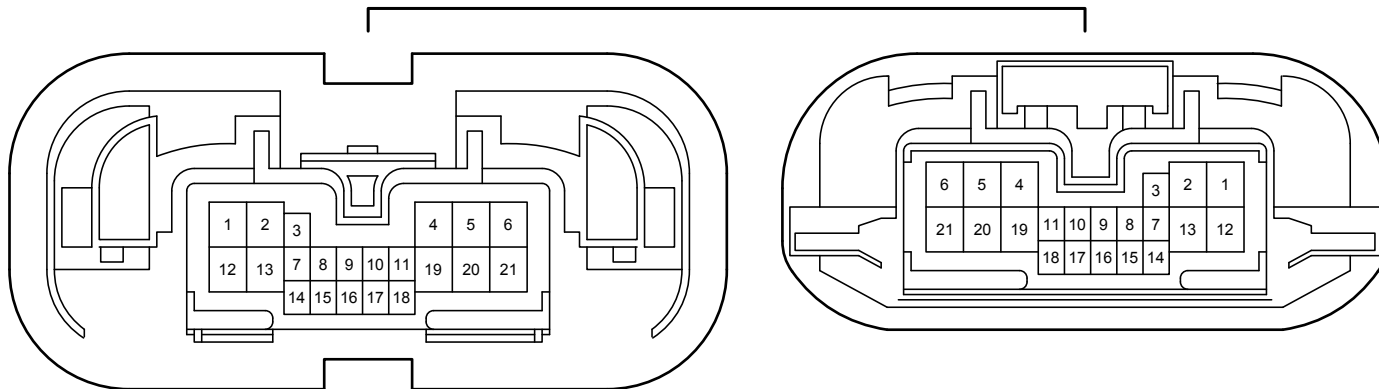

UL1  
Gray

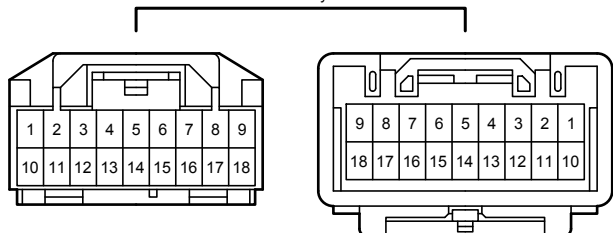

UL2  
White

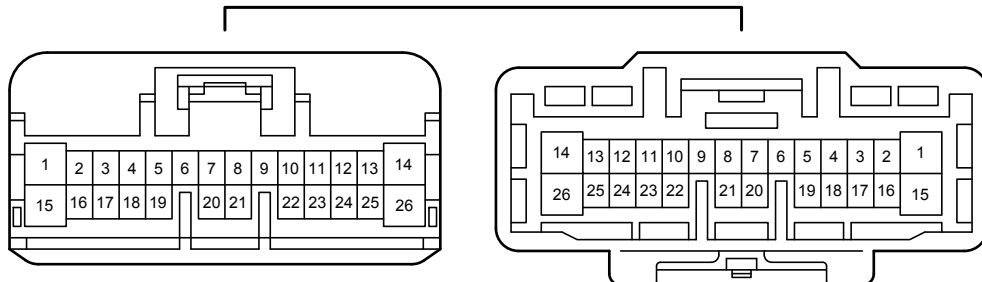

VR1  
White

