

<b>Last Modified:</b> 03-26-2024	6.11:8.1.0	<b>Doc ID:</b> RM1000000029023
<b>Model Year Start:</b> 2023	<b>Model:</b> Prius Prime	<b>Prod Date Range:</b> [12/2022 - ]
<b>Title:</b> MIRROR (EXT): OUTER REAR VIEW MIRROR: DISASSEMBLY; 2023 - 2024 MY Prius Prius Prime [12/2022 - ]		

## DISASSEMBLY

### CAUTION / NOTICE / HINT



**HINT:**

- Use the same procedure for the RH side and LH side.
- The following procedure is for the LH side.

### CAUTION / NOTICE / HINT

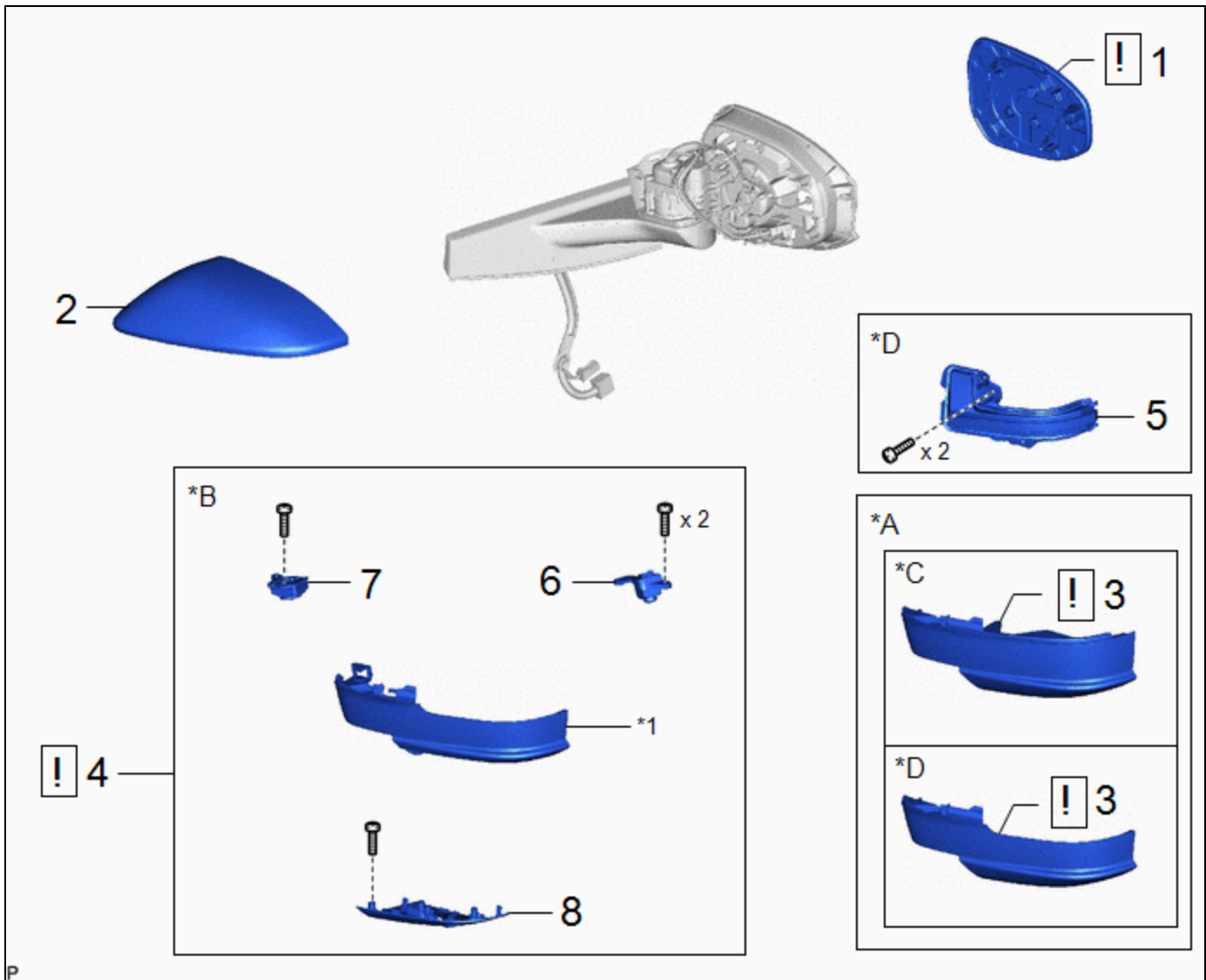
#### COMPONENTS (DISASSEMBLY)



PROCEDURE		PART NAME CODE			
1	OUTER MIRROR	87961	INFO	-	-
2	OUTER MIRROR COVER	87945	-	-	-
3	NO. 3 OUTER MIRROR COVER	8794BA	INFO	-	-
4	NO. 3 OUTER MIRROR COVER WITH TELEVISION CAMERA	-	INFO	-	-
5	SIDE TURN SIGNAL LIGHT ASSEMBLY	81740	-	-	-
6	SIDE TELEVISION CAMERA ASSEMBLY	86790F	-	-	-
7	PARKING ASSIST LIGHT	867A2A	-	-	-
8	OUTER MIRROR HOLE COVER	-	-	-	-

*A	w/o Panoramic View Monitor System	*B	w/ Panoramic View Monitor System
*C	w/o Side Turn Signal Light	*D	w/ Side Turn Signal Light
*1	NO. 3 OUTER MIRROR COVER	-	-

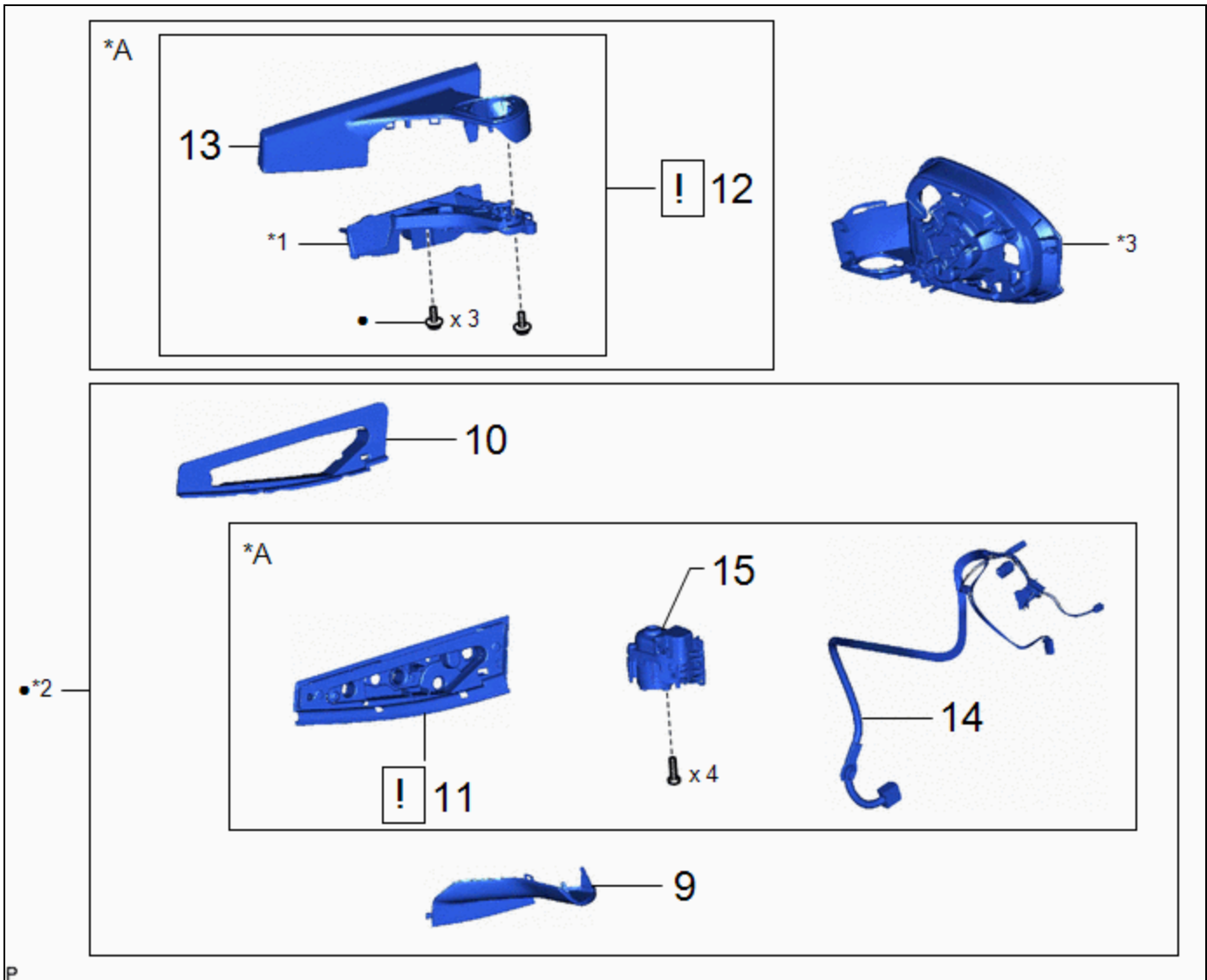

PROCEDURE		PART NAME CODE			
9	LOWER BASE COVER	-	-	-	-
10	OUTER REAR VIEW MIRROR PACKING	87926A	-	-	-
11	GASKET	-	INFO	-	-
12	OUTER MIRROR BASE	-	INFO	-	-
13	NO. 2 OUTER MIRROR COVER	8794A	-	-	-
14	WIRE HARNESS ASSEMBLY	-	-	-	-
15	OUTER MIRROR RETRACTOR UNIT	-	-	-	-

*A	w/ Automatic Retractable Mirror	-	-
*1	BASE	*2	OUTER MIRROR RETRACTOR
*3	HOUSING	-	-

• Non-reusable part	-	-
---------------------	---	---

## PROCEDURE

### 1. REMOVE OUTER MIRROR

	Click here <a href="#">INFO</a>
---	---------------------------------

### 2. REMOVE OUTER MIRROR COVER

Click here [INFO](#)

### 3. REMOVE NO. 3 OUTER MIRROR COVER (w/o Panoramic View Monitor System)

(a) w/o Side Turn Signal Light:





	Remove in this Direction	-	-
---	--------------------------	---	---

(1) Using a screwdriver with its tip wrapped with protective tape, disengage the 4 claws and guide.

(2) Disengage the 4 claws as shown in the illustration to remove the No. 3 outer mirror cover.

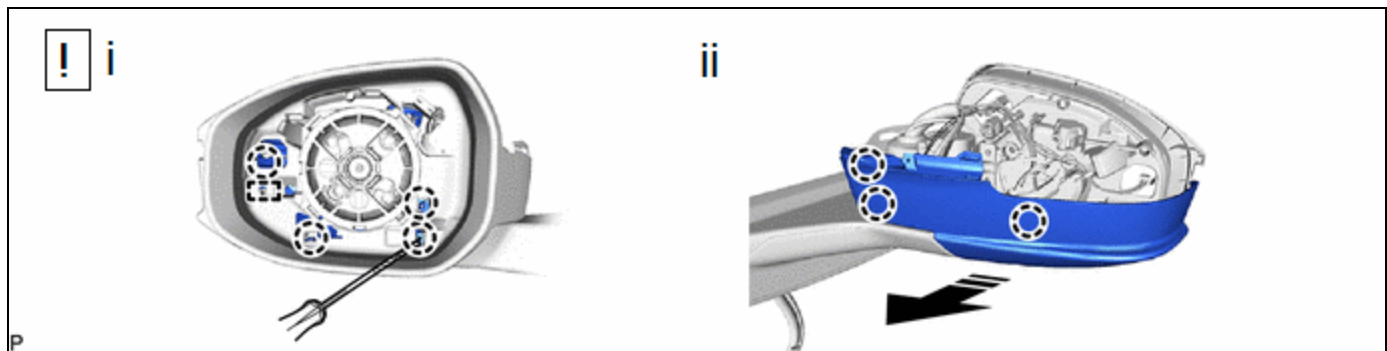
(b) w/ Side Turn Signal Light:



	Remove in this Direction	-	-
---	--------------------------	---	---

(1) Using a screwdriver with its tip wrapped with protective tape, disengage the 4 claws and guide.

(2) Disengage the 3 claws as shown in the illustration to remove the No. 3 outer mirror cover.

**4. REMOVE NO. 3 OUTER MIRROR COVER WITH TELEVISION CAMERA (w/ Panoramic View Monitor System)**

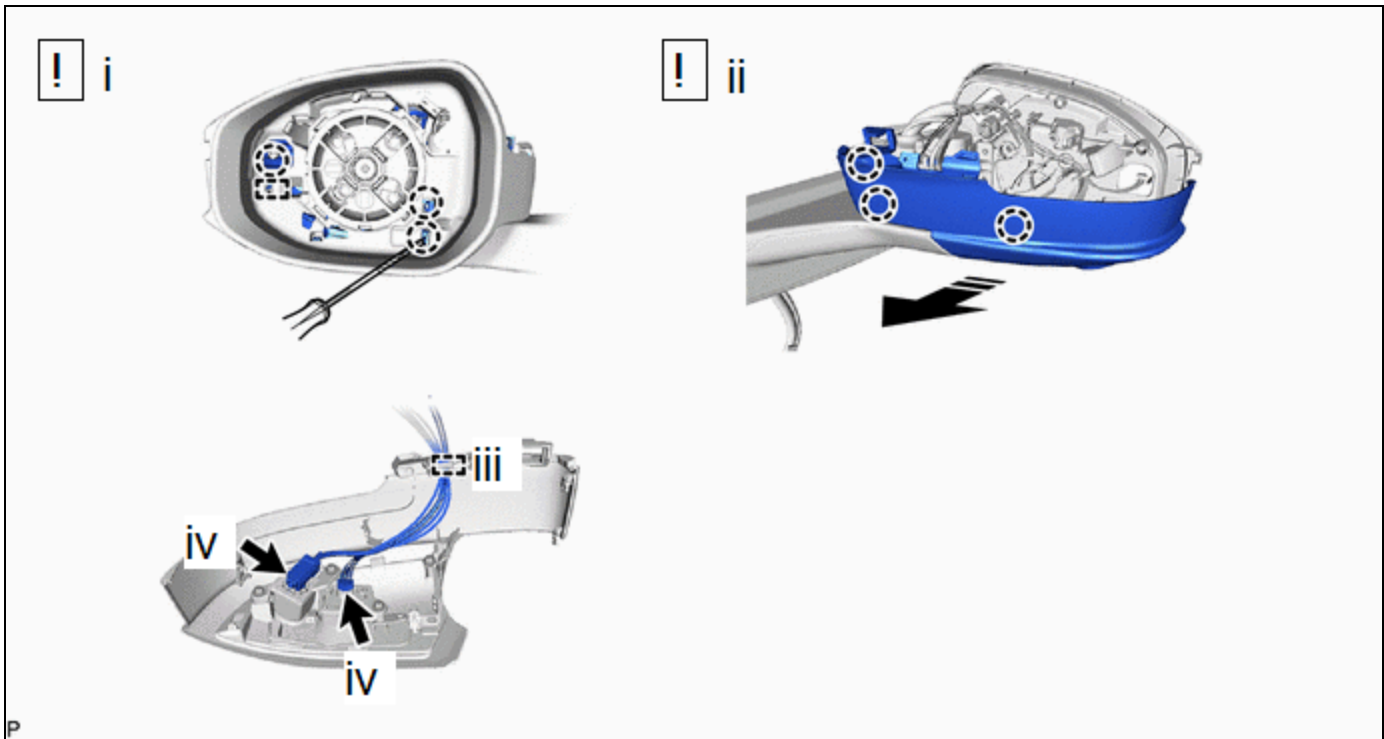

	Remove in this Direction	-	-
--	--------------------------	---	---

- (1) Using a screwdriver with its tip wrapped with protective tape, disengage the 3 claws and guide.
- (2) Disengage the 3 claws as shown in the illustration.
- (3) Disengage the clamp.
- (4) Disconnect the 2 connectors to remove the No. 3 outer mirror cover with television camera.

**5. REMOVE SIDE TURN SIGNAL LIGHT ASSEMBLY (w/ Side Turn Signal Light)**

Click here [INFO](#)

**6. REMOVE SIDE TELEVISION CAMERA ASSEMBLY (w/ Panoramic View Monitor System)**

Click here [INFO](#)

**7. REMOVE PARKING ASSIST LIGHT (w/ Panoramic View Monitor System)**

Click here [INFO](#)

**8. REMOVE OUTER MIRROR HOLE COVER (w/ Panoramic View Monitor System)**

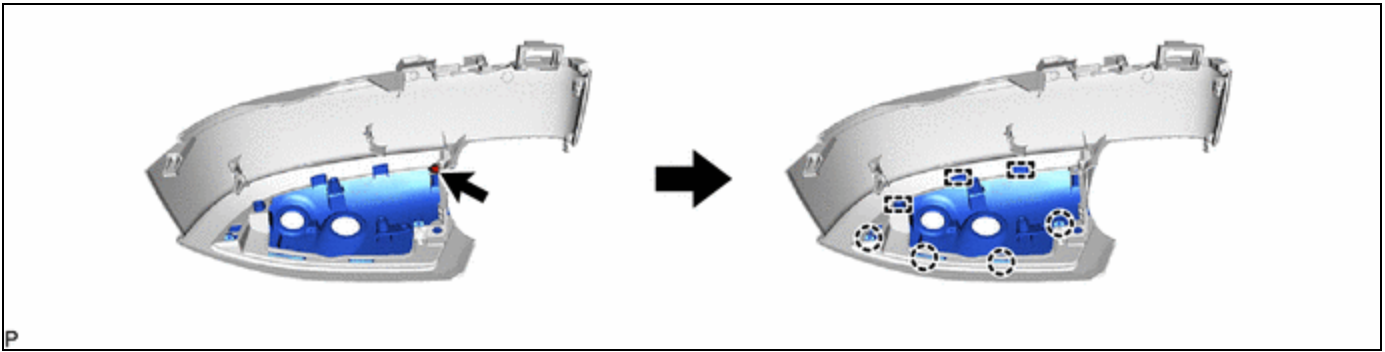

**9. REMOVE LOWER BASE COVER**



**10. REMOVE OUTER REAR VIEW MIRROR PACKING**

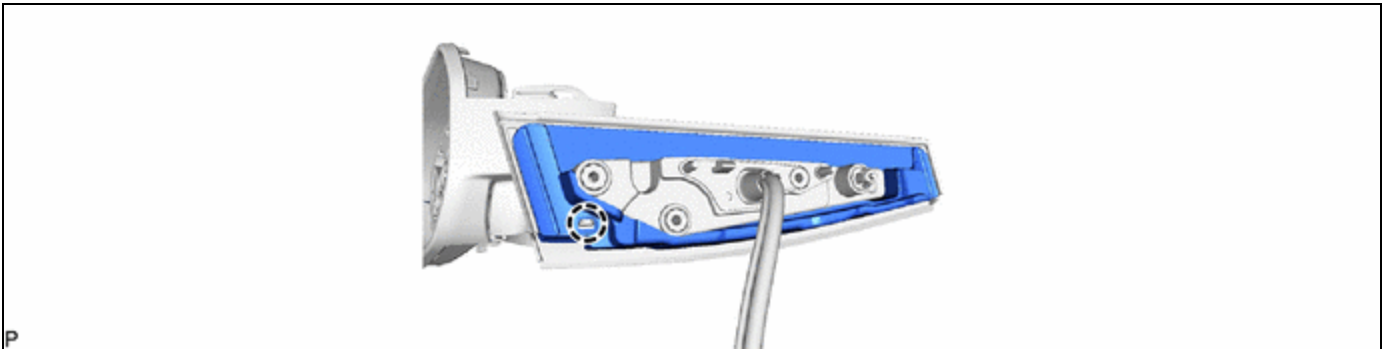

**11. REMOVE GASKET (w/ Automatic Retractable Mirror)**

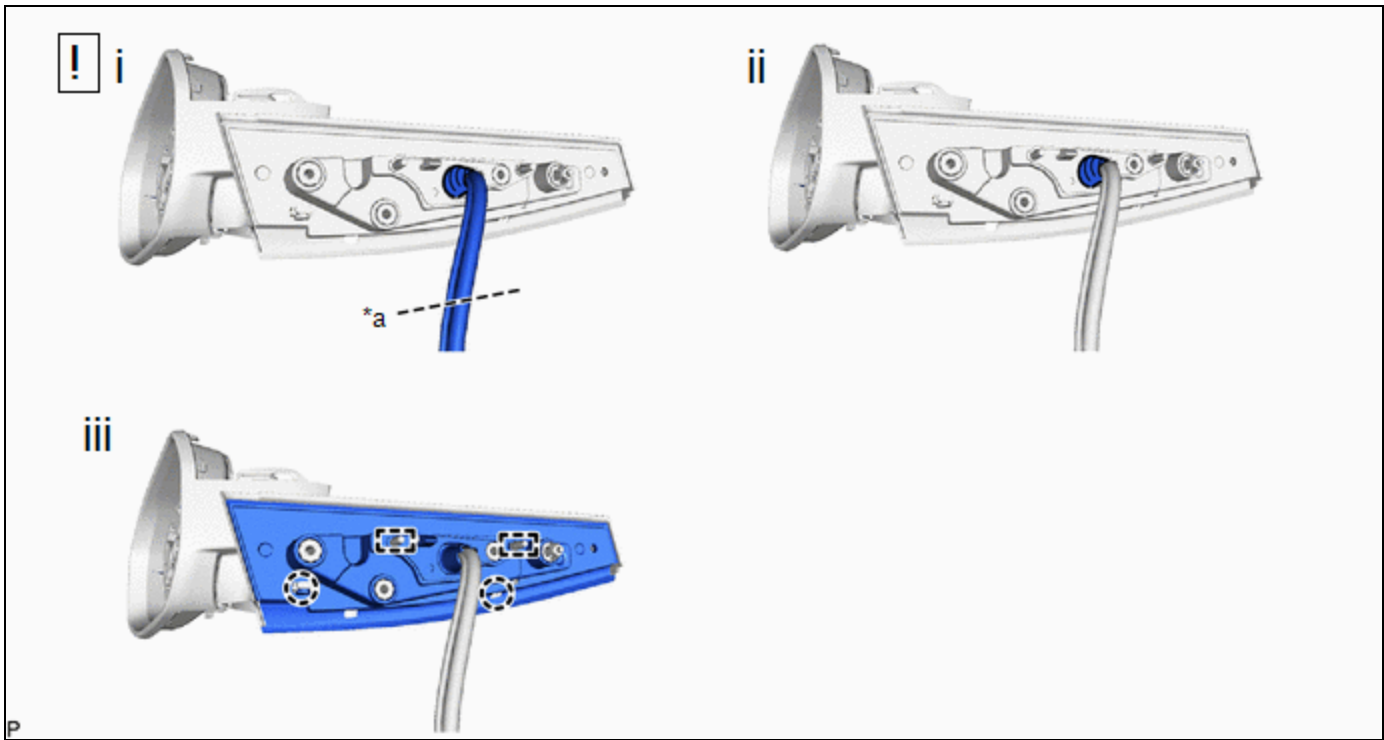

*a	Cut here	-	-
----	----------	---	---

- (1) Cut the wire harness assembly at the position shown in the illustration.
- (2) Remove the vinyl tape.
- (3) Disengage the 2 claws and 2 guides to remove the gasket.

**12. REMOVE OUTER MIRROR BASE (w/ Automatic Retractable Mirror)**

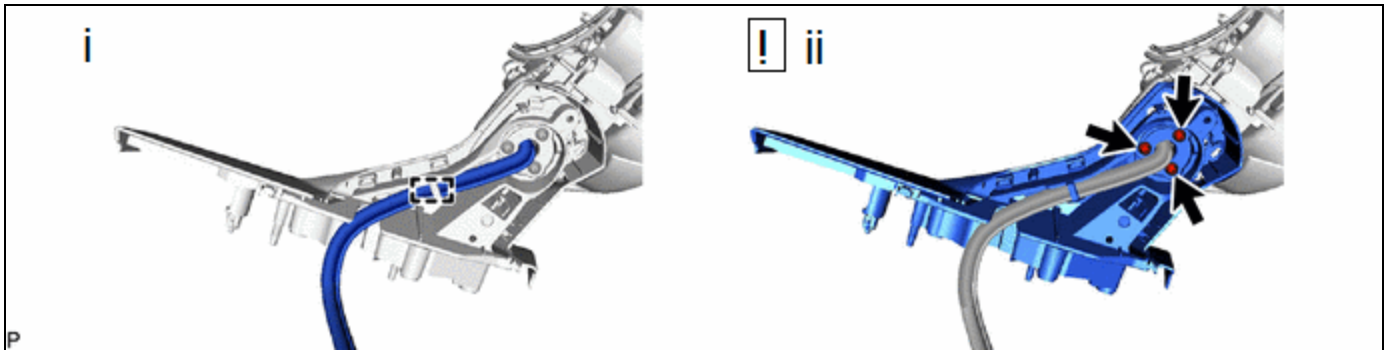

- (1) Disengage the clamp.
- (2) Using a T25 "TORX" socket wrench, remove the 3 screws and outer mirror base.

**NOTICE:**

Make sure to replace the screw with a new one.

**13. REMOVE NO. 2 OUTER MIRROR COVER (w/ Automatic Retractable Mirror)**

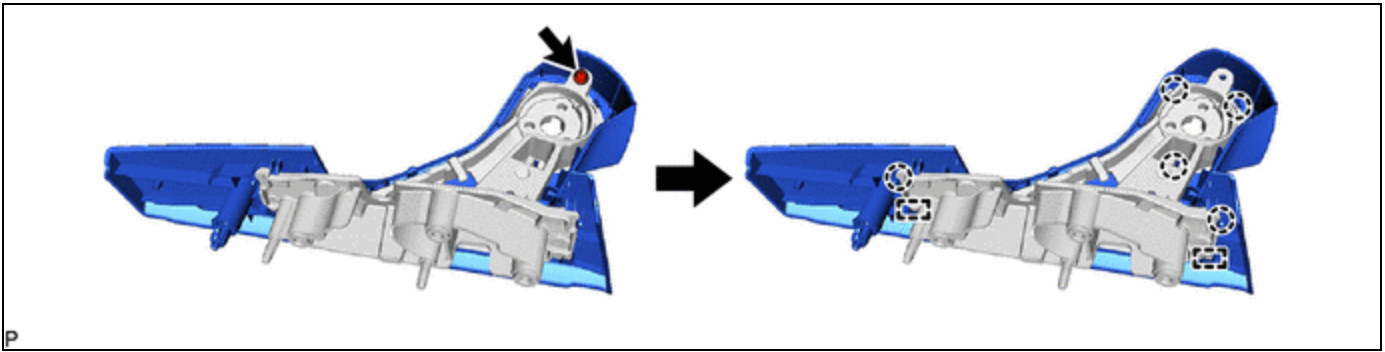

**14. REMOVE WIRE HARNESS ASSEMBLY (w/ Automatic Retractable Mirror)**

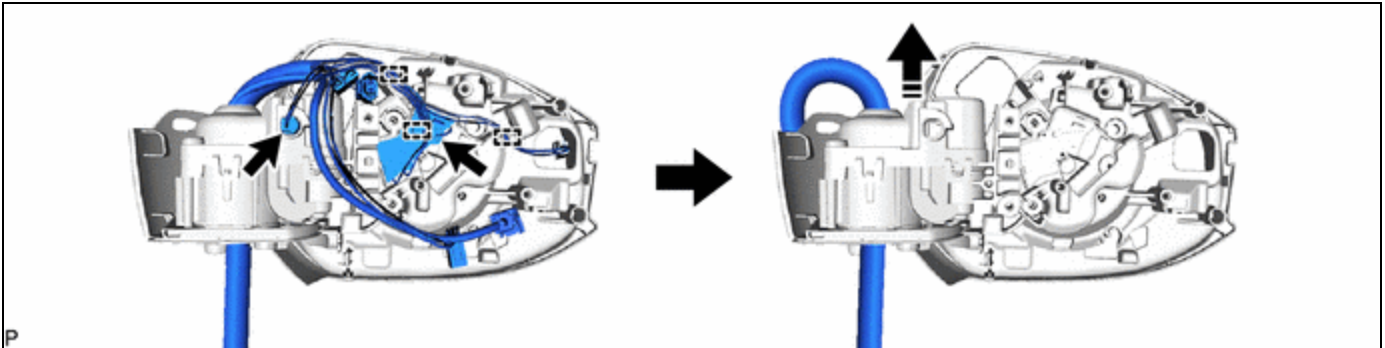

	Remove in this Direction	-	-
--	--------------------------	---	---

**15. REMOVE OUTER MIRROR RETRACTOR UNIT (w/ Automatic Retractable Mirror)**

