

6. Coolant Heat Storage System

General

- The coolant heat storage system recovers the engine coolant that has been heated by the engine and stores it in the coolant heat storage tank. Then, the system supplies the hot coolant to the engine before starting a cold engine, in order to preheat the intake port of the engine. This effectively reduces the fuel injection volume during cold starting, minimizes the adhesion of fuel onto the intake port wall surface, and reduces HC exhaust emissions.
- This system consists primarily of a coolant heat storage tank, coolant heat storage water pump, water valve, coolant heat storage tank outlet temperature sensor and ECM.

► System Diagram ◀

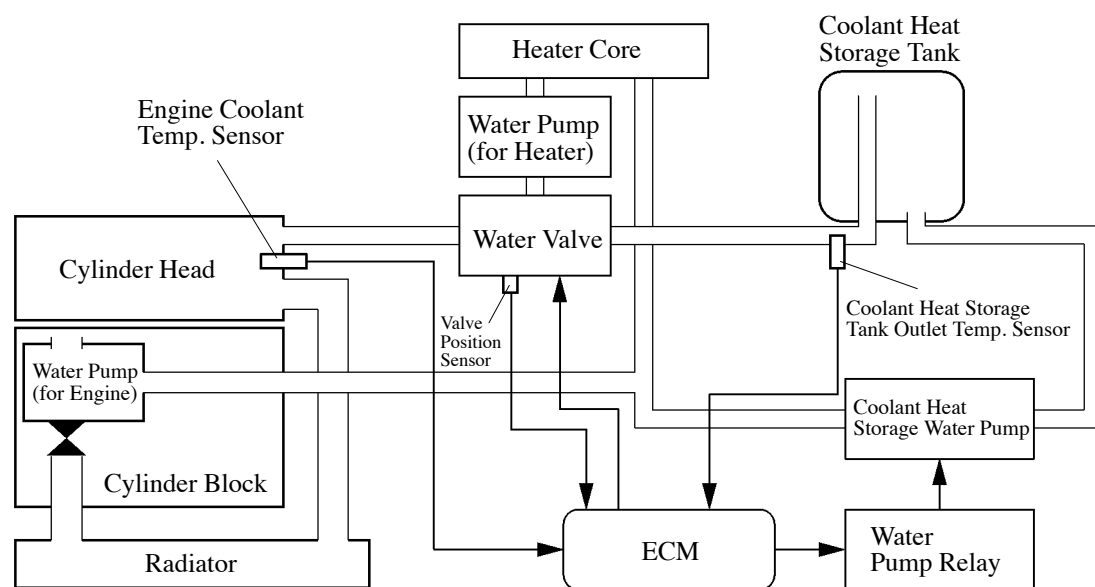

Layout of Main Components

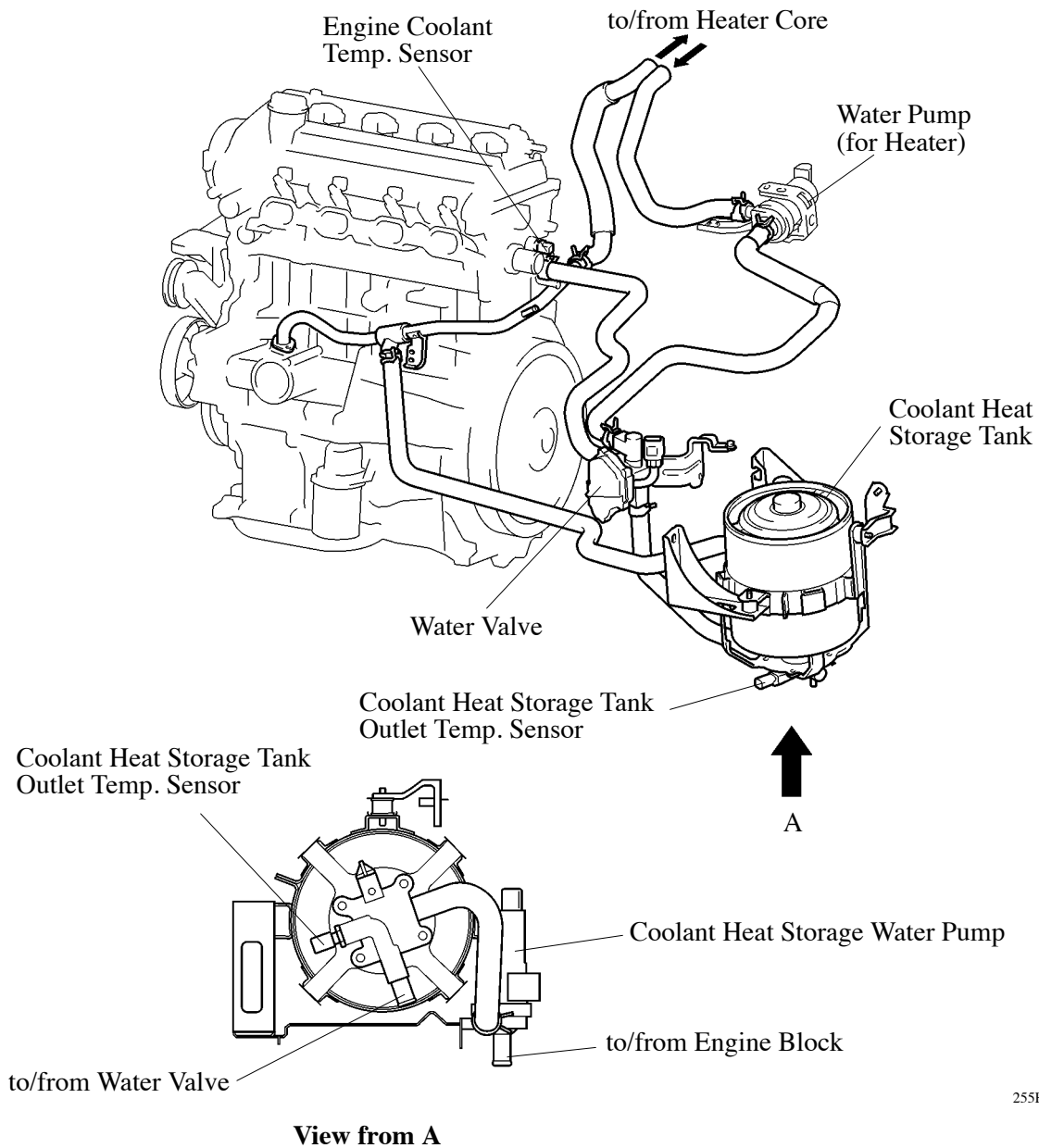

255EG08

Function of Main Components

Components	Function
Coolant Heat Storage Tank	Stores the engine coolant that has been heated by the engine, and keeps it warm.
Coolant Heat Storage Water Pump	Actuated by the ECM via a relay, this pump supplies coolant from the coolant heat storage tank to the engine and recovers coolant from the engine and stores it to the coolant heat storage tank.
Water Valve	Actuated by the ECM, this valve switches the engine coolant passages in accordance with the system control conditions.
Coolant Heat Storage Tank Outlet Temp. Sensor	Located at the engine coolant inlet/outlet of the coolant heat storage tank, this sensor transmits the engine coolant temperature measured at the inlet/outlet of the coolant heat storage tank to the ECM.
ECM	The ECM effects preheat control (to supply hot coolant to the engine) and hot coolant recovery control through the water pump and the water valve.

Construction and Operation

1) Coolant Heat Storage Tank

- The coolant heat storage tank is a heat insulation container made of stainless steel, and has a dual vacuum construction. It can store approximately 3 liters of engine coolant and keep it warm. The basic construction of this tank is the same as the household Thermos bottle.
- The bottom area of the coolant heat storage tank contains 2 water paths for the engine coolant, a coolant heat storage tank outlet temperature sensor, and a drain plug.

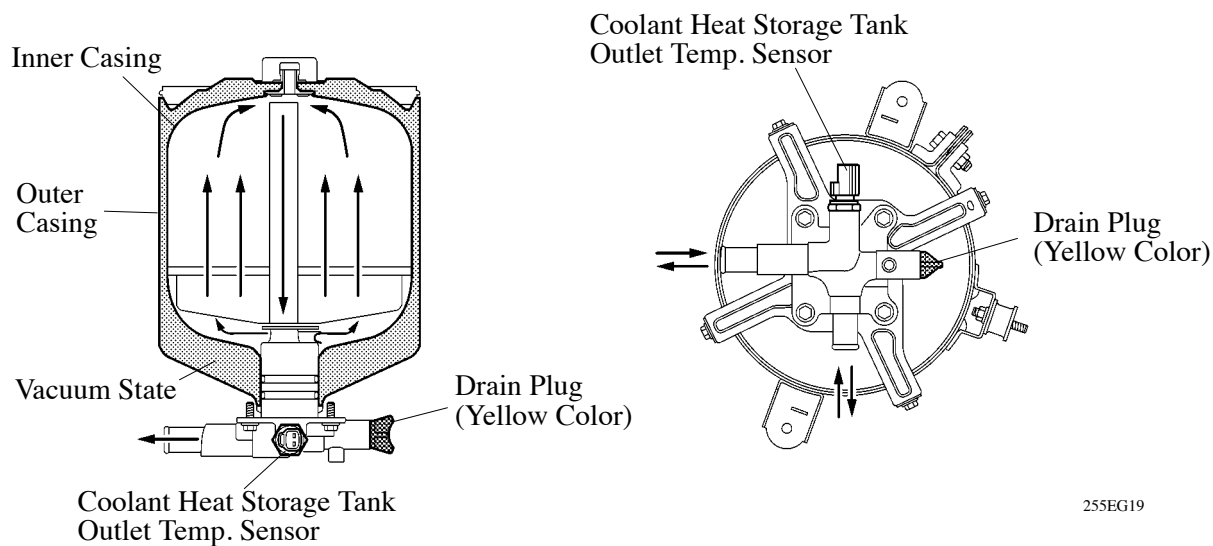

Coolant Heat Storage Tank Cross Section

View from the Bottom Side

255EG19

Service Tip

The engine coolant in the coolant heat storage tank is kept hot even if the engine and the radiator are cold. To verify the thermal insulation of the coolant heat storage tank and abnormality in the coolant heat storage water pump, the ECM may cause the coolant heat storage water pump to actuate even when the power switch is OFF (IG-OFF). Therefore, the user should never attempt to change the engine coolant. Because of the reason above, the engine coolant change method has been changed on the '04 Prius. An outline of the change as follow:

- Remove the coolant heat storage water pump connector prior to replacement, in order to prevent the pump from activating when draining the engine coolant.
- Drain the engine coolant from the coolant heat storage tank.
- When refilling engine coolant, operate the coolant heat storage water pump to help the inflow of the coolant into the coolant heat storage tank.
- Due to the aforementioned function of the ECM, the ECM may operate the coolant heat storage water pump while the engine coolant is being changed. If this occurs, the ECM will determine that a failure has occurred in the coolant heat storage system, it will record DTC P1151 or P2601 in its memory, and illuminate the MIL (Malfunction Indicator Lamp). However, this condition is not actual system fail. If the MIL has illuminated, make sure to delete the DTC after changing the engine coolant.

For detailed information of changing the engine coolant, refer to the 2004 Prius Repair Manual (Pub. No. RM1075U).

2) Coolant Heat Storage Water Pump

- This water pump contains a DC brush motor that is driven with a 12V~14V power supply.
- The ECM actuates a relay to operate the water pump in order to supply the hot coolant from the coolant heat storage tank to the engine (pre-heat operation), and recover the hot coolant to be stored in the coolant heat storage tank while the vehicle is stopped (IG-OFF).

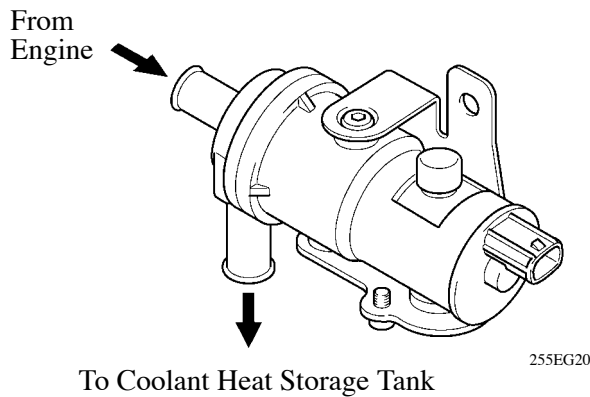

► Specifications ◀

Pump Type	Centrifugal Pump	
Motor Type	DC Brush Motor	
Flow Volume	14 V	23.5L/min
	12 V	21.0L/min
Discharge Pressure	14 V	32 kPa (4.6 psi)
	12 V	25.5 kPa (3.7 psi)

3) Water Valve

a. General

- The water valve is located in the engine coolant passage between the engine, heater core, and the coolant heat storage tank. It switches the engine coolant passages when the position of the rotary valve, which is built into the water valve, is switched.
- The water valve consists of a rotary valve, valve position sensor, reduction gear, and an electric motor.
- This sensor, which is located above the rotary valve, outputs a voltage that corresponds to the rotation of the rotary valve to the ECM.

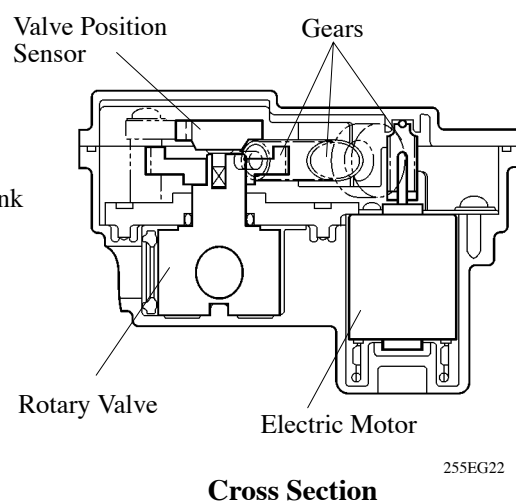
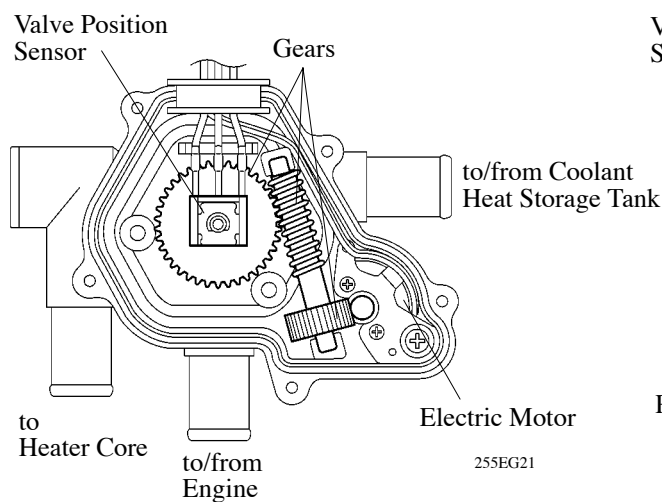

b. Rotary Valve

- The ECM determines the present position of the rotary valve in accordance with the voltage that is being output by the valve position sensor. To switch the position of the rotary valve in order to switch the engine coolant passages, the electric motor operates the rotary valve.
- The ECM switches the rotary valve to the 3 positions indicated below, in accordance with the control mode of the coolant heat storage system.

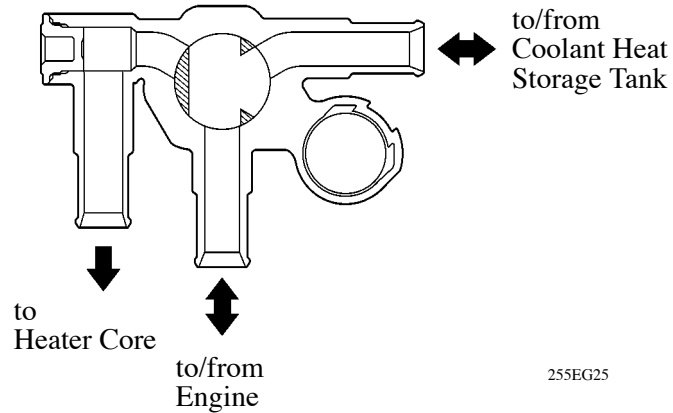

255EG25

Rotary Valve Cross Section

► Rotary Valve Position ◀

<ul style="list-style-type: none"> • Preheat Operation • Storage Operation (After Power Switch OFF) • Power Switch OFF 	<ul style="list-style-type: none"> • Storage Operation (During Driving) 	<ul style="list-style-type: none"> • No Storage Operation (Engine Running)

255EG24

System Operation

1) General

- Before starting a cold engine, the coolant heat storage system supplies the hot coolant that is stored in the coolant heat storage tank to the engine in order to preheat the cylinder head. After the engine has been warmed up, this system recovers the hot coolant from the engine.
- The ECM controls this system by performing the following functions in accordance with the timing chart described below: preheat operation, engine warm-up operation, storage operation (during driving), and storage operation (IG-OFF).
- To verify the thermal insulation of the coolant heat storage tank and abnormality in the coolant heat storage water pump, the ECM may cause the coolant heat storage water pump to actuate approximately 5 hours after the power switch has been turned OFF even when the power switch is OFF (IG-OFF).

► Timing Chart ◀

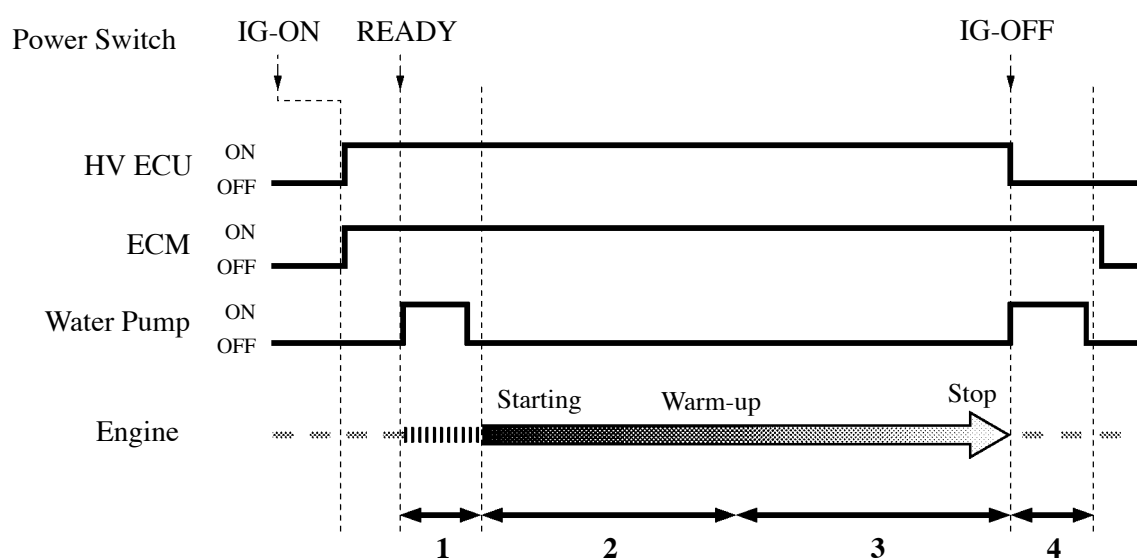

- 1: Preheat Operation
- 2: Engine Warm-Up Operation
- 3: Storage Operation (During Driving)
- 4: Storage Operation (IG-OFF)

255EG27

NOTE: After 5 hours have elapsed with the power switch OFF, the actuating sound of a motor may be heard from the engine compartment. As described previously, this is the normal actuating sound of the water pump (for the coolant heat storage system), which occurs when the ECM checks the heat storage performance of the coolant heat storage tank.

2) Preheat Operation

- Provided that the engine is cold when the hybrid system is being started, the ECM actuates the coolant heat storage water pump and operates the water valve in order to switch the engine coolant passages. Thus, the preheat operation starts, with the hot coolant stored in the coolant heat storage tank being pumped into the engine. The ECM will not perform the preheat operation if condition is other than above.
- As a rule, the engine does not operate during a preheat operation, allowing the vehicle to be driven only in the EV mode. However, preheating may be canceled and the engine may start during the preheat operation.
- The preheat operation is completed in several seconds.

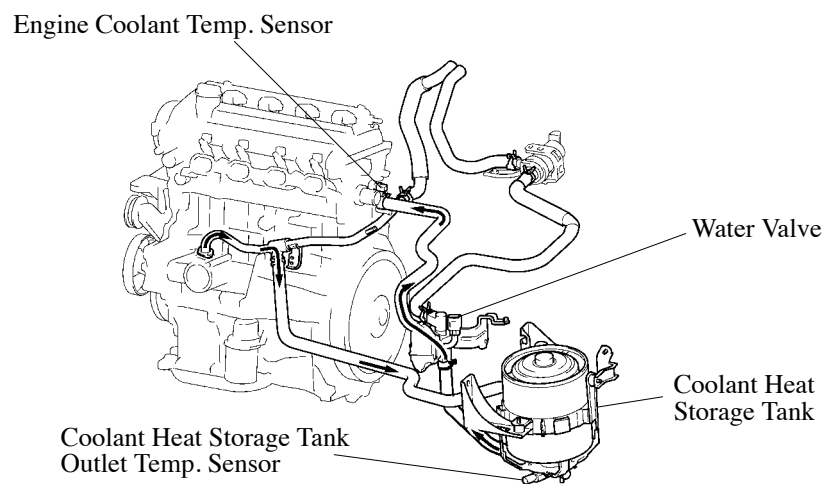

255EG28

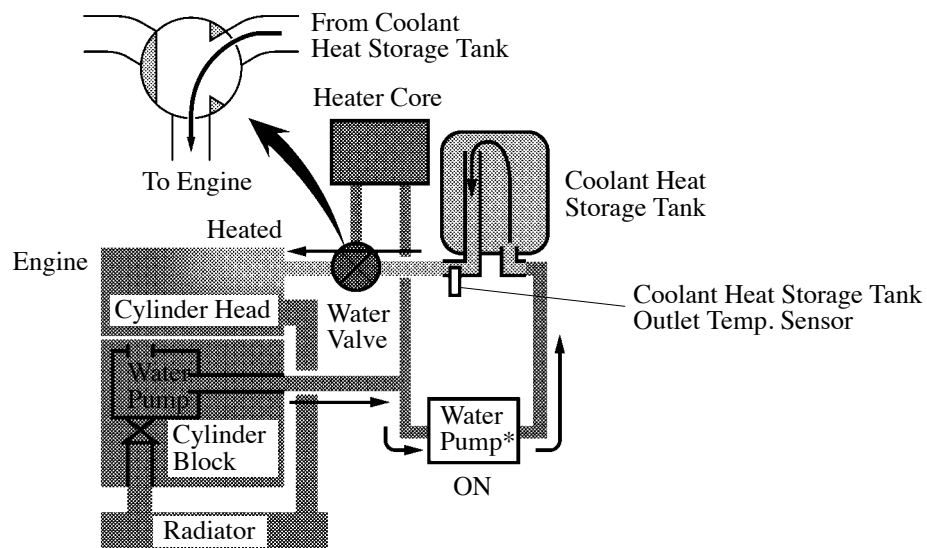

*: Coolant Heat Storage Water Pump

255EG29

3) Engine Warm-Up Operation

- After the preheat operation has been completed, the ECM stops the coolant heat storage water pump, and operates the water valve to switch the engine coolant passages, in order to stop the flow of the coolant from the coolant heat storage tank to the engine. At this time, the ECM starts the engine via the HV ECU.
- As a result, inflow of the engine coolant into the coolant heat storage tank is interrupted, and a usual engine warm-up begins.

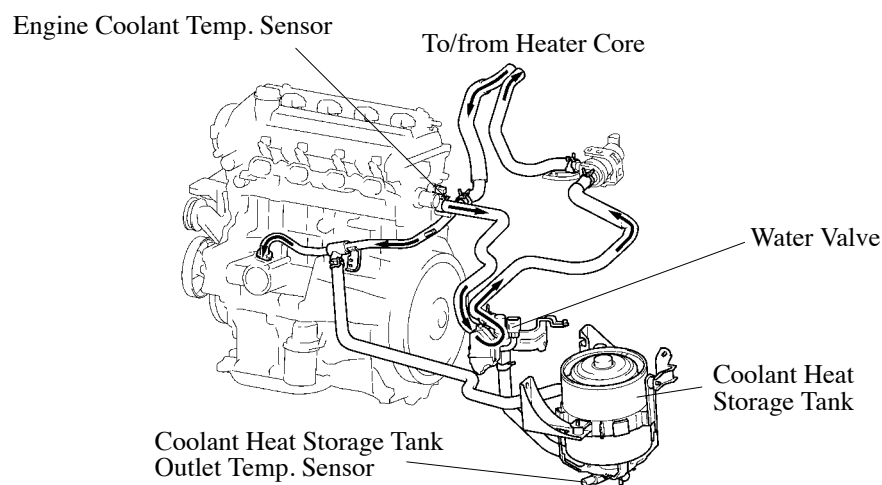

255EG30

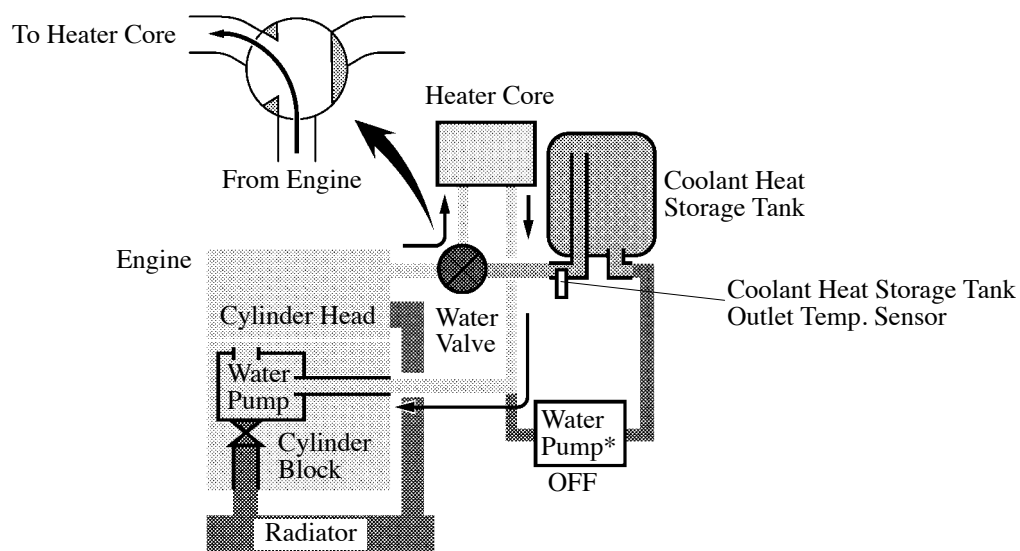

*: Coolant Heat Storage Water Pump

255EG31

4) Storage Operation (During Driving)

- After the engine warm-up has been completed, the ECM operates the water valve to switch the engine coolant passages, in order to send the hot coolant heated by the engine into the heater core (for the heater) and the coolant heat storage tank (for storing the hot coolant).
- During the storage operation, the coolant heat storage water pump is in a stop, thus the engine coolant is circulated by the mechanical water pump driven by the engine.
- Once the coolant heat storage tank is filled with hot coolant, the ECM switches the coolant passages by operating the water valve (provides the same water valve position as that of the engine warm-up operation), and stops the storage operation.

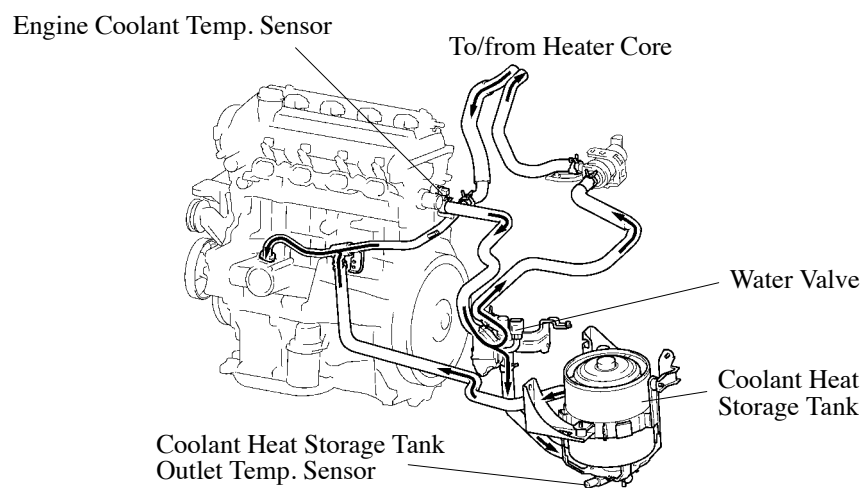

255EG32

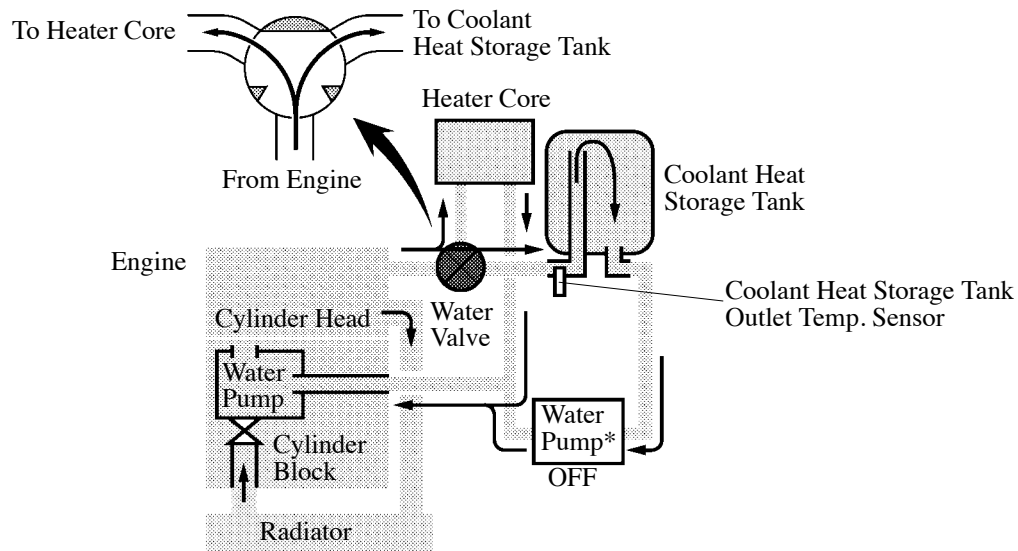

*: Coolant Heat Storage Water Pump

255EG33

5) Storage Operation (IG-OFF)

- If the power switch has been turned OFF (IG-OFF) before the recovery of the hot coolant has been completed during driving, the ECM actuates the coolant heat storage water pump and operates the water valve to switch the engine coolant passages, in order to store the hot coolant into the coolant heat storage tank. However, this operation will not be done if the engine warm-up is insufficient.
- This operation stops after it continues for several seconds.

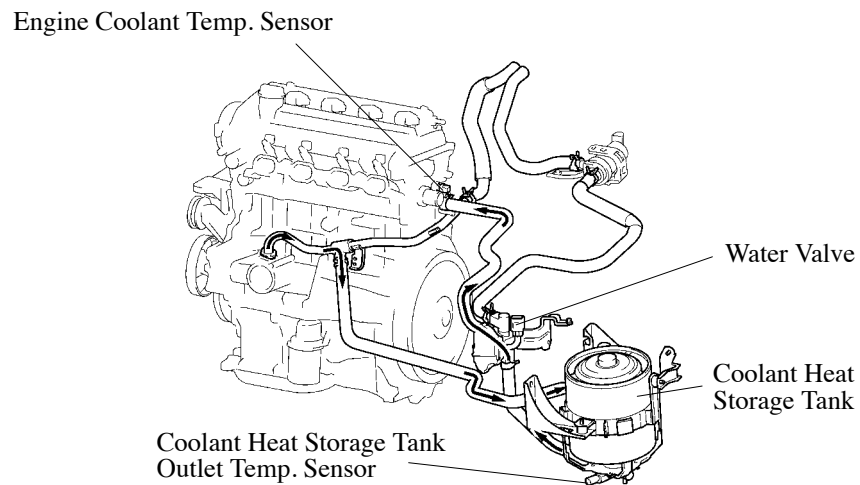

255EG34

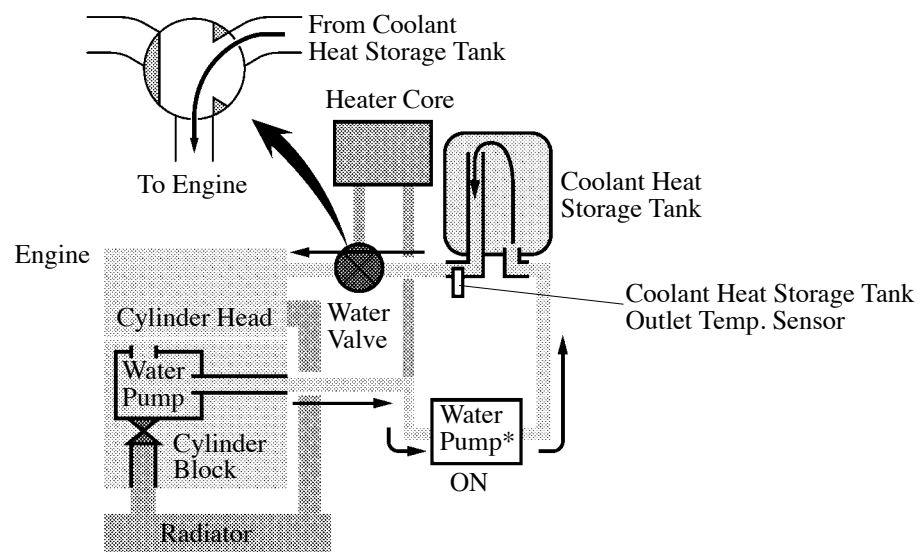

*: Coolant Heat Storage Water Pump

255EG35

7. Diagnosis

- When the ECM detects a malfunction, the ECM makes a diagnosis and memorizes the failed section. Furthermore, the MIL (Malfunction Indicator Lamp) in the combination meter illuminates or blinks to inform the driver.
- The ECM will also store the DTCs of the malfunctions.
- The diagnosis communication has been changed from serial communication (ISO9141) to CAN communication. As a result, a dedicated adapter (CAN VIM) must be attached to the conventional hand-held tester in order to read the DTCs of the ECM. For details, see the 2004 Prius Repair Manual (Pub. No. RM1075U).
- To comply with the OBD-II regulations, all the DTCs (Diagnostic Trouble Codes) have been made to correspond to the SAE controlled codes. Some of the DTCs have been further divided into smaller detection areas than in the past, and new DTCs have been assigned to them. For details, refer to the 2004 Prius Repair Manual (Pub. No. RM1075U).

Service Tip

To clear the DTC that is stored in the ECM, use a hand-held tester or disconnect the battery terminal or remove the EFI fuse for 1 minute or longer.

8. Fail-Safe

When the ECM detects a malfunction, the ECM stops or controls the engine according to the data already stored in the memory.

► Fail-Safe Chart ◀

DTC No.	Fail-Safe Operation	Fail-Safe Deactivation Conditions
P0031, P0032, P0037, P0038	The heater circuit in which the abnormality is detected is turned off	Power switch OFF
P0100, P0102, P0103	Ignition timing is calculated from engine speed and a throttle angle	“Pass” condition detected
P0110, P0112, P0113	Intake air temp. is fixed at 20°C (68°F)	“Pass” condition detected
P0115, P0117, P0118	Engine coolant temp. is fixed at 80°C (176°F)	“Pass” condition detected
P0120, P0122, P0123	Fuel cut intermittently	Power switch OFF
P0121	Fuel cut intermittently	“Pass” condition detected and power switch OFF
P0325	Max. ignition timing retardation	Power switch OFF
P0351, P0352, P0353, P0354	Fuel cut	“Pass” condition detected
P1115, P1117, P1118	Engine coolant temp. is fixed at 80°C (176°F)	“Pass” condition detected
P1120, P1122, P1123	Water valve position is fixed at position when DTC is detected	“Pass” condition detected
P2102, P2103	VTA is fixed at about 16% and fuel cut intermittently	Power switch OFF
P2119	VTA is fixed at about 16% and fuel cut intermittently	“Pass” condition detected and power switch OFF