

PRIUS *v*
2 0 1 2



QUICK REFERENCE GUIDE

2012 Prius v

This *Quick Reference Guide* is a summary of basic vehicle operations. It contains brief descriptions of fundamental operations so you can locate and use the vehicle's main equipment quickly and easily.

The *Quick Reference Guide* is not intended as a substitute for the *Owner's Manual* located in your vehicle's glove box. We strongly encourage you to review the *Owner's Manual* and supplementary manuals so you will have a better understanding of your vehicle's capabilities and limitations.

Your dealership and the entire staff of Toyota Motor Sales, U.S.A., Inc. wish you many years of satisfied driving in your new Prius v.

! A word about safe vehicle operations

This *Quick Reference Guide* is not a full description of Prius v operations. Every Prius v owner should review the *Owner's Manual* that accompanies this vehicle.

Pay special attention to the boxed information highlighted in color throughout the *Owner's Manual*. Each box contains safe operating instructions to help you avoid injury or equipment malfunction.

All information in this *Quick Reference Guide* is current at the time of printing. Toyota reserves the right to make changes at any time without notice.

INDEX

OVERVIEW	Engine maintenance	9
	Fuel tank door release and cap	8
	Hood release	8
	Indicator symbols	4-5
	Instrument cluster	4
	Instrument panel	2-3
	Keyless entry¹	6
	Light control-Instrument panel	9
Smart Key system¹	7	
FEATURES/OPERATIONS	Air Conditioning/Heating	17
	Audio	18
	Auto lock/unlock¹	10
	Clock	23
	Cruise control	20
	Dynamic Radar Cruise Control	21
	EV drive mode	12
	Garage door opener (HomeLink®) ²	23
	Hill-start Assist Control (HAC)	23
	Hybrid Synergy Drive System	10
	Lights¹ & turn signals	15
	Panoramic roof shades ¹	19
	Parking brake	12
	Power outlets	20
	Seat adjustments-Front	13
	Seat heaters	16
	Seat-Folding down rear seat	14
	Seats-Flattening front seatbacks	13
	Seats-Head restraints	13
	Steering wheel switches	19
	Telephone controls (Bluetooth®)	22
	Tilt and telescopic steering wheel	12
	Transmission	11
	Trip information display	22
	Windows-Power	16
	Windshield wipers & washers	14
SAFETY AND EMERGENCY FEATURES	Doors-Child safety locks	25
	Door locks	25
	Floor mat installation	27
	Seat belts	24
	Seat belts-Shoulder belt anchor	24
	Spare tire & tools	25
	Star Safety System™	26-27
	Tire Pressure Monitoring (warning) System	24

¹ Visit your Toyota dealer for information on customizing this feature.

² HomeLink® is a registered trademark of Johnson Controls, Inc.

OVERVIEW

Instrument panel

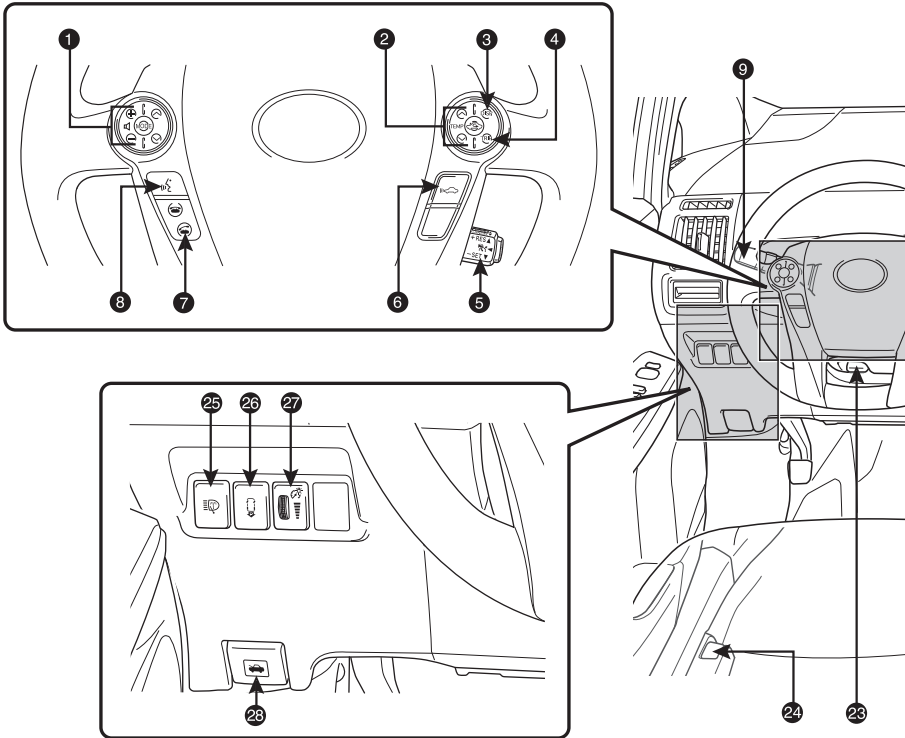

- 1 Steering wheel audio controls
- 2 Steering wheel climate controls
- 3 Trip information display button
- 4 "TRIP" button
- 5 Cruise control
- 6 Radar cruise control distance switch¹
- 7 Telephone controls²
- 8 Voice command button^{1,2}
- 9 Headlight and turn signal controls/Headlight, turn signal and front fog light controls¹
- 10 Wiper and washer controls
- 11 Trip information display
- 12 Audio system or navigation system-integrated audio system^{1,2}
- 13 Mph or km/h button
- 14 Emergency flasher button
- 15 Power button
- 16 "P" position switch
- 17 Shift lever

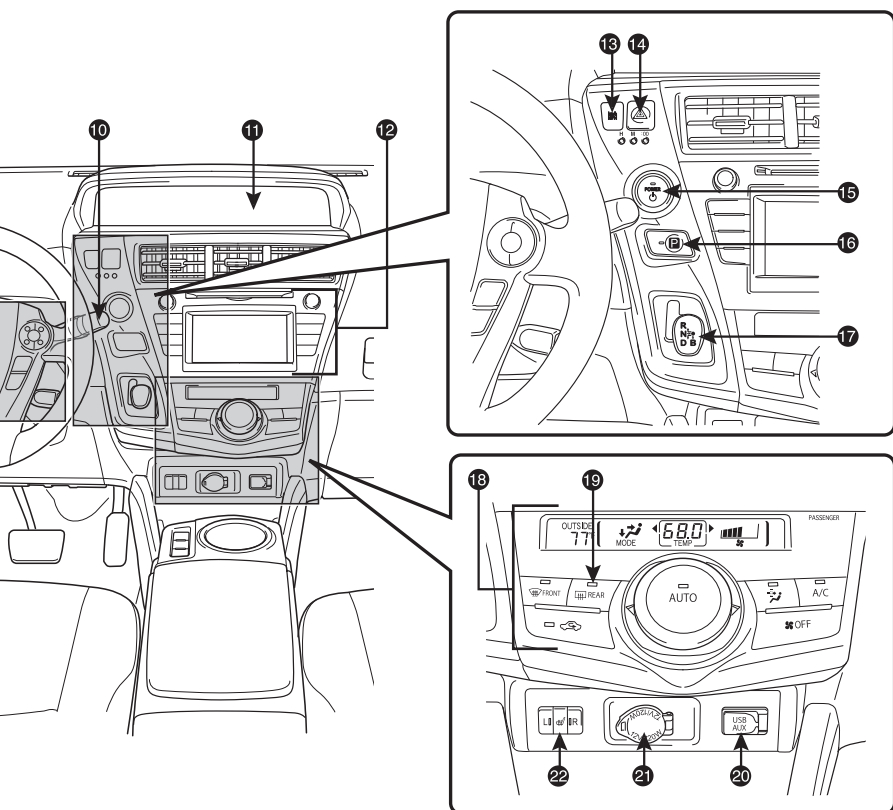

- 18 Air Conditioning controls
- 19 Outside rearview mirror/Rear window defogger button
- 20 AUX port/USB port
- 21 Power outlet
- 22 Seat heater switches¹
- 23 Tilt and telescopic steering lock release lever
- 24 Fuel filler door opener
- 25 Headlight cleaner switch¹
- 26 Advanced Parking Guidance System switch^{1,2}
- 27 Instrument panel light control
- 28 Hood lock release lever

¹ If equipped

² For vehicles with a display audio or navigation system, refer to the “Display Audio Owner’s Manual” or “Navigation System Owner’s Manual.”

NOTE: For vehicles equipped with Entune™, please consult the “Navigation System With Entune Quick Reference Guide” or www.toyota.com/entune.



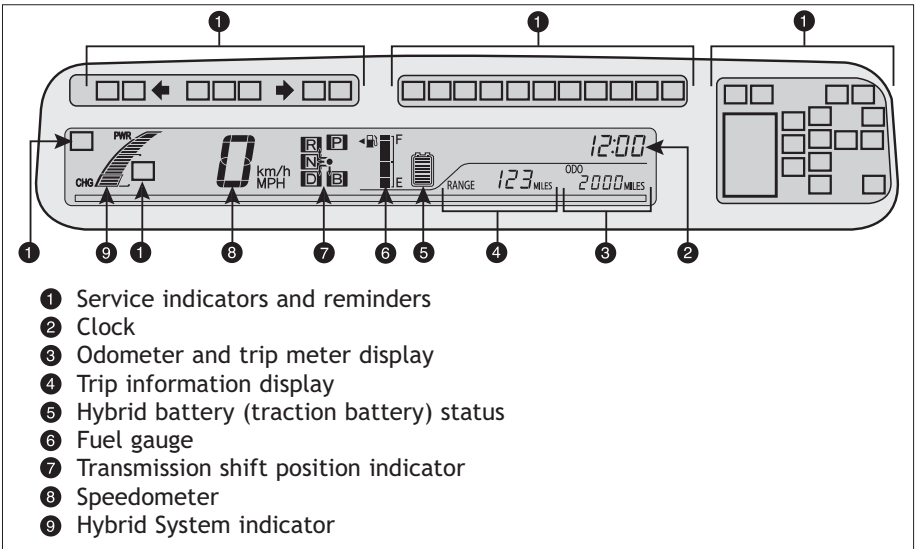







Instrument cluster





























- 1 Service indicators and reminders
- 2 Clock
- 3 Odometer and trip meter display
- 4 Trip information display
- 5 Hybrid battery (traction battery) status
- 6 Fuel gauge
- 7 Transmission shift position indicator
- 8 Speedometer
- 9 Hybrid System indicator

Indicator symbols

For details, refer to “Indicators and warning lights,” Section 2-2, *2012 Owner’s Manual*.

-  BRAKE Brake system warning¹
-  Brake system warning light (yellow indicator)¹
-  Driver seat belt reminder and/or front passenger seat belt reminder (alarm will sound if speed is over 12 mph)
-  Charging system warning¹
-  Front passenger occupant classification or front passenger airbag ON/OFF indicator
-  Malfunction/Check Engine indicator¹
-  Low fuel level warning
-  Open door warning
-  Airbag SRS warning¹
-  Low Tire Pressure Warning¹
-  Electric power steering system warning¹

¹ If indicator does not turn off within a few seconds of starting hybrid system, there may be a malfunction. Have vehicle inspected by your Toyota dealer.

		Headlight low/high beam indicators
		Turn signal indicator
		READY indicator
		Eco driving indicator ¹
		EV indicator
		EV drive mode indicator
		Eco Mode indicator
		Power Mode indicator
		Front fog light indicator
		Slip indicator/Hill-start Assist Control indicator ¹
		Cruise control indicators ²
		Anti-lock Brake System warning ¹
		Automatic headlight leveling system warning ¹
		Pre-Collision System warning light ¹
		High coolant temperature warning light ¹
		Low engine oil pressure warning ¹
		Hybrid System warning ¹
		Parking lock system warning ¹
		LED headlight warning ¹
		P position request indicator ¹
		Hybrid System overheat warning ¹
		Low Hybrid battery (traction battery) warning
		Smart Key system warning
		Maintenance required reminder ¹
		Parking lock system warning message

² If this light flashes, refer to “Cruise control,” Section 2-4, 2012 Owner’s Manual.

Keyless entry

Locking operation



Push 

Unlocking operation

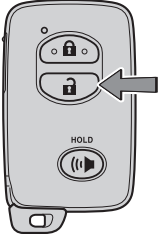

Push ONCE: Driver door
TWICE: All doors 

NOTE: If a door is not opened within 60 seconds of unlocking, all doors will relock for safety.

Panic button



Push and hold 

Smart Key system

Start function

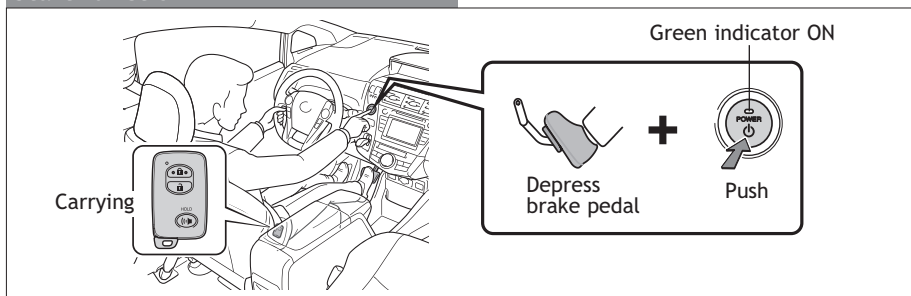

Power (without starting Hybrid System)

Without depressing the brake pedal, pressing the “POWER” switch will change the operation mode in succession from:

ACCESSORY

Accessories such as the radio will operate.

ON

Power ON; Hybrid System is not engaged.

OFF

All systems OFF.

Locking operation

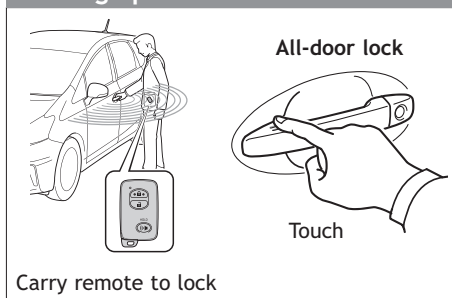

Unlocking operation

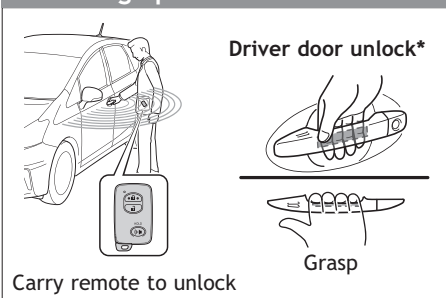

Back door lock/unlock

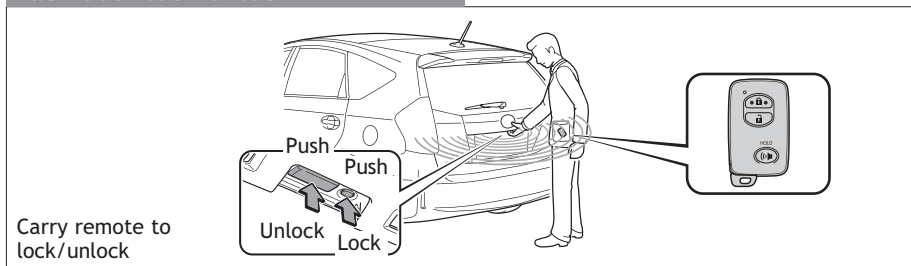

* Driver door unlocking function can be programmed to unlock driver door only, or all doors. Grasping passenger door handle or rear hatch will unlock all doors.

NOTE: Doors may also be locked/unlocked using remote.

Fuel tank door release and cap

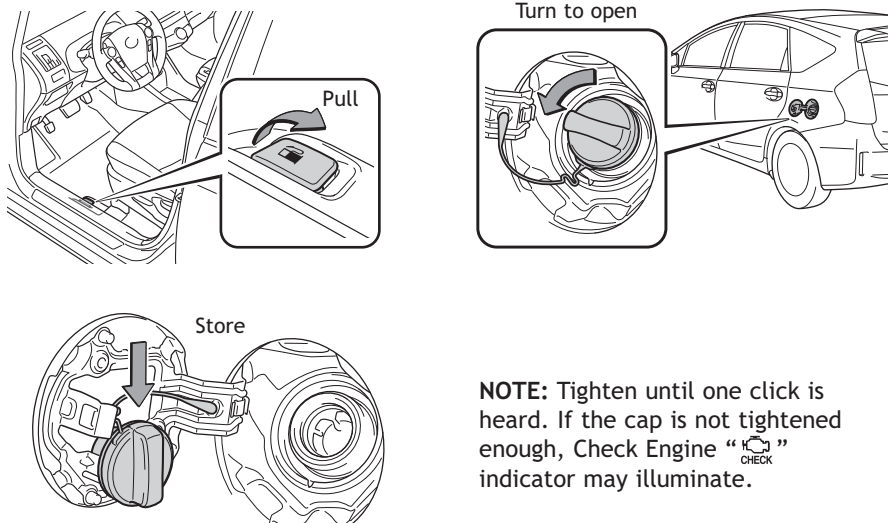

The diagram illustrates the steps to open the fuel tank door. It starts with an interior view of the driver's footwell area where a release button is located. An inset shows the button being pulled. This leads to an exterior view of the rear of the car where the fuel door is shown popping open. A close-up of the door shows it being turned to the open position. Finally, the fuel cap is shown being inserted into the door and pushed down until it clicks.

Pull

Turn to open

Store

NOTE: Tighten until one click is heard. If the cap is not tightened enough, Check Engine “” indicator may illuminate.

Hood release

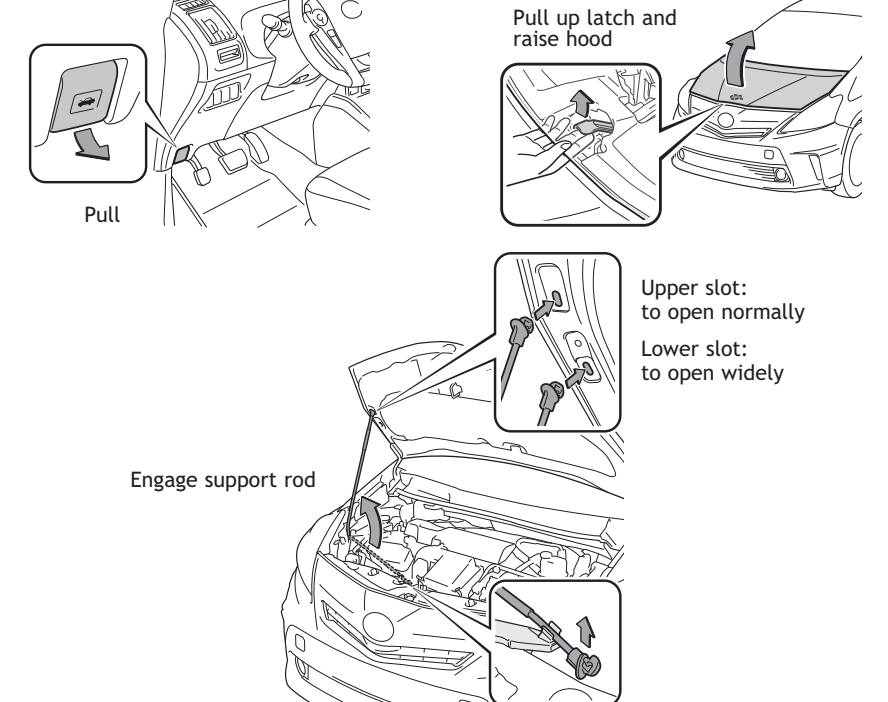

The diagram shows the steps to open the hood. It begins with an interior view of the driver's side where the hood release button is located. An inset shows the button being pulled. This leads to an exterior view of the front of the car where the hood is shown popping up. A close-up of the hood latch shows it being pulled up. The hood is then shown fully open, and an inset shows the support rod being engaged. A final inset shows the support rod being fully extended to hold the hood open.

Pull

Pull up latch and raise hood

Engage support rod

Upper slot:
to open normally

Lower slot:
to open widely

Light control-Instrument panel

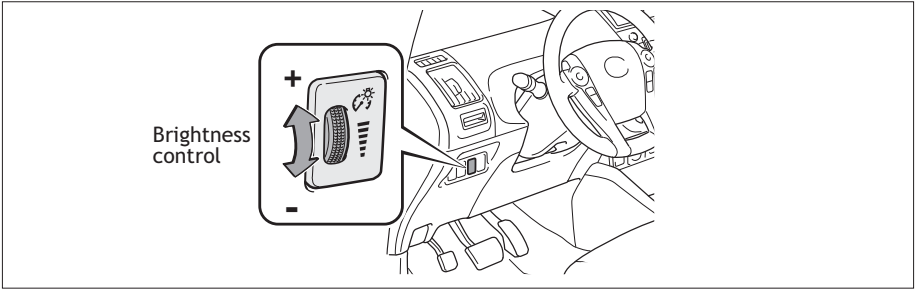

Engine maintenance

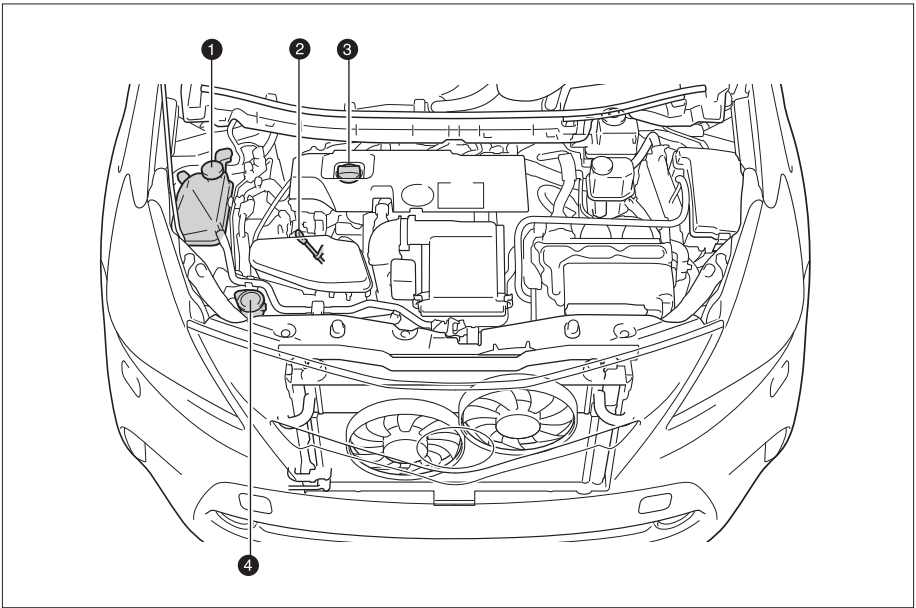

- 1 Engine coolant reservoir
- 2 Engine oil level dipstick
- 3 Engine oil filler cap
- 4 Windshield washer fluid tank

NOTE: Regularly scheduled maintenance, including oil changes, will help extend the life of your vehicle and maintain performance. Please refer to the “Warranty Maintenance Guide.”

FEATURES/OPERATIONS

Hybrid Synergy Drive System

The Hybrid Synergy Drive System utilizes a computer-controlled gasoline engine and electric motor to provide the most efficient combination of power for the vehicle. To conserve energy, when the brakes are applied the braking force generates electricity which is then sent to the traction battery. In addition, the engine shuts off when the vehicle is stopped. The benefits are better fuel economy, reduced vehicle emissions and improved performance.

NOTE: Fuel consumption and energy information of the Hybrid System are shown on the Display Audio system screen or the navigation system screen.

Tips for improved fuel economy

- Ensure tire pressures are maintained at levels specified in the *Owner's Manual*.
- When possible, link trips to reduce engine cold starts.
- Avoid driving at speeds that are higher than necessary, especially on the highway.
- When possible, avoid sudden stops to maximize regenerative braking energy.
- Minimize use of the Air Conditioning.

Starting the Hybrid System



- (1) Depress the brake pedal, and press the "POWER" switch briefly and firmly.
- (2) The "READY" light will blink. After a few seconds, when the light remains steady and a beep sounds, you may begin driving.

Auto lock/unlock

Automatic door locks can be programmed to operate in two different modes, or turned OFF.

- Doors lock when shifting from Park.
- Doors lock when the vehicle speed is approximately 12 mph or higher.
- Doors unlock when shifting into Park.
- Doors unlock when the driver's door is opened within 10 seconds after turning the "POWER" switch OFF.

Refer to the *Owner's Manual* for more details.

Transmission

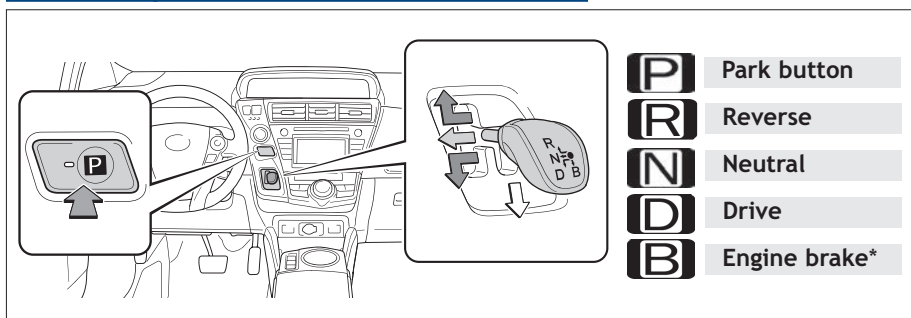

* The engine brake is the equivalent of downshifting. Shift to “B” when engine braking is desired (i.e. downhill driving, coasting to a stop, etc.).

Eco Mode

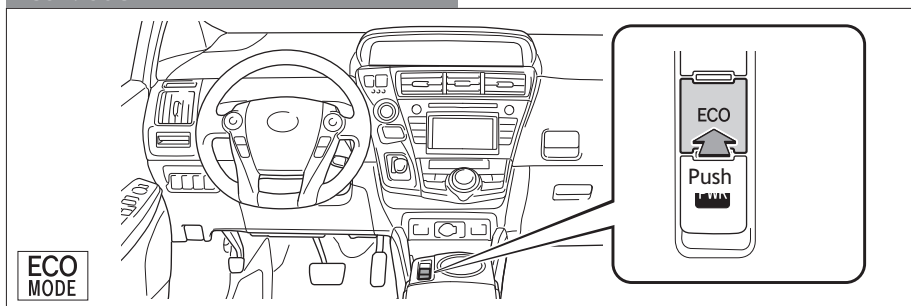

Eco Mode helps achieve low fuel consumption during trips that involve frequent accelerating and braking.

Refer to the *Owner's Manual* for more details.

Power Mode

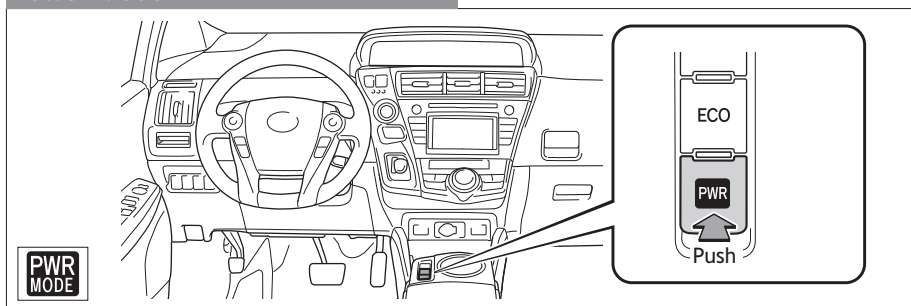

Use when a higher level of response is desired, such as when driving in mountainous regions.

Refer to the *Owner's Manual* for more details.

EV drive mode

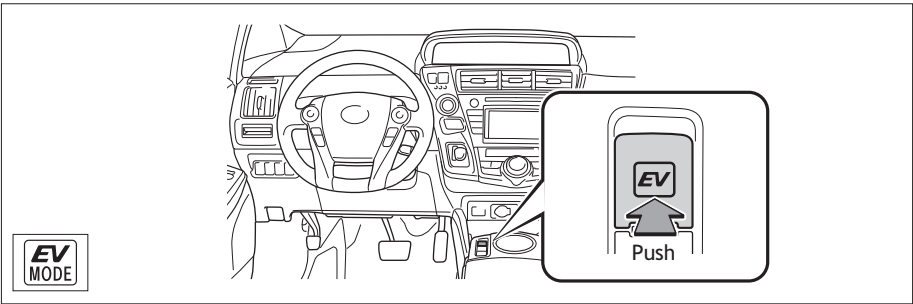

EV drive mode allows the electric motor (traction motor), powered by the hybrid battery (traction battery), to be used to drive the vehicle under certain driving conditions.

Refer to the *Owner's Manual* for more details.

Tilt and telescopic steering wheel

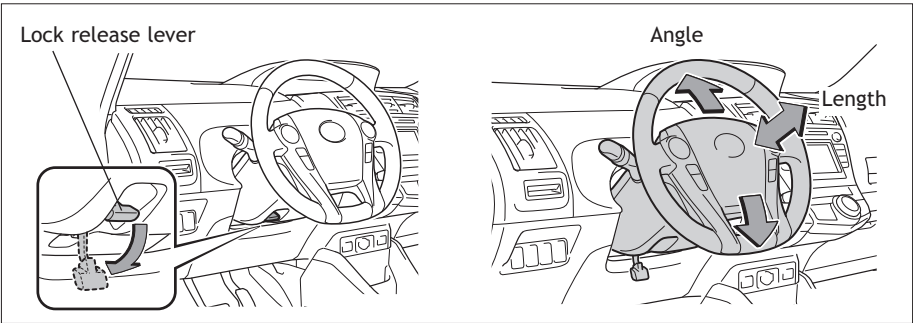

Hold wheel, push lever down, set angle and length, and return lever.

NOTE: Do not attempt to adjust while the vehicle is in motion.

Parking brake

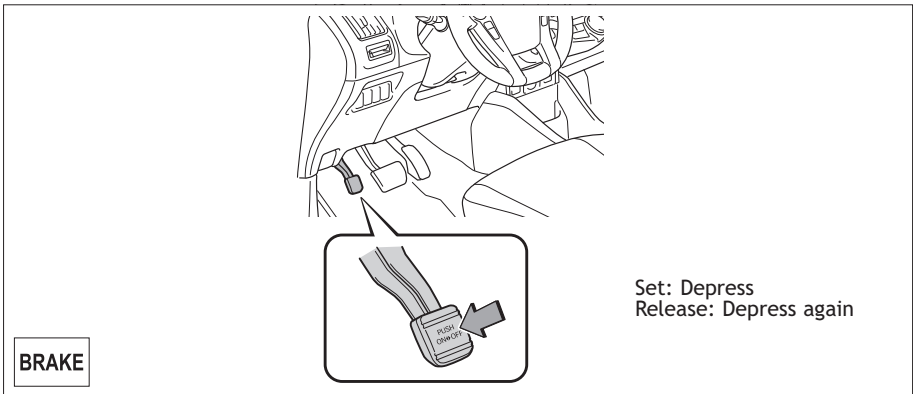

Set: Depress
Release: Depress again

Seat adjustments-Front

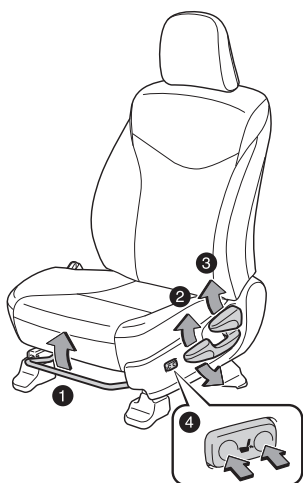

- ① Seat position (forward/backward)
- ② Height crank (driver side)
- ③ Seatback angle
- ④ Lumbar support (driver side)

Seats-Head restraints

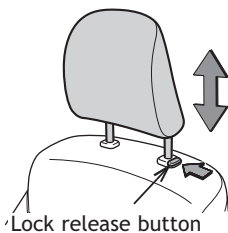

Seats-Flattening front seatbacks

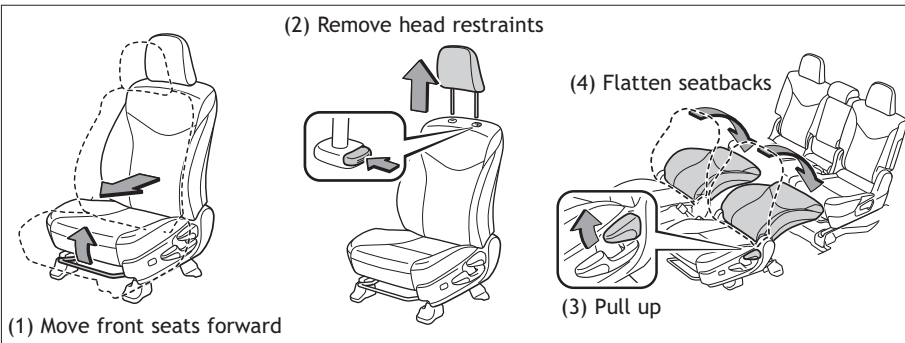

Seat-Folding down rear seat

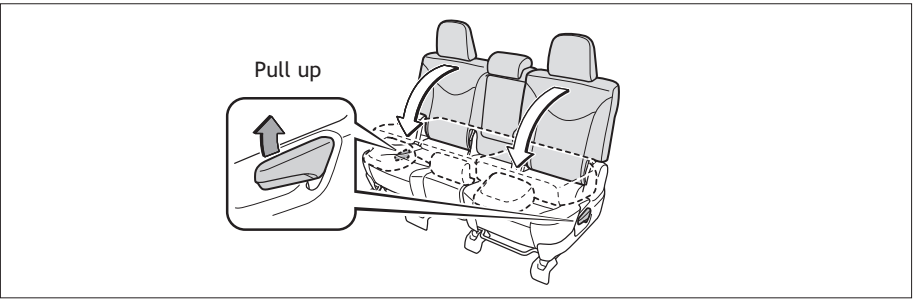

Windshield wipers & washers

Front

Type A

Single wipe ↑
 Interval wipe ↓
 Slow ↓
 Fast ↓
 Pull to wash and wipe ↓

Intermittent windshield wiper frequency

Increase ↑
 Decrease ↓

Type B

Single wipe ↑
 Interval wipe ↓
 Slow ↓
 Fast ↓
 Pull to wash and wipe ↓

Intermittent windshield wiper frequency

Increase ↑
 Decrease ↓

Rear

Type A

1 Wash and wipe ↑
 2 Wipe ↑
 3 Interval wipe ↑
 4 Wash and wipe ↑

Type B

1 Wash and wipe ↑
 2 Wipe ↑
 3 Interval wipe ↑
 4 Wash and wipe ↑

Lights & turn signals

Headlights

Type A

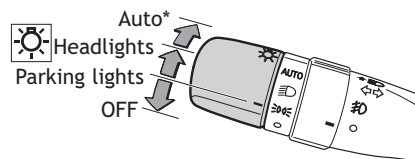

Type B

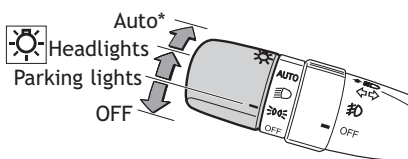

Type C

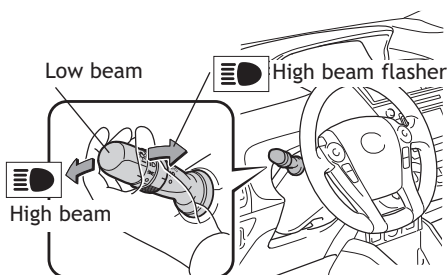
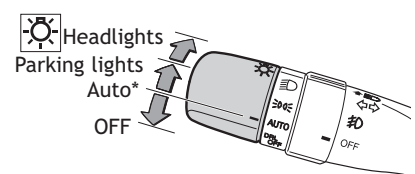

* If equipped

Automatic light cutoff system Automatically turns lights off after a delay of 30 seconds.

Front fog lights (if equipped)

Type A

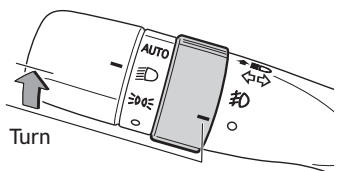

Type B

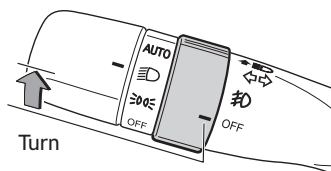

 Front fog lights come on only when the headlights are on low beam.

Turn signals

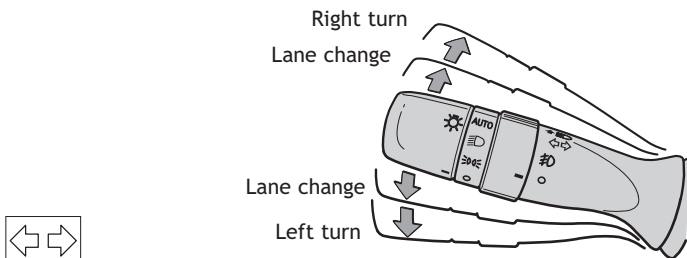

Windows-Power

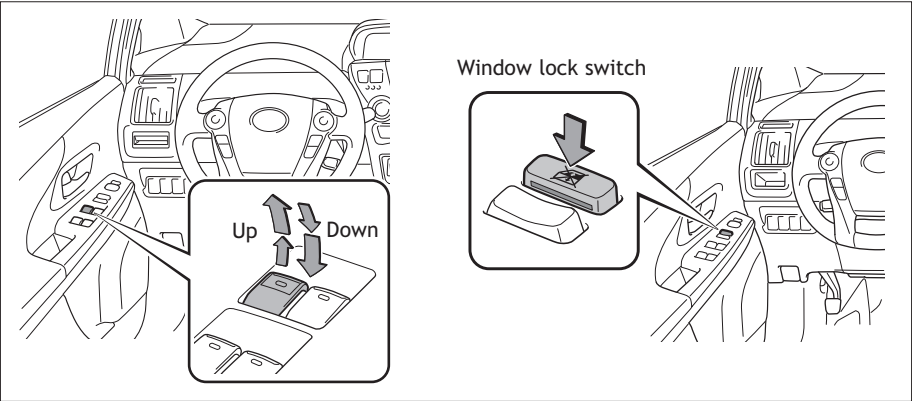

Automatic operation Push the switch completely down or pull it completely up and release to fully open or close. To stop window midway, push the switch in the opposite direction.

Window lock switch Deactivates all passenger windows. Driver's window remains operable.

Seat heaters (if equipped)

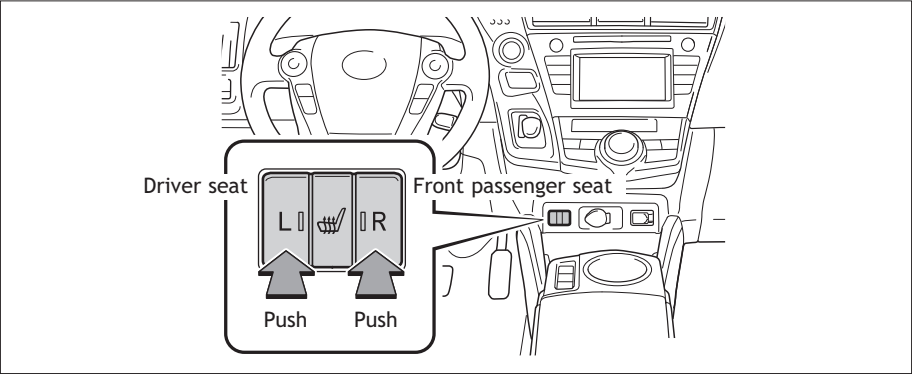

Air Conditioning/Heating

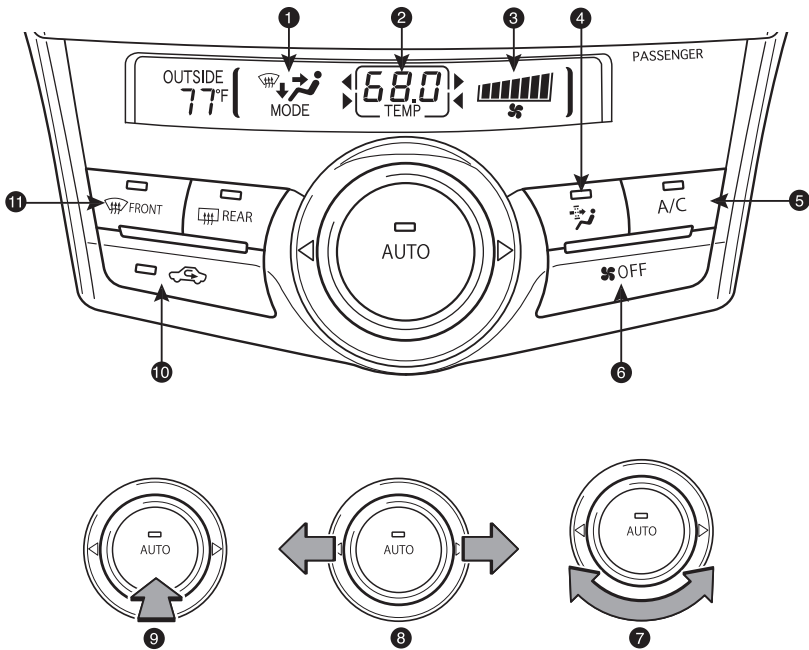

- ❶ Air outlet display
- ❷ Temperature setting display
- ❸ Fan speed display
- ❹ Micro dust and pollen filter mode (turns off automatically after 3 minutes)
- ❺ Air Conditioning ON/OFF
- ❻ Climate control OFF
- ❼ Adjust/select
- ❽ Function select
- Slide the dial left and right to select the function:
 - Fan speed control
 - Temperature selector
 - Airflow vent
- Use “” or “” mode to reduce window fogging (system automatically switches to fresh air mode).
- ❾ Automatic climate control ON
Adjusting the temperature setting will cause the airflow vents, air intake and fan to adjust automatically.
- ❿ Recirculate cabin air (fresh air when OFF)
- ⓫ Windshield defogger

Audio (if equipped)

Refer to the “Display Audio System Owner’s Manual” for instructions and more information.

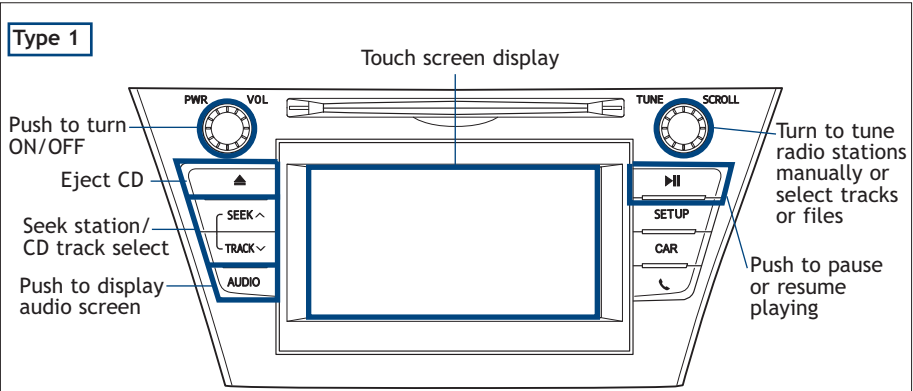

Type 2 (additional function)

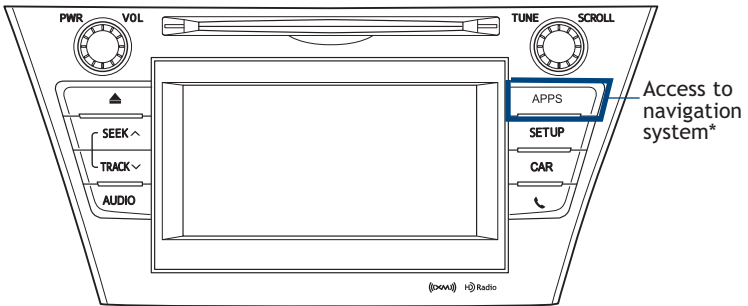

* Refer to the “Navigation System With Entune Quick Reference Guide.”

USB/AUX port

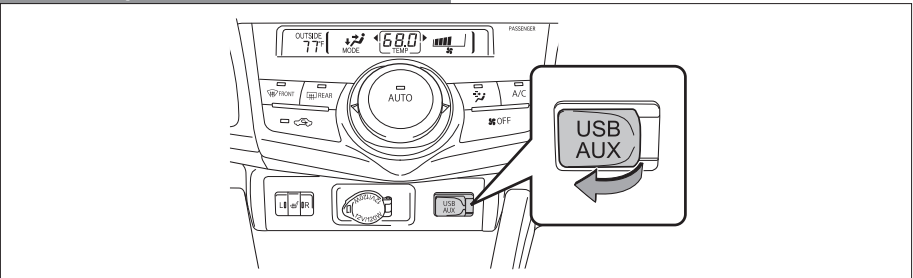

By inserting a mini plug into the USB/AUX port, you can listen to music from a portable audio device through the vehicle’s speaker system while in USB/AUX mode.

Refer to the “Display Audio System Owner’s Manual” for instructions and more information.

Steering wheel switches

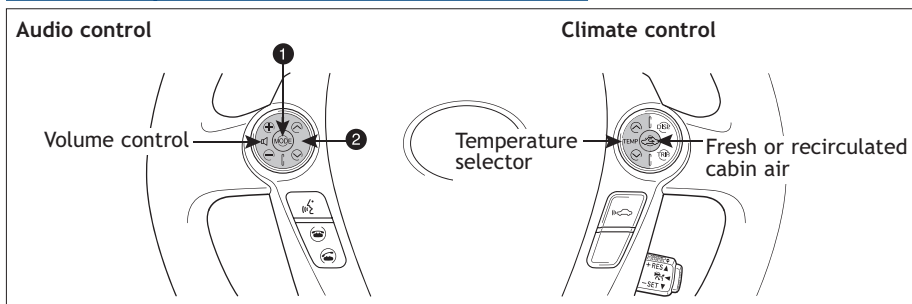

1 "MODE"

Push to turn audio ON and select an audio mode. Push and hold to turn the audio system OFF.

2 "V Λ"

Use to search within the selected audio medium (radio, CD, iPod®, etc.).

Panoramic roof shades (if equipped)

Opening operation

Push once to open. To stop partway, press the switch lightly.

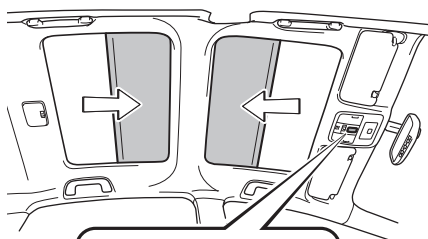

Closing operation

Push once to close. To stop partway, press the switch lightly.

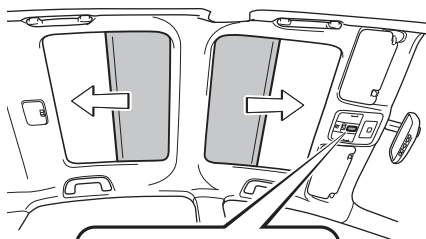

Power outlets

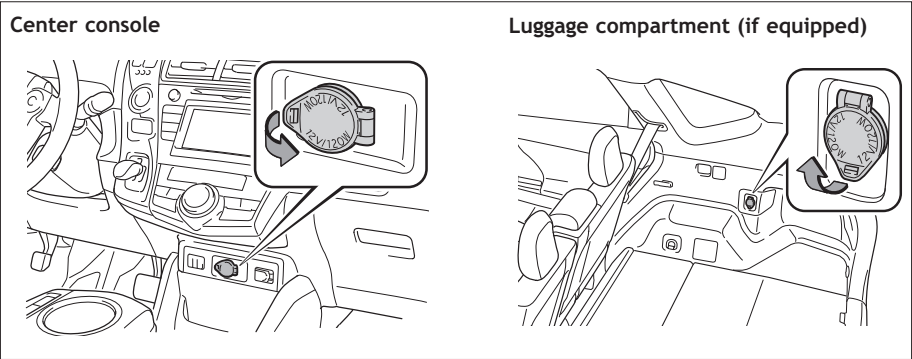

Power switch must be set at “ACCESSORY” or “ON” mode to be used.

Cruise control (if equipped)

Turning system ON/OFF

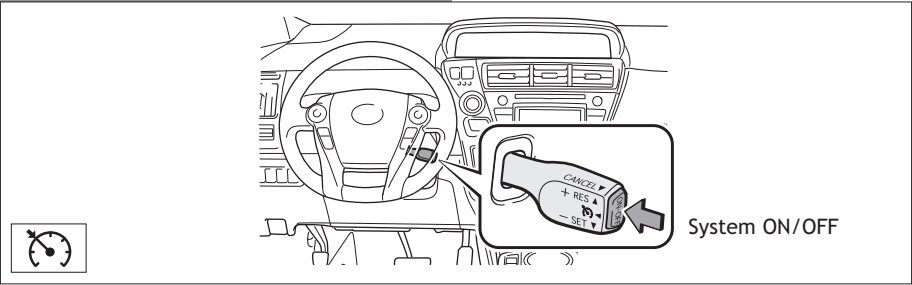

Functions

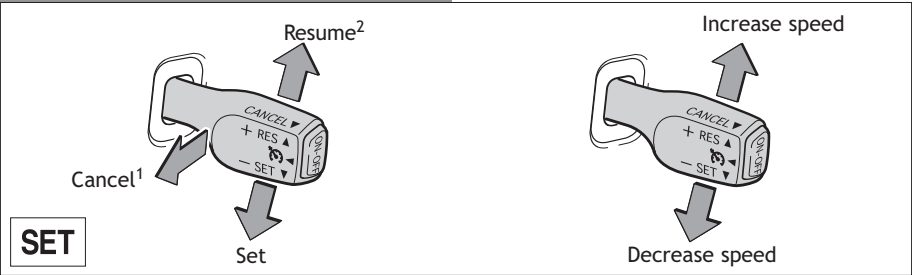

¹ The set speed may also be cancelled by depressing the brake pedal.

² The set speed may be resumed once vehicle speed exceeds 25 mph.

Dynamic Radar Cruise Control (if equipped)

Refer to the *Owner's Manual* for more details and complete safety precautions before attempting to use "Dynamic Radar Cruise Control."

Fixed speed mode

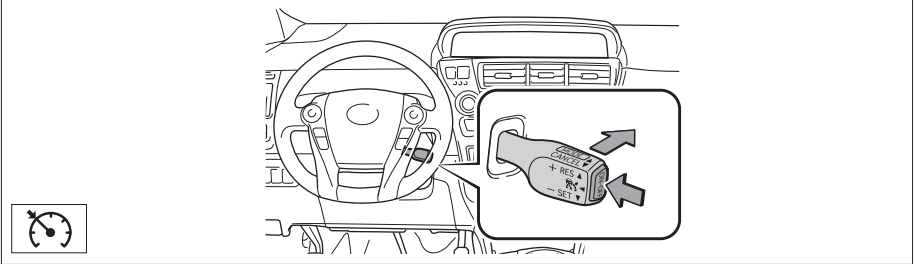

- (1) **To select conventional/fixed speed control** Push the ON-OFF button. Push the lever forward and hold until the "⏏" indicator appears.
- (2) **To set, cancel and resume a speed** Refer to instructions in the *Cruise Control* section.

Distance control mode

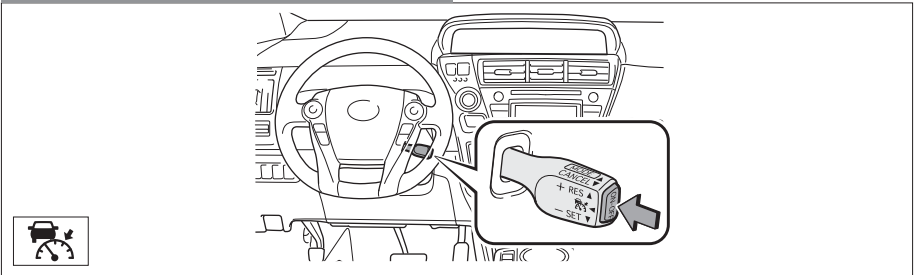

Distance control mode will cruise at a set speed, decelerate to maintain selected distance from a slower vehicle traveling in front of you, and accelerate back up to the selected speed if the vehicle in front of you changes lanes or speeds up.

- (1) **To select distance control mode** Push the ON-OFF button. The "⏏" will come on.
- (2) **To set, cancel or resume a speed** Refer to instructions for *Cruise Control* section.



- (3) **To change the vehicle-to-vehicle distance** Push the distance button to cycle through the settings, which will change progressively from LONG to MIDDLE to SHORT.

Trip information display

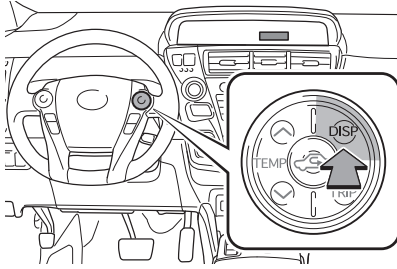

- Push “DISP” to change between the following information screens:
- (1) Current fuel consumption
 - (2) Average fuel consumption
 - (3) Cruising range
 - (4) Hybrid System Indicator set up

Telephone controls (Bluetooth®)

Microphone (type A)

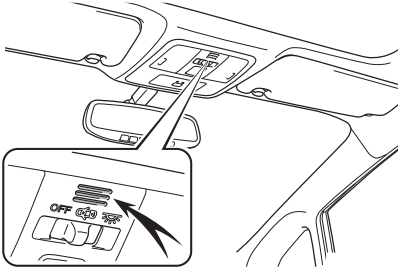

Microphone (type B)

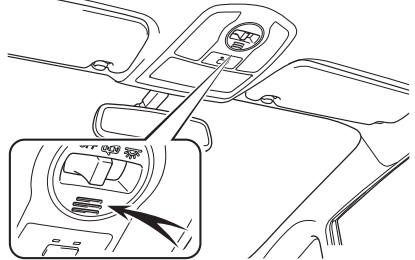

Audio unit

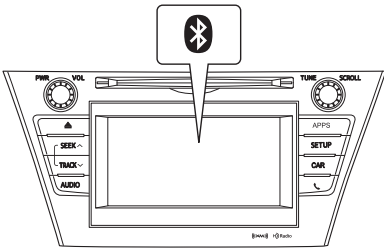

Steering wheel telephone switches

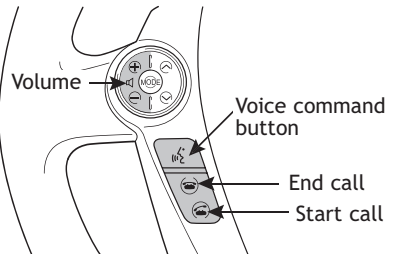

Bluetooth® technology allows dialing or receipt of calls without taking hands from the steering wheel or using a cable to connect the telephone and the system.

Refer to the “Display Audio System Owner’s Manual” or the “Navigation System Owner’s Manual” for more information about phone connections and compatibility.

Clock

H- Hour set
M- Minute set
:00- Round off
minutes

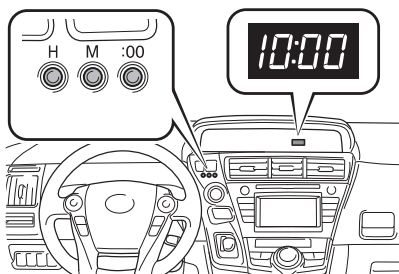

Refer to the *Owner's Manual* for details on adjusting time.

Hill-start Assist Control (HAC)

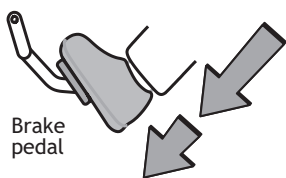

Brake
pedal

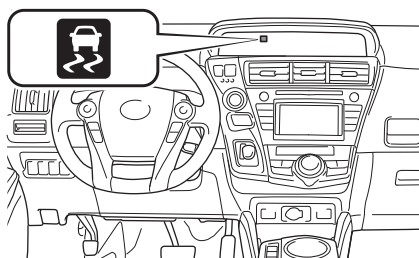

HAC helps prevent rolling backwards on an incline. To engage, push further down on brake pedal while at a complete stop until a beep sounds and slip indicator illuminates. HAC holds for approximately two seconds after releasing brake pedal.

Refer to the *Owner's Manual* for more details.

Garage door opener (HomeLink®)* (if equipped)

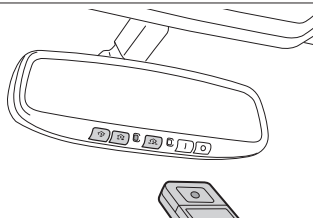

Garage door openers manufactured under license from HomeLink®* can be programmed to operate garage doors, estate gates, security lighting, etc.

Refer to "Garage door opener," Section 3-5 in the *Owner's Manual* for more details.

For programming assistance, contact HomeLink® at 1-800-355-3515, or visit <http://www.homelink.com>.

* HomeLink® is a registered trademark of Johnson Controls, Inc.

SAFETY AND EMERGENCY FEATURES

Seat belts

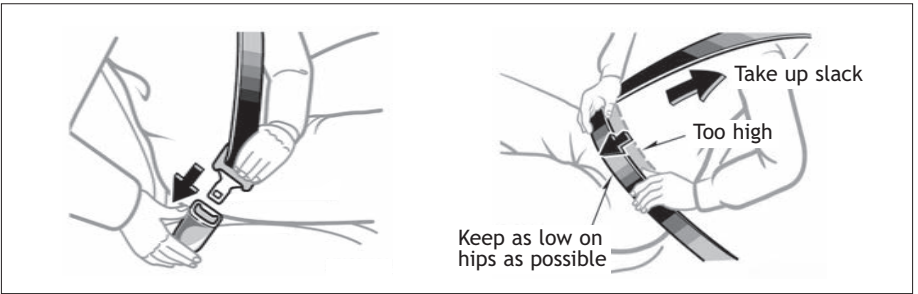

If belt is fully extended, then retracted even slightly, it cannot be re-extended beyond that point, unless fully retracted again. This feature is used to help hold child restraint systems securely.

To find more information about seat belts, and how to install a child restraint system, refer to the *Owner's Manual*.

Seat belts-Shoulder belt anchor

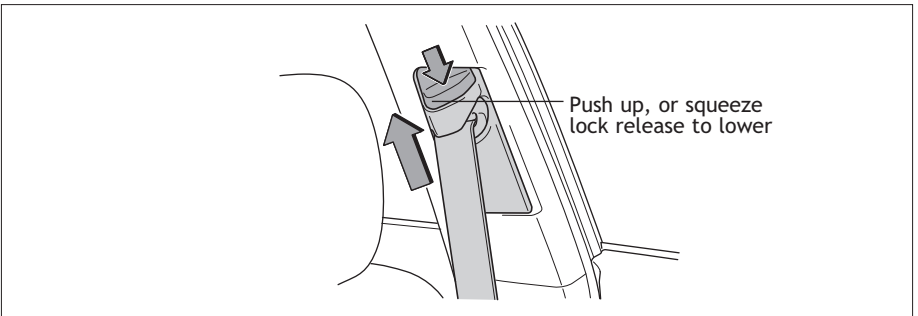

Tire Pressure Monitoring (warning) System

If the Tire Pressure Warning indicator “(↓)” illuminates without blinking, adjust tire pressures to factory-specified levels.* The light will turn off after a few minutes. The warning light may come on due to temperature changes or changes in tire pressure from natural air leakage.

If the tire pressure indicator flashes for more than 60 seconds and then remains on, take the vehicle to your local Toyota dealer.

Refer to the *Owner's Manual* for more details.

* Refer to load label on door jamb or the *Owner's Manual* for tire inflation specifications.

Door locks

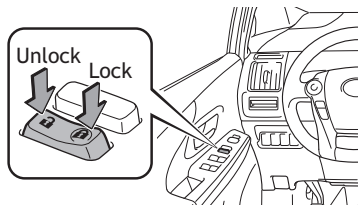

Doors-Child safety locks

Rear door

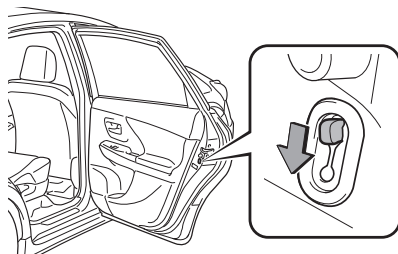

Moving the lever to “LOCK” will allow the door to be opened only from the outside.

Spare tire & tools

Tool location

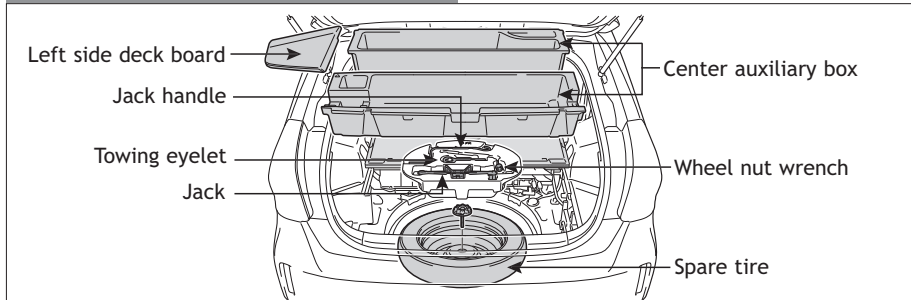

Removing the spare tire

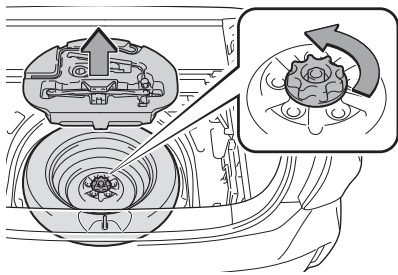

Refer to the *Owner's Manual* for tire changing and jack positioning procedures.

SAFETY AND EMERGENCY FEATURES

Star Safety System™

All new Toyota vehicles come standard with the Star Safety System™, which combines Vehicle Stability Control (VSC), Traction Control (TRAC), Anti-lock Braking System (ABS), Electronic Brake-force Distribution (EBD), Brake Assist (BA) and Smart Stop Technology (SST).

Vehicle Stability Control (VSC)

VSC helps prevent loss of traction during cornering by reducing engine power and applying brake force to selected wheels.

Toyota's VSC monitors steering angle and the direction your vehicle is traveling. When it senses that the front or rear wheels begin to lose traction, VSC reduces engine power and applies braking to selected wheels. This helps restore traction and vehicle control.

Traction Control (TRAC)

VSC helps prevent loss of traction during cornering by reducing engine power, and Traction Control helps maintain traction on loose gravel and wet, icy, or uneven surfaces by applying brake force to the spinning wheel(s).

Toyota's TRAC sensors are activated when one of the drive wheels starts to slip. TRAC limits engine output and applies the brakes to the spinning wheel. This transfers power to the wheels that still have traction to help you drive safely.

Anti-Lock Brake System (ABS)

ABS helps prevent brakes from locking up by "pulsing" brake pressure to each wheel. This limits brake lockup and provides the maximum brake effectiveness for the current road conditions.

Toyota's ABS sensors detect which wheels are locking up and limits wheel lockup by "pulsing" each wheel's brakes independently. Pulsing releases brake pressure repeatedly for fractions of a second. This helps the tires attain the maximum traction that the current road conditions will allow, helping you stay in control.

Electronic Brake Force Distribution (EBD)

Toyota's ABS technology has Electronic Brake-force Distribution (EBD) to help maintain stability and balance when braking. Abrupt stops cause the vehicle to tilt forward, reducing the braking power of the rear wheels. EBD responds to sudden stops by redistributing brake force to maximize the braking effectiveness of all four wheels.

Brake Assist (BA)

Brake Assist is designed to detect sudden or "panic" braking, and then add braking pressure to decrease the vehicle's stopping distance. When there's only a split second to react, Brake Assist can add additional brake pressure more quickly than just the driver alone can.

Smart Stop Technology (SST)

Smart Stop Technology automatically reduces engine power when the accelerator and brake pedals are pressed simultaneously under certain conditions.

SST engages when the accelerator is depressed first and the brakes are applied firmly for longer than one-half second at speeds greater than five miles per hour.

SST doesn't engage if the brake pedal is depressed before the accelerator pedal, allowing vehicles to start on a steep hill and safely accelerate without rolling backward.

Floor mat installation

There are two types of Toyota floor mats: carpeted and all-weather. Each vehicle has model-specific floor mats. Installation is easy.

For safety, follow these steps:

- Only use floor mats designed for your specific model.
- Use only one floor mat at a time, using the retaining hooks to keep the mat in place.
- Install floor mats right side up.

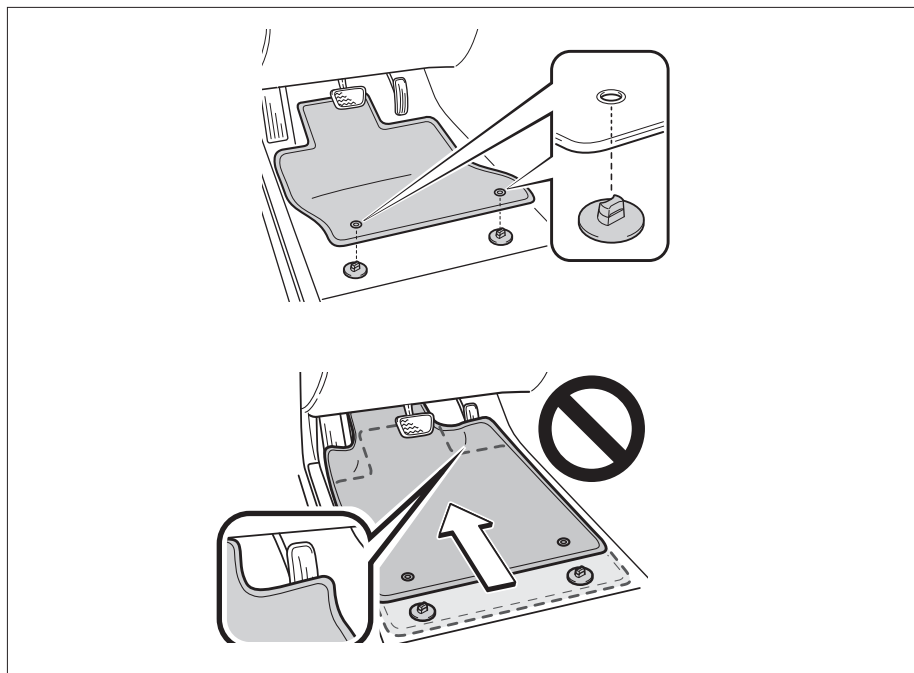

NOTES



TOYOTA Owners

toyota.com/owners

CUSTOMER EXPERIENCE CENTER

1-800-331-4331

