

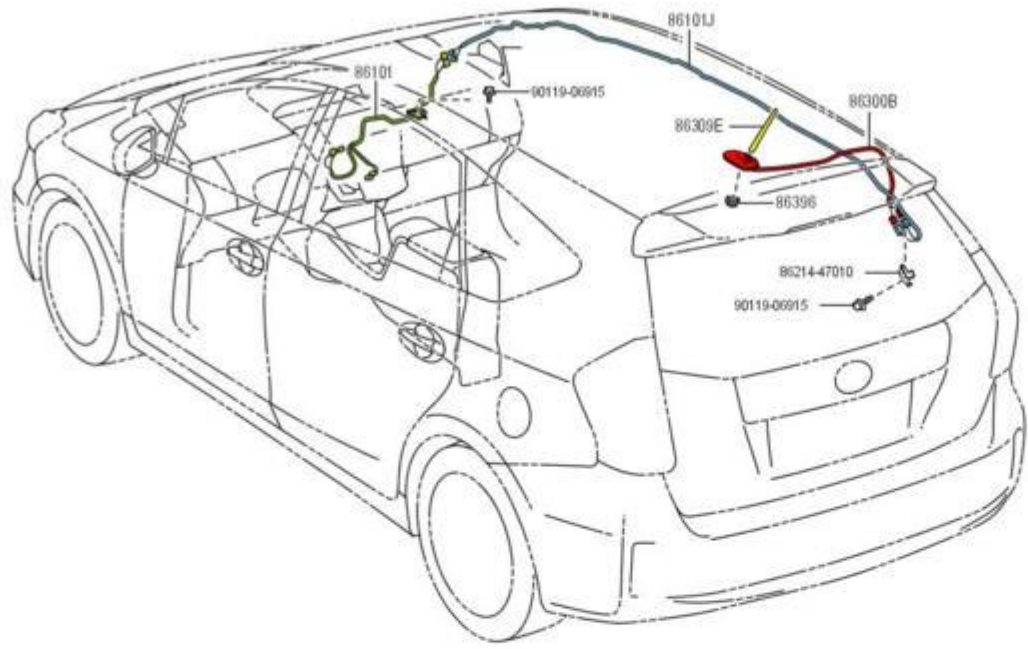

Antenna

(1109-) from 201109.



864499

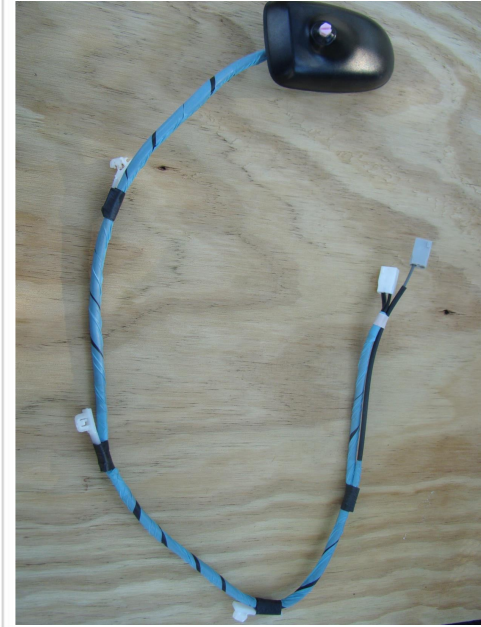

Showing Genuine Parts that fit your: 2012 Toyota Prius V 1800CC 16-VALVE DOHC EFI, AUTOMATIC, ATM STEPLESS

[Change Vehicle](#)

Standard Radio No Satellite or Safety Connect

86300B	<u>ANTENNA ASSEMBLY, AMPLIFIER, No.1. ANTENNA ASSY, AMPLIF</u> PRIUS V (ZVW41)	▶ 8630047090	\$130.39 \$97.20
86300B	<u>ANTENNA ASSEMBLY, AMPLIFIER, No.1. ANTENNA ASSY, SATELL: AUDIO-AVN 8SPE...</u> PRIUS V (ZVW41)	▶ 8696047031	\$229.46 \$165.54
86300B	<u>ANTENNA ASSEMBLY, AMPLIFIER, No.1. ANTENNA ASSY, TELEPH: AUDIO-AVN 8SP...</u> PRIUS V (ZVW41); USA	▶ 8676047031	\$269.11 \$194.15

With Safety Connect Cellular "May Day"

With Satellite Radio

1. Remove all Back Foam Panels
2. Remove 12v Battery Cover Panel (not shown here)
3. Remove Panel over HV Battery to Back Seat "Rear #1 Floor Board" (One 10mm bolt and Clips)
4. Remove "Back Door Scuff Plate" at Rear Hatch
5. Remove Right Rear Door Scuff Plate
6. Remove Rear "Right Seat Outer Belt" 22mm on Floor
7. Remove Lower Right "Deck Trim Side Panel" and "Trim Panels" on same (two – one covers bolt and the other is the 12v outlet) (Two 10mm bolts –and Clips) (Remove Third 10 mm bolt if equipped with Cargo Net)
8. Remove Upper Right Panel with Clips
9. Remove Upper Right Small Window Panel "Rear Roof Side Rail" with Clips
10. Remove three Exposed Push Clips holding Headliner in back
11. Partially Pull Headliner Down until Antenna Base Nut and Cables are Accessible
12. Remove Antenna Connectors first then Cable Retainers starting at Connector End.
13. Remove Base Nut and depress built in retainer hooks to remove. (See new part for clarity)

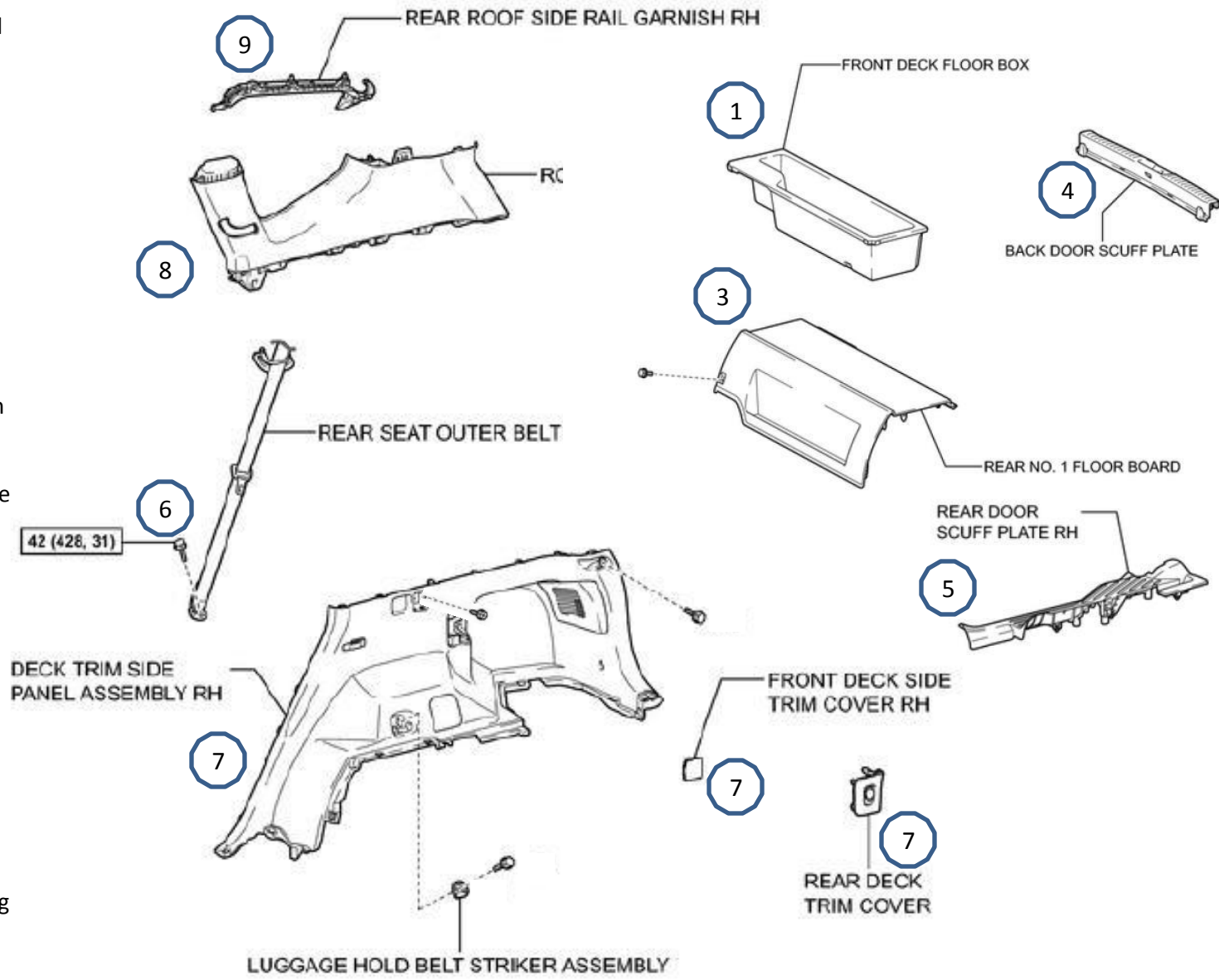

l'm (kgf*cm, ft.*lbf): Specified torque

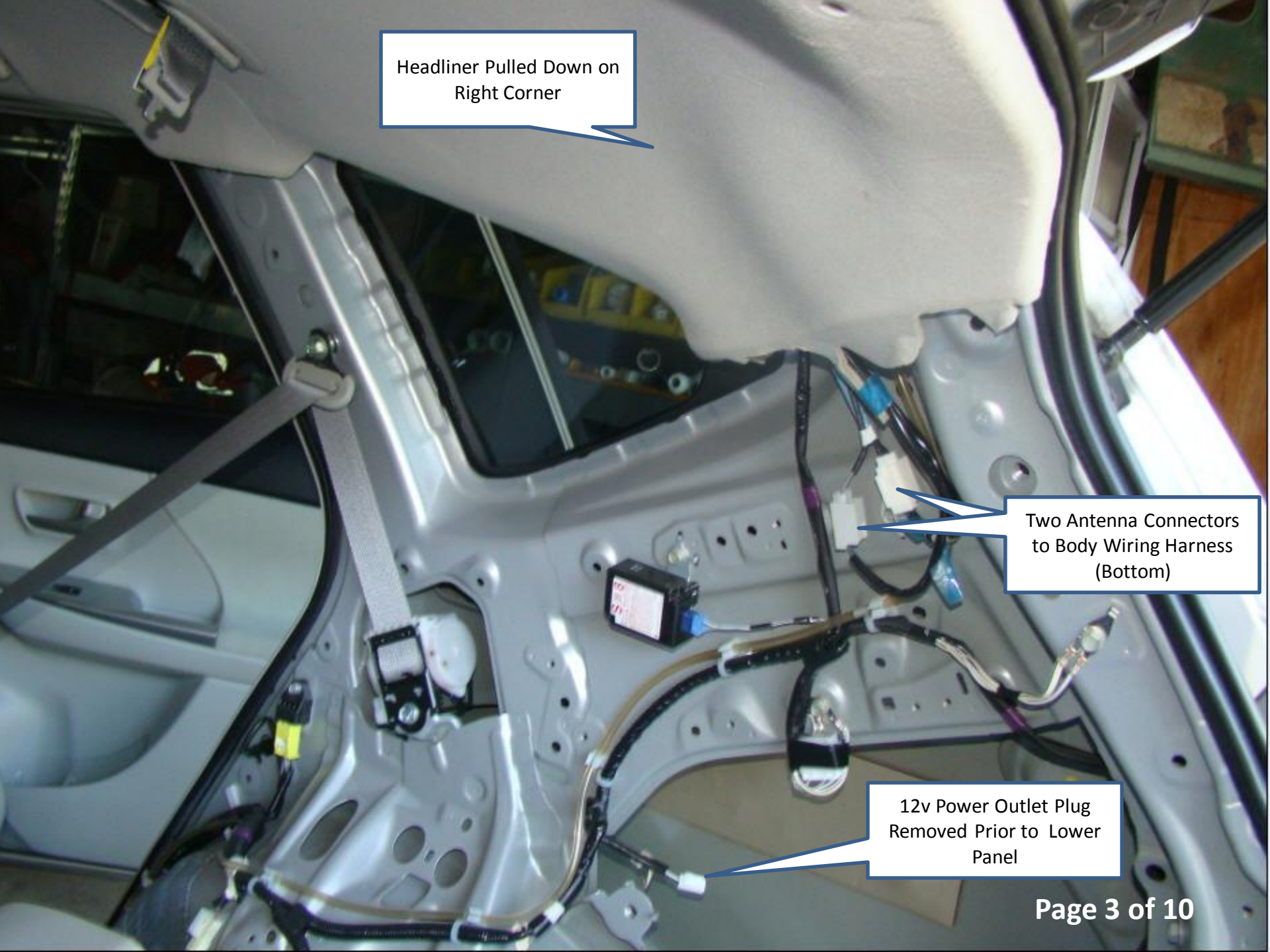

Headliner Pulled Down on
Right Corner

Two Antenna Connectors
to Body Wiring Harness
(Bottom)

12v Power Outlet Plug
Removed Prior to Lower
Panel



Panels Removed in this Picture

1. Remove all Back Foam Panels
2. Remove 12v Battery Cover Panel
3. Remove Panel over HV Battery to Back Seat "Rear #1 Floor Board" (One 10mm bolt and Clips)
4. Remove "Back Door Scuff Plate" at Rear Hatch
5. Remove Right Rear Door Scuff Plate (pic next page)
6. Remove Rear "Right Seat Outer Belt" 22mm on Floor (next page)
7. Remove Lower Right "Deck Trim Side Panel" and "Trim Panels" on same (two – one covers bolt and the other is the 12v outlet) (Two 10mm bolts – and Clips) (Remove Third 10 mm bolt if equipped with Cargo Net)
8. Remove Upper Right Panel with Clips
9. Remove Upper Right Small Window Panel "Rear Roof Side Rail" with Clips (next page)
10. Remove three Exposed Push Clips holding Headliner in back (next page)
11. Partially Pull Headliner Down until Antenna Base Nut and Cables are Accessible (next page)
12. Remove Antenna Connectors first then Cable Retainers starting at Connector End (next page).
13. Remove Base Nut and depress built in retainer hooks to remove. (See new part for clarity)

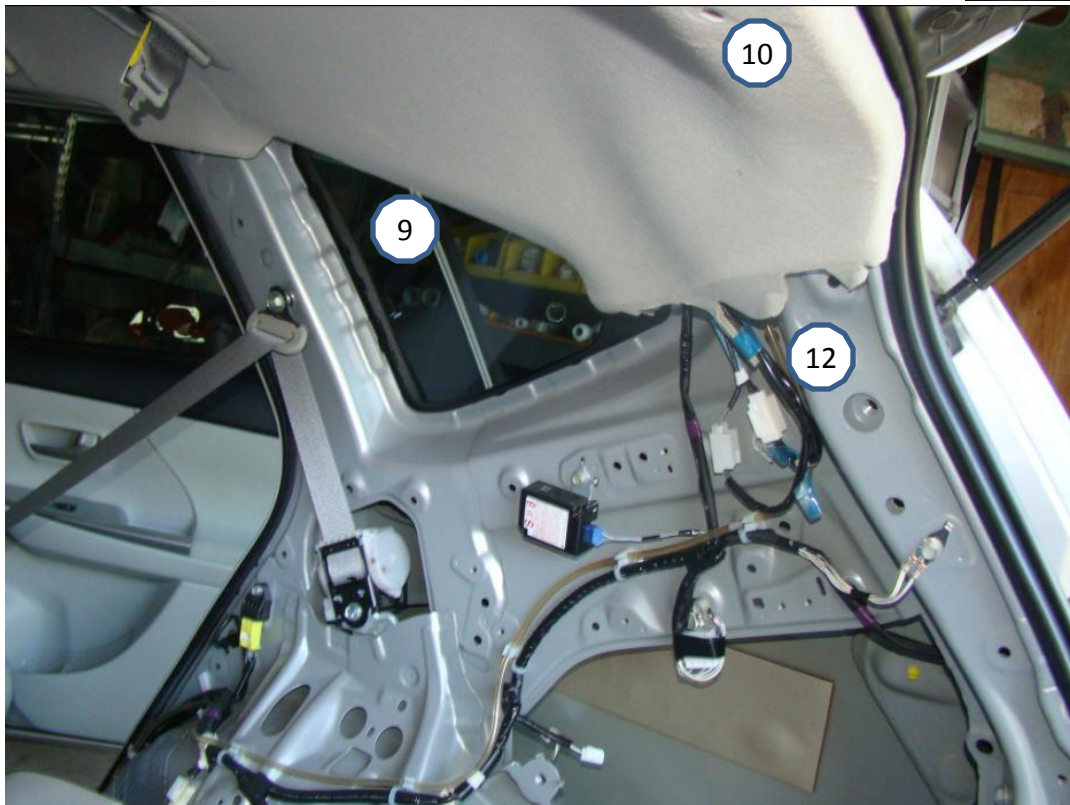
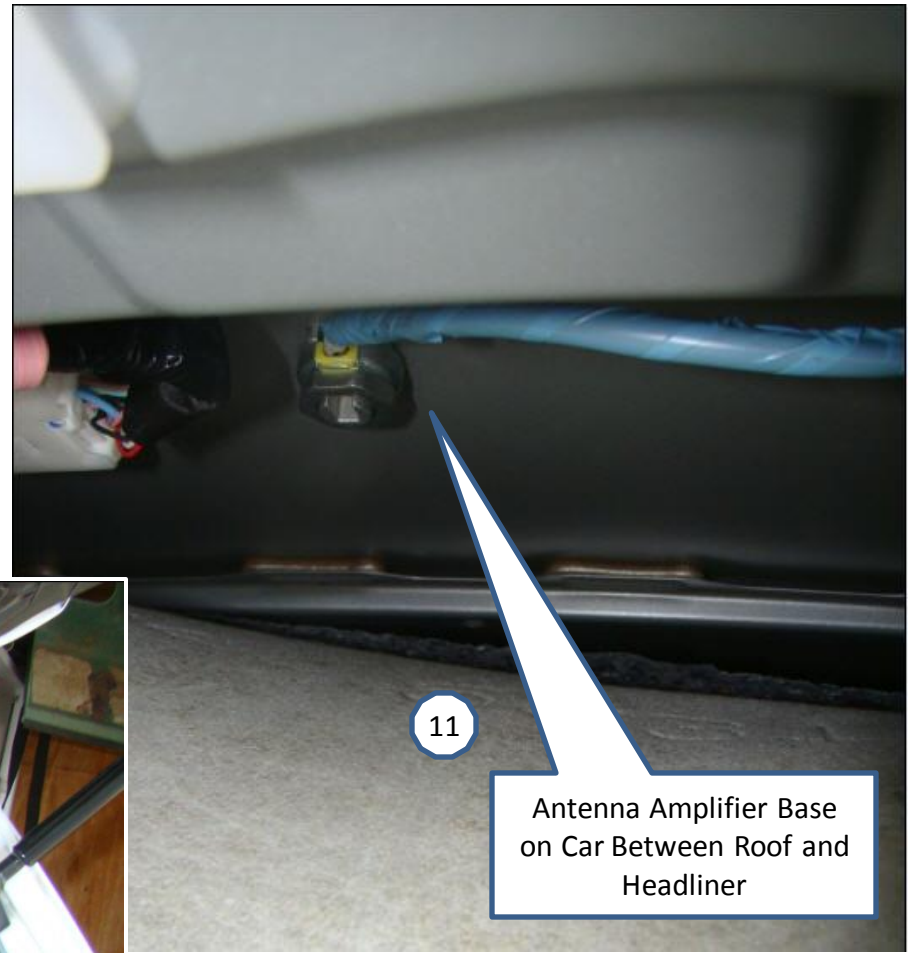
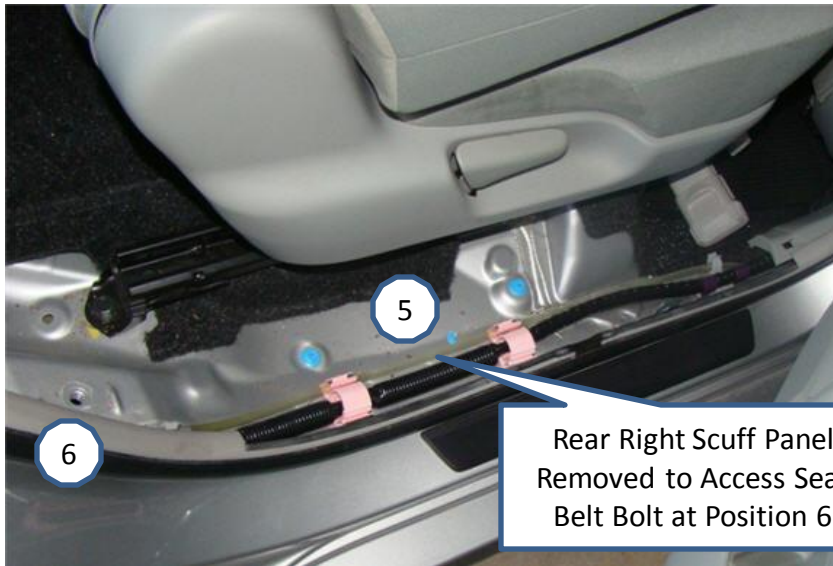

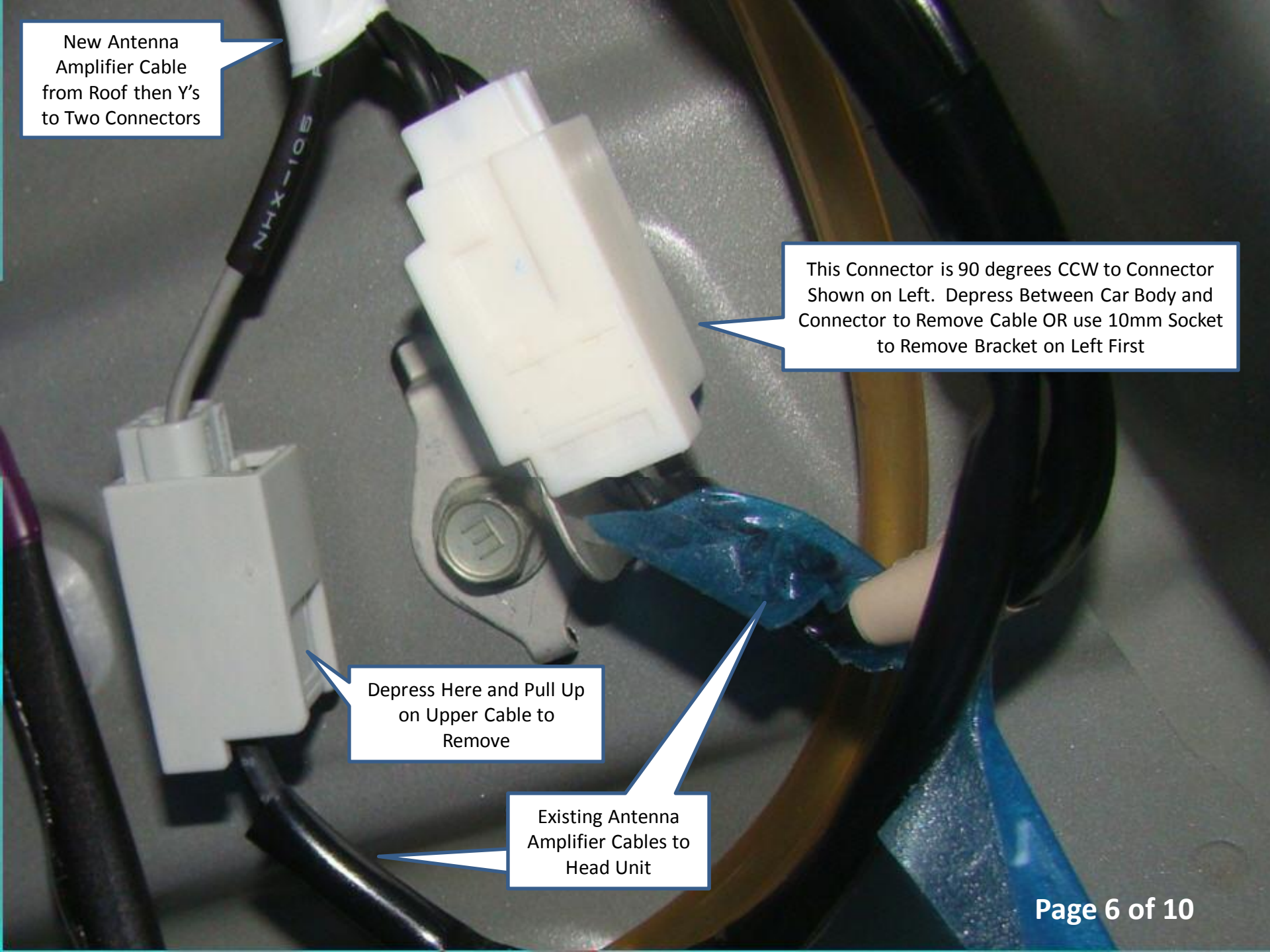
A close-up photograph of a car's antenna amplifier system. The image shows a grey metal surface with several cables and connectors. A black cable with 'NHX-105' printed on it is connected to a white plastic connector. Another white plastic connector is visible to the left. A blue plastic component is attached to the bottom of the main white connector. A metal bracket with a circular hole is also present. Callout boxes with blue borders and white text provide instructions for removing the cables and connectors.

New Antenna
Amplifier Cable
from Roof then Y's
to Two Connectors

This Connector is 90 degrees CCW to Connector
Shown on Left. Depress Between Car Body and
Connector to Remove Cable OR use 10mm Socket
to Remove Bracket on Left First

Depress Here and Pull Up
on Upper Cable to
Remove

Existing Antenna
Amplifier Cables to
Head Unit

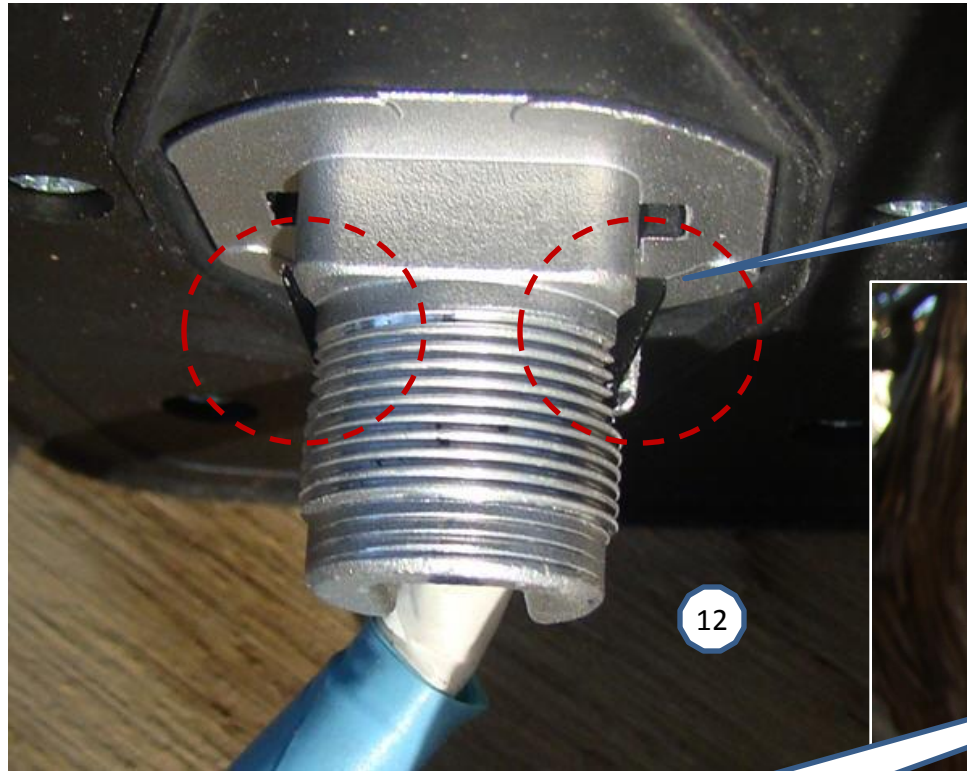

Two Spring Loaded Black Retainer Latches



Press at Top of Threads after Nut Removed and Push Up Through Roof



Antenna Nut Installed This End Up

The Cable Exits through the Yellow Plastic Channel – Only the Nut Rotates



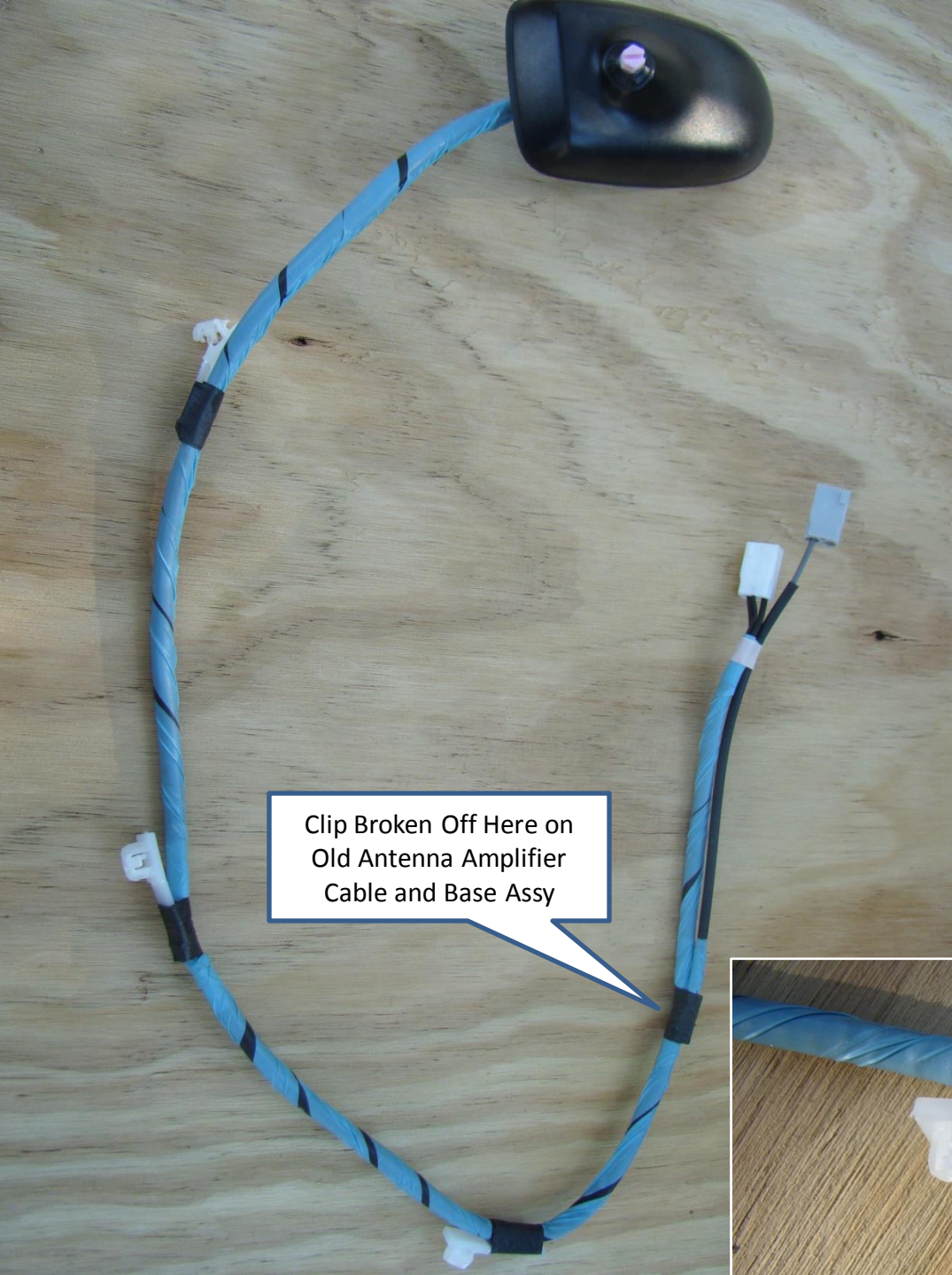

Clip Broken Off Here on Old Antenna Amplifier Cable and Base Assy

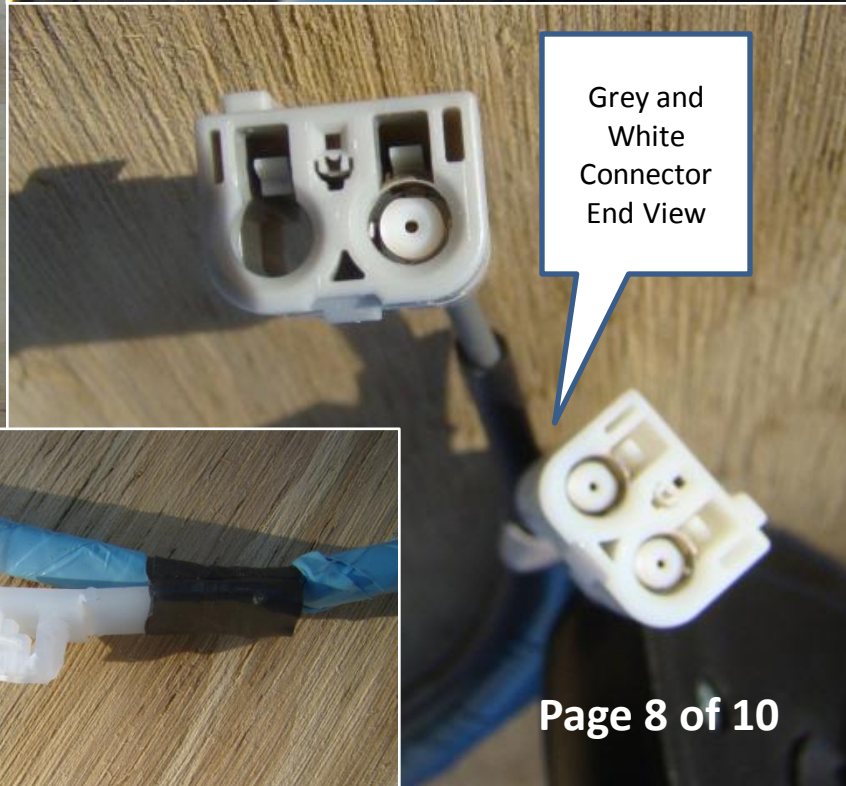

Grey and White Connector End View



Toyota

onlineparts.com

We earn your trust every day

Toyota Online Parts

Billing Information

Richard

Email:

Customer Notes: Ship part 86960-47031 only - not earlier revisions
 Vehicle Identification Number: JTDZN3EU8C3028704

Order ID:

Created at: 01/24/2016 - 03:09:08 PM

Last status change: 01/24/2016 - 03:09:08 PM

Toyota Online Parts
 9319 West Broad Street,
 Richmond, Virginia 23294
 USA

Phone: 1-800-888-9753 Press #
 3 Toyota Wholesale Parts
 Fax:
 Email: service@toyotaonlineparts.com
 Website:
<http://www.toyotaonlineparts.com>



Product ID	Product Name	List Price	Your Price	Quantity	Total
86960-47031	ANTENNA ASSY SATELL	\$229.46	\$154.37	1	\$154.37
			(not taxable)		
	Shipping (UPS - Ground (1-5 days in transit from shipping date check transit time map - (Link at bottom of pag) :				\$154.37
					\$22.24
	Total :				\$176.61

Payment Information

Method : Real-time, PayPal Express Checkout
 Gateway : PayPal Express Checkout
 Completed at : 01/24/2016 - 03:09:08 PM
Order Custom Fields Values
 VIN NUMBER :

4

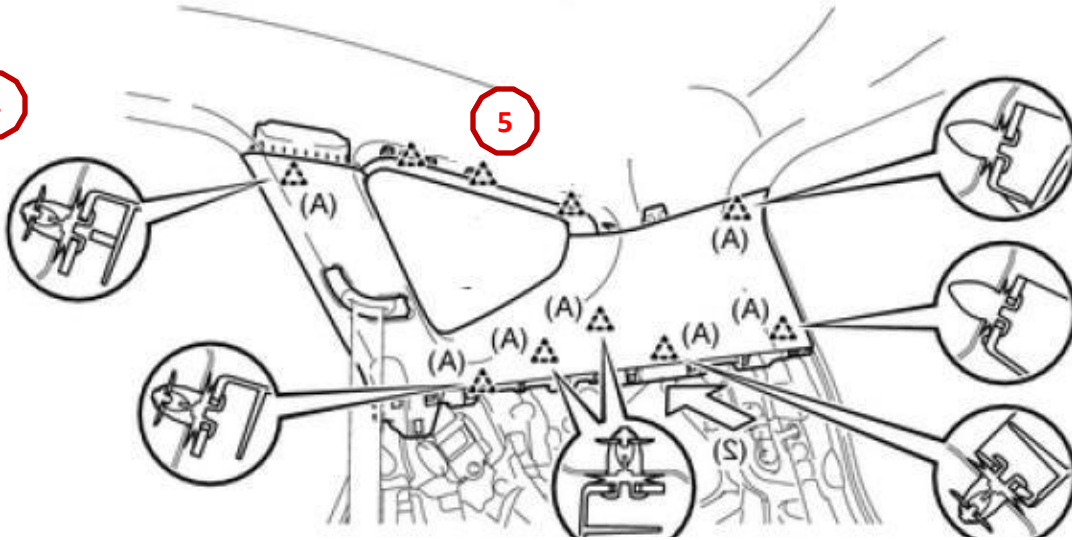

5

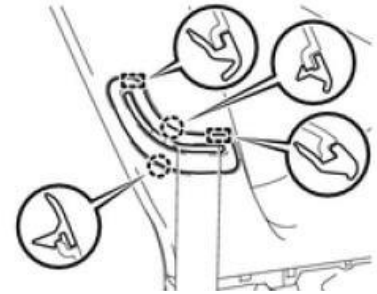

Seat Belt Guide (Left In Panel but could be removed)

3

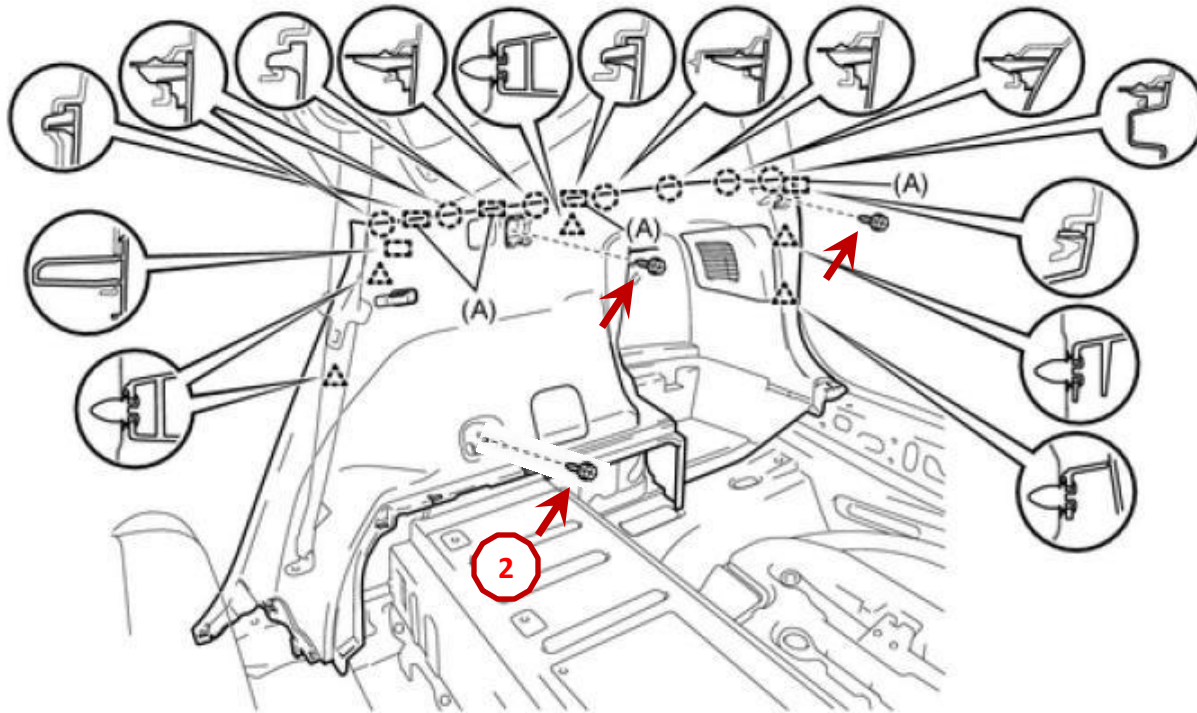

2

1

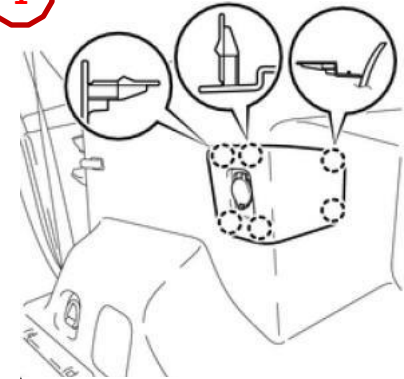

12v Power Outlet Panel Removed and Disconnected