

Last Modified: 01-14-2019	6.8:8.0.48	Doc ID: RM100000000S0K9
Model Year Start: 2016	Model: Prius	Prod Date Range: [11/2015 - 12/2018]
Title: EXTERIOR PANELS / TRIM: BACK DOOR OUTSIDE GARNISH: COMPONENTS; 2016 - 2018 MY Prius [11/2015 - 12/2018]		

COMPONENTS

ILLUSTRATION

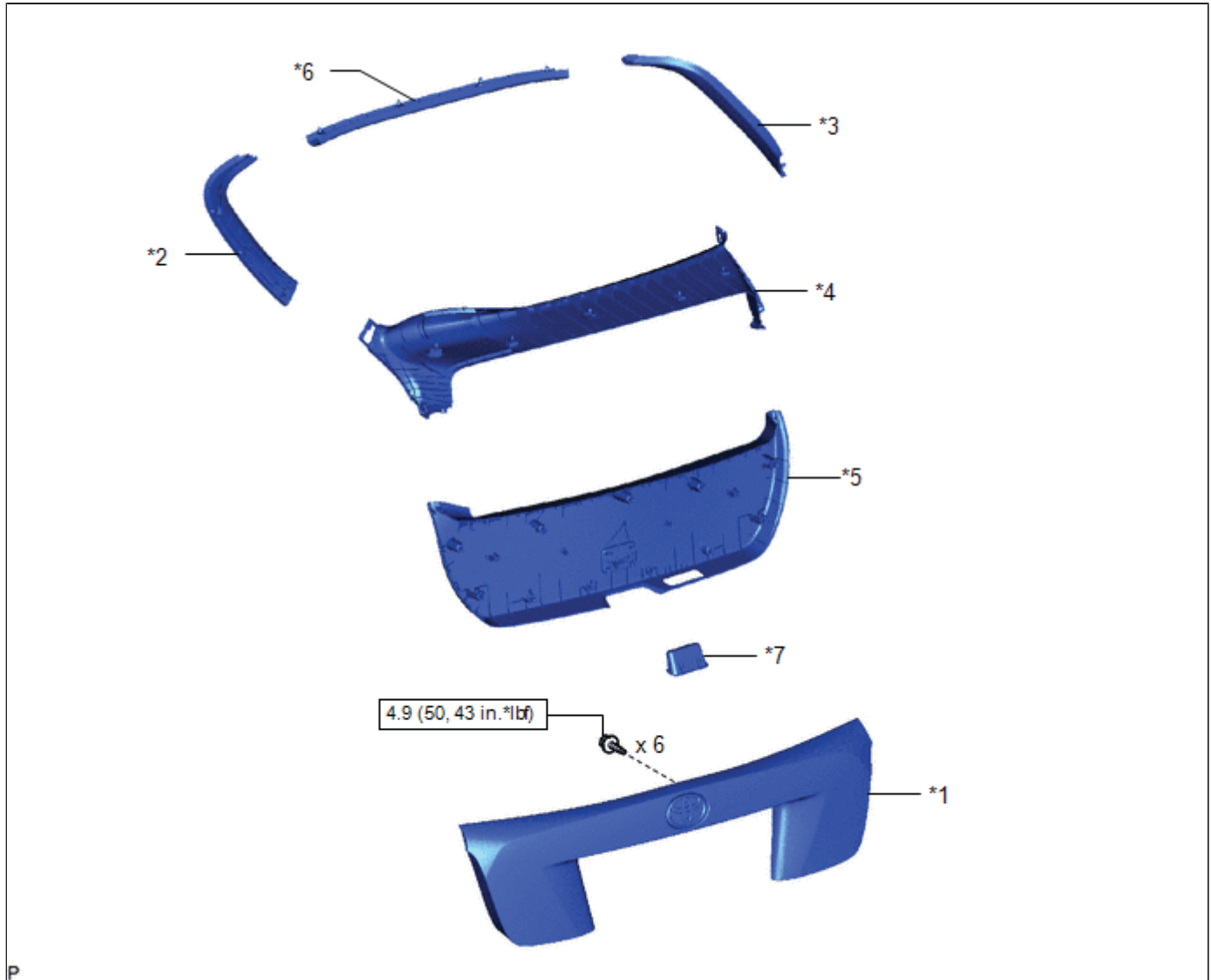

*1	BACK DOOR OUTSIDE GARNISH SUB-ASSEMBLY	*2	BACK DOOR SIDE GARNISH LH
*3	BACK DOOR SIDE GARNISH RH	*4	BACK DOOR TRIM BOARD
*5	BACK DOOR TRIM BOARD ASSEMBLY	*6	BACK DOOR UPPER TRIM PANEL ASSEMBLY
*7	DOOR PULL HANDLE	-	-

	N*m (kgf*cm, ft.*lbf): Specified torque	-	-
--	---	---	---

ILLUSTRATION

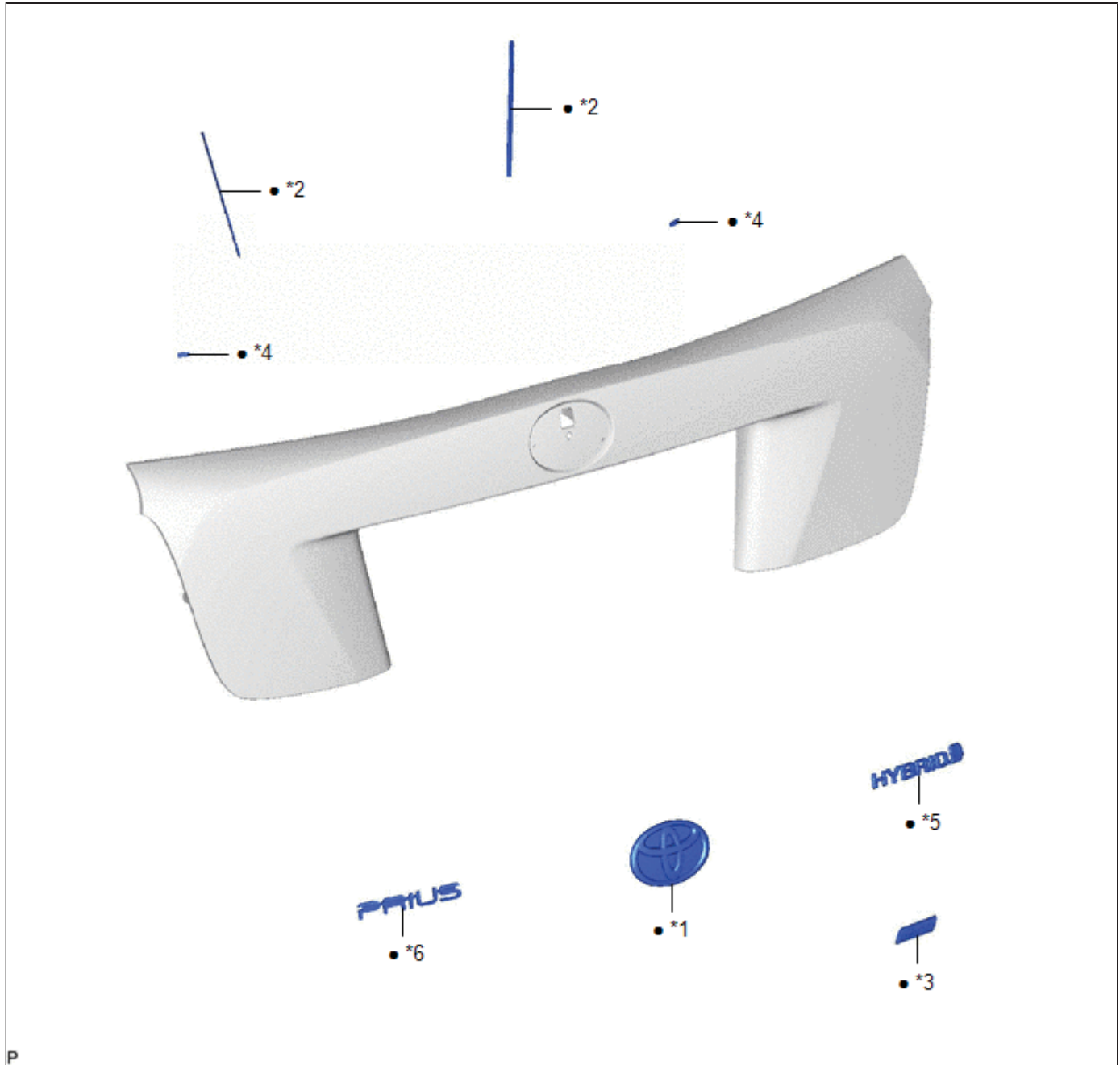

P

*1	BACK DOOR ORNAMENT SUB-ASSEMBLY	*2	BACK DOOR OUTSIDE GARNISH PROTECTOR
*3	NO. 1 BACK DOOR NAME PLATE	*4	NO. 2 BACK DOOR OUTSIDE GARNISH PROTECTOR
*5	NO. 2 LUGGAGE COMPARTMENT DOOR	*6	NO. 3 LUGGAGE COMPARTMENT DOOR

	NAME PLATE		PLATE
•	Non-reusable part	-	-

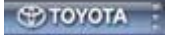

Last Modified: 01-14-2019	6.8:8.0.48	Doc ID: RM100000000SJT4
Model Year Start: 2016	Model: Prius	Prod Date Range: [11/2015 - 12/2018]
Title: EXTERIOR PANELS / TRIM: BACK DOOR OUTSIDE GARNISH: DISASSEMBLY; 2016 - 2018 MY Prius [11/2015 - 12/2018]		

DISASSEMBLY

CAUTION / NOTICE / HINT

HINT:

When removing the name plates, heat the back door outside garnish and name plates using a heat light.

Heating Temperature

ITEM	TEMPERATURE
<ul style="list-style-type: none"> Back Door Outside Garnish Name Plate 	20 to 30°C (68 to 86°F)

CAUTION:

- Do not touch the heat light and heated parts, touching the heat light may result in burns.
- Touching heated parts for a long time may result in burns.

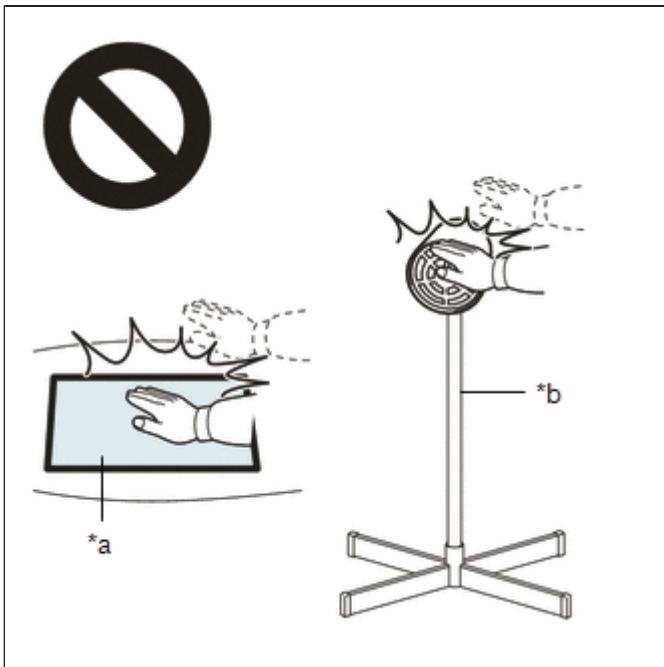

*a	Heated Part
*b	Heat Light

NOTICE:

Do not heat the back door outside garnish or name plate excessively.

PROCEDURE

1. REMOVE NO. 2 BACK DOOR OUTSIDE GARNISH PROTECTOR

(a) Remove the No. 2 back door outside garnish protector.

HINT:

Use the same procedure for the RH side and LH side.

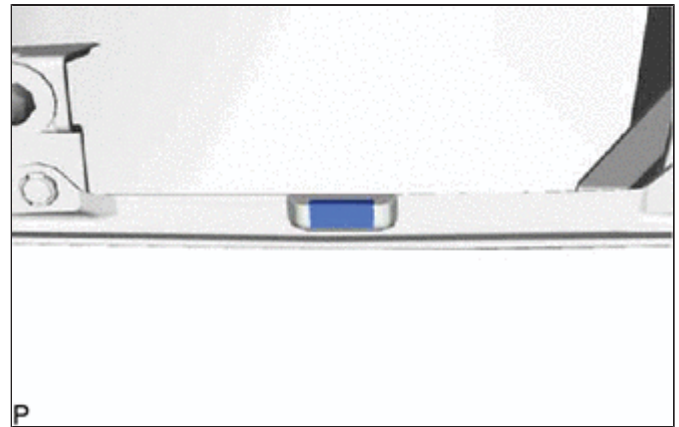

2. REMOVE BACK DOOR OUTSIDE GARNISH PROTECTOR

(a) Remove the back door outside garnish protector.

HINT:

Use the same procedure for the RH side and LH side.

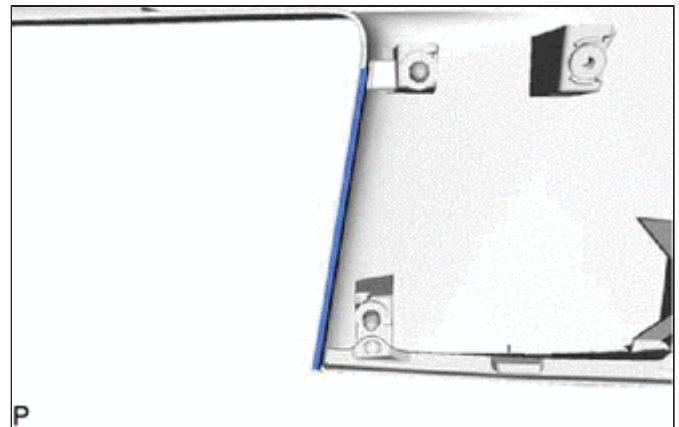

3. REMOVE NO. 2 LUGGAGE COMPARTMENT DOOR NAME PLATE

Click here [INFO](#)

4. REMOVE NO. 1 BACK DOOR NAME PLATE

Click here [INFO](#)

5. REMOVE NO. 3 LUGGAGE COMPARTMENT DOOR PLATE

Click here [INFO](#)

6. REMOVE BACK DOOR ORNAMENT SUB-ASSEMBLY

Click here [INFO](#)

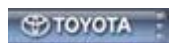

Last Modified: 01-14-2019	6.8:8.0.48	Doc ID: RM100000000S0KB
Model Year Start: 2016	Model: Prius	Prod Date Range: [11/2015 - 12/2018]
Title: EXTERIOR PANELS / TRIM: BACK DOOR OUTSIDE GARNISH: INSTALLATION; 2016 - 2018 MY Prius [11/2015 - 12/2018]		

INSTALLATION

PROCEDURE

1. INSTALL BACK DOOR OUTSIDE GARNISH SUB-ASSEMBLY

(a) Pull back the lower No. 2 back window moulding and secure it with tape as shown in the illustration.

NOTICE:

Be careful not to damage the lower No. 2 back window moulding.

HINT:

- Use wide tape to ensure strong enough adhesion.
- Use non-residue tape.
- If necessary, clean the lower No. 2 back window moulding before securing it with tape.

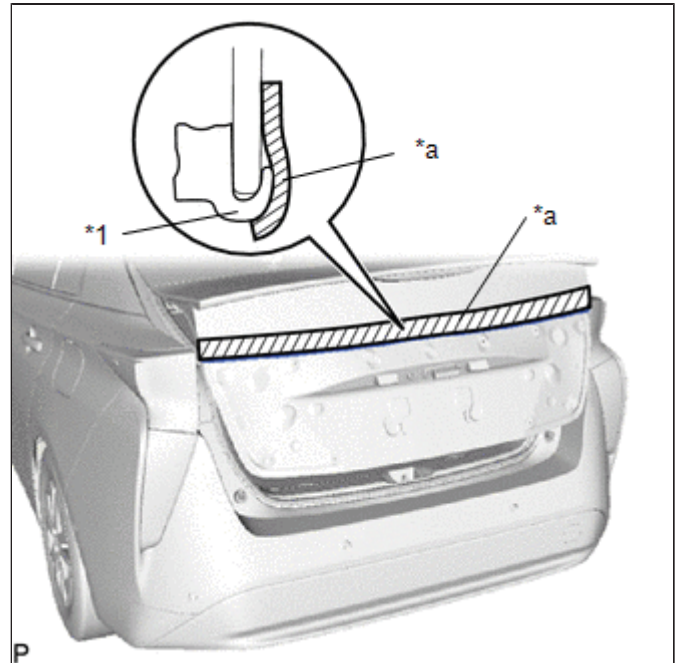

*1	Lower No. 2 Back Window Moulding
*a	Tape

(b) Engage the 13 clips as shown in the illustration.

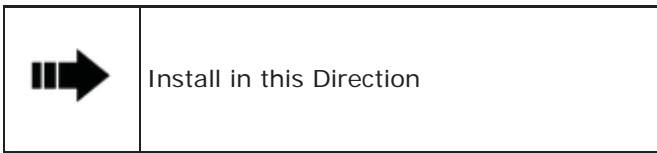
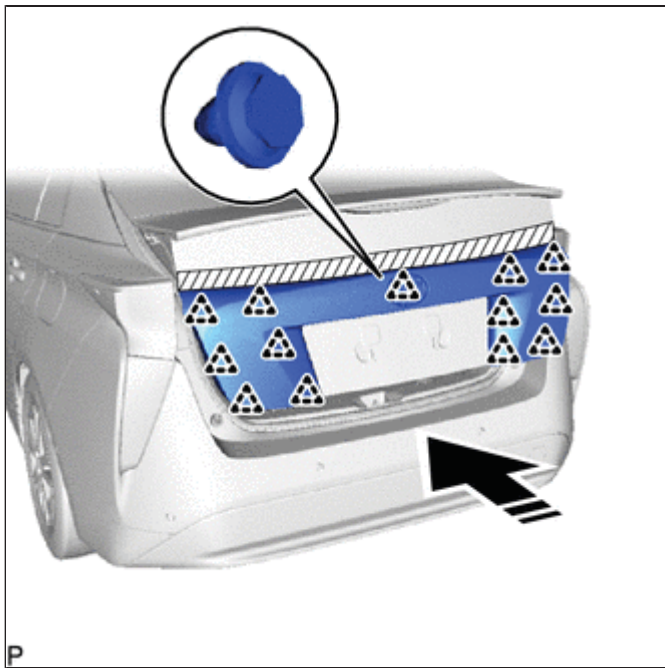

HINT:
Check that the lower No. 2 back window moulding is not caught under the back door outside garnish sub-assembly.

(c) Install the back door outside garnish sub-assembly with the 6 bolts.

Torque:

4.9 N·m { 50 kgf·cm, 43 in·lbf }

(d) Remove the tape.

NOTICE:
Be careful not to damage the lower No. 2 back window moulding.

2. INSTALL BACK DOOR TRIM BOARD

Click here [INFO](#)

3. INSTALL BACK DOOR TRIM BOARD ASSEMBLY

Click here [INFO](#)

4. INSTALL DOOR PULL HANDLE

Click here [INFO](#)

5. INSTALL BACK DOOR SIDE GARNISH LH

Click here [INFO](#)

6. INSTALL BACK DOOR SIDE GARNISH RH

HINT:
Use the same procedure as for the LH side.

7. INSTALL BACK DOOR UPPER TRIM PANEL ASSEMBLY

Click here [INFO](#)



Last Modified: 01-14-2019	6.8:8.0.48	Doc ID: RM100000000SJT5
Model Year Start: 2016	Model: Prius	Prod Date Range: [11/2015 - 12/2018]
Title: EXTERIOR PANELS / TRIM: BACK DOOR OUTSIDE GARNISH: REASSEMBLY; 2016 - 2018 MY Prius [11/2015 - 12/2018]		

REASSEMBLY

CAUTION / NOTICE / HINT

HINT:

When installing the name plates, heat the back door outside garnish and name plates using a heat light.

Heating Temperature

ITEM	TEMPERATURE
<ul style="list-style-type: none"> Back Door Outside Garnish Name Plate 	20 to 30°C (68 to 86°F)

CAUTION:

- Do not touch the heat light and heated parts, touching the heat light may result in burns.
- Touching heated parts for a long time may result in burns.

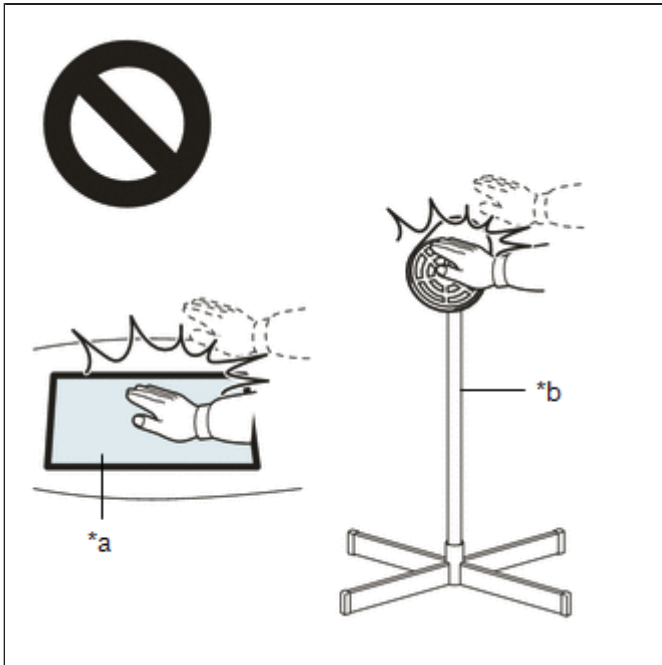

*a	Heated Part
*b	Heat Light

NOTICE:

Do not heat the back door outside garnish or name plate excessively.

PROCEDURE

1. INSTALL BACK DOOR ORNAMENT SUB-ASSEMBLY

[Click here](#)

INFO

2. INSTALL NO. 3 LUGGAGE COMPARTMENT DOOR PLATE

Click here [INFO](#)

3. INSTALL NO. 1 BACK DOOR NAME PLATE

Click here [INFO](#)

4. INSTALL NO. 2 LUGGAGE COMPARTMENT DOOR NAME PLATE

Click here [INFO](#)

5. INSTALL BACK DOOR OUTSIDE GARNISH PROTECTOR

HINT:

When installing the back door outside garnish protector, heat the back door outside garnish using a heat light.

Heating Temperature

ITEM	TEMPERATURE
Back Door Outside Garnish	20 to 30°C (68 to 86°F)

CAUTION:

- Do not touch the heat light and heated parts, touching the heat light may result in burns.
- Touching heated parts for a long time may result in burns.

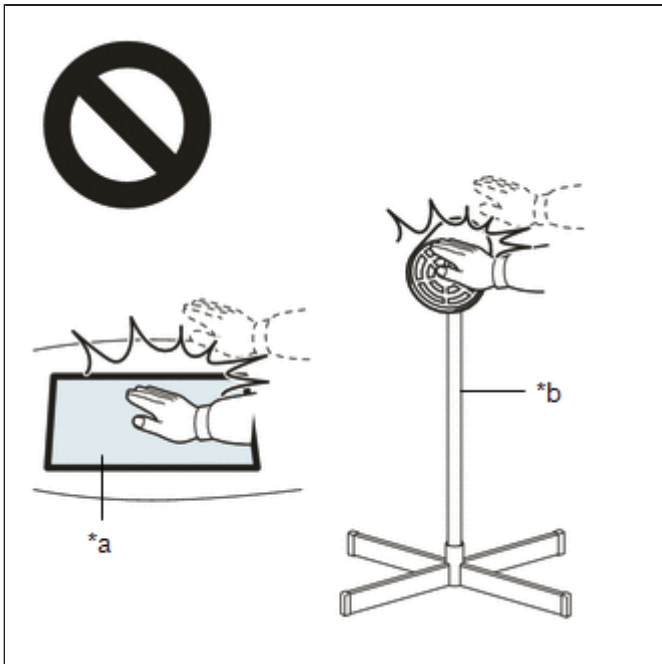

*a	Heated Part
*b	Heat Light

NOTICE:

Do not heat the back door outside garnish excessively.

(a) Clean the back door outside garnish surface.

(1) Using a heat light, heat the back door outside garnish surface.

- (2) Remove the double-sided tape from the back door outside garnish.
- (3) Wipe off any tape adhesive residue with cleaner.
- (b) Using a heat light, heat the back door outside garnish.
- (c) Remove the release paper from a new back door outside garnish protector.

HINT:

After removing the release paper, keep the exposed adhesive free from foreign matter.

- (d) Install the back door outside garnish protector as shown in the illustration.

HINT:

- Make sure to install the back door outside garnish protector so that the ends of the back door outside garnish protector are within the area shown in the illustration.
- Use the same procedure for the RH side and LH side.

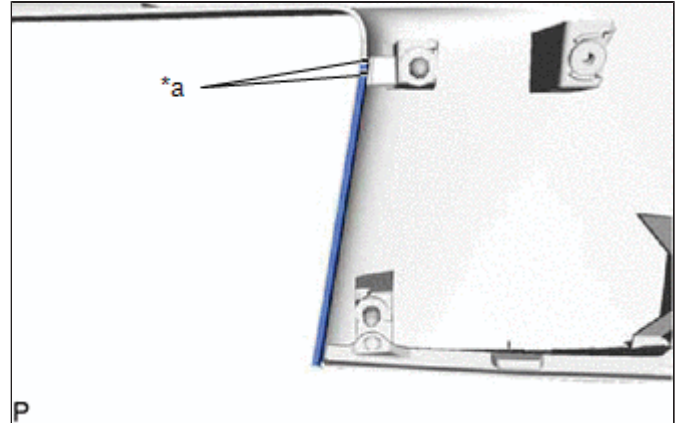

*a	Line
----	------

6. INSTALL NO. 2 BACK DOOR OUTSIDE GARNISH PROTECTOR

HINT:

When installing the No. 2 back door outside garnish protector, heat the back door outside garnish using a heat light.

Heating Temperature

ITEM	TEMPERATURE
Back Door Outside Garnish	20 to 30°C (68 to 86°F)

CAUTION:

- Do not touch the heat light and heated parts, touching the heat light may result in burns.
- Touching heated parts for a long time may result in burns.

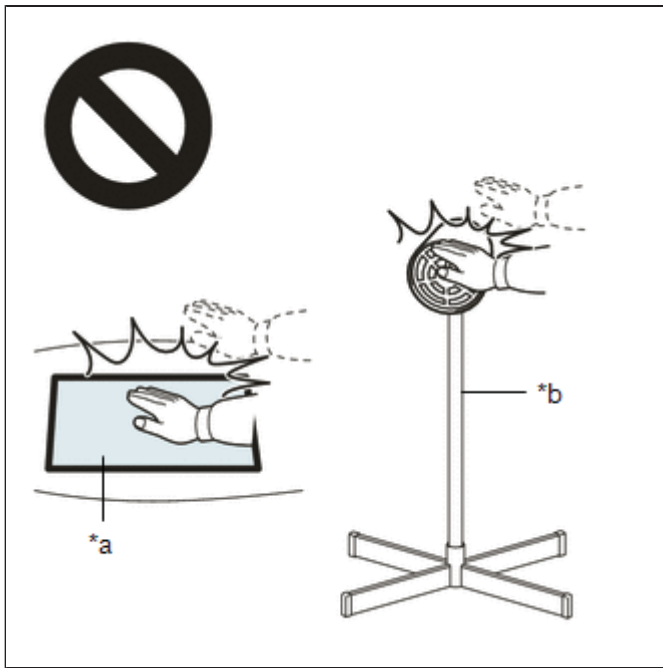

*a	Heated Part
*b	Heat Light

NOTICE:

Do not heat the back door outside garnish excessively.

(a) Clean the back door outside garnish surface.

- (1) Using a heat light, heat the back door outside garnish surface.
- (2) Remove the double-sided tape from the back door outside garnish.
- (3) Wipe off any tape adhesive residue with cleaner.

(b) Using a heat light, heat the back door outside garnish.

(c) Remove the release paper from a new No. 2 back door outside garnish protector.

HINT:

After removing the release paper, keep the exposed adhesive free from foreign matter.

(d) Install the No. 2 back door outside garnish protector as shown in the illustration.

HINT:

- Make sure to install the No. 2 back door outside garnish protector so that the ends of the No. 2 back door outside garnish protector are within the area shown in the illustration.
- Use the same procedure for the RH side and LH side.

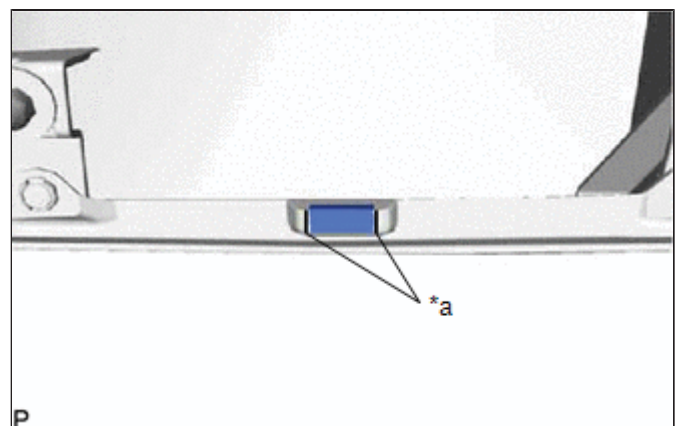

*a	Line
----	------



Last Modified: 01-14-2019	6.8:8.0.48	Doc ID: RM100000000SOKA
Model Year Start: 2016	Model: Prius	Prod Date Range: [11/2015 - 12/2018]
Title: EXTERIOR PANELS / TRIM: BACK DOOR OUTSIDE GARNISH: REMOVAL; 2016 - 2018 MY Prius [11/2015 - 12/2018]		

REMOVAL

PROCEDURE

1. REMOVE BACK DOOR UPPER TRIM PANEL ASSEMBLY

Click here [INFO](#)

2. REMOVE BACK DOOR SIDE GARNISH LH

Click here [INFO](#)

3. REMOVE BACK DOOR SIDE GARNISH RH

HINT:

Use the same procedure as for the LH side.

4. REMOVE DOOR PULL HANDLE

Click here [INFO](#)

5. REMOVE BACK DOOR TRIM BOARD ASSEMBLY

Click here [INFO](#)

6. REMOVE BACK DOOR TRIM BOARD

Click here [INFO](#)

7. REMOVE BACK DOOR OUTSIDE GARNISH SUB-ASSEMBLY

(a) Remove the 6 bolts.

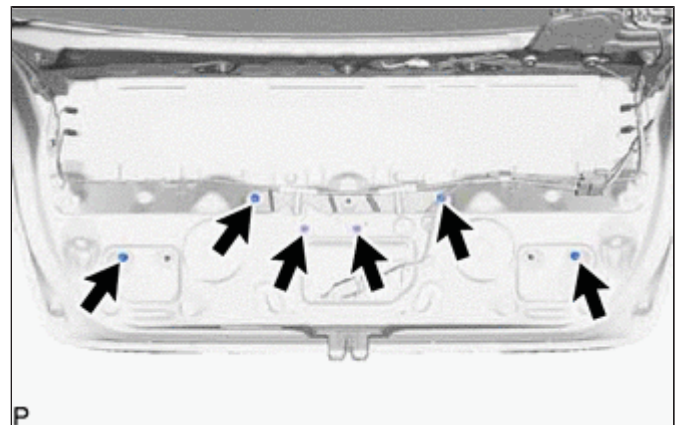

(b) Disengage the 13 clips as shown in the illustration to remove the back door outside garnish sub-assembly.

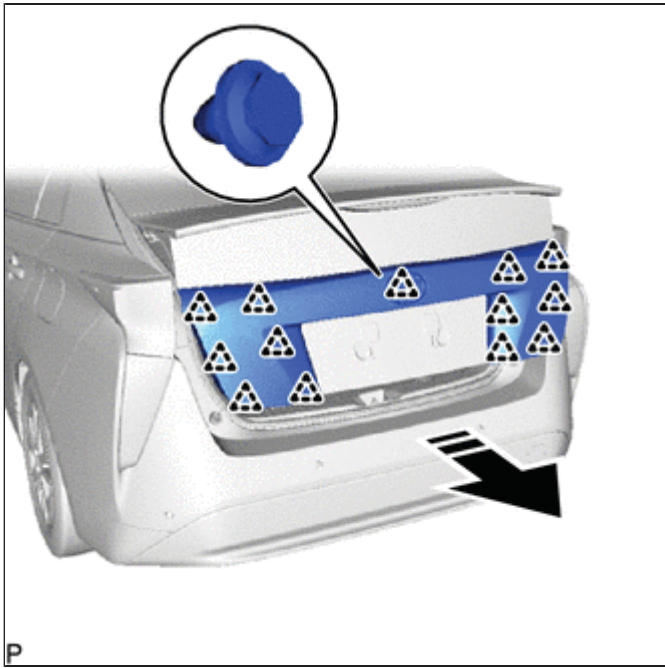

P



Remove in this Direction

